

STATE OF ILLINOIS
DEPARTMENT OF TRANSPORTATION
DIVISION OF HIGHWAYS

**PROPOSED
HIGHWAY PLANS**

FAU ROUTE 1376 : GRAND AVE.
DUPAGE COUNTY LINE TO US 12/45 (MANNHEIM RD.)
SECTION 3059A-RS-1
RESURFACING
COOK COUNTY
C-91-546-09

F.A.U. RTE.	SECTION	COUNTY	TOTAL SHEETS	SHEET NO.
1376	3059A-RS-1	COOK	20	1
		ILLINOIS	CONTRACT NO. 60G90	

FOR INDEX OF SHEETS, SEE SHEET NO. 2

IMPROVEMENT IS LOCATED IN THE VILLAGES OF FRANKLIN PARK AND NORTHLAKE

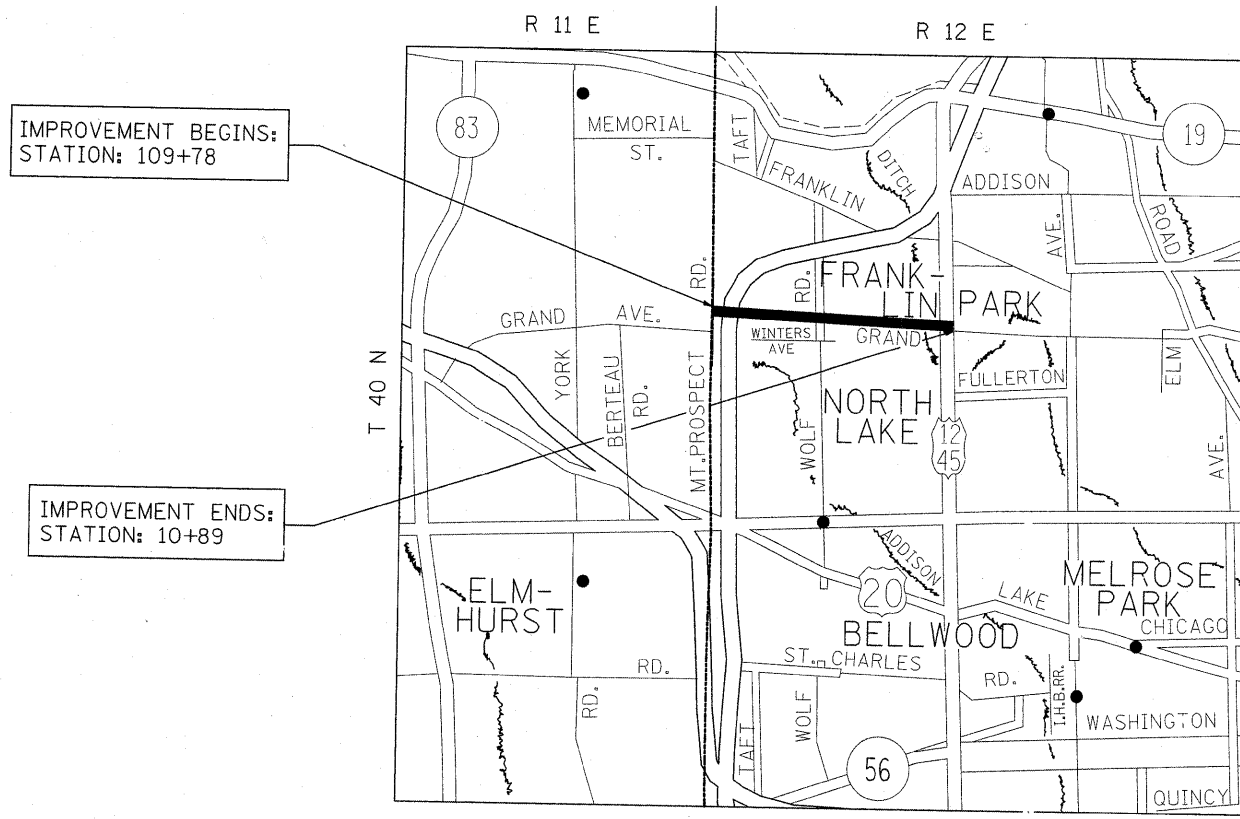
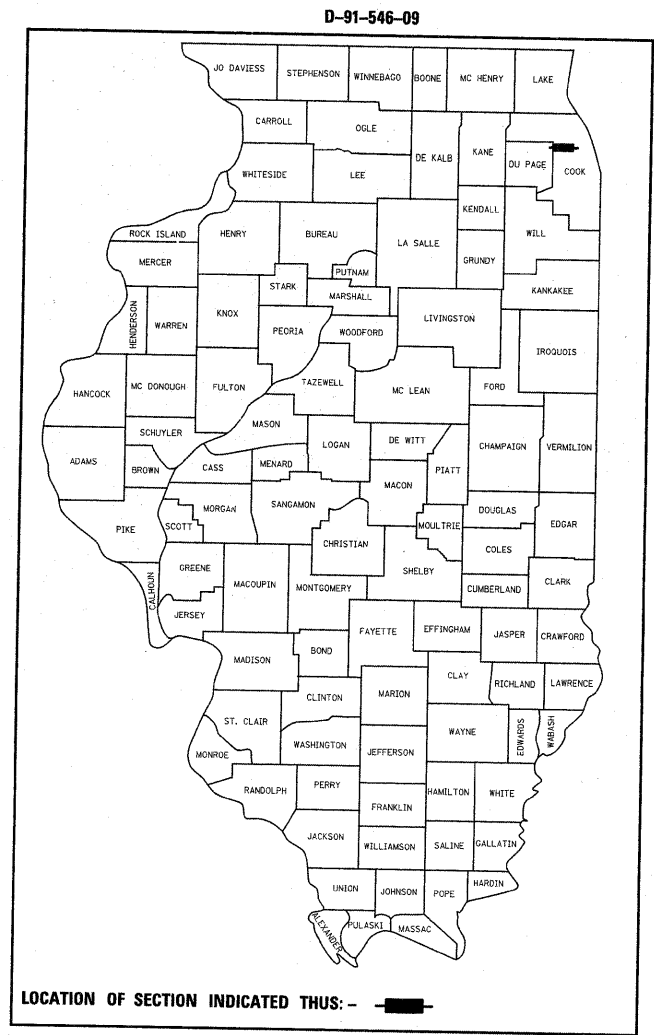

IMPROVEMENT BEGINS:
STATION: 109+78

IMPROVEMENT ENDS:
STATION: 10+89



TRAFFIC DATA:
2006 ADT = 31,000
SPEED LIMIT = 30 MPH

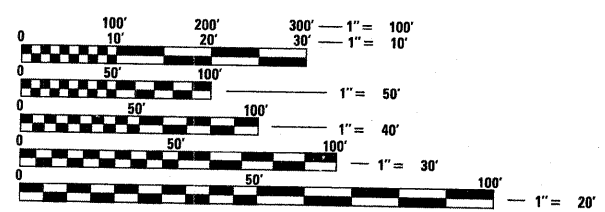

FULL SIZE PLANS HAVE BEEN PREPARED USING STANDARD ENGINEERING SCALES. REDUCED SIZED PLANS WILL NOT CONFORM TO STANDARD SCALES. IN MAKING MEASUREMENTS ON REDUCED PLANS, THE ABOVE SCALES MAY BE USED.

J.U.L.I.E.
JOINT UTILITY LOCATION INFORMATION FOR EXCAVATION
1-800-892-0123
OR 811

PROJECT ENGINEER: JOSE DOMINGUEZ (847) 705-4385
PROJECT MANAGER: KEN ENG
CONTRACT NO. 60G90

GROSS AND NET LENGTH OF IMPROVEMENT = 9,889 FEET = 1.87 MILES

STATE OF ILLINOIS
DEPARTMENT OF TRANSPORTATION
DIVISION OF HIGHWAYS

SUBMITTED APRIL 16, 20 09

Diana M. O'Keefe
DEPUTY DIRECTOR OF HIGHWAYS, REGION ENGINEER

May 1, 20 09
Charles G. Ingersoll
ENGINEER OF DESIGN AND ENVIRONMENT

May 1, 20 09
Christine M. Reed
DIRECTOR OF HIGHWAYS, CHIEF ENGINEER

**PRINTED BY THE AUTHORITY
OF THE STATE OF ILLINOIS**

INDEX OF SHEETS

STATE STANDARDS

GENERAL NOTES

<u>SHEET NO.</u>	<u>DESCRIPTION</u>
1	TITLE SHEET
2	INDEX OF SHEETS, STATE STANDARDS & GENERAL NOTES
3	SUMMARY OF QUANTITIES
4	EXISTING AND PROPOSED TYPICAL SECTIONS
5-9	ROADWAY AND PAVEMENT MARKING PLANS
*	DETECTOR LOOP REPLACEMENT PLANS
10	DETAILS FOR FRAME AND LIDS ADJUSTMENT WITH MILLING (BD-08)
11	PAVEMENT PATCHING FOR HMA SURFACED PAVEMENT (BD-22)
12	CURB OR CURB AND GUTTER REMOVAL AND REPLACEMENT (BD-24)
13	BUTT JOINT AND HMA TAPER (BD-32)
14	TRAFFIC CONTROL AND PROTECTION FOR SIDE ROADS, INTERSECTIONS AND DRIVEWAYS (TC-10)
15	TYPICAL APPLICATIONS: RAISED REFLECTIVE PAVEMENT MARKERS (SNOW-PLOW RESISTANT) (TC-11)
16	DISTRICT ONE TYPICAL PAVEMENT MARKINGS (TC-13)
17	TRAFFIC CONTROL AND PROTECTION AT TURN BAYS (TO REMAIN OPEN TO TRAFFIC) (TC-14)
18	PAVEMENT MARKING LETTERS AND SYMBOLS FOR TRAFFIC STAGING (TC-16)
19	ARTERIAL INFORMATION SIGNING (TC-22)
20	DISTRICT 1 DETECTOR LOOP INSTALLATION DETAILS FOR ROADWAY RESURFACING (TS-07)

<u>STANDARD NO.</u>	<u>DESCRIPTION</u>
000001-05	TYPICAL SYMBOLS, ABBREVIATIONS AND PATTERNS
442201-03	CLASS C AND D PATCHES
604091-02	FRAME AND GRATE TYPE 24
606001-04	CONCRETE CURB AND COMBINATION CONCRETE CURB AND GUTTER
701301-03	LANE CLOSURE, 2L, 2W, SHORT TIME OPERATIONS
701606-00	URBAN LANE CLOSURE, MULTILANE 2W WITH MOUNTABLE MEDIAN
701701-00	URBAN LANE CLOSURE, MULTILANE INTERSECTION
701901-01	TRAFFIC CONTROL DEVICES
886001-01	DETECTOR LOOP INSTALLATION
886006-01	TYPICAL LAYOUT FOR DETECTION LOOPS

BEFORE STARTING ANY EXCAVATION, THE CONTRACTOR SHALL CALL "JULIE" AT (800) 892-0123 OR 811 FOR FIELD LOCATIONS OF BURIED ELECTRIC, TELEPHONE, AND GAS FACILITIES. (48 HOUR NOTIFICATION REQUIRED)

THE CONTRACTOR WILL NOT BE ABLE TO SET UP A YARD OR FIELD OFFICE ON STATE PROPERTY WITHOUT THE WRITTEN PERMISSION OF THE DEPARTMENT.

THE CONTRACTOR SHALL COORDINATE CONSTRUCTION ACTIVITIES WITH UTILITY COMPANIES AND THE VILLAGES OF FRANKLIN PARK AND NORTHLAKE.

BUTT JOINTS WILL BE INSTALLED AT THE ENDS OF RESURFACING (WHERE RESURFACING MEETS EXISTING PAVEMENT) IN ACCORDANCE WITH THE "BUTT JOINT AND HMA TAPER DETAILS" SHEET INCLUDED IN THE PLANS UNLESS OTHERWISE SPECIFIED.

WHEN MILLED PAVEMENT IS OPEN TO TRAFFIC, THE MAXIMUM GRADE DIFFERENTIAL BETWEEN PASSES OF THE MILLING MACHINE SHALL NOT EXCEED 1/2 INCHES WHERE THE SPEED LIMIT IS 45 MPH OR LESS, AND 1 INCH WHERE THE SPEED LIMIT IS OVER 45 MPH. WITH WRITTEN APPROVAL FROM THE RESIDENT ENGINEER, A MAXIMUM GRADE DIFFERENTIAL OF 3 INCHES MAY BE ALLOWED IF THE EDGE OF THE MILLING IS SLOPED A MINIMUM OF 1:3 (V:H).

WHEN ARTIFICIAL LIGHTING IS UTILIZED IN NIGHT OPERATIONS, THE CONTRACTOR SHALL EXERCISE THE UTMOST PRECAUTIONS IN PREVENTING ADVERSE VISIBILITY TO THE MOTORING PUBLIC AND ADJOINING RESIDENTIAL AREAS.

ALL PAVEMENT PATCHING LOCATIONS WILL BE DETERMINED IN THE FIELD BY THE ENGINEER.

BEFORE BEGINNING ANY WORK, THE CONTRACTOR SHALL RETAIN AND RECORD FOR FUTURE REFERENCE, ALL EXISTING PAVEMENT MARKING LINES (AND RAISED REFLECTIVE PAVEMENT MARKERS) IN ORDER THAT THESE LOCATIONS CAN BE RE-ESTABLISHED FOR STRIPING. EXACT LOCATIONS OF ALL PAVEMENT MARKINGS SHALL BE AS DIRECTED BY THE ENGINEER.

DOUBLE LANE MARKERS ARE TO BE USED AS SHOWN ON THE DISTRICT ONE DETAIL "TYPICAL APPLICATIONS - RAISED REFLECTIVE PAVEMENT MARKERS (SNOW-PLOW RESISTANT)" SHOWN IN THE PLANS.

THE RESIDENT ENGINEER SHALL CONTACT MR. WALLY CZARNY, AREA TRAFFIC FIELD ENGINEER, AT (773) 685-8386 A MINIMUM OF 2 WEEKS PRIOR TO PLACEMENT OF FINAL PAVEMENT MARKINGS.

THE RESIDENT ENGINEER SHALL CONTACT THE TRAFFIC CONTROL SUPERVISOR AT (847) 705-4470 A MINIMUM OF 72 HOURS PRIOR TO THE INSTALLATION OF ANY TEMPORARY TRAFFIC CONTROL DEVICES.

* TO BE PROVIDED AT A LATER DATE

FILE NAME =	USER NAME = ansaris	DESIGNED -	REVISED -	STATE OF ILLINOIS DEPARTMENT OF TRANSPORTATION	GRAND AVE. (DUPAGE CO. LINE TO US 1245 INDEX OF SHEETS, STATE STANDARDS AND GENERAL NOTES	F.A.U. RTE.	SECTION	COUNTY	TOTAL SHEETS	SHEET NO.
ct\pw_work\PIWIDOT\ANSARIS\0137611\0154609-shr-plan.dgn	DRAWN -	REVISED -	1376			3059A-RS-1	COOK	20	2	
PLOT SCALE = 50.0000' / IN.	CHECKED -	REVISED -	CONTRACT NO. 60690							
PLOT DATE = 4/16/2009	DATE -	REVISED -	FED. ROAD DIST. NO. 1 ILLINOIS FED. AID PROJECT							
				SCALE:		SHEET NO. OF SHEETS		STA. TO STA.		

SUMMARY OF QUANTITIES				CONSTRUCTION TYPE CODE					SUMMARY OF QUANTITIES				CONSTRUCTION TYPE CODE				
CODE NO	ITEM	UNIT	TOTAL QUANTITIES	1000					CODE NO	ITEM	UNIT	TOTAL QUANTITIES	1000				
40600200	BITUMINOUS MATERIALS (PRIME COAT)	TON	31	31					70300260	TEMPORARY PAVEMENT MARKING - LINE 12"	FOOT	500	500				
40600300	AGGREGATE (PRIME COAT)	TON	141	141					70300280	TEMPORARY PAVEMENT MARKING - LINE 24"	FOOT	470	470				
40600400	MIXTURE FOR CRACKS, JOINTS, AND FLANGEWAYS	TON	22	22					70301000	WORK ZONE PAVEMENT MARKING REMOVAL	SQ FT	6150	6150				
40600895	CONSTRUCTING TEST STRIP	EACH	1	1					* 78000100	THERMOPLASTIC PAVEMENT MARKING - LETTERS AND SYMBOLS	SQ FT	875	875				
40600982	HOT-MIX ASPHALT SURFACE REMOVAL - BUTT JOINT	SQ YD	605	605					* 78000200	THERMOPLASTIC PAVEMENT MARKING - LINE 4"	FOOT	27300	27300				
40603595	POLYMERIZED HOT-MIX ASPHALT SURFACE COURSE, MIX "F", N90	TON	6880	6880					* 78000400	THERMOPLASTIC PAVEMENT MARKING - LINE 6"	FOOT	5700	5700				
42101300	PROTECTIVE COAT	SQ YD	1225	1225					* 78000600	THERMOPLASTIC PAVEMENT MARKING - LINE 12"	FOOT	500	500				
42400200	PORTLAND CEMENT CONCRETE SIDEWALK 5 INCH	SQ FT	500	500					* 78000650	THERMOPLASTIC PAVEMENT MARKING - LINE 24"	FOOT	470	470				
44000159	HOT-MIX ASPHALT SURFACE REMOVAL, 2 1/2"	SQ YD	70180	70180					* 78100100	RAISED REFLECTIVE PAVEMENT MARKER	EACH	900	900				
44000600	SIDEWALK REMOVAL	SQ FT	500	500					78300200	RAISED REFLECTIVE PAVEMENT MARKER REMOVAL	EACH	900	900				
44001700	COMBINATION CONCRETE CURB AND GUTTER REMOVAL AND REPLACEMENT	FOOT	3500	3500					* 88600600	DETECTOR LOOP REPLACEMENT	FOOT	1524	1524				
44201777	CLASS D PATCHES, TYPE II, 11 INCH	SQ YD	150	150					X0322256	TEMPORARY INFORMATION SIGNING	SQ FT	51.4	51.4				
44201781	CLASS D PATCHES, TYPE III, 11 INCH	SQ YD	300	300					X0656100	DRIVEWAY PAVEMENT REMOVAL AND REPLACEMENT	SQ YD	100	100				
44201783	CLASS D PATCHES, TYPE IV, 11 INCH	SQ YD	3000	3000					X4067107	POLYMERIZED LEVELING BINDER (MACHINE METHOD), IL-4.75, N50	TON	3036	3036				
55039700	STORM SEWERS TO BE CLEANED	FOOT	700	700					Z0018500	DRAINAGE STRUCTURES TO BE CLEANED	EACH	165	165				
60250200	CATCH BASINS TO BE ADJUSTED	EACH	5	5					Z0048665	RAILROAD PROTECTIVE LIABILITY INSURANCE	L SUM	1	1				
60252800	CATCH BASINS TO BE RECONSTRUCTED	EACH	2	2													
60255500	MANHOLES TO BE ADJUSTED	EACH	1	1													
60257900	MANHOLES TO BE RECONSTRUCTED	EACH	1	1													
60300305	FRAMES AND LIDS TO BE ADJUSTED	EACH	65	65													
60300310	FRAMES AND LIDS TO BE ADJUSTED (SPECIAL)	EACH	165	165													
60404950	FRAMES AND GRATES, TYPE 24	EACH	65	65													
67000400	ENGINEER'S FIELD OFFICE, TYPE A	CAL MO	6	6													
67100100	MOBILIZATION	L SUM	1	1													
70102625	TRAFFIC CONTROL AND PROTECTION, STANDARD 701606	L SUM	1	1													
70102635	TRAFFIC CONTROL AND PROTECTION, STANDARD 701701	L SUM	1	1													
70300100	SHORT-TERM PAVEMENT MARKING	FOOT	18500	18500													
70300210	TEMPORARY PAVEMENT MARKING - LETTERS AND SYMBOLS	SQ FT	875	875													
70300220	TEMPORARY PAVEMENT MARKING - LINE 4"	FOOT	27300	27300													
70300240	TEMPORARY PAVEMENT MARKING - LINE 6"	FOOT	5700	5700													

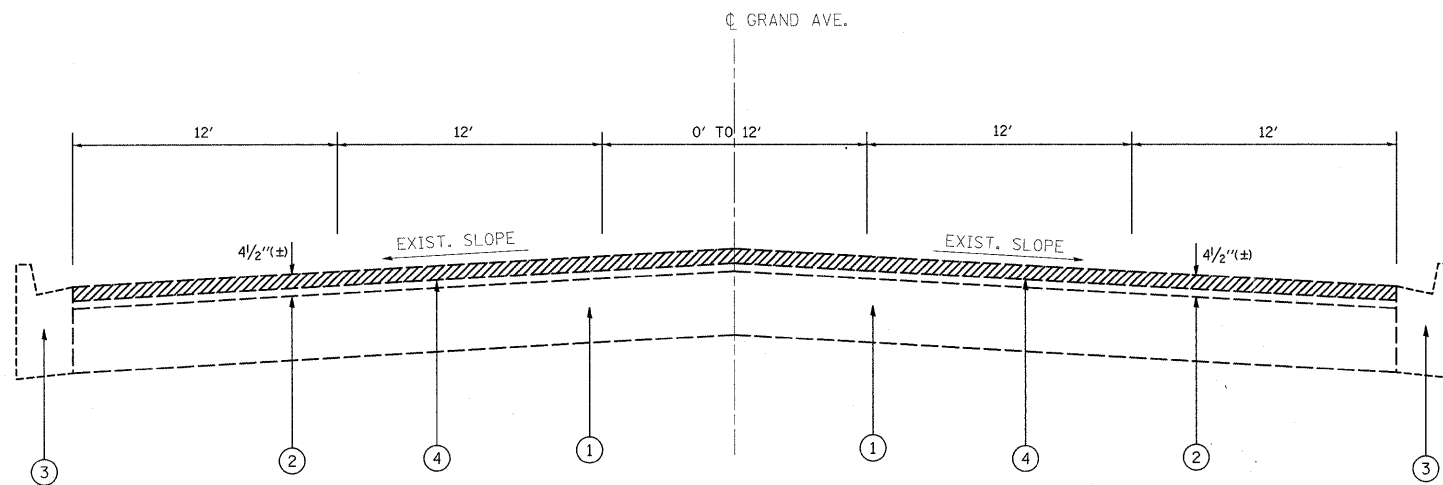

EXISTING TYPICAL SECTION
GRAND AVENUE

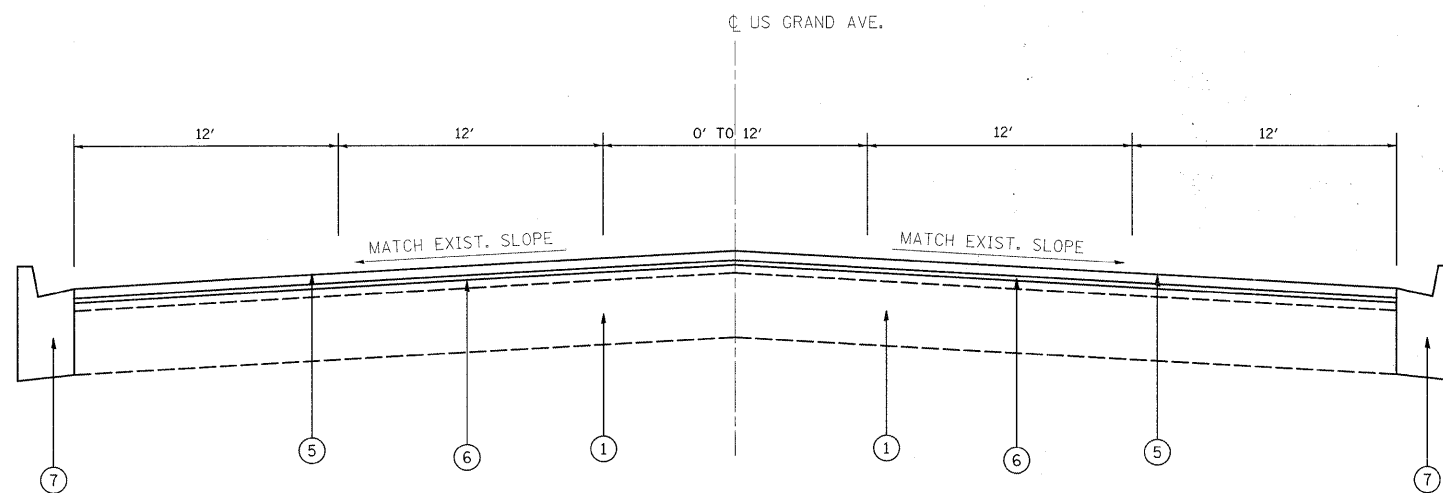

PROPOSED TYPICAL SECTION
GRAND AVENUE

LEGEND

- ① EXIST. PCC BASE COURSE, 9''(±)
- ② EXIST. HOT-MIX ASPHALT SURFACE COURSE (BEFORE MILLING), 4 1/2''(±)
- ③ EXIST. CONCRETE CURB AND GUTTER
- ④ PROP. HOT-MIX ASPHALT SURFACE REMOVAL - 2 1/2''
(2'' OF HOT-MIX ASPHALT TO REMAIN)
- ⑤ PROP. POLYMERIZED HOT-MIX ASPHALT SURFACE COURSE, MIX "F",
N90, 1 3/4''
- ⑥ PROP. POLYMERIZED LEVELING BINDER (MM), IL-4.75, N50, 3/4''
- ⑦ PROP. CONCRETE CURB AND GUTTER REMOVAL AND REPLACEMENT
(LOCATIONS TO BE DETERMINED BY THE RESIDENT ENGINEER)

NOTES:

- 1. THE CONTRACTOR SHALL MILL FIRST BEFORE PATCHING

HOT-MIX ASPHALT MIXTURE REQUIREMENTS

	MIXTURE TYPE	AC TYPE	AIR VOIDS (%)
ROADWAY	POLYMERIZED HOT-MIX ASPHALT SURFACE COURSE, MIX "F", N90, (IL-9.5MM), 1 3/4 ''	SBS/SBR PG 70-22	4% @ 90 GYR
	POLYMERIZED LEVELING BINDER (MM), IL-4.75, N50, 3/4''	SBS/SBR PG 76-28/-22	4% @ 50 GYR
PATCHES	CLASS D PATCHES, (HMA BINDER IL-19.0 MM), 9''	PG 64-22*	4% @ 70 GYR
	HOT-MIX ASPHALT REPLACEMENT OVER PATCHES, (HMA BINDER IL-19.0 MM)	PG 64-22*	4% @ 70 GYR

THE UNIT WEIGHT USED TO CALCULATE ALL HOT-MIX ASPHALT SURFACE MIXTURE QUANTITIES IS 112 LBS/SQ YD/IN

* WHEN RAP EXCEEDS 20%, THE NEW ASPHALT BINDER IN THE MIX SHALL BE PG 58-22

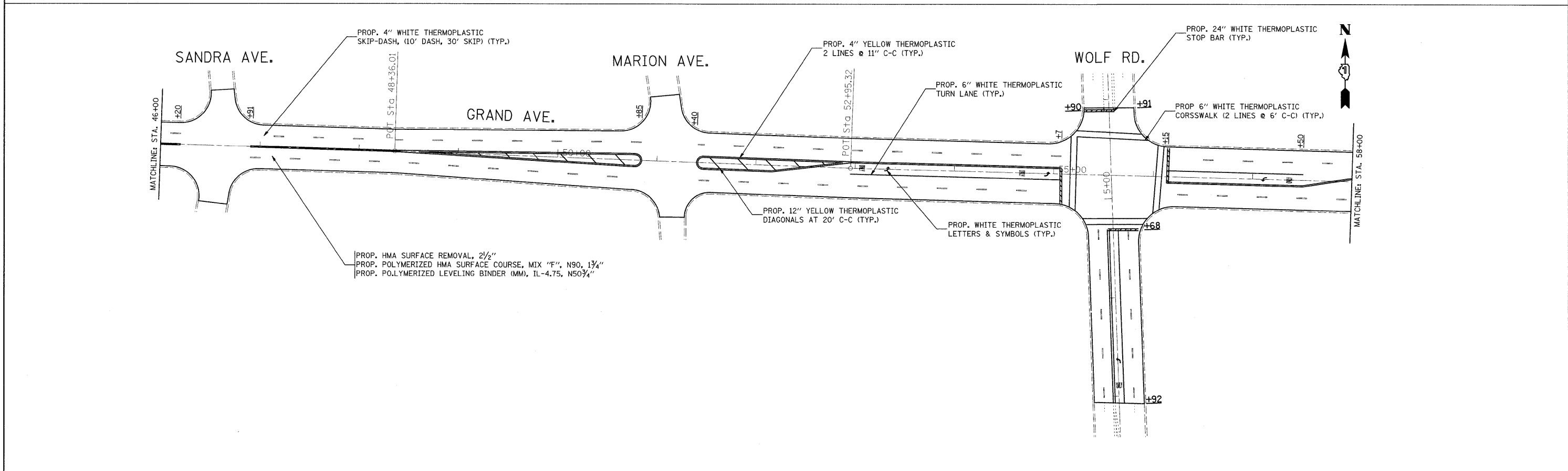
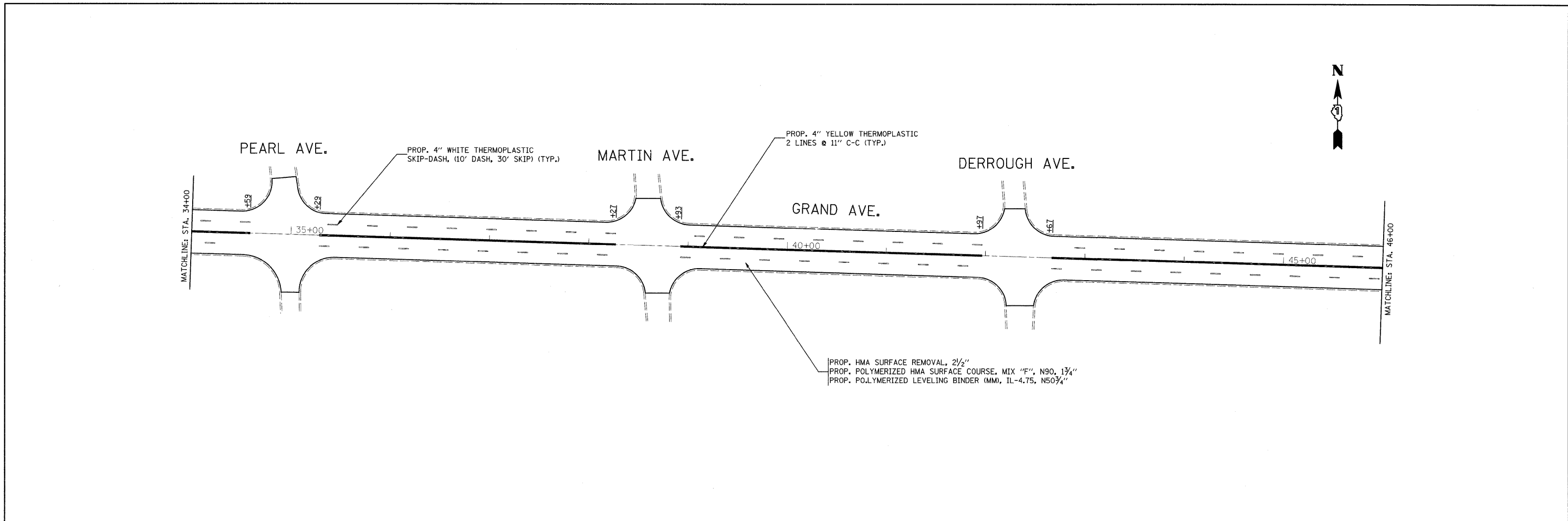

FILE NAME =	USER NAME = ansaris	DESIGNED -	REVISED -	STATE OF ILLINOIS DEPARTMENT OF TRANSPORTATION	GRAND AVE. (DUPAGE CO. LINE TO US 12/45) ROADWAY AND PAVEMENT MARKING PLAN	F.A.J. RTE.	SECTION	COUNTY	TOTAL SHEETS	SHEET NO.	
cr\pw_work\PWIDOT\ANSARIS\0137611\ND154609-sh1-plan.dgn		DRAWN -	REVISED -			1376	3059A-RS-1	COOK	20	6	
PLOT SCALE = 50.0000' / IN.		CHECKED -	REVISED -			CONTRACT NO. 60G90					
PLOT DATE = 4/16/2009		DATE -	REVISED -			ILLINOIS FED. AID PROJECT					

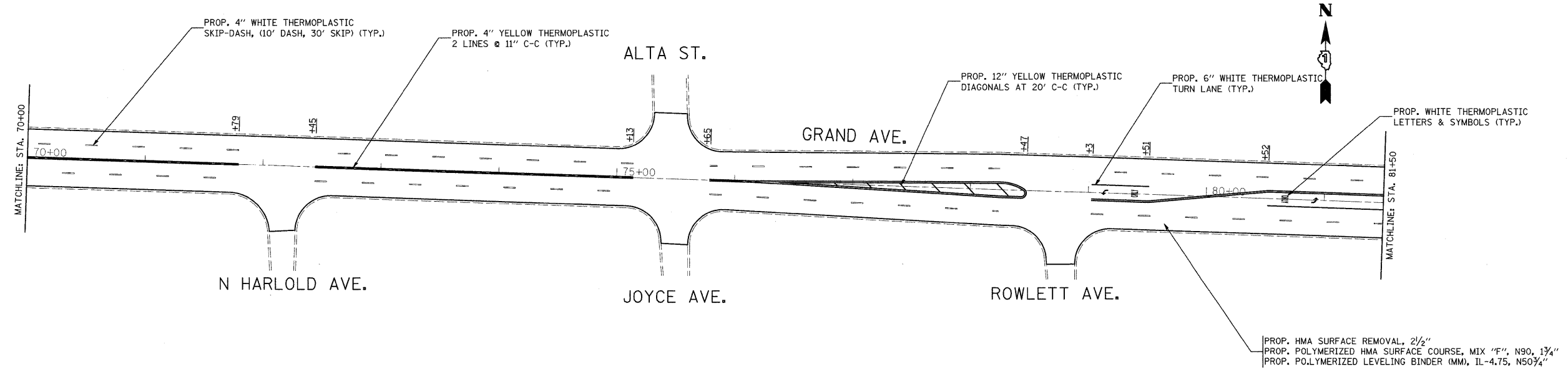
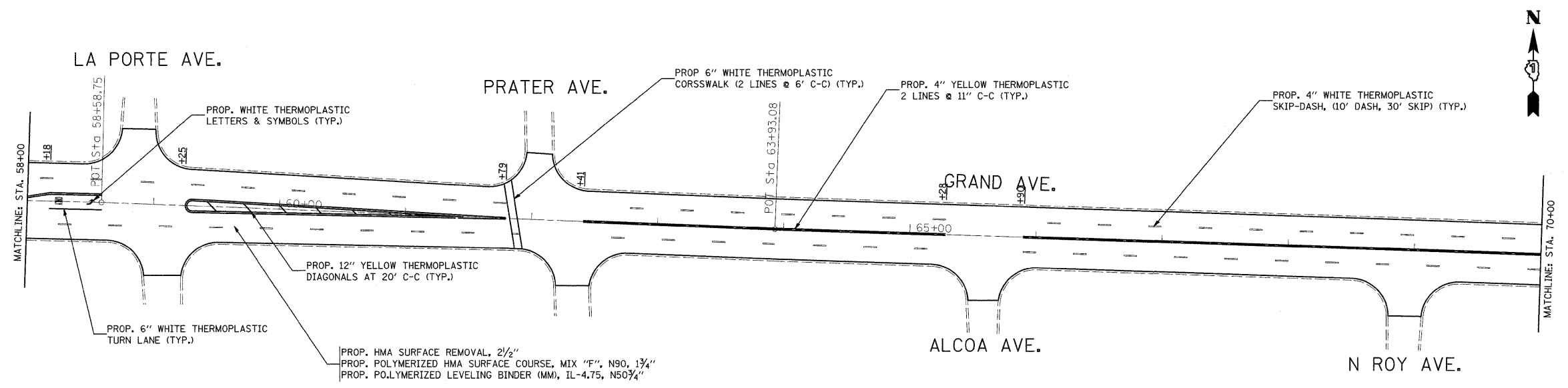

FILE NAME =
 c:\pwork\pwidot\ANSARIS\81376\1\0154609-sht-plan.dgn

USER NAME = ansaris
 PLOT SCALE = 50,0000' / IN.
 PLOT DATE = 4/16/2009

DESIGNED -
 DRAWN -
 CHECKED -
 DATE -

REVISED -
 REVISED -
 REVISED -
 REVISED -

**STATE OF ILLINOIS
 DEPARTMENT OF TRANSPORTATION**

**GRAND AVE. (DUPAGE CO. LINE TO US 1245)
 ROADWAY AND PAVEMENT MARKING PLAN**

SCALE: SHEET NO. OF SHEETS STA. TO STA.

F.A.U. RTE. 1376	SECTION 3059A-RS-1	COUNTY COOK	TOTAL SHEETS 20	SHEET NO. 7
CONTRACT NO. 60690				
ILLINOIS FED. AID PROJECT				

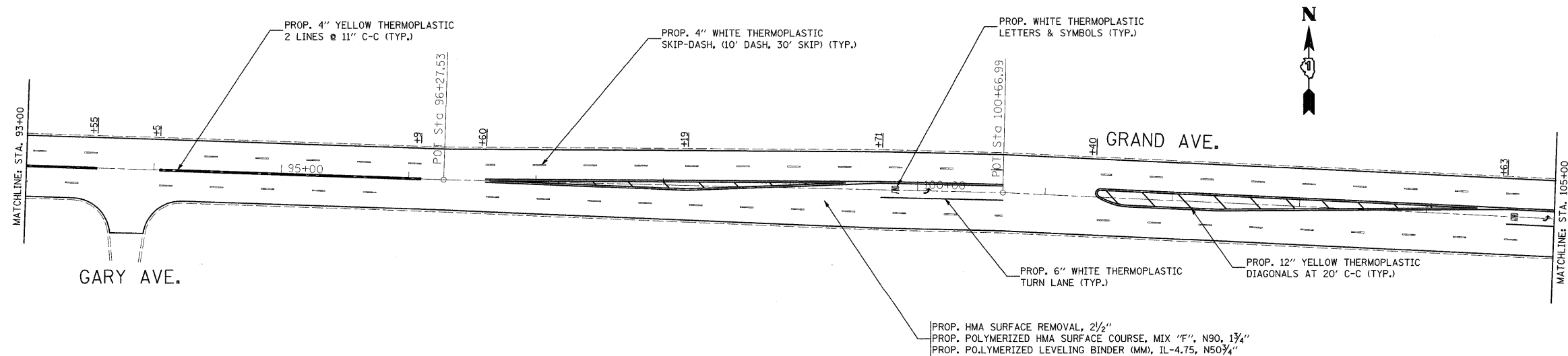
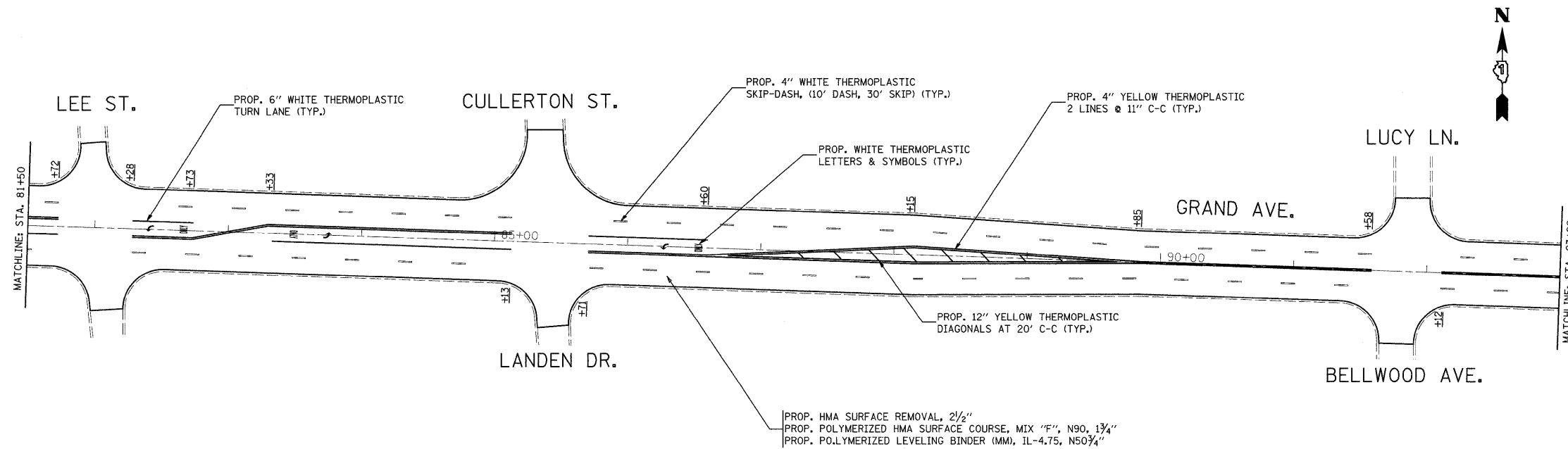

FILE NAME =
 c:\pwork\pwidot\ANSARIS\0137611\0154699-sht-plan.dgn

USER NAME = ansaris
 PLOT SCALE = 50,0000 / IN.
 PLOT DATE = 4/16/2009

DESIGNED -
 DRAWN -
 CHECKED -
 DATE -

REVISED -
 REVISED -
 REVISED -
 REVISED -

**STATE OF ILLINOIS
 DEPARTMENT OF TRANSPORTATION**

**GRAND AVE. (DUPAGE CO. LINE TO US 1245)
 ROADWAY AND PAVEMENT MARKING PLAN**

SCALE: SHEET NO. OF SHEETS STA. TO STA.

F.A.U. RTE. 1376	SECTION 3059A-RS-1	COUNTY COOK	TOTAL SHEETS 20	SHEET NO. 8
CONTRACT NO. 60G90				
ILLINOIS FED. AID PROJECT				

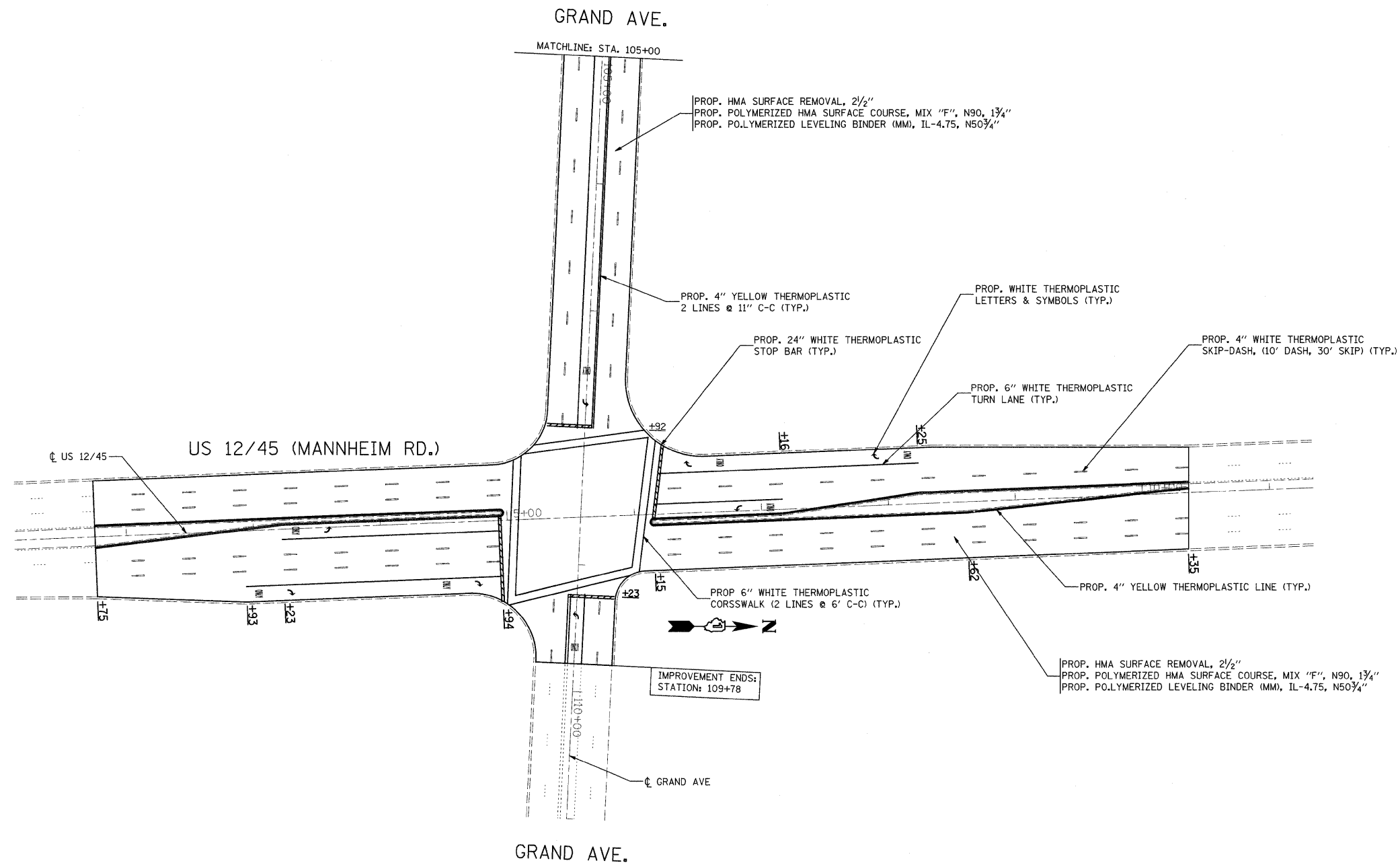

FILE NAME =	USER NAME = onsaris	DESIGNED -	REVISED -	STATE OF ILLINOIS DEPARTMENT OF TRANSPORTATION	GRAND AVE. (DUPAGE CO. LINE TO US 12/45) ROADWAY AND PAVEMENT MARKING PLAN	F.A.U. RTE.	SECTION	COUNTY	TOTAL SHEETS	SHEET NO.	
ct:\pw_work\PWIDOT\ANSARIS\d8137611\DI54629-sht-plen.dgn	PLOT SCALE = 50.0000' / IN.	DRAWN -	REVISED -			1376	3059A-RS-1	COOK	20	9	
PLOT DATE = 4/16/2009	DATE -	CHECKED -	REVISED -			CONTRACT NO. 60G90					
						ILLINOIS FED. AID PROJECT					

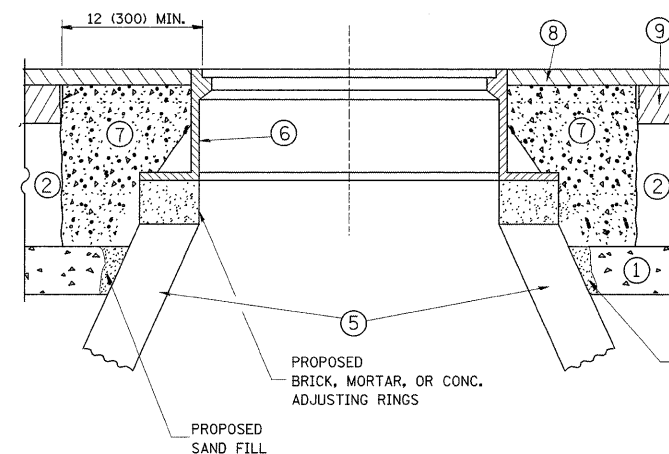
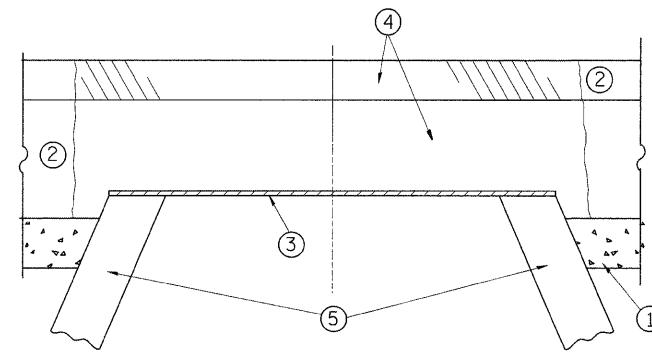

CONSTRUCTION PROCEDURES

STAGE 1 (BEFORE PAVEMENT MILLING)

- A) REMOVE A MINIMUM OF 12 (300) OF THE PAVEMENT FROM AROUND THE STRUCTURE.
- B) REMOVE THE EXISTING FRAME AND LID FROM THE STRUCTURE.
- C) COVER THE STRUCTURE OPENING WITH A 36 (900) DIAMETER METAL PLATE.
- D) BACKFILL WITH CRUSHED STONE AND A MINIMUM 1/2 (40) THICK HMA SURFACE MIX APPROVED BY THE ENGINEER.

STAGE 2 (AFTER PAVEMENT MILLING)

- A) REMOVE THE HMA SURFACE MIX AND CRUSHED STONE.
- B) INSTALL THE FRAME AND LID; ADJUST THE FRAME TO ITS FINAL SURFACE ELEVATION.
- C) THE SURROUNDING SPACE SHALL BE FILLED WITH CLASS SI CONCRETE, OR HMA SURFACE COURSE OR HMA BINDER COURSE TO THE ELEVATION OF THE SURFACE OF THE EXISTING BASE COURSE OR THE BINDER COURSE.

THE PROCEDURE EXPLAINED ABOVE SHALL CONFORM TO THE APPLICABLE PORTIONS OF SECTIONS 353, 406, 602, AND 603 OF THE STANDARD SPECIFICATIONS.

LEGEND

- ① SUB-BASE GRANULAR MATERIAL
- ② EXISTING PAVEMENT
- ③ 36 (900) DIAMETER METAL PLATE
- ④ PROPOSED CRUSHED STONE AND HMA SURFACE MIX
- ⑤ EXISTING STRUCTURE
- ⑥ FRAME AND LID (SEE NOTES)
- ⑦ CLASS SI CONCRETE, HMA SURFACE COURSE OR HMA BINDER COURSE
- ⑧ PROPOSED HMA SURFACE COURSE
- ⑨ PROPOSED HMA BINDER COURSE

NOTES:

EXISTING BROKEN FRAMES AND LIDS SHALL BE REMOVED AND DISPOSED OF BY THE CONTRACTOR AND SHALL BE REPLACED AS DIRECTED BY THE ENGINEER. REPLACEMENT FRAMES AND LIDS WILL BE PAID FOR IN ACCORDANCE WITH ARTICLE 109.04 OF THE STANDARD SPECIFICATIONS UNLESS A SEPARATE PAY ITEM HAS BEEN PROVIDED.

IF THE EXISTING LIDS ARE OPEN, THE FRAME WILL BE ADJUSTED TO THE ELEVATION OF THE MILLED PAVEMENT SURFACE PRIOR TO THE MILLING OPERATION. THE FRAME WILL NOT BE REMOVED AND COVERED BY THE METAL PLATE.

CITY OF CHICAGO CASTINGS ARE THE PROPERTY OF THE CITY AND THE CONTRACTOR SHALL NOTIFY THE CITY FOR REMOVAL AND DISPOSITION OF THE CASTINGS.

THE METAL PLATE USED TO COVER THE STRUCTURE SHALL REMAIN THE PROPERTY OF THE CONTRACTOR.

WHEN STRUCTURES ARE TO BE ADJUSTED OR RECONSTRUCTED, THE LOWERING AND RAISING OF THE FRAMES AND LIDS WILL NOT BE PAID FOR SEPARATELY BUT WILL BE INCLUDED IN THE COST OF THE CORRESPONDING PAY ITEM.

LOCATION OF STRUCTURES:

THE CONTRACTOR WILL BE REQUIRED TO KEEP A RECORD OF THE LOCATIONS OF THE BURIED STRUCTURES ACCORDING TO THE STATION AND DISTANCE LEFT OR RIGHT OF THE CENTERLINE OF PAVEMENT. UPON COMPLETION OF THE WORK, THE CONTRACTOR WILL DELIVER THE RECORD TO THE ENGINEER.

BASIS OF PAYMENT: THIS WORK WILL BE PAID FOR AT THE CONTRACT UNIT PRICE PER EACH FOR "FRAMES AND LIDS TO BE ADJUSTED, SPECIAL"

NEW FRAMES AND LIDS, WHEN SPECIFIED, WILL BE PAID FOR SEPARATELY.

DETAILS FOR FRAMES AND LIDS ADJUSTMENT WITH MILLING

ALL DIMENSIONS ARE IN INCHES (MILLIMETERS) UNLESS OTHERWISE SHOWN

FILE NAME =	USER NAME = onsaris	DESIGNED - R. SHAH	REVISED - R. SHAH 03-10-95	STATE OF ILLINOIS DEPARTMENT OF TRANSPORTATION	DETAILS FOR FRAMES AND LIDS ADJUSTMENT WITH MILLING			F.A.J. RTE. 1376	SECTION 3059A-RS-1	COUNTY COOK	TOTAL SHEETS 20	SHEET NO. 10
ci:\pw_work\pwidot\ensaris\2137611\DistS	.ldgn	DRAWN -	REVISED - A. ABBAS 03-21-97		SCALE: NONE	SHEET NO. 1 OF 1 SHEETS	STA. TO STA.	BD600-03 (BD-8)		CONTRACT NO. 60G90		
PLOT SCALE = 50.0000' / IN.		CHECKED -	REVISED - R. WIEDEMAN 05-14-04		FED. ROAD DIST. NO. 1 [ILLINOIS] FED. AID PROJECT							
PLOT DATE = 4/16/2009		DATE - 10-25-94	REVISED - R. BORO 01-01-07									

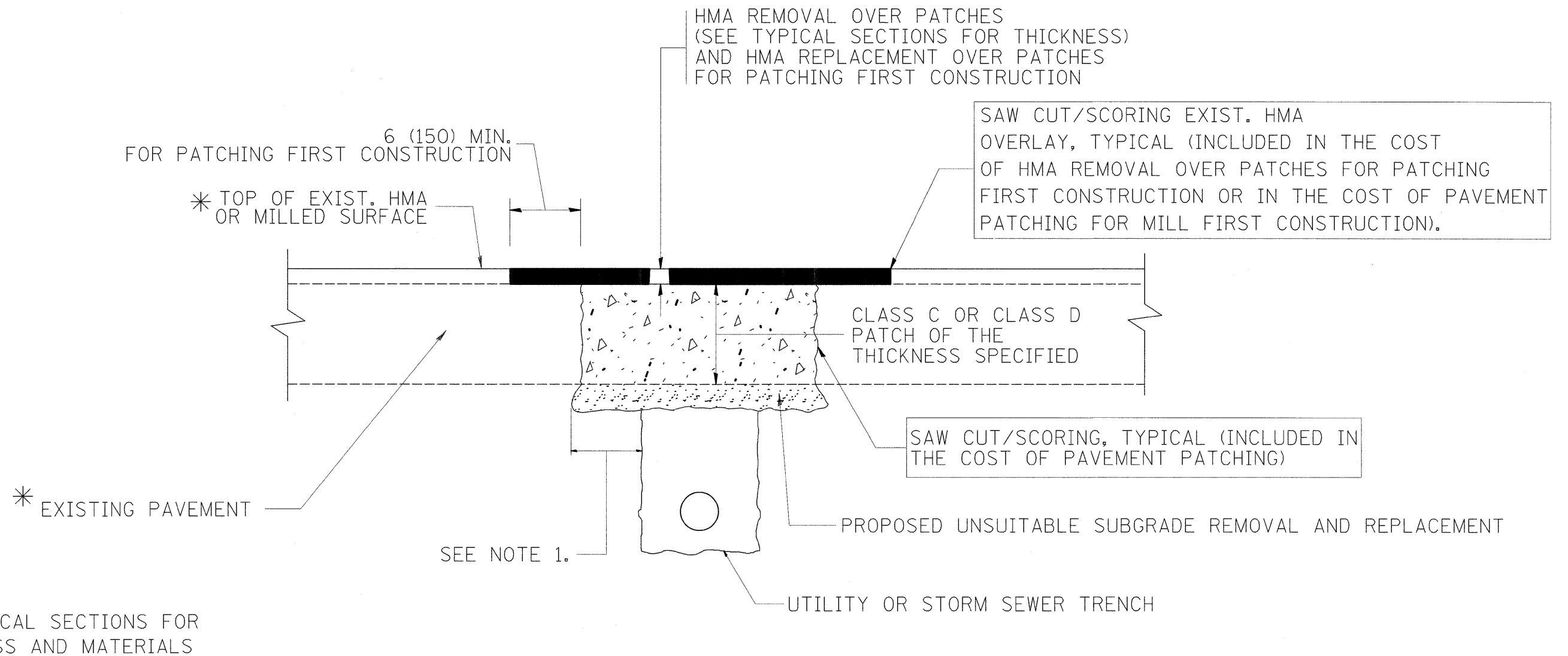

* SEE TYPICAL SECTIONS FOR THICKNESS AND MATERIALS

NOTES:

1. THE WIDTH OF THE FULL DEPTH PATCH OVER A TRENCH SHALL BE 12 (300) WIDER ON EACH SIDE OF THE TRENCH.
2. FOR METHOD OF MEASUREMENT AND BASIS OF PAYMENT, SEE RECURRING SPECIAL PROVISION "PATCHING WITH HOT-MIX ASPHALT OVERLAY REMOVAL".

SEQUENCE OF CONSTRUCTION (PATCHING FIRST)

1. REMOVE THE EXISTING HMA MATERIAL OVER THE AREA TO BE PATCHED.
2. REMOVE AND REPLACE WITH CLASS C OR D PATCH.
3. REPLACE HMA MATERIAL OVER THE AREA TO BE PATCHED.

SEQUENCE OF CONSTRUCTION (MILLING FIRST)

1. MILL HMA FIRST IF THERE IS AT LEAST 4 1/2 INCHES OR MORE OF HMA MATERIAL ON TOP OF THE EXISTING PAVEMENT OR IF THE PAVEMENT IS FULL DEPTH HMA. A MINIMUM OF 2 INCHES OF HMA MATERIAL SHALL BE IN PLACE AFTER MILLING.
2. REMOVE AND REPLACE WITH FULL DEPTH CLASS D PATCHES TO TOP OF MILLED SURFACE.

ALL DIMENSIONS ARE IN INCHES (MILLIMETERS) UNLESS OTHERWISE SHOWN.

FILE NAME =	USER NAME = anseris	DESIGNED - R. SHAH	REVISED - A. ABBAS 04-27-98	STATE OF ILLINOIS DEPARTMENT OF TRANSPORTATION	PAVEMENT PATCHING FOR HMA SURFACED PAVEMENT			F.A.U. RTE. 1376	SECTION 3059A-RS-1	COUNTY COOK	TOTAL SHEETS 20	SHEET NO. 11
ci:\pw_work\pwidot\anseris\ad137611\DistS	.dgn	DRAWN -	REVISED - R. BORO 01-01-07		SCALE: NONE	SHEET NO. 1 OF 1 SHEETS	STA.	TO STA.	BD400-04 (BD-22)		CONTRACT NO. 60G90	
	PLOT SCALE = 50.0000' / IN.	CHECKED -	REVISED - R. BORO 09-04-07		FED. ROAD DIST. NO. 1 ILLINOIS FED. AID PROJECT							
	PLOT DATE = 4/16/2009	DATE - 10-25-94	REVISED - K. ENG 10-27-08									

VARIABLE - TO MEET EXISTING DIMENSIONS AND FIELD CONDITIONS (SEE NOTE ②)

PROP. CONC. CURB OR CURB AND GUTTER REPLACEMENT IN ACCORDANCE WITH STATE STANDARD 606001. (SEE NOTE ②)

SAW CUT FULL DEPTH - INCLUDED IN THE COST OF SIDEWALK, DRIVEWAY OR MEDIAN SURFACE REMOVAL PAY ITEM.

SEE STATE STANDARD 606001
EXISTING OR PROPOSED HMA SURFACE (IF APPLICABLE)

18" (450) MAX.

1/4" (5) **

EXISTING SIDEWALK, DRIVEWAY, MEDIAN SURFACE OR GROUND.

PROPOSED SIDEWALK, DRIVEWAY PAVEMENT, MEDIAN SURFACE OR SALT TOLERANT SOD AND TOP SOIL, 4" (100) SOD RESTORATION (SEE NOTE ①).

EXISTING CONCRETE PAVEMENT, CONCRETE BASE COURSE OR FLEXIBLE PAVEMENT

3" (75) MIN.

SUITABLE BACKFILL MATERIAL (INCLUDED IN THE COST OF CURB OR CURB AND GUTTER REMOVAL AND REPLACEMENT)

PROPOSED 3/4" (20) PREFORMED EXPANSION JOINT AT CONCRETE SIDEWALKS, DRIVEWAYS, AND MEDIANS. (INCLUDED IN THE COST OF CURB OR CURB AND GUTTER REMOVAL AND REPLACEMENT.)

* 3" (75) MINIMUM FROM TOP AND BOTTOM OF THE CONCRETE PAVEMENT OR BASE COURSE.

** IF THE FINAL SURFACE OF THE PAVEMENT IS CONCRETE, THE GUTTER IS TO BE FLUSH WITH THE PAVEMENT.

NOTE: ① SIDEWALK, DRIVEWAY PAVEMENT OR MEDIAN SURFACE SHALL BE SIMILAR TO THE MATERIAL BEING REMOVED AND WILL BE PAID FOR SEPARATELY.

SALT TOLERANT SOD AND TOP SOIL, 4" (100) RESTORATION WILL NOT BE PAID FOR SEPARATELY, BUT SHALL BE INCLUDED IN THE COST OF CURB OR CURB AND GUTTER REMOVAL AND REPLACEMENT.

② CURB OR CURB AND GUTTER REPLACEMENT SHALL MATCH THE SHAPE OF THE EXISTING CURB OR CURB AND GUTTER UNLESS OTHERWISE SPECIFIED.

③ FOR CURB OR CURB AND GUTTER REMOVAL AND REPLACEMENT ADJACENT TO FLEXIBLE PAVEMENT DELETE EPOXY COATED TIE BARS.

④ LONGITUDINAL BARS, IF ENCOUNTERED IN THE EXISTING CURB OR CURB AND GUTTER, ARE NOT TO BE REPLACED. CUTTING AND REMOVING LONGITUDINAL BARS SHALL BE INCLUDED IN THE COST OF CURB OR CURB AND GUTTER REMOVAL AND REPLACEMENT.

⑤ THE COST OF HMA SURFACE REMOVAL IN THE EXISTING GUTTER FLAG SHALL BE INCLUDED IN THE COST OF THE CURB AND GUTTER REMOVAL AND REPLACEMENT.

⑥ THE REMOVAL AND REPLACEMENT OF THE EXISTING CURB OR CURB AND GUTTER SHALL BE DONE IN ACCORDANCE WITH THE APPLICABLE PORTIONS OF SECTION 440 AND 606 OF THE STANDARD SPECIFICATIONS.

⑦ THE LOCATIONS OF REMOVAL AND REPLACEMENT OF EXISTING CURB OR CURB AND GUTTER SHALL BE DETERMINED BY THE RESIDENT ENGINEER AT THE TIME OF CONSTRUCTION.

UNSUITABLE SUB-BASE MATERIAL TO BE REMOVED, IF DIRECTED BY THE ENGINEER, SHALL BE REPLACED WITH EITHER SUB-BASE GRANULAR MATERIAL, TYPE B OR ADDITIONAL THICKNESS OF CONCRETE.

REMOVAL AND REPLACEMENT 4" (100) OR LESS IS INCLUDED IN THE COST OF CURB OR CURB AND GUTTER REMOVAL AND REPLACEMENT.

REMOVAL AND REPLACEMENT IN EXCESS OF 4" (100) WILL BE PAID FOR IN ACCORDANCE WITH ARTICLE 109.04 OF THE STANDARD SPECIFICATIONS.

PROPOSED #6 (20) EPOXY COATED TIE BARS 24" (600) LONG AT 24" (600) CENTERS WILL NOT BE PAID FOR SEPARATELY. DELETE EPOXY COATED TIE BARS IF EXISTING TIE BARS ARE USABLE AS DETERMINED BY THE ENGINEER. (SEE NOTE ③).

BASIS OF PAYMENT:
THIS WORK WILL BE PAID FOR AT THE CONTRACT UNIT PRICE PER FOOT (METER) FOR "CURB REMOVAL AND REPLACEMENT" OR "COMBINATION CONCRETE CURB AND GUTTER REMOVAL AND REPLACEMENT".

CURB OR CURB AND GUTTER REMOVAL AND REPLACEMENT

ALL DIMENSIONS ARE IN INCHES (MILLIMETERS) UNLESS OTHERWISE SHOWN.

FILE NAME =	USER NAME = ansaris	DESIGNED - A. HOUSEH	REVISED - R. SHAH 10-03-96	STATE OF ILLINOIS DEPARTMENT OF TRANSPORTATION	CURB OR CURB AND GUTTER REMOVAL AND REPLACEMENT	F.A.U. RTE. 1376	SECTION 3059A-RS-1	COUNTY COOK	TOTAL SHEETS 20	SHEET NO. 12	
ct:\pw_work\pwsdot\ansaris\08137611\DistSched.dgn	PLOT SCALE = 5/8" (16) = 1" IN.	DRAWN -	REVISED - A. ABBAS 03-21-97			SCALE: NONE	SHEET NO. 1 OF 1 SHEETS	STA. TO STA.	BD600-06 (BD-24)		CONTRACT NO. 60G90
	PLOT DATE = 4/16/2009	CHECKED -	REVISED - M. GOMEZ 01-22-01			FED. ROAD DIST. NO. 1 ILLINOIS FED. AID PROJECT					
		DATE - 03-11-94	REVISED - R. BORO 01-01-07								

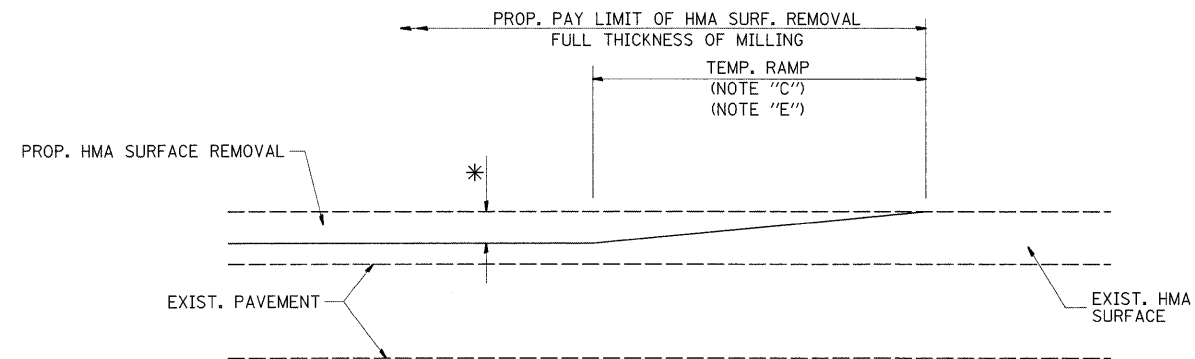

MILLED TEMPORARY RAMP
(FOR BUTT JOINT AND HMA TAPER SEE DETAIL BELOW)

OPTION 1

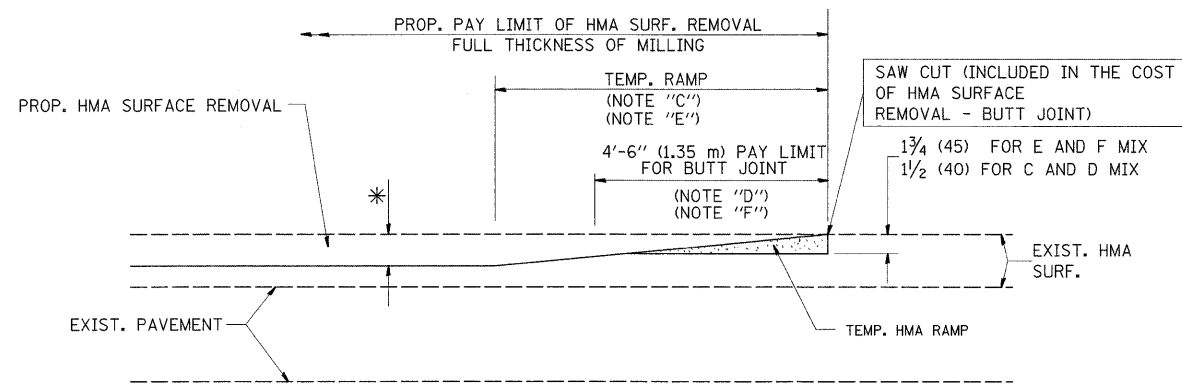

HMA CONSTRUCTED TEMPORARY RAMP
(FOR BUTT JOINT AND HMA TAPER SEE DETAIL BELOW)

OPTION 2
TYPICAL TEMPORARY RAMP

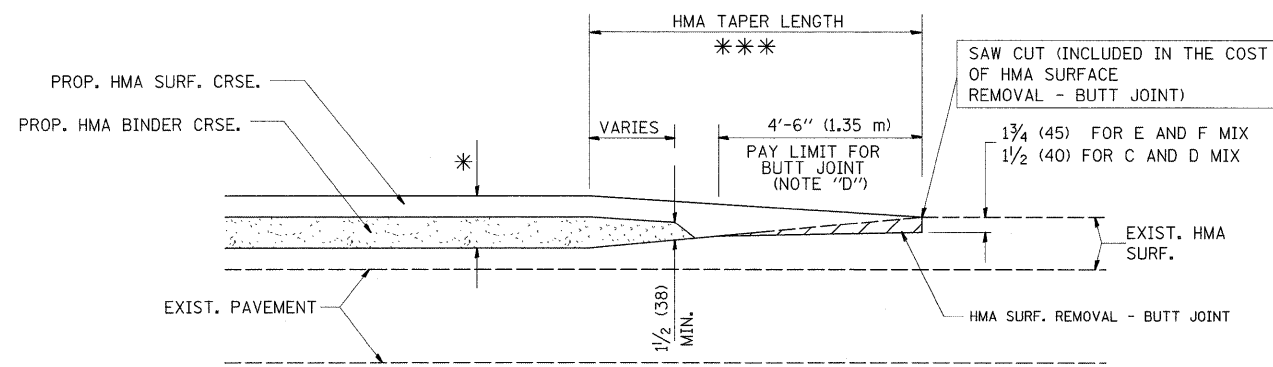

BUTT JOINT AND
HMA TAPER

**TYPICAL BUTT JOINT AND HMA TAPER
FOR MILLING AND RESURFACING**

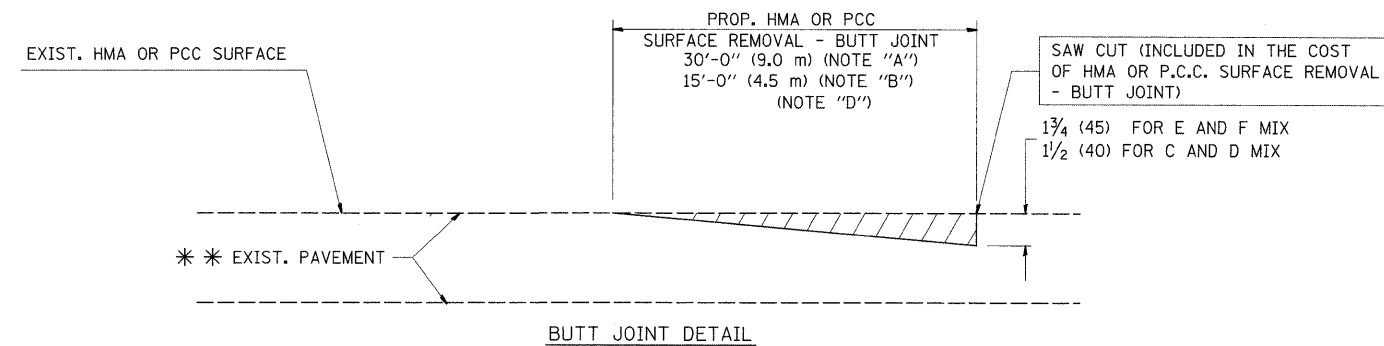

BUTT JOINT DETAIL

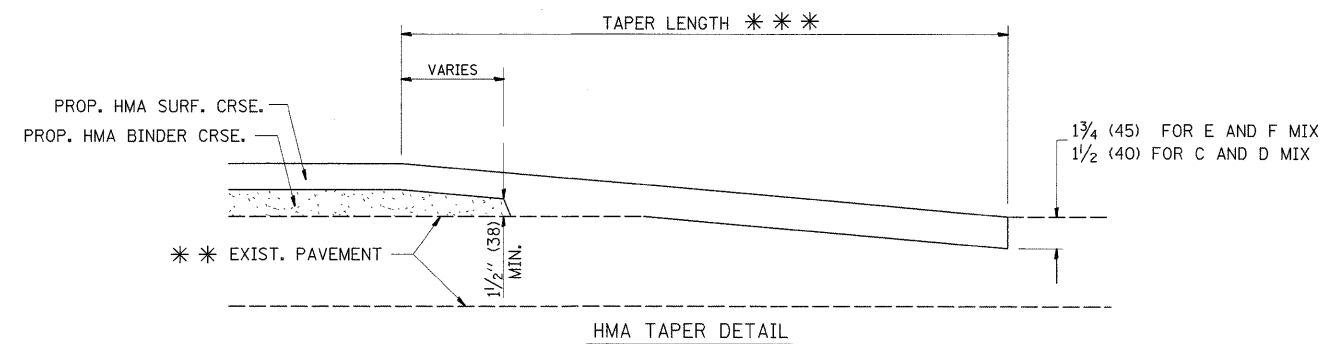

HMA TAPER DETAIL

**TYPICAL BUTT JOINT AND HMA TAPER
FOR RESURFACING ONLY**

*** PC CONCRETE, HMA OR HMA RESURFACED PAVEMENT.

NOTES

- A: MAINLINE ROADWAYS AND MAJOR SIDE ROADS.
 - B: MINOR SIDE ROADS.
 - C: THE TEMP. RAMP SHALL BE CONSTRUCTED IMMEDIATELY UPON REMOVAL OF THE EXISTING HMA SURFACE.
 - D: THE BUTT JOINT SHALL BE CONSTRUCTED IMMEDIATELY PRIOR TO PLACING THE PROPOSED HMA COURSES.
 - E: TAPER THE TEMP. RAMP AT A RATE OF 3'-0" (900 mm) PER 1 INCH (25 mm) OF MILLING THICKNESS.
 - F: INSTALLATION AND REMOVAL OF THE 4'-6" (1.35 m) TEMP. RAMP IS INCLUDED IN COST OF HMA SURFACE REMOVAL - BUTT JOINT
 - G: SEE ARTICLE 406.08 AND 406.14 OF THE STANDARD SPECIFICATIONS FOR "HMA AND/OR PCC SURFACE REMOVAL, BUTT JOINT".
- * SEE TYPICAL SECTIONS FOR MILLING THICKNESS.
- *** 20'-0" (6.1 m) PER 1 (25) RESURFACING (NOTE "A")
10'-0" (3.0 m) PER 1 (25) RESURFACING (NOTE "B")

BASIS OF PAYMENT:

THE BUTT JOINT WILL BE PAID FOR AT THE CONTRACT UNIT PRICE PER SQUARE YARD (SQUARE METER) FOR "HOT-MIX ASPHALT SURFACE REMOVAL - BUTT JOINT" OR FOR "PORTLAND CEMENT CONCRETE SURFACE REMOVAL - BUTT JOINT".

ALL DIMENSIONS ARE IN INCHES (MILLIMETERS) UNLESS OTHERWISE SHOWN.

FILE NAME =	USER NAME = ansaris	DESIGNED - M. DE YONG	REVISED - R. SHAH 10-25-94	STATE OF ILLINOIS DEPARTMENT OF TRANSPORTATION	BUTT JOINT AND HMA TAPER DETAILS		F.A.U. RTE. 1376	SECTION 3059A-RS-1	COUNTY COOK	TOTAL SHEETS 20	SHEET NO. 13
ci:\pwork\pwork\ansaris\0137611\DistSched.dgn		DRAWN -	REVISED - A. ABBAS 03-21-97		SCALE: NONE	SHEET NO. 1 OF 1 SHEETS	STA. TO STA.	BD400-05 BD32		CONTRACT NO. 60G90	
		CHECKED -	REVISED - M. GOMEZ 04-06-01		FED. ROAD DIST. NO. 1 ILLINOIS FED. AID PROJECT						
		DATE - 06-13-90	REVISED - R. BORO 01-01-07								

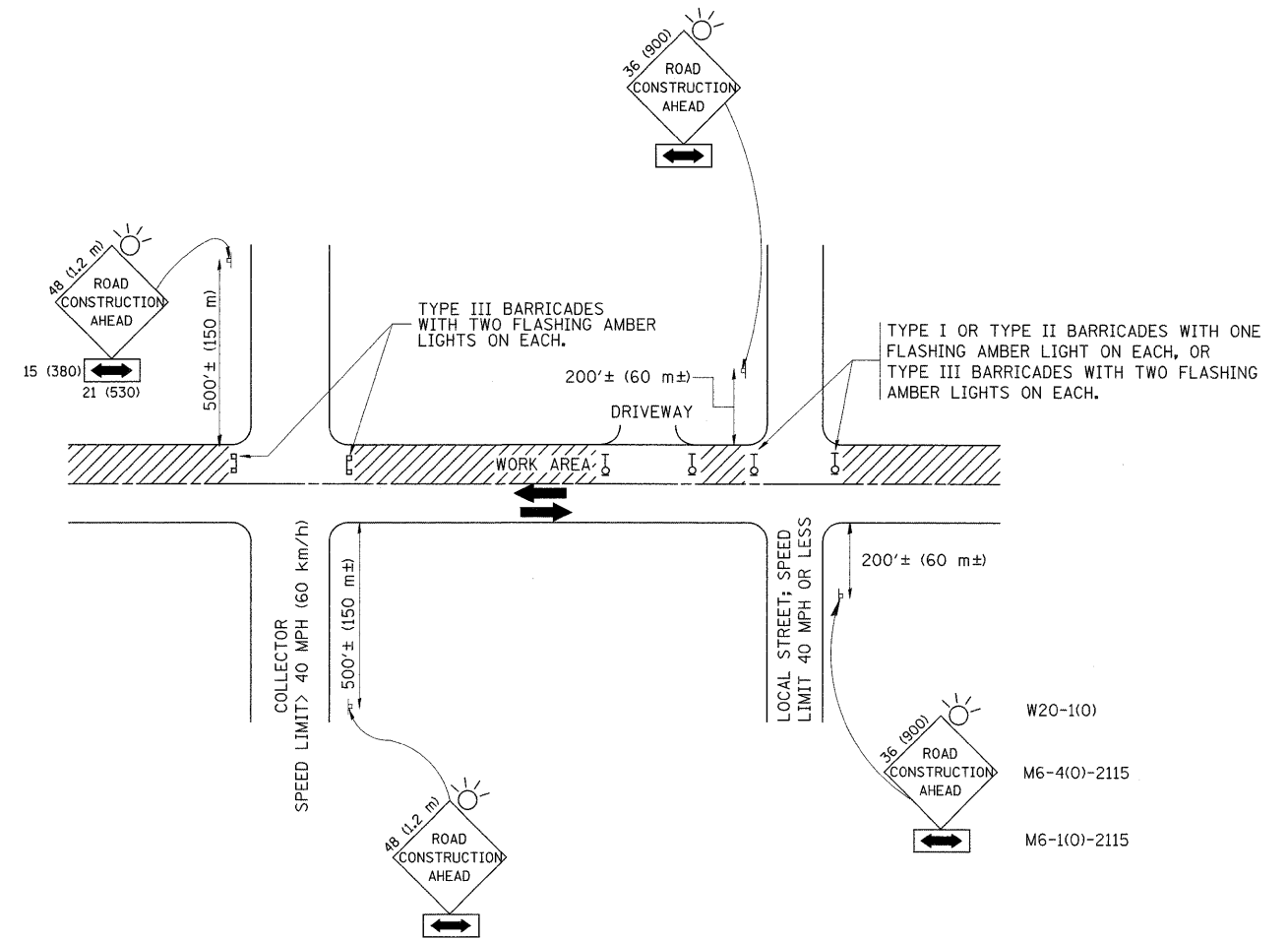

TRAFFIC CONTROL AND PROTECTION FOR SIDE ROADS, INTERSECTIONS, AND DRIVEWAYS

NOTES:

- A. FOR NO LANE RESTRICTION ON THE SIDE ROAD OR DRIVEWAYS
 - 1. SIDE ROAD WITH A SPEED LIMIT OF 40 MPH (60 km/h) OR LESS AS SHOWN ON THE DRAWING AND AS DIRECTED BY THE ENGINEER:
 - a) ONE ROAD CONSTRUCTION AHEAD SIGN 36 x 36 (900x900) WITH A FLASHER AND FLAG MOUNTED ON IT APPROXIMATELY 200' (60 m) IN ADVANCE OF THE MAIN ROUTE.
 - b) THE CLOSED PORTION OF THE MAIN ROUTE SHALL BE PROTECTED BY BLOCKING WITH TYPE I, TYPE II OR TYPE III BARRICADES, 1/3 OF THE CROSS SECTION OF THE CLOSED PORTION.
 - 2. SIDE ROAD WITH A SPEED LIMIT GREATER THAN 40 MPH (60 km/h) AS SHOWN ON THE DRAWING AND AS DIRECTED BY THE ENGINEER:
 - a) ONE ROAD CONSTRUCTION AHEAD SIGN 48 x 48 (1.2 m x 1.2 m) WITH A FLASHER MOUNTED ON IT APPROXIMATELY 500' (150 m) IN ADVANCE OF THE MAIN ROUTE.
 - b) THE CLOSED PORTION OF THE MAIN ROUTE SHALL BE PROTECTED BY BLOCKING WITH TYPE III BARRICADES, 1/2 OF THE CROSS SECTION OF THE CLOSED PORTION.
 - 3. WHEN THE SIDE ROAD LIES BETWEEN THE BEGINNING OF THE MAINLINE SIGNING AND THE WORK ZONE, A SINGLE HEADED ARROW (M6-1) SHALL BE USED IN LIEU OF THE DOUBLE HEADED ARROW (M6-4).
- B. FOR A LANE CLOSURE ON A SIDE ROAD OR DRIVEWAY:
 - USE APPLICABLE PORTIONS OF THE TYPICAL APPLICATION OF TRAFFIC CONTROL DEVICES (STD. 701501, STD. 701606 OR THE APPROPRIATE STANDARD). THE SPACING OF SIGNS AND BARRICADES SHALL BE ADJUSTED FOR FIELD CONDITIONS AS DIRECTED BY THE ENGINEER. THE DIRECTIONAL ARROW SHALL BE COVERED OR REMOVED WHEN NO LONGER CONSISTENT WITH THE SIDE ROAD LANE CLOSURE.
 - C. ADVANCE WARNING SIGNS ARE TO BE OMITTED ON DRIVEWAY UNLESS OTHERWISE NOTED.
 - D. THE TRAFFIC CONTROL AND PROTECTION FOR SIDE ROADS, INTERSECTIONS, AND DRIVEWAYS SHALL BE INCIDENTAL TO THE COST OF SPECIFIED TRAFFIC CONTROL STANDARDS OR ITEMS.

All dimensions are in millimeters (inches) unless otherwise shown.

FILE NAME =	USER NAME = onseris	DESIGNED - LHA	REVISED - J. OBERLE 10-18-95	STATE OF ILLINOIS DEPARTMENT OF TRANSPORTATION	TRAFFIC CONTROL AND PROTECTION FOR SIDE ROADS, INTERSECTIONS, AND DRIVEWAYS	F.A.J.J. RTE. 1376	SECTION 3059A-RS-1	COUNTY COOK	TOTAL SHEETS 20	SHEET NO. 14		
ct:\pw\work\pwwork\onsersis\08137611\DistS	edgn	DRAWN -	REVISED - A. HOUSEH 03-06-96			SCALE: NONE	SHEET NO. 1 OF 1 SHEETS	STA.	TO STA.	TC-10 CONTRACT NO. 60G90		
		CHECKED -	REVISED - A. HOUSEH 10-15-96									
		DATE - 06-89	REVISED - T. RAMMACHER 01-06-00									
				FED. ROAD DIST. NO. 1 ILLINOIS FED. AID PROJECT								

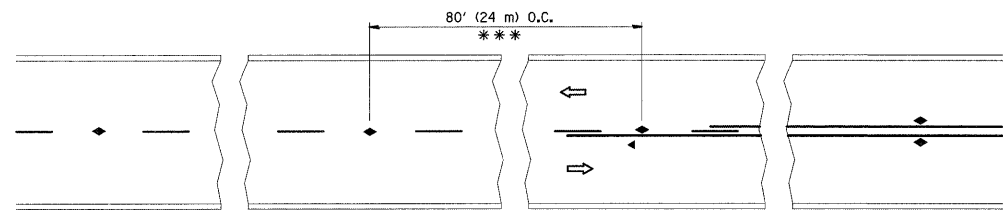

*** REDUCE TO 40' (12 m) O.C. ON CURVES WITH POSTED OR ADVISORY SPEED 45 M.P.H. (70 km/h) OR LESS.

TWO-LANE/TWO-WAY

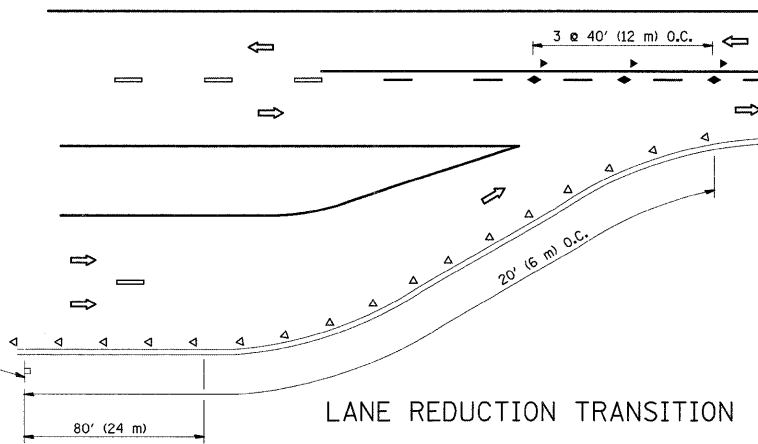

LANE REDUCTION TRANSITION

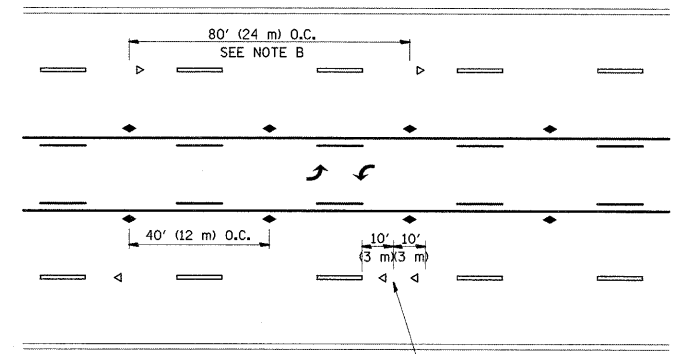

TWO-WAY LEFT TURN

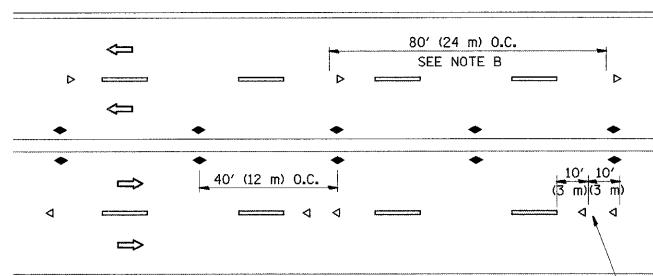

MULTI-LANE/UNDIVIDED

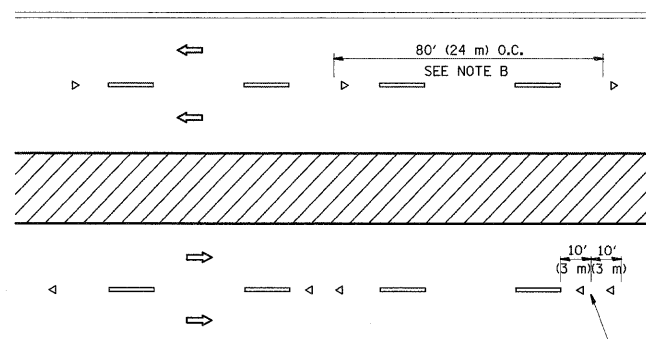

MULTI-LANE/DIVIDED

GENERAL NOTES

1. MARKERS USED WITH DASHED LINES SHALL BE CENTERED IN THE GAP BETWEEN SEGMENTS.
2. MARKERS USED ADJACENT TO SOLID LINES SHALL BE OFFSET 2 TO 3 (50 TO 75) TOWARD TRAFFIC AS SHOWN.
3. MARKERS THROUGH TANGENTS LESS THAN 500' (150 m) IN LENGTH BETWEEN CURVES SHALL BE INSTALLED AT THE LESSER OF THE TWO CURVE SPACINGS.

SYMBOLS

- YELLOW STRIPE
- WHITE STRIPE
- ◀ ONE-WAY AMBER MARKER
- ◁ ONE-WAY CRYSTAL MARKER (W/O)
- ◆ TWO-WAY AMBER MARKER

LANE MARKER NOTES

- B. REDUCE TO 40' (12 m) O.C. ON CURVES WHERE ADVISORY SPEEDS ARE 10 M.P.H. (20 km/h) LOWER THAN POSTED SPEEDS.
- A. USE DOUBLE LANE LINE MARKERS SPACED AS SHOWN.

DESIGN NOTES

1. DOUBLE LANE LINE MARKERS SHALL BE USED UNLESS SPECIFIED OTHERWISE.
2. EXCEPT AS SHOWN ON THE LANE REDUCTION TRANSITION AND FREEWAY EXIT RAMP DETAIL, MARKERS ARE NOT TO BE SPECIFIED ON RIGHT EDGE LINES.
3. THE EXACT MARKER LIMITS, SPACING, AND COLOR SHOULD BE INCLUDED IN THE PLANS.
4. MARKERS SHOULD NOT BE USED ALONGSIDE CURBS EXCEPT FOR EXTREMELY SHORT SECTIONS OF CURBS WHERE NOT MORE THAN TWO MARKERS WOULD BE INVOLVED.

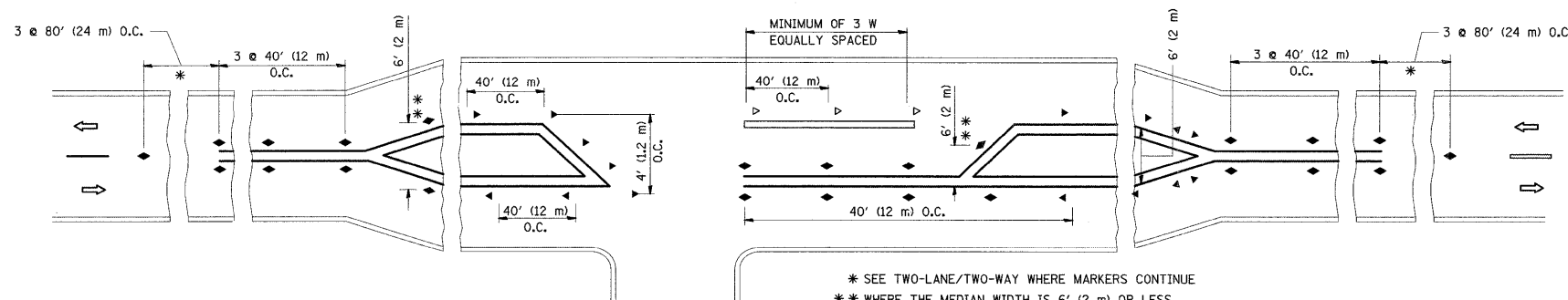

LEFT TURN

* SEE TWO-LANE/TWO-WAY WHERE MARKERS CONTINUE
 ** WHERE THE MEDIAN WIDTH IS 6' (2 m) OR LESS USE TWO-WAY MARKERS.

All dimensions are in inches (millimeters) unless otherwise shown.

FILE NAME =	USER NAME = ansaris	DESIGNED -	REVISED - T. RAMMACHER 09-19-94	STATE OF ILLINOIS DEPARTMENT OF TRANSPORTATION	TYPICAL APPLICATIONS RAISED REFLECTIVE PAVEMENT MARKERS (SNOW-PLOW RESISTANT)			F.A.U. RTE.	SECTION	COUNTY	TOTAL SHEETS	SHEET NO.
c:\pw_work\pwidot\ansaris\al0137611\DistS		DRAWN -	REVISED - T. RAMMACHER 03-12-99		1376	3059A-RS-1	COOK	20	15			
		CHECKED -	REVISED - T. RAMMACHER 01-06-00		TC-11			CONTRACT NO. 60690				
		DATE -	REVISED -		SCALE: NONE	SHEET NO. 1 OF 1 SHEETS	STA.	TO STA.	FED. ROAD DIST. NO. 1 [ILLINOIS] FED. AID PROJECT			

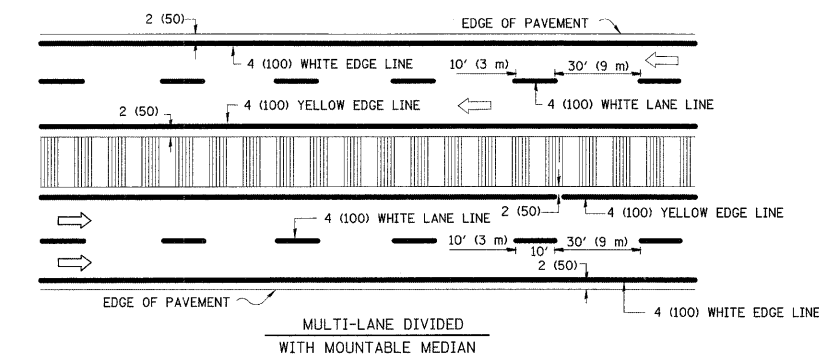
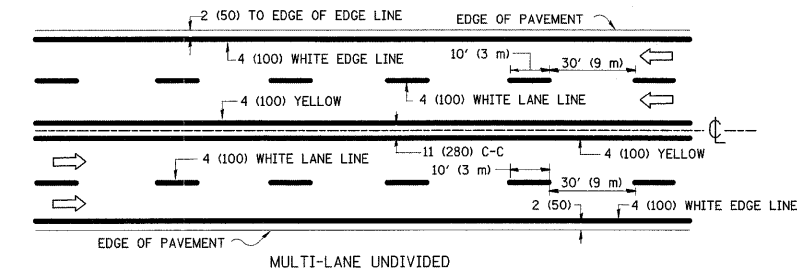
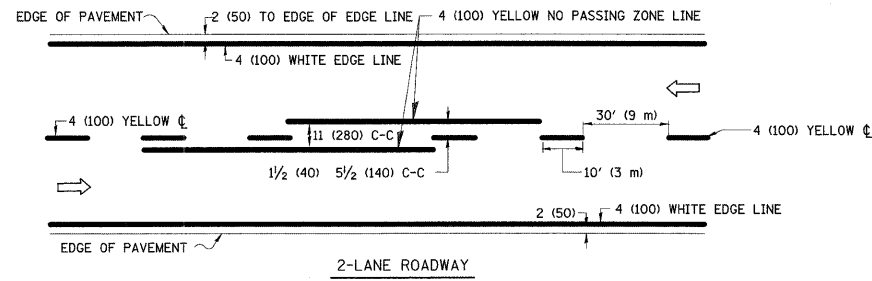

NOTE: MEDIANS WITH BARRIER CURB DO NOT REQUIRE AN EDGE LINE

TYPICAL LANE AND EDGE LINE MARKING

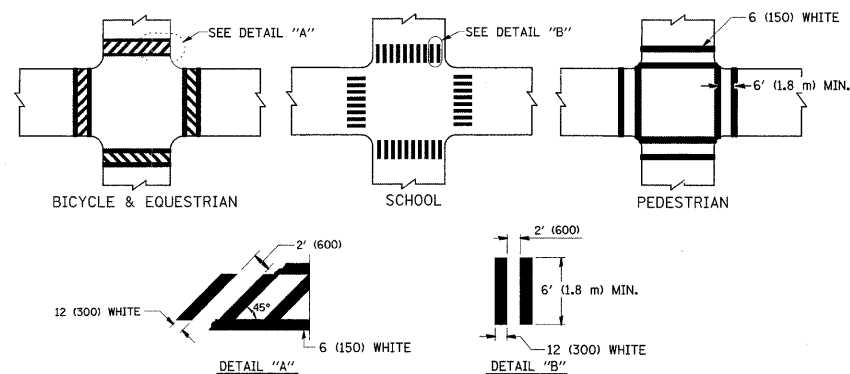

TYPICAL CROSSWALK MARKING

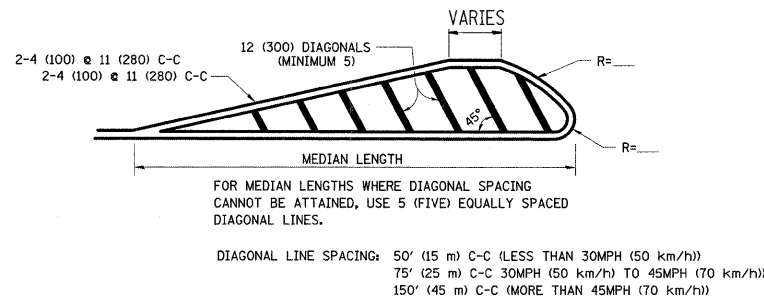

MEDIANS OVER 4' (1.2 m) WIDE

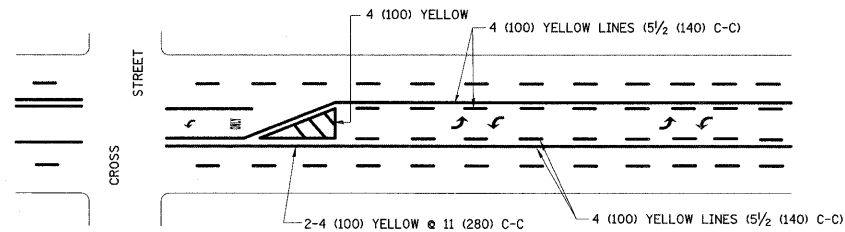

A MINIMUM OF TWO PAIRS OF TURN ARROWS SHALL BE USED, WHITE IN COLOR. ADDITIONAL PAIRS SHALL BE PLACED AT 200' (60 m) TO 300' (90 m) INTERVALS.

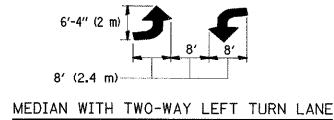

TYPICAL PAINTED MEDIAN MARKING

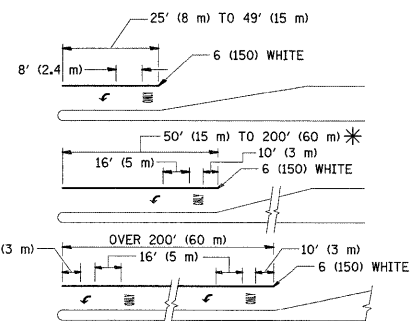

FULL SIZE LETTERS 8' (2.4 m) AND ARROWS SHALL BE USED.
* AREA = 15.6 SQ. FT. (1.5 m²) □ AREA = 20.8 SQ. FT. (1.9 m²)

* TURN LANES IN EXCESS OF 400' (120 m) IN LENGTH MAY HAVE AN ADDITIONAL SET OF ARROW - "ONLY" INSTALLED MIDWAY BETWEEN THE OTHER TWO SETS OF ARROW - "ONLY".

TYPICAL LEFT (OR RIGHT) TURN LANE

TYPICAL TURN LANE MARKING

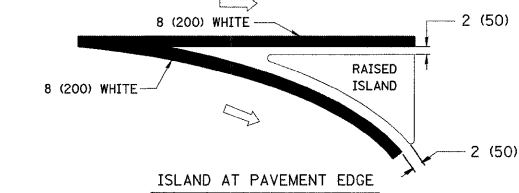
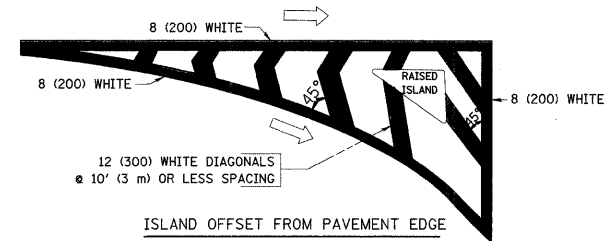

TYPICAL ISLAND MARKING

TYPE OF MARKING	WIDTH OF LINE	PATTERN	COLOR	SPACING / REMARKS
CENTERLINE ON 2 LANE PAVEMENT	4 (100)	SKIP-DASH	YELLOW	10' (3 m) LINE WITH 30' (9 m) SPACE
CENTERLINE ON MULTI-LANE UNDIVIDED PAVEMENT	2 @ 4 (100)	SOLID	YELLOW	11 (280) C-C
NO PASSING ZONE LINES: FOR ONE DIRECTION FOR BOTH DIRECTIONS	4 (100) 2 @ 4 (100)	SOLID SOLID	YELLOW YELLOW	5/2 (140) C-C FROM SKIP-DASH CENTERLINE 11 (280) C-C OMIT SKIP-DASH CENTERLINE BETWEEN
LANE LINES	4 (100) 5 (125) ON FREEWAYS	SKIP-DASH SKIP-DASH	WHITE WHITE	10' (3 m) LINE WITH 30' (9 m) SPACE
DOTTED LINES (EXTENSIONS OF CENTER, LANE OR TURN LANE MARKINGS)	SAME AS LINE BEING EXTENDED	SKIP-DASH	SAME AS LINE BEING EXTENDED	2' (600) LINE WITH 6' (1.8 m) SPACE
EDGE LINES	4 (100)	SOLID	YELLOW-LEFT WHITE-RIGHT	OUTLINE MOUNTABLE MEDIANS IN YELLOW; EDGE LINES ARE NOT USED NEXT TO BARRIER CURB
TURN LANE MARKINGS	6 (150) LINE; FULL SIZE LETTERS & SYMBOLS (8' (2.4m))	SOLID	WHITE	SEE TYPICAL TURN LANE MARKING DETAIL
TWO WAY LEFT TURN MARKING	2 @ 4 (100) EACH DIRECTION 8' (2.4m) LEFT ARROW	SKIP-DASH AND SOLID IN PAIRS	YELLOW WHITE	10' (3 m) LINE WITH 30' (9 m) SPACE FOR SKIP-DASH 5/2 (140) C-C BETWEEN SOLID LINE AND SKIP-DASH LINE SEE TYPICAL TWO-WAY LEFT TURN MARKING DETAIL
CROSSWALK LINES (PEDESTRIAN) A. DIAGONALS (BIKE & EQUESTRIAN) B. LONGITUDINAL BARS (SCHOOL)	2 @ 6 (150) 12 (300) @ 45° 12 (300) @ 90°	SOLID SOLID SOLID	WHITE WHITE WHITE	NOT LESS THAN 6' (1.8 m) APART 2' (600) APART 2' (600) APART SEE TYPICAL CROSSWALK MARKING DETAILS.
STOP LINES	24 (600)	SOLID	WHITE	PLACE 4' (1.2 m) IN ADVANCE OF AND PARALLEL TO CROSSWALK, IF PRESENT. OTHERWISE, PLACE AT DESIRED STOPPING POINT. PARALLEL TO CROSSROAD CENTERLINE, WHERE POSSIBLE
PAINTED MEDIANS	2 @ 4 (100) WITH 12 (300) DIAGONALS @ 45° NO DIAGONALS USED FOR 4' (1.2 m) WIDE MEDIANS	SOLID	YELLOW: TWO WAY TRAFFIC WHITE: ONE WAY TRAFFIC	11 (280) C-C FOR THE DOUBLE LINE SEE TYPICAL PAINTED MEDIAN MARKING.
GORE MARKING AND CHANNELIZING LINES	8 (200) WITH 12 (300) DIAGONALS @ 45°	SOLID	WHITE	DIAGONALS: 15' (4.5 m) C-C (LESS THAN 30MPH (50 km/h)) 20' (6 m) C-C 30MPH (50 km/h) TO 45MPH (70 km/h) 30' (9 m) C-C (OVER 45MPH (70 km/h))
RAILROAD CROSSING	24 (600) TRANSVERSE LINES; "RR" IS 6' (1.8 m) AREA OF: "R"=3.6 SQ. FT. (0.33 m ²) EACH "X"=54.0 SQ. FT. (5.0 m ²)	SOLID	WHITE	SEE STATE STANDARD 780001
SHOULDER DIAGONALS	12 (300) @ 45°	SOLID	WHITE - RIGHT YELLOW - LEFT	50' (15 m) C-C (LESS THAN 30MPH (50 km/h)) 75' (25 m) C-C (30 MPH (50 km/h) TO 45MPH (70 km/h)) 150' (45 m) C-C (OVER 45MPH (70 km/h))

FOR FURTHER DETAILS ON PAVEMENT MARKING REFER TO STANDARD SPECIFICATIONS FOR ROAD AND BRIDGE CONSTRUCTION AND STATE STANDARD 780001.

All dimensions are in inches (millimeters) unless otherwise shown.

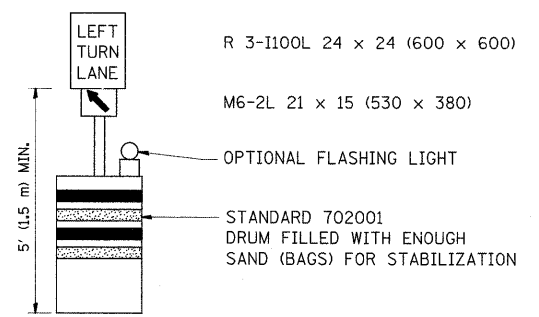
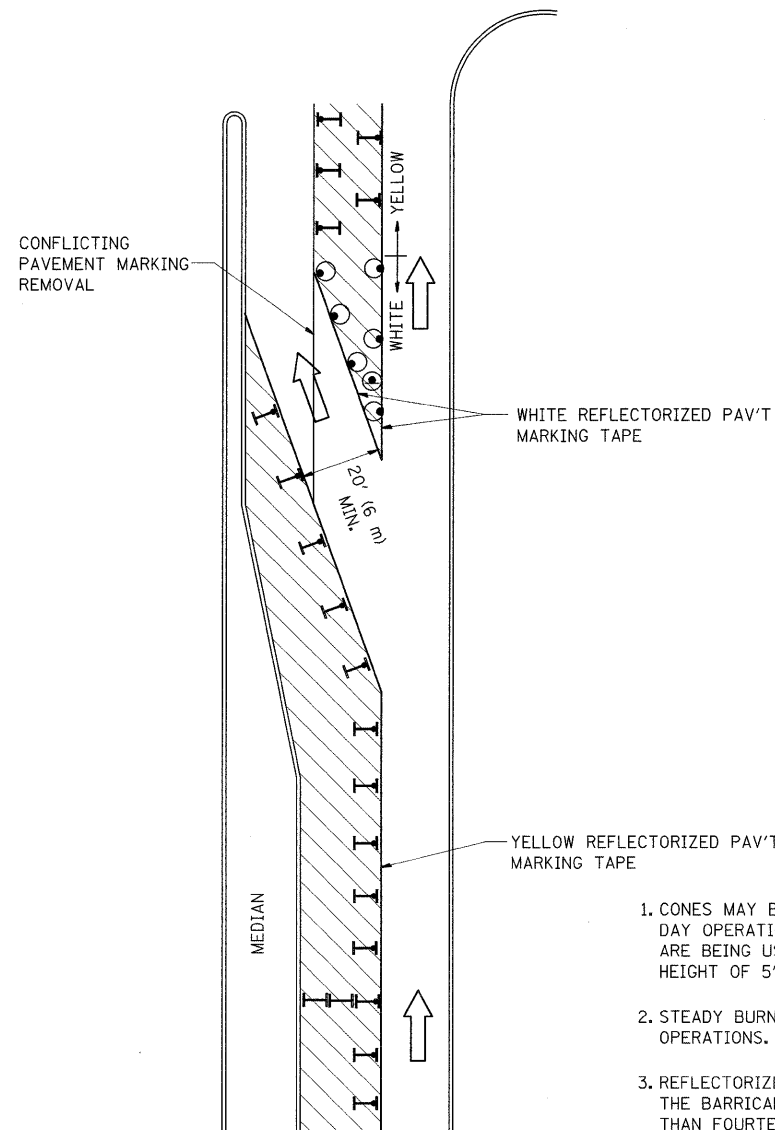







GENERAL NOTES

1. CONES MAY BE SUBSTITUTED FOR BARRICADES OR DRUMS AT HALF THE SPACING DURING DAY OPERATIONS. CONES SHALL BE A MINIMUM OF 28 (710) IN HEIGHT. WHEN CONES ARE BEING USED, THE "LEFT TURN LANE" SIGN MAY BE SKID MOUNTED AT A MINIMUM HEIGHT OF 5' (1.5 m).
2. STEADY BURNING LIGHTS WILL NOT BE REQUIRED ON BARRICADES OR DRUMS FOR DAY OPERATIONS. ALL LIGHTS SHALL BE MONODIRECTIONAL.
3. REFLECTORIZED TEMPORARY PAVEMENT MARKING TAPE SHALL BE PLACED THROUGHOUT THE BARRICADED AREA OF EACH TURN BAY WHERE THE CLOSURE TIME IS GREATER THAN FOURTEEN DAYS.
4. THIS APPLICATION ALSO APPLIES WHEN WORK IS BEING PERFORMED IN THE RIGHT LANE(S) AND THE RIGHT TURN BAY IS TO REMAIN OPEN. UNDER THIS CONDITION, "RIGHT TURN LANE" R3-100 24 x 24 (600 x 600) AND M6-2R 21 x 15 (530 x 380) SHALL BE USED.
5. THESE CONTROLS SHALL SUPPLEMENT MAINLINE TRAFFIC CONTROL FOR LANE CLOSURES.
6. LONGITUDINAL DIMENSIONS MAY BE ADJUSTED TO FIT FIELD CONDITIONS.
7. FORM BT 725 IS REQUIRED.
8. TRAFFIC CONTROL AND PROTECTION AT TURN BAYS (TO REMAIN OPEN TO TRAFFIC) SHALL BE INCLUDED IN THE COST SPECIFIED TRAFFIC CONTROL STANDARDS OR ITEMS.

All dimensions are in inches (millimeters) unless otherwise shown.

LEGEND

-  WORK AREA
-  LANE OPEN TO TRAFFIC
-  TYPE I OR II BARRICADE WITH STEADY BURN LIGHT
-  DRUM WITH STEADY BURN LIGHT
-  DRUM WITH SIGN (WITH OPTIONAL FLASHING LIGHT) SEE DETAIL
-  TYPE I OR II CHECK BARRICADE WITH FLASHING LIGHT

FILE NAME =	USER NAME = ansaris	DESIGNED -	REVISED -T. RAMMACHER 09-08-94
c:\pw_work\pwidot\ansaris\d0137611\DistStd.dgn		DRAWN -	REVISED - A. HOUSEH 11-07-95
		CHECKED -	REVISED - A. HOUSEH 10-12-96
		DATE -	REVISED -T. RAMMACHER 01-06-00

**STATE OF ILLINOIS
DEPARTMENT OF TRANSPORTATION**

**TRAFFIC CONTROL AND PROTECTION AT TURN BAYS
(TO REMAIN OPEN TO TRAFFIC)**

SCALE: NONE SHEET NO. 1 OF 1 SHEETS STA. TO STA.

F.A.J. RTE.	SECTION	COUNTY	TOTAL SHEETS	SHEET NO.
1376	3059A-RS-1	COOK	20	17
TC-14			CONTRACT NO. 60G90	
FED. ROAD DIST. NO. 1 ILLINOIS FED. AID PROJECT				

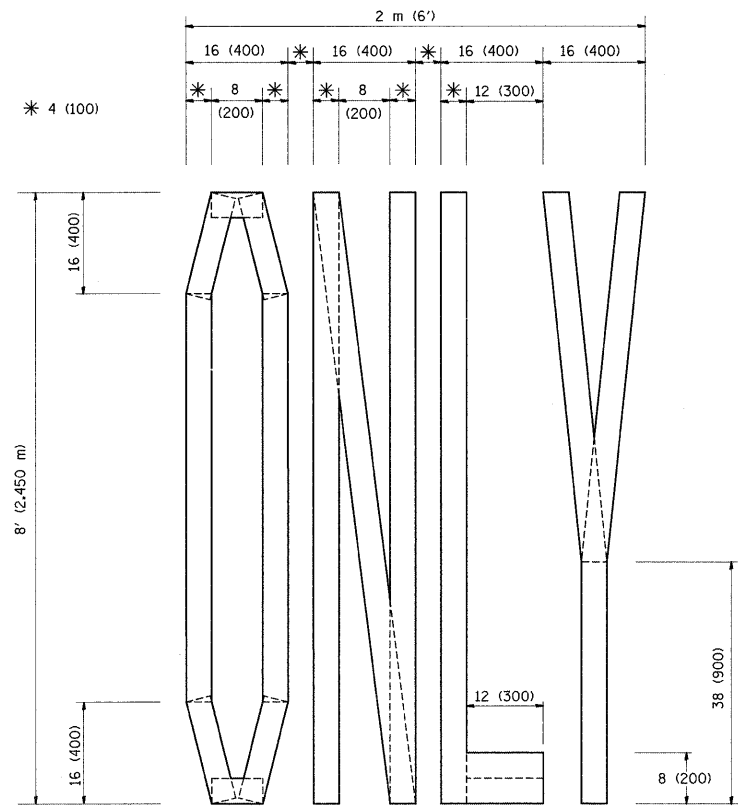

QUANTITY
 4 (100) LINE = 64.1 ft. (19.7 m)
 21.1 sq. ft. (1.97 sq. m)

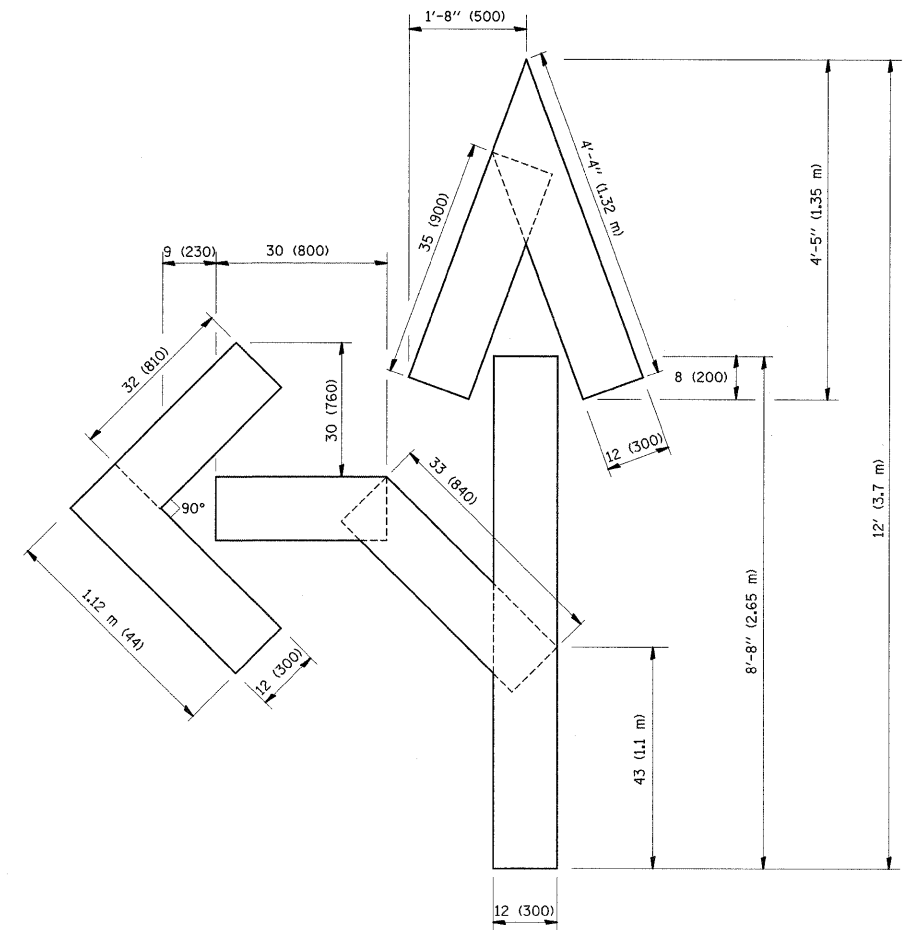

QUANTITY
 4 (100) LINE = 82.5 ft. (25.3 m)
 27.5 sq. ft. (2.53 sq. m)

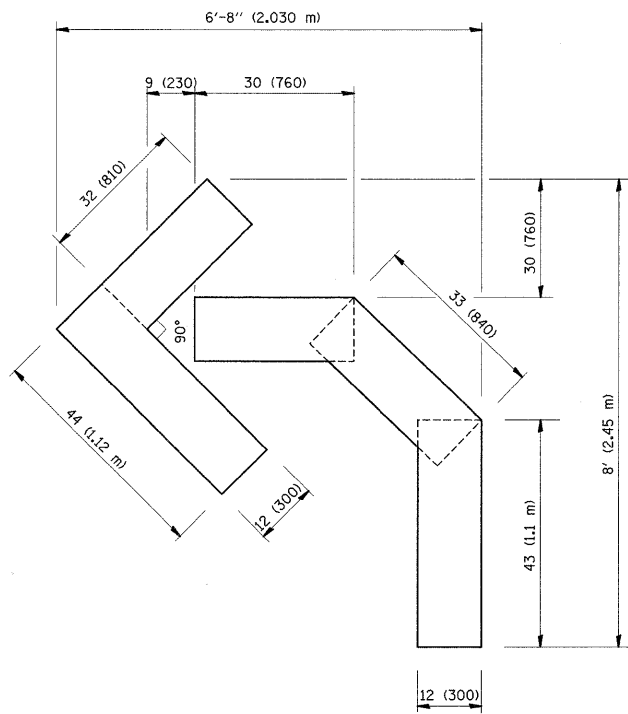

QUANTITY
 4 (100) LINE = 45.5 ft. (13.9 m)
 15.2 sq. ft. (1.39 sq. m)

All dimensions are in inches (millimeters) unless otherwise shown.

FILE NAME =	USER NAME = ansaris	DESIGNED -	REVISED - T. RAMMACHER 06-05-96
ca\pw_work\pwidot\ansaris\0137611\01stSt.dgn		DRAWN -	REVISED - T. RAMMACHER 11-04-97
PLOT SCALE = 50.0000 / / IN.		CHECKED -	REVISED - T. RAMMACHER 03-02-98
PLOT DATE = 4/16/2009		DATE = 09-18-94	REVISED - E. GOMEZ 08-28-00

STATE OF ILLINOIS
 DEPARTMENT OF TRANSPORTATION

PAVEMENT MARKING LETTERS AND SYMBOLS
 FOR TRAFFIC STAGING

SCALE: NONE SHEET NO. 1 OF 1 SHEETS STA. TO STA.

F.A.U. RTE.	SECTION	COUNTY	TOTAL SHEETS	SHEET NO.
1376	3059A-RS-1	COOK	20	18
TC-16			CONTRACT NO. 60G90	
FED. ROAD DIST. NO. 1 ILLINOIS FED. AID PROJECT				

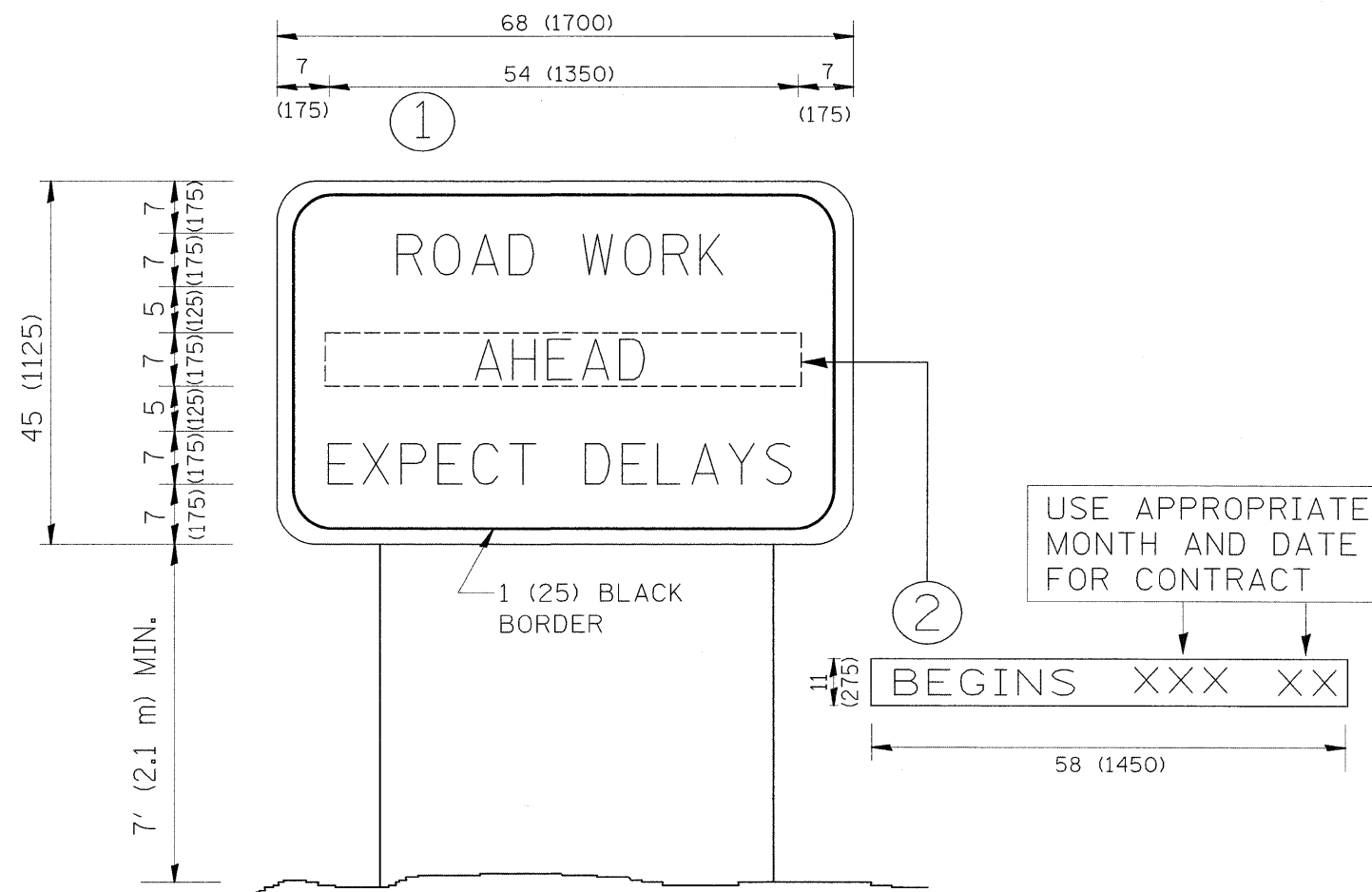

NOTES:

1. USE BLACK LETTERING ON ORANGE BACKGROUND.
2. ERECT SIGNS IN ADVANCE OF THE LOCATION FOR THE "ROAD CONSTRUCTION AHEAD" SIGN AT LOCATIONS AS DIRECTED BY THE ENGINEER.
3. ERECT SIGN ① WITH INSTALLED PANEL ② ONE WEEK PRIOR TO THE START OF CONSTRUCTION.
4. REMOVE PANEL ② SOON AFTER THE START OF CONSTRUCTION.
5. SEE SPECIAL PROVISION FOR "TEMPORARY INFORMATION SIGNING" FOR ADDITIONAL INFORMATION.
6. ONE SIGN ASSEMBLY EQUALS 25.70 SQ. FT. (2.3 SQ. M.)
7. SHALL BE PAID FOR AS TEMPORARY INFORMATION SIGNING.

ALL DIMENSIONS ARE IN INCHES (MILLIMETERS) UNLESS OTHERWISE SHOWN.

FILE NAME =	USER NAME = ansaris	DESIGNED -	REVISED - R. MIRS 09-15-97
cs:\pw_work\pwidot\ansaris\d0137611\DistSd.dgn		DRAWN -	REVISED - R. MIRS 12-11-97
PLOT SCALE = 50.0000 / / IN.		CHECKED -	REVISED - T. RAMMACHER 02-02-99
PLOT DATE = 4/16/2009		DATE -	REVISED - C. JUCIUS 01-31-07

**STATE OF ILLINOIS
DEPARTMENT OF TRANSPORTATION**

**ARTERIAL ROAD
INFORMATION SIGN**

SCALE: NONE SHEET NO. 1 OF 1 SHEETS STA. TO STA.

F.A.J. RTE. 1376	SECTION 3059A-RS-1	COUNTY COOK	TOTAL SHEETS 20	SHEET NO. 19
TC-22			CONTRACT NO. 60G90	
FED. ROAD DIST. NO. 1 ILLINOIS FED. AID PROJECT				

LOOPS NEXT TO SHOULDERS

PROVIDE A PAVEMENT REPLACEMENT
NOTE WHICH SHOULD EQUAL
3' (900 mm) X WIDTH OF
PAVED SHOULDER.

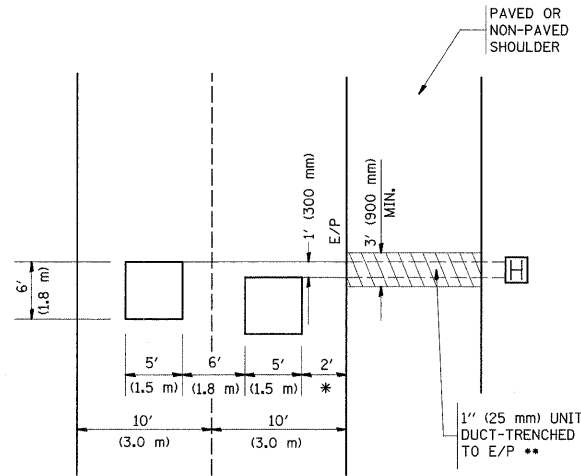

* = (600 mm)

** UNIT DUCT IS TO BE SHOWN ON PLAN SHEETS
BUT SHALL NOT BE INCLUDED IN THE PAY ITEMS.

**LEFT TURN LANES WITH MEDIANS
VOLUME DENSITY ("FAR OUT" DETECTION)
ON SAME APPROACH**

(PROTECTED / PERMITTED LEFT TURN PHASING)

HANDHOLE LOCATION MAY
VARY DEPENDING ON GEOMETRICS
AND DESIGN OF TRAFFIC SIGNALS.
HEAVY-DUTY HANDHOLES TO BE
USED WHEN THE MEDIAN IS
MOUNTABLE. REFER TO STANDARD
814001 TO ENSURE THAT HANDHOLE
FITS IN MEDIAN.

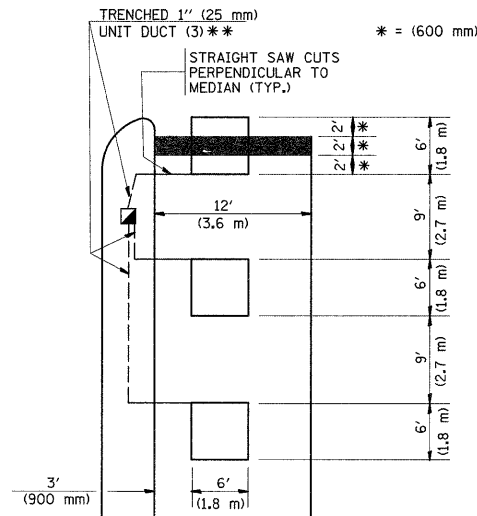

* = (600 mm)

** UNIT DUCT IS TO BE SHOWN ON PLAN SHEETS
BUT SHALL NOT BE INCLUDED IN THE PAY ITEMS.

NOTE: DUAL LEFT TURNS NOT SHOWN REFER TO
PLAN SHEET FOR DETECTOR LOOP REPLACEMENT

**LEFT TURN LANES WITHOUT MEDIANS
VOLUME DENSITY ("FAR OUT" DETECTION)
ON SAME APPROACH**

(PROTECTED / PERMITTED LEFT TURN PHASING)

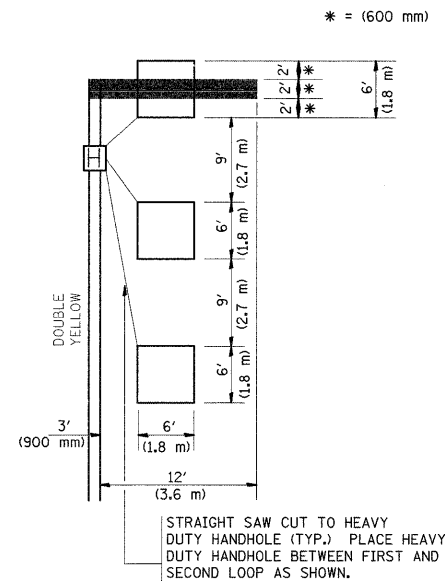

* = (600 mm)

NOTE: DUAL LEFT TURNS NOT SHOWN REFER TO
PLAN SHEET FOR DETECTOR LOOP REPLACEMENT

**ARTERIAL-VOLUME DENSITY ("FAR OUT" DETECTION)
CROSS STREET-VOLUME DENSITY ("FAR OUT" DETECTION)**

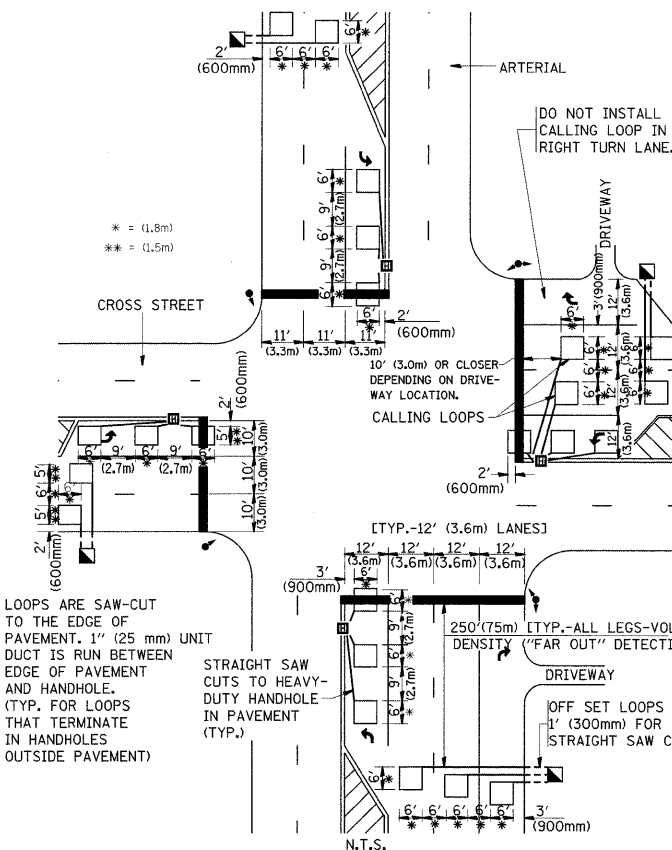

**DETAIL 1
N.T.S.**

**ARTERIAL-VOLUME DENSITY ("FAR OUT" DETECTION)
CROSS STREET-NON VOLUME DENSITY ("UPTIGHT" PRESENCE DETECTION)**

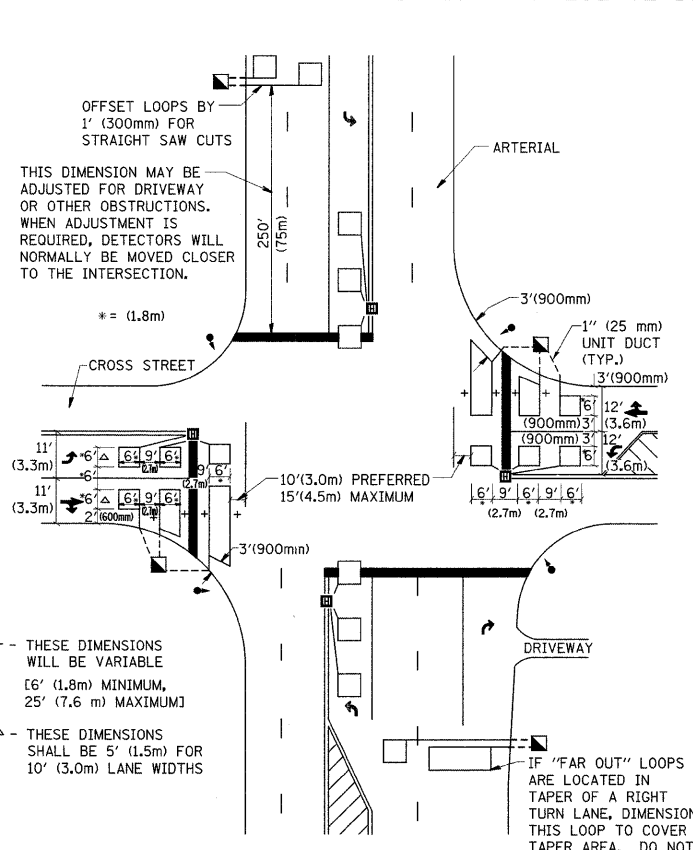

**DETAIL 2
N.T.S.**

NOTES:

VEHICLES LOOP DETECTORS

- * ALL LEAD IN CABLE SHALL BE TWO CONDUCTOR NO. 14 TWISTED, SHIELDED.
- * EACH DETECTOR LOOP SHALL HAVE ITS OWN SAW CUT FROM THE LOOP TO THE EDGE OF PAVEMENT OR TO A HANDHOLE IN THE PAVEMENT.
- * EACH DETECTOR LOOP SHALL HAVE ITS OWN ONE INCH (25 mm) UNIT DUCT BETWEEN THE EDGE OF PAVEMENT AND THE FIRST HANDHOLE OR JUNCTION BOX. EACH UNIT DUCT RUN SHALL BE SHOWN ON THE PLANS BY THE DESIGNER, BUT SHALL NOT BE PAID FOR SEPARATELY. THIS ITEM IS INCIDENTAL TO THE PAY ITEM FOR DETECTOR LOOPS.
- * ONE DIMENSION OF ALL DETECTOR LOOPS SHALL BE SIX FEET (1.8 m)
- * EACH LANE OF NON-LOCKING, PRESENCE DETECTION AND EACH LANE OF A DOUBLE LEFT TURN LANE REQUIRES A SEPARATE INDUCTIVE LOOP DETECTOR AND LEAD IN CABLE.
- * WHEN NON-LOCKING, PRESENCE DETECTION IS USED, MORE THAN ONE LOOP PER LANE IS REQUIRED BEHIND THE STOP BAR (i.e. 1-1/2, 1-3/4, 2).
- * WHEN SYSTEM LOOPS ARE REQUIRED ON AN APPROACH OF AN INTERSECTION, THE LOOPS USED FOR VOLUME DENSITY AND INTERSECTION TIMING SHALL ALSO BE USED AS SYSTEM DETECTORS. EACH ONE OF THESE TYPE OF LOOPS REQUIRES A SEPARATE TWO CONDUCTOR NO. 14 TWISTED SHIELDED CABLE AND A SEPARATE INDUCTIVE LOOP DETECTOR WHEN NEW CONTROLLERS ARE UTILIZED. THE DESIGNER SHALL LABEL THESE TYPES OF LOOPS AS "INTERSECTION AND SAMPLING (SYSTEM) DETECTORS" ON THE SIGNAL LAYOUT, THE INTERCONNECT PLAN AND THE SYSTEM CABLE PLAN. WHEN AN EXISTING CONTROLLER IS UTILIZED FOR THIS TYPE OF DETECTION, THE PAY ITEM "INDUCTIVE LOOP DETECTOR WITH SYSTEM OUTPUT" SHOULD BE USED.

PLACEMENT OF DETECTORS

THE FOLLOWING FIGURES REPRESENT THE MOST COMMON DETECTOR LOOP LOCATIONS AND SIZES. ADJUSTMENTS WILL BE NECESSARY FOR SPECIFIC GEOMETRIC CONSIDERATIONS.

LOCATIONS AND DEMENSIONS OF DETECTOR LOOPS ARE REQUIRED ON ALL SIGNAL LAYOUT PLAN SHEETS.

"FAR OUT" DETECTION REFERS TO LOCKING, PRESENCE TYPE DETECTION LOCATED IN THRU LANES, RIGHT TURN LANES, AND RIGHT TURN LANE TAPER AREAS (IF APPLICABLE), USUALLY 250' (75 m) IN ADVANCE OF STOP BARS. "UPTIGHT" DETECTION REFERS TO NON-LOCKING PRESENCE TYPE DETECTION LOCATED IN ALL LANES AND 10'-15' (3.0 m-4.5 m) BEHIND THE CROSSING STREET'S EDGE OF PAVEMENT EXTENDED.

NOTE:

ALL DETAILS AND NOTES SHOWN ARE FROM THE I.D.O.T. DISTRICT 1 TRAFFIC SIGNAL DESIGN GUIDELINES DATED JANUARY 1995

THIS DRAWING HAS BEEN PREPARED TO ASSIST THE RESIDENT ENGINEER FOR ALL ROADWAY RESURFACING OR S.M.A.R.T. PROJECTS WHERE THE DIMENSIONS ARE NOT SHOWN ON THE PLANS AND THE FINAL LOCATIONS FOR CROSSWALKS OR STOP BARS ARE NOT DETERMINED.

FILE NAME =	USER NAME = ansoris	DESIGNED -	REVISED -	STATE OF ILLINOIS DEPARTMENT OF TRANSPORTATION	DISTRICT 1 - DETECTOR LOOP INSTALLATION DETAILS FOR ROADWAY RESURFACING			F.A.U. RTE.	SECTION	COUNTY	TOTAL SHEETS	SHEET NO.
ct:\pw_work\pwsdot\ansoris\d0137611\01st5.dgn		DRAWN -	REVISED -					1376	3059A-RS-1	COOK	20	20
PLOT SCALE = 50.0000' / IN.		CHECKED - R.K.F.	REVISED -					TS-07				CONTRACT NO. 60G90
PLOT DATE = 4/16/2009		DATE -	REVISED -					SCALE: NONE	SHEET NO. 1 OF 1 SHEETS	STA. TO STA.	FED. ROAD DIST. NO. 1 [ILLINOIS] FED. AID PROJECT	