

F.A.U. RTE.	SECTION	COUNTY	TOTAL SHEETS	SHEET NO.
3726	(112 & 112X) RS-7	LAKE/COOK	19	1
FED. ROAD DIST. NO. 1	ILLINOIS	CONTRACT NO.	60H03	

STATE OF ILLINOIS
DEPARTMENT OF TRANSPORTATION
DIVISION OF HIGHWAYS

**PROPOSED
HIGHWAY PLANS**

F.A.U. 3726 (LAKE-COOK ROAD /SHERIDAN ROAD)
SECTION (112 & 112X) RS-7
GREEN BAY ROAD TO SHERIDAN ROAD (EAST JUNCTION)
RESURFACING (3P)

LAKE /COOK COUNTY
C-91-559-09

FOR INDEX OF SHEETS, SEE SHEET NO. 2

THESE IMPROVEMENTS ARE LOCATED WITHIN
THE VILLAGE OF GLENCOE AND CITY OF HIGHLAND PARK

TRAFFIC DATA

2006 ADT - 6,600
POSTED SPEED LIMIT - 35 MPH

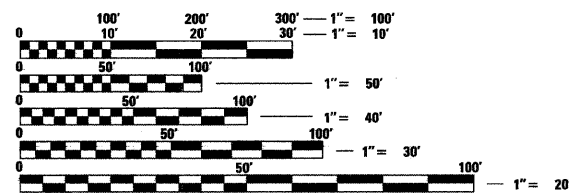

FULL SIZE PLANS HAVE BEEN PREPARED USING STANDARD
ENGINEERING SCALES. REDUCED SIZED PLANS WILL NOT
CONFORM TO STANDARD SCALES. IN MAKING MEASUREMENTS
ON REDUCED PLANS, THE ABOVE SCALES MAY BE USED.

J.U.L.I.E.
JOINT UTILITY LOCATION INFORMATION FOR EXCAVATION
1-800-892-0123
OR 811

Giorba Group, Inc.

DESIGN FIRM
REGISTRATION NUMBER
184-001016

CONSULTING ENGINEERS
SUITE 402, 5507 NORTH CUMBERLAND AVE
CHICAGO, ILLINOIS 60656 ☎ (773) 775-4009

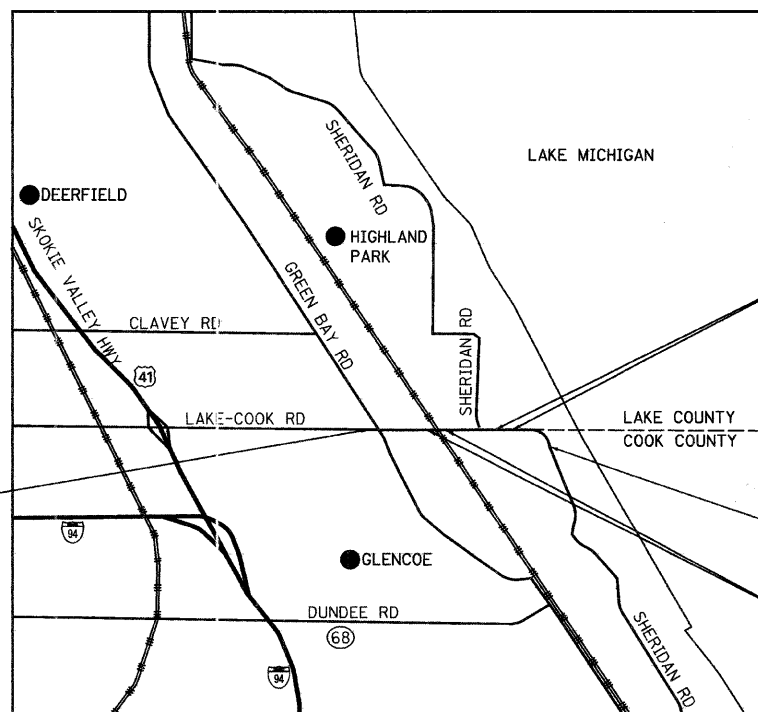

BEGIN PROJECT
STA. 102+96

133+75
OMISSION
135+94

END PROJECT
STA. 148+00

117+74
OMISSION
118+60

GROSS LENGTH OF PROJECT = 4,504 FT = 0.85 MI.
NET LENGTH OF PROJECT = 4,199 FT = 0.80 MI.

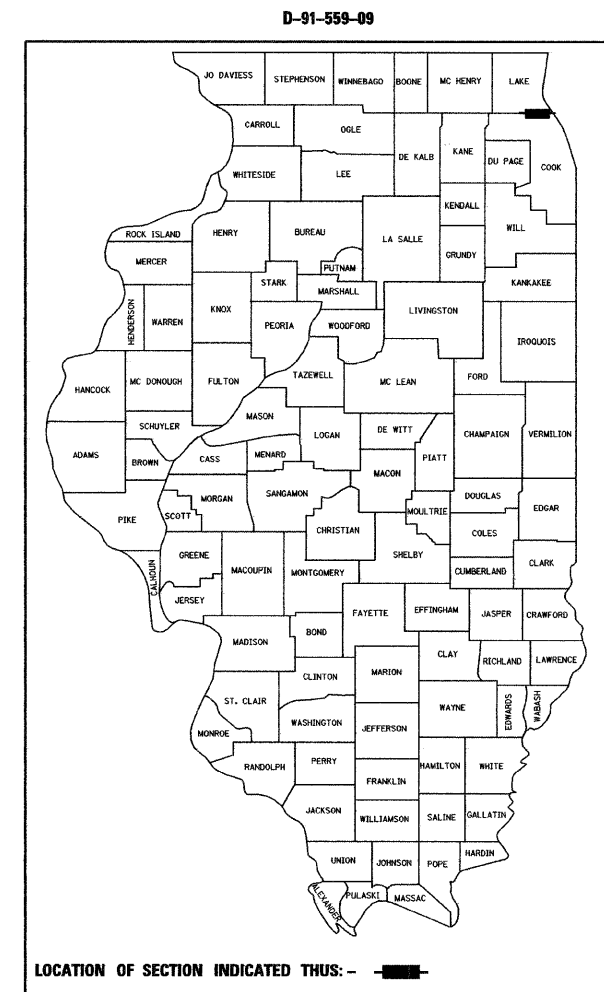

LOCATION OF SECTION INDICATED THUS: - - -

STATE OF ILLINOIS
DEPARTMENT OF TRANSPORTATION
DIVISION OF HIGHWAYS

SUBMITTED APRIL 14, 2009
Diana M. O'Keefe
DEPUTY DIRECTOR OF HIGHWAYS, REGION ENGINEER
May 1, 2009
Charles G. Ingersoll
ENGINEER OF DESIGN AND ENVIRONMENT
May 1, 2009
Christine M. Reed
DIRECTOR OF HIGHWAYS, CHIEF ENGINEER



DATE: 4/13/2009
SEAL EXPIRES: 11/30/2009

**PRINTED BY THE AUTHORITY
OF THE STATE OF ILLINOIS**

DISTRICT 1 DESIGN PLAN PREPARATION ENGINEER: K. ENG (847)705-4247

CONTRACT NO. 60H03

INDEX OF SHEETS

SHEET NO DESCRIPTION

1	COVER SHEET
2	INDEX OF SHEETS, STATE STANDARDS AND GENERAL NOTES
3	SUMMARY OF QUANTITIES
4	TYPICAL SECTIONS
5-6	PROPOSED ROADWAY AND PAVEMENT MARKING PLAN
7-8	DETECTOR LOOP REPLACEMENT PLANS
9	DETAILS FOR FRAMES AND LIDS ADJUSTMENT WITH MILLING (BD-8)
10	PAVEMENT PATCHING FOR HMA SURFACED PAVEMENT (BD-22)
11	CURB AND GUTTER REMOVAL AND REPLACEMENT (BD-24)
12	BUTT JOINT AND HMA TAPER DETAILS (BD-32)
13	TRAFFIC CONTROL AND PROTECTION FOR SIDE ROADS, INTERSECTIONS, AND DRIVEWAYS (TC-10)
14	TYPICAL APPLICATIONS RAISED REFLECTIVE PAVEMENT MARKERS (SNOW PLOW RESISTANT) (TC-11)
15	DISTRICT ONE TYPICAL PAVEMENT MARKINGS (TC-13)
16	TRAFFIC CONTROL AND PROTECTION AT TURN BAYS (TO REMAIN OPEN TO TRAFFIC) (TC-14)
17	PAVEMENT MARKING LETTERS AND SYMBOLS FOR TRAFFIC STAGING (TC-16)
18	ARTERIAL ROAD INFORMATION SIGN (TC-22)
19	DISTRICT 1 DETECTOR LOOP INSTALLATION DETAILS FOR ROADWAY RESURFACING (TS-07)

STATE STANDARDS

000001-05	STANDARD SYMBOLS, ABBREVIATIONS, AND PATTERNS
442201-03	CLASS C AND D PATCHES
482011-03	HMA SHLD. STRIPS/SHLDS. WITH RESURFACING OR WIDENING AND RESURFACING PROJECTS
602401-02	MANHOLE TYPE A
602601-02	PRECAST REINFORCED CONCRETE FLAT SLAB TOP
604001-03	FRAME AND LIDS, TYPE 1
606001-04	CONCRETE CURB TYPE B AND COMBINATION CONCRETE CURB AND GUTTER
701301-03	LANE CLOSURE, 2L, 2W, SHORT TIME OPERATIONS
701311-03	LANE CLOSURE, 2L, 2W, MOVING DAY OPERATIONS-DAY ONLY
701501-05	URBAN LANE CLOSURE, 2L, 2W, UNDIVIDED
701701-06	URBAN LANE CLOSURE, MULTI LANE INTERSECTION
701801-04	LANE CLOSURE MULTILANE 1W, 2W, CROSSWALK OR SIDEWALK CLOSURE
701901-01	TRAFFIC CONTROL DEVICES
780001-02	TYPICAL PAVEMENT MARKINGS
886001-01	DETECTOR LOOP INSTALLATIONS
886006-01	TYPICAL LAYOUTS FOR DETECTION LOOPS

GENERAL NOTES

- BEFORE STARTING ANY EXCAVATION, THE CONTRACTOR SHALL CALL "JULIE" AT 800-892-0123 OR 811 FOR FIELD LOCATIONS OF BURIED ELECTRIC, TELEPHONE, AND GAS FACILITIES. (48 HOUR NOTIFICATION IS REQUIRED)
- 10 FEET (3 METER) TRANSITIONS SHALL BE USED TO MATCH PROPOSED CURB AND GUTTER AND MEDIAN ITEMS OF WORK TO EXISTING CURB AND GUTTER AND MEDIANS IN THE FIELD UNLESS OTHERWISE SHOWN. THE TRANSITIONS SHALL BE PAID FOR AT THE CONTRACT UNIT PRICE FOR THE PROPOSED ITEMS OF WORK SPECIFIED.
- THE CONTRACTOR SHALL COORDINATE CONSTRUCTION ACTIVITIES WITH UTILITY COMPANIES.
- THE CONTRACTOR WILL NOT BE ALLOWED TO SET UP A YARD OR FIELD OFFICE ON STATE PROPERTY WITHOUT WRITTEN PERMISSION FROM THE DEPARTMENT.
- WHEN ARTIFICIAL LIGHTING IS USED IN NIGHT OPERATIONS THE CONTRACTOR SHALL EXERCISE THE UTMOST PRECAUTIONS IN PREVENTING ADVERSE VISIBILITY TO THE MOTORING PUBLIC AND ADJOINING RESIDENTIAL AREAS.
- THE FOLLOWING RATES OF APPLICATION HAVE BEEN ASSUMED IN CALCULATING PLAN QUANTITIES:

BITUMINOUS MATERIALS (PRIME COAT)	0.0004 TONS/SQ YD
HOT-MIX ASPHALT SURFACE COURSE	112 LBS/SQ YD/INCH
POLYMERIZED LEVELING BINDER (MACHINE METHOD)	105 LBS/SQ YD/INCH
- THE ENGINEER SHALL CONTACT THE TRAFFIC CONTROL SUPERVISORS AT (847) 705-4470 A MINIMUM OF 72 HOURS PRIOR TO THE START OF WORK.
- TWO WEEKS PRIOR TO PLACEMENT OF PERMANENT PAVEMENT MARKINGS THE ENGINEER SHALL CONTACT DEBBI HANLON, AREA TRAFFIC FIELD ENGINEER, AT (847) 438-2300.
- WHEN MILLED PAVEMENT IS OPEN TO TRAFFIC THE MAXIMUM GRADE DIFFERENTIAL BETWEEN PASSES OF THE MILLING MACHINE SHALL NOT EXCEED 1 1/2" (40 MM) WHERE THE SPEED LIMIT IS 45 MPH (80 KM/H) OR LESS AND 1" (25 MM) WHERE THE SPEED LIMIT IS GREATER THAN 45 MPH (80 KM/H). WITH WRITTEN APPROVAL FROM THE ENGINEER, A MAXIMUM GRADE DIFFERENTIAL OF 3" (75 MM) MAY BE ALLOWED IF THE EDGE OF THE MILLING IS SLOPED A MINIMUM 3:1 (H:V).
- BUTT JOINTS WILL BE INSTALLED AT THE END OF ALL RESURFACING (WHERE RESURFACING MEETS EXISTING PAVEMENT). IN ACCORDANCE WITH THE "BUTT JOINT AND HMA TAPER DETAILS" SHEET INCLUDED IN THE PLANS, UNLESS OTHERWISE SPECIFIED.
- FOR PAVEMENT MARKING, REFER TO DISTRICT ONE TYPICAL MARKINGS FOR DETAILS SHOWN.
- MATCH EXISTING PAVEMENT MARKINGS AT PROJECT AND OMISSION LIMITS.
- ALL PATCHES OPENED ON A PARTICULAR DAY MUST BE FILLED THAT DAY TO THE TOP OF THE EXISTING PAVEMENT SURFACE.

- IDOT TRAFFIC SIGNAL AND SYSTEM DETECTION LOOPS ARE PRESENT AT GREEN BAY ROAD AND SHERIDAN ROAD. THE CONTRACTOR MUST NOTIFY THE IDOT AREA TRAFFIC SIGNAL MAINTENANCE AND OPERATIONS ENGINEER AT (847) 705-4139 AND THE DEPARTMENT'S ELECTRICAL MAINTENANCE CONTRACTOR PRIOR TO BEGINNING WORK, AT WHICH TIME ARRANGEMENTS WILL BE MADE TO ADJUST THE TRAFFIC CONTROLLER TIMING TO COMPENSATE FOR THE ABSENCE OF DETECTION. REPLACEMENT OF LOOPS DOES NOT REQUIRE MAINTENANCE TRANSFER, BUT DOES REQUIRE NOTIFICATION OF WORK AND INSPECTION. COORDINATION WITH THE DISTRICT IS CONSIDERED INCIDENTAL TO THIS CONTRACT.
- NO OVERNIGHT LANE CLOSURES SHALL BE ALLOWED.
- CONTINGENCY QUANTITIES HAVE BEEN INCLUDED FOR THE FOLLOWING ITEMS TO BE USED AT THE DIRECTION OF THE ENGINEER:

60406000 FRAMES AND LIDS, TYPE 1, OPEN LID - 3 EACH
 60406100 FRAMES AND LIDS, TYPE 1, CLOSED LID - 3 EACH

FILE NAME = N:\PROJ\3386\3386_15\Design\ProposedPlan\3386_15-02-General Notes.dgn



Ciorba Group, Inc.
 CONSULTING ENGINEERS
 5507 North Cumberland Avenue, Suite 402
 Chicago, Illinois 60656
 Tel. 773.775.4009 Fax 773.775.4014

USER NAME = alau	DESIGNED - MBT	REVISED -
	DRAWN - AL	REVISED -
PLOT SCALE = 1:8000' / IN.	CHECKED - WBL	REVISED -
PLOT DATE = 4/19/2009	DATE - 4/16/2009	REVISED -

**STATE OF ILLINOIS
 DEPARTMENT OF TRANSPORTATION**

**LAKE-COOK ROAD /SHERIDAN ROAD
 GREEN BAY ROAD TO SHERIDAN ROAD (EAST JUNCTION)
 INDEX OF SHEETS, STATE STANDARDS & GENERAL NOTES**

SCALE: SHEET NO. 2 OF 19 SHEETS STA. TO STA.

F.A.I. RTE.	SECTION	COUNTY	TOTAL SHEETS	SHEET NO.
3726	(112 & 112X) RS-7	LAKE/COOK	19	2
CONTRACT NO. 60H03				
FED. ROAD DIST. NO. 1 ILLINOIS FED. AID PROJECT				

SUMMARY OF QUANTITIES			URBAN 100% STATE		CONSTRUCTION TYPE CODE	
CODE NO.	DESCRIPTION	UNIT	TOTAL QUANTITY	LAKE COUNTY 1000	COOK COUNTY 1000	
20200100	EARTH EXCAVATION	CU YD	20	10	10	
20201006	GRADING AND SHAPING SHOULDERS	UNIT	18	9	9	
35501316	HOT-MIX ASPHALT BASE COURSE, 8"	SQ YD	20	10	10	
35800200	AGGREGATE BASE REPAIR	TON	30	15	15	
40201000	AGGREGATE FOR TEMPORARY ACCESS	TON	10	5	5	
40600200	BITUMINOUS MATERIALS (PRIME COAT)	TON	6	3	3	
40600300	AGGREGATE (PRIME COAT)	TON	30	15	15	
40600400	MIXTURE FOR CRACKS, JOINTS, AND FLANGEWAYS	TON	2	1	1	
40600535	LEVELING BINDER (HAND METHOD), N70	TON	10	5	5	
40600895	CONSTRUCTING TEST STRIP	EACH	4	2	2	
40600982	HOT-MIX ASPHALT SURFACE REMOVAL - BUTT JOINT	SQ YD	500	250	250	
40600990	TEMPORARY RAMP	SQ YD	720	360	360	
40601005	HOT-MIX ASPHALT REPLACEMENT OVER PATCHES	TON	50	25	25	
40603310	HOT-MIX ASPHALT SURFACE COURSE, MIX "C", N50	TON	2	1	1	
40603340	HOT-MIX ASPHALT SURFACE COURSE, MIX "D", N70	TON	700	350	350	
44000158	HOT-MIX ASPHALT SURFACE REMOVAL, 2 1/4"	SQ YD	14,800	7,400	7,400	
44000200	DRIVEWAY PAVEMENT REMOVAL	SQ YD	20	10	10	
44001700	COMBINATION CONCRETE CURB AND GUTTER REMOVAL AND REPLACEMENT	FOOT	170	85	85	
44002212	HOT-MIX ASPHALT REMOVAL OVER PATCHES, 3"	SQ YD	280	140	140	
44201753	CLASS D PATCHES, TYPE II, 9 INCH	SQ YD	150	75	75	
44201757	CLASS D PATCHES, TYPE III, 9 INCH	SQ YD	150	75	75	
44201759	CLASS D PATCHES, TYPE IV, 9 INCH	SQ YD	160	80	80	
48102100	AGGREGATE WEDGE SHOULDER, TYPE B	TON	90	45	45	
55039700	STORM SEWERS TO BE CLEANED	FOOT	1,300	650	650	
60257900	MANHOLES TO BE RECONSTRUCTED	EACH	1	1	0	
60300305	FRAMES AND LIDS TO BE ADJUSTED	EACH	2	1	1	

• DENOTES SPECIALTY ITEM

SUMMARY OF QUANTITIES			URBAN 100% STATE		CONSTRUCTION TYPE CODE	
CODE NO.	DESCRIPTION	UNIT	TOTAL QUANTITY	LAKE COUNTY 1000	COOK COUNTY 1000	
60300310	FRAMES AND LIDS TO BE ADJUSTED (SPECIAL)	EACH	15	8	7	
60406000	FRAMES AND LIDS, TYPE 1, OPEN LID	EACH	3	2	1	
60406100	FRAMES AND LIDS, TYPE 1, CLOSED LID	EACH	3	2	1	
67000400	ENGINEER'S FIELD OFFICE, TYPE A	CAL MO	4	2	2	
67100100	MOBILIZATION	L SUM	1	0.5	0.5	
70102620	TRAFFIC CONTROL AND PROTECTION, STANDARD 701501	L SUM	1	0.5	0.5	
70102635	TRAFFIC CONTROL AND PROTECTION, STANDARD 701701	L SUM	1	0.5	0.5	
70300100	SHORT-TERM PAVEMENT MARKING	FOOT	2,520	1,260	1,260	
70300210	TEMPORARY PAVEMENT MARKING - LETTERS AND SYMBOLS	SQ FT	300	150	150	
70300220	TEMPORARY PAVEMENT MARKING - LINE 4"	FOOT	20,900	10,450	10,450	
70300240	TEMPORARY PAVEMENT MARKING - LINE 6"	FOOT	1,100	550	550	
70300260	TEMPORARY PAVEMENT MARKING - LINE 12"	FOOT	300	150	150	
70300280	TEMPORARY PAVEMENT MARKING - LINE 24"	FOOT	500	250	250	
70301000	WORK ZONE PAVEMENT MARKING REMOVAL	SQ FT	3,000	1,500	1,500	
• 78000100	THERMOPLASTIC PAVEMENT MARKING - LETTERS AND SYMBOLS	SQ FT	160	80	80	
• 78000200	THERMOPLASTIC PAVEMENT MARKING - LINE 4"	FOOT	12,700	6,350	6,350	
• 78000400	THERMOPLASTIC PAVEMENT MARKING - LINE 6"	FOOT	700	350	350	
• 78000600	THERMOPLASTIC PAVEMENT MARKING - LINE 12"	FOOT	200	100	100	
• 78000650	THERMOPLASTIC PAVEMENT MARKING - LINE 24"	FOOT	300	150	150	
• 78100100	RAISED REFLECTIVE PAVEMENT MARKER	EACH	180	90	90	
78300200	RAISED REFLECTIVE PAVEMENT MARKER REMOVAL	EACH	86	43	43	
• 88600600	DETECTOR LOOP REPLACEMENT	FOOT	700	350	350	
X0322256	TEMPORARY INFORMATION SIGNING	SQ FT	51	26	25	
X4067107	POLYMERIZED LEVELING BINDER (MACHINE METHOD), IL-4.75, N50	TON	420	210	210	
Z0018500	DRAINAGE STRUCTURES TO BE CLEANED	EACH	20	10	10	
Z0048665	RAILROAD PROTECTIVE LIABILITY INSURANCE	L SUM	1	0.5	0.5	

FILE NAME = N:\PROJ\33868\33868_15\Design\ProposedPlan\33868_15-03-Quantities.dgn



Ciorba Group, Inc.
CONSULTING ENGINEERS
5507 North Cumberland Avenue, Suite 402
Chicago, Illinois 60656
Tel. 773.775.4009 Fax 773.775.4014

USER NAME = wlencaester	DESIGNED - MBT	REVISED -
	DRAWN - AL	REVISED -
PLOT SCALE = 1:8000' / IN.	CHECKED - WBL	REVISED -
PLOT DATE = 4/21/2009	DATE - 4/16/2009	REVISED -

**STATE OF ILLINOIS
DEPARTMENT OF TRANSPORTATION**

**LAKE-COOK ROAD /SHERIDAN ROAD
GREEN BAY ROAD TO SHERIDAN ROAD (EAST JUNCTION)
SUMMARY OF QUANTITIES**

SCALE: SHEET NO. 3 OF 19 SHEETS STA. TO STA.

F.A.I. RTE.	SECTION	COUNTY	TOTAL SHEETS	SHEET NO.
3726	(112 & 112X) RS-7	LAKE/COOK	19	3
FED. ROAD DIST. NO. 1 ILLINOIS FED. AID PROJECT			CONTRACT NO. 60H03	

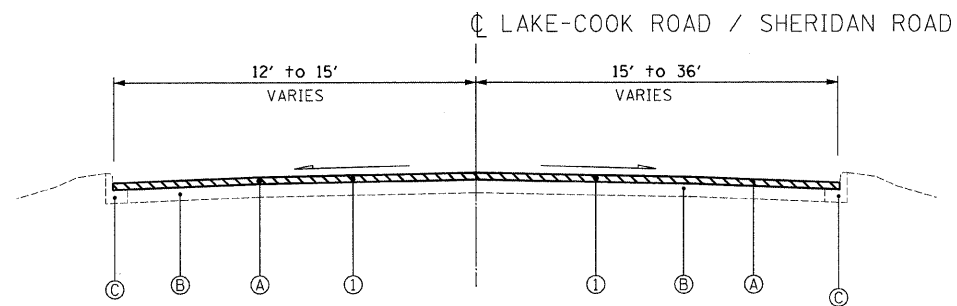

EXISTING TYPICAL SECTION
 STA. 102+96 TO STA. 111+60
 STA. 129+29 TO STA. 133+75
 STA. 135+94 TO STA. 148+00

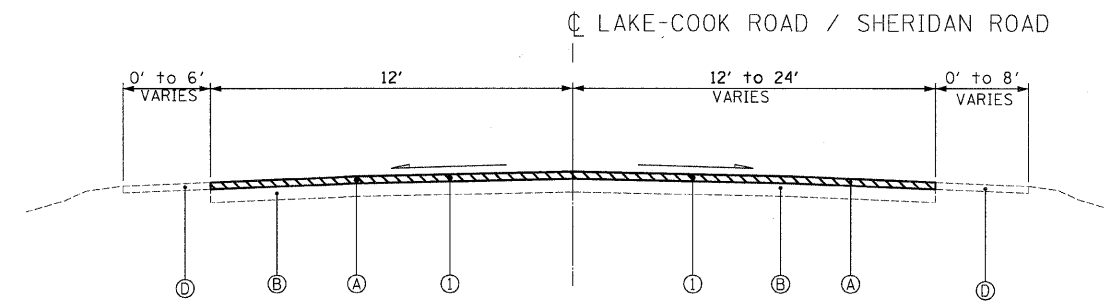

EXISTING TYPICAL SECTION
 STA. 111+60 TO STA. 117+74
 STA. 118+60 TO STA. 129+29

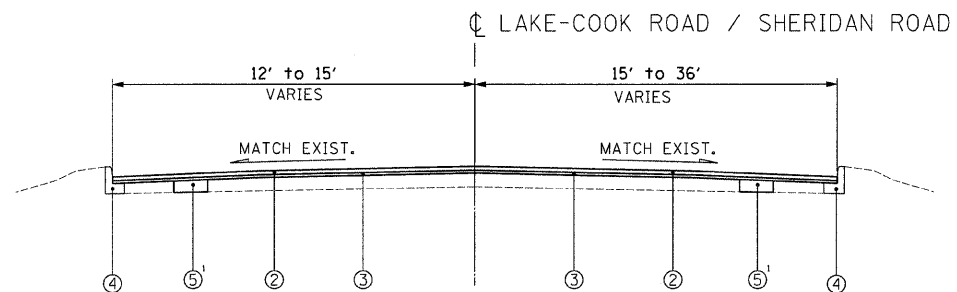

PROPOSED TYPICAL SECTION
 STA. 102+96 TO STA. 111+60
 STA. 129+29 TO STA. 133+75
 STA. 135+94 TO STA. 148+00

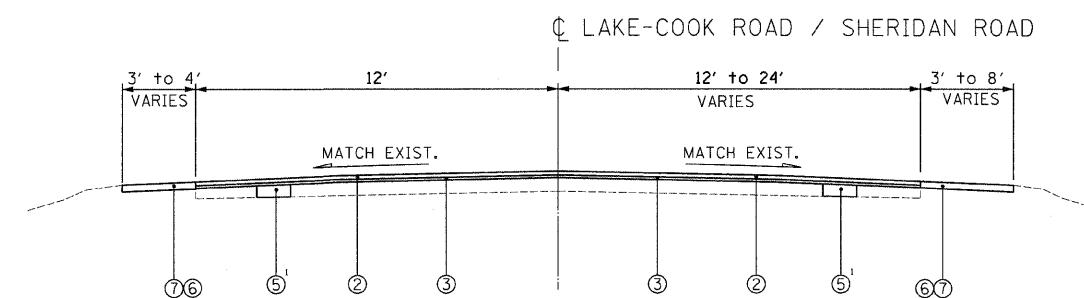

PROPOSED TYPICAL SECTION
 STA. 111+60 TO STA. 117+74
 STA. 118+60 TO STA. 129+29

EXISTING CONDITIONS:

- (A) HOT-MIX ASPHALT SURFACE AND BINDER COURSE, 3" AND VARIES
- (B) PORTLAND CEMENT CONCRETE BASE COURSE, 9"
- (C) COMBINATION CONCRETE CURB AND GUTTER
- (D) AGGREGATE SHOULDER

PROPOSED IMPROVEMENTS:

- (1) HOT-MIX ASPHALT SURFACE REMOVAL, 2 1/4"
- (2) HOT-MIX ASPHALT SURFACE COURSE, MIX "D", N70, 1 1/2"
- (3) POLYMERIZED LEVELING BINDER (MACHINE METHOD), IL-4.75, N50, 3/4"
- (4) COMBINATION CONCRETE CURB AND GUTTER REMOVAL AND REPLACEMENT (AS DIRECTED BY ENGINEER)
- (5) CLASS D PATCHES, 9" (DETERMINED BY ENGINEER IN FIELD)
- (6) AGGREGATE WEDGE SHOULDER, TYPE B
- (7) GRADING AND SHAPING SHOULDERS

A QUANTITY FOR LEVELING BINDER (HAND METHOD) HAS BEEN PROVIDED FOR USE AT ENTRANCES, AROUND HAND HOLES, PRIVATE UTILITY STRUCTURE FRAMES AND ANY OTHER STRUCTURE FRAMES THAT ARE NOT ABLE TO BE LOWERED UNDER THE ITEM "FRAMES AND LIDS TO BE ADJUSTED (SPECIAL)" AFTER GRINDING OF THE EXISTING PAVEMENT.

¹ QUANTITIES FOR EARTH EXCAVATION AND AGGREGATE BASE REPAIR HAVE BEEN INCLUDED FOR SUBGRADE FAILURES BELOW THE CLASS D PATCHES

HOT-MIX ASPHALT MIXTURE REQUIREMENTS CHART

OPERATIONS	MIXTURE TYPE	AC TYPE	PERCENT AIR VOIDS
ROADWAY RESURFACING	HOT-MIX ASPHALT SURFACE COURSE, MIX "D", N70 (IL-9.5MM)	PG 64-22	4% @ 70 GYR
	POLYMERIZED LEVELING BINDER (MACHINE METHOD), IL-4.75, N50	SBS/SBR PG 76-28/-22	4% @ 50 GYR
MAINTENANCE OF TRAFFIC	LEVELING BINDER (HAND METHOD), N70 (IL-9.5MM)	PG 64-22 *	4% @ 70 GYR
PAVEMENT PATCHING	CLASS D PATCHES, 9" (HMA BINDER IL-19 MM)	PG 64-22 *	4% @ 70 GYR
	HOT-MIX ASPHALT REPLACEMENT OVER PATCHES (HMA BINDER IL-19 MM)	PG 64-22 *	4% @ 70 GYR
DRIVES BEHIND CURB	HOT-MIX ASPHALT SURFACE COURSE MIX "C" N50 (IL-9.5MM) 2" THICKNESS	PG 64-22	4% @ 50 GYR
	HOT-MIX ASPHALT BASE COURSE, 8" (HMA BINDER IL-19 MM)	PG 64-22 *	4% @ 50 GYR

THE UNIT WEIGHT USED TO CALCULATE ALL HMA SURFACE MIXTURE QUANTITIES IS 112 LBS/50 YD/IN.

* WHEN RAP EXCEEDS 20%, THE NEW ASPHALT BINDER IN THE MIX SHALL BE PG 58-22.

FILE NAME = m:\proj\33860\33860_15\design\proposed\plan\33860_15-04-Typical Sections.dgn

Ciorba Group, Inc.
 CONSULTING ENGINEERS
 5507 North Cumberland Avenue, Suite 402
 Chicago, Illinois 60656
 Tel. 773.775.4009 Fax 773.775.4014

USER NAME = albu	DESIGNED - MBT	REVISED -
PLOT SCALE = 5,000' / IN.	DRAWN - AL	REVISED -
PLOT DATE = 4/18/2009	CHECKED - WBL	REVISED -
	DATE - 4/16/2009	REVISED -

**STATE OF ILLINOIS
 DEPARTMENT OF TRANSPORTATION**

**LAKE-COOK ROAD /SHERIDAN ROAD
 GREEN BAY ROAD TO SHERIDAN ROAD (EAST JUNCTION)
 TYPICAL SECTIONS**

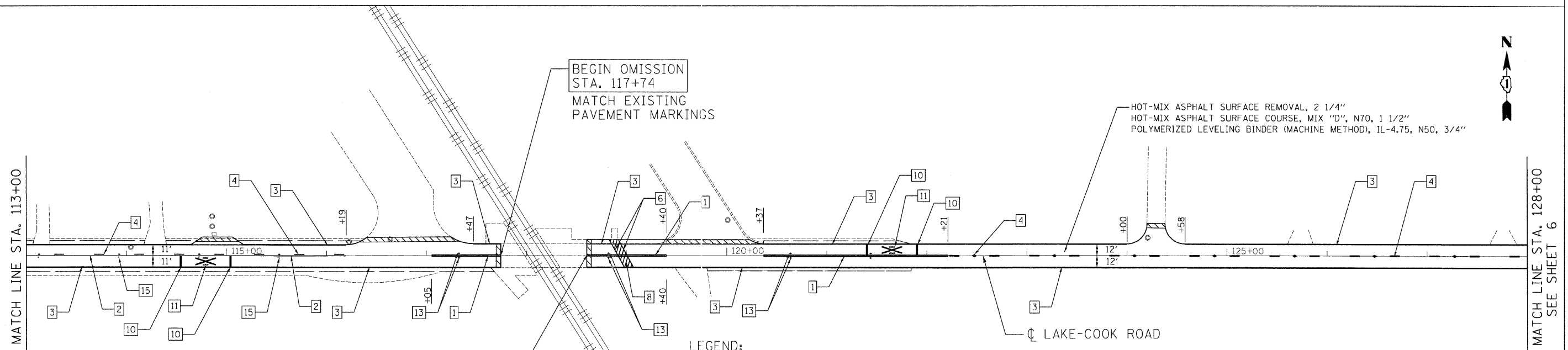
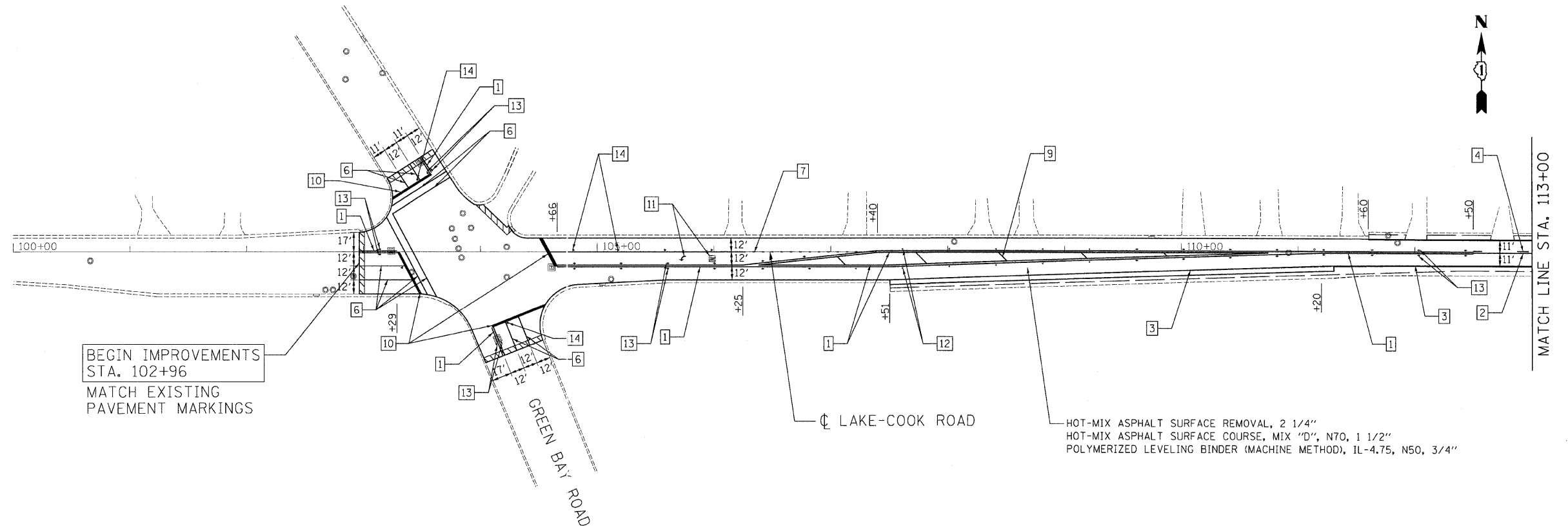

SCALE: N.T.S. SHEET NO. 4 OF 19 SHEETS STA. TO STA.

F.A.U. RTE.	SECTION	COUNTY	TOTAL SHEETS	SHEET NO.
3726	(112 & 112X) RS-7	LAKE/COOK	19	4
CONTRACT NO. 60H03				
FED. ROAD DIST. NO. 1 ILLINOIS FED. AID PROJECT				



LEGEND:

- | | | | |
|---|--|----|---|
| 1 | THERMOPLASTIC PAVEMENT MARKING - LINE 4" (DOUBLE YELLOW SOLID LINE 11" C-C) | 8 | THERMOPLASTIC PAVEMENT MARKING - LINE 12" (WHITE LINE) |
| 2 | THERMOPLASTIC PAVEMENT MARKING - LINE 4" (YELLOW SOLID LINE) | 9 | THERMOPLASTIC PAVEMENT MARKING - LINE 12" (YELLOW DIAGONAL LINE) |
| 3 | THERMOPLASTIC PAVEMENT MARKING - LINE 4" (WHITE SOLID LINE) | 10 | THERMOPLASTIC PAVEMENT MARKING - LINE 24" (WHITE STOP LINE) |
| 4 | THERMOPLASTIC PAVEMENT MARKING - LINE 4" (YELLOW LANE LINE - 10' DASH, 30' SKIP) WITH RAISED REFLECTIVE PAVEMENT MARKERS (TWO-WAY AMBER MARKER) (80' C-C) | 11 | THERMOPLASTIC PAVEMENT MARKING - LETTERS AND SYMBOLS (TYP.) |
| 5 | THERMOPLASTIC PAVEMENT MARKING - LINE 4" (WHITE LANE LINE - 10' DASH, 30' SKIP) WITH RAISED REFLECTIVE PAVEMENT MARKERS (TWO-WAY CRYSTAL MARKER) (80' C-C) | 12 | RAISED REFLECTIVE PAVEMENT MARKERS (ONE-WAY AMBER MARKER) (40' C-C) |
| 6 | THERMOPLASTIC PAVEMENT MARKING - LINE 6" (WHITE SOLID LINE) | 13 | RAISED REFLECTIVE PAVEMENT MARKERS (TWO-WAY AMBER MARKER) (40' C-C) |
| 7 | THERMOPLASTIC PAVEMENT MARKING - LINE 6" (WHITE LANE LINE - 2' DASH, 6' SKIP) | 14 | RAISED REFLECTIVE PAVEMENT MARKERS (ONE-WAY CRYSTAL MARKER) (40' C-C) |
| | | 15 | RAISED REFLECTIVE PAVEMENT MARKERS (ONE-WAY AMBER MARKER) (80' C-C) |

 HOT-MIX ASPHALT SURFACE REMOVAL - BUTT JOINT
 TEMPORARY RAMP

FILE NAME = c:\p\proj\3366\3366.dgn

Ciorba Group, Inc.
 CONSULTING ENGINEERS
 5607 North Cumberland Avenue, Suite 402
 Chicago, Illinois 60656
 Tel. 773.775.4009 Fax 773.775.4014

USER NAME = alou	DESIGNED - MBT	REVISED -
PLOT SCALE = 50,0000' / IN.	DRAWN - AL	REVISED -
PLOT DATE = 4/18/2009	CHECKED - WBL	REVISED -
	DATE - 4/16/2009	REVISED -

**STATE OF ILLINOIS
 DEPARTMENT OF TRANSPORTATION**

**LAKE-COOK ROAD /SHERIDAN ROAD
 GREEN BAY ROAD TO SHERIDAN ROAD (EAST JUNCTION)
 PROPOSED ROADWAY AND PAVEMENT MARKING PLAN**
 SCALE: 1"=50' SHEET NO. 5 OF 19 SHEETS STA. 100+00 TO STA. 128+00

F.A.U. RTE.	SECTION	COUNTY	TOTAL SHEETS	SHEET NO.
3726	(112 & 112X) RS-7	LAKE/COOK	19	5
CONTRACT NO. 60H03			FED. ROAD DIST. NO. 1 ILLINOIS FED. AID PROJECT	

MATCH LINE STA. 128+00
SEE SHEET 6

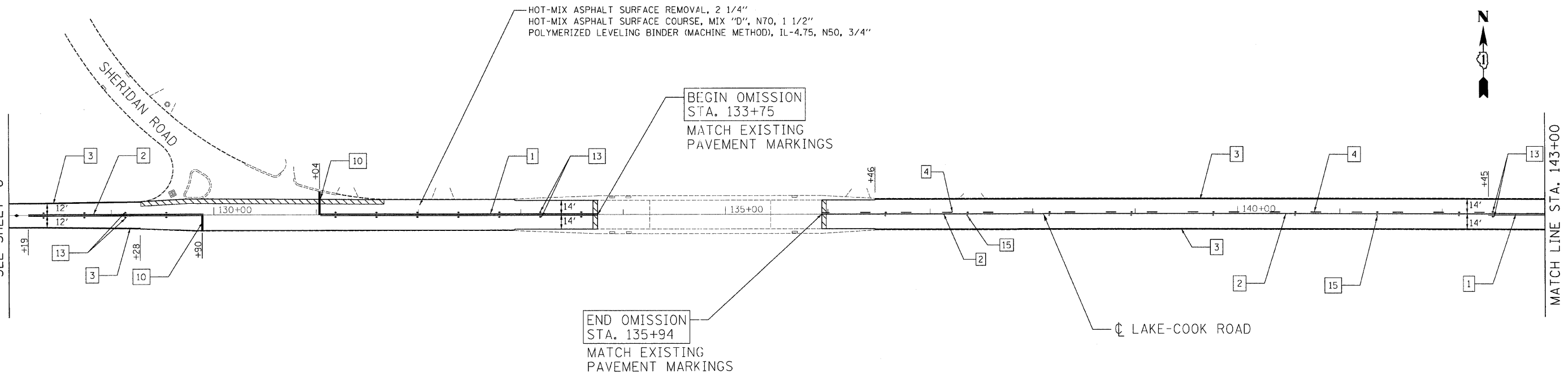

HOT-MIX ASPHALT SURFACE REMOVAL - BUTT JOINT
TEMPORARY RAMP

HOT-MIX ASPHALT SURFACE REMOVAL, 2 1/4"
HOT-MIX ASPHALT SURFACE COURSE, MIX "D", N70, 1 1/2"
POLYMERIZED LEVELING BINDER (MACHINE METHOD), IL-4.75, N50, 3/4"

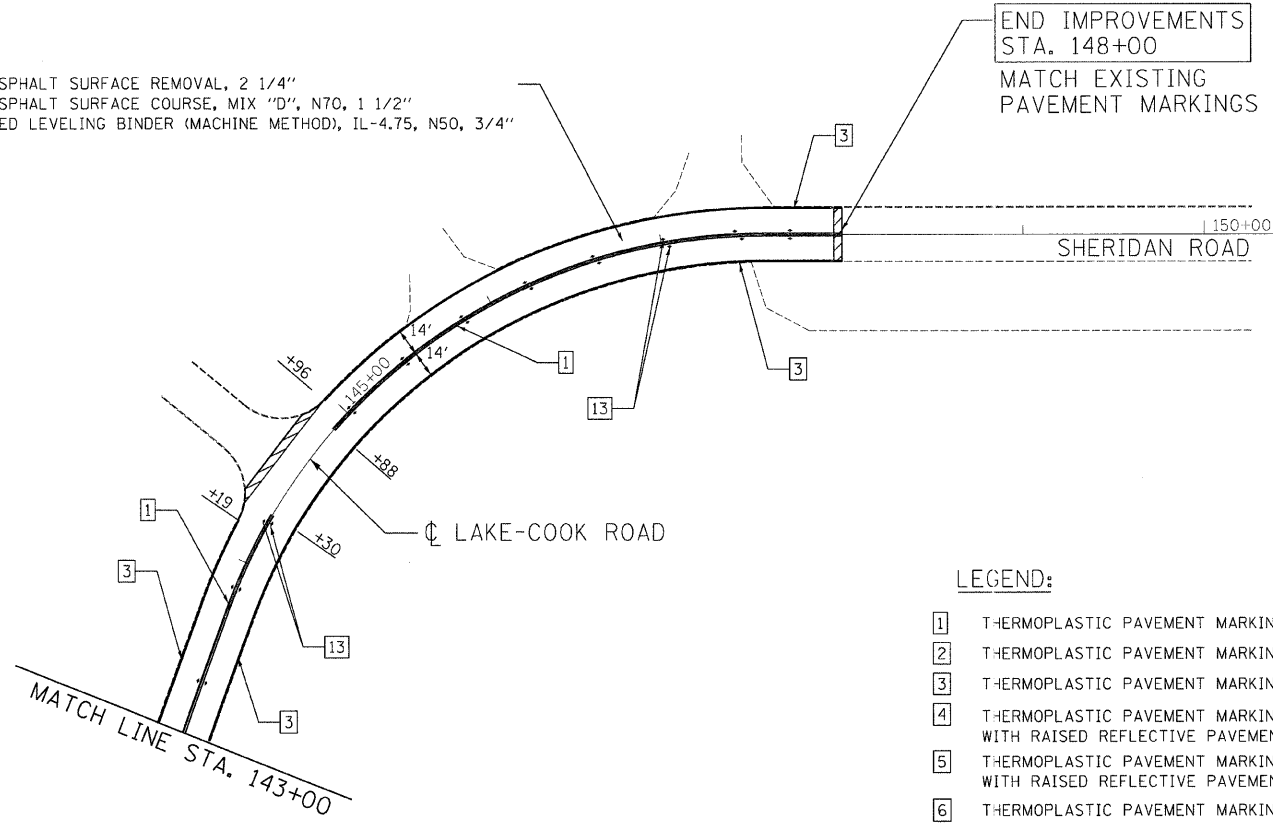

LEGEND:

- | | | | |
|---|--|----|---|
| 1 | THERMOPLASTIC PAVEMENT MARKING - LINE 4" (DOUBLE YELLOW SOLID LINE 11" C-C) | 8 | THERMOPLASTIC PAVEMENT MARKING - LINE 12" (WHITE LINE) |
| 2 | THERMOPLASTIC PAVEMENT MARKING - LINE 4" (YELLOW SOLID LINE) | 9 | THERMOPLASTIC PAVEMENT MARKING - LINE 12" (YELLOW DIAGONAL LINE) |
| 3 | THERMOPLASTIC PAVEMENT MARKING - LINE 4" (WHITE SOLID LINE) | 10 | THERMOPLASTIC PAVEMENT MARKING - LINE 24" (WHITE STOP LINE) |
| 4 | THERMOPLASTIC PAVEMENT MARKING - LINE 4" (YELLOW LANE LINE - 10' DASH, 30' SKIP) WITH RAISED REFLECTIVE PAVEMENT MARKERS (TWO-WAY AMBER MARKER) (80' C-C) | 11 | THERMOPLASTIC PAVEMENT MARKING - LETTERS AND SYMBOLS (TYP.) |
| 5 | THERMOPLASTIC PAVEMENT MARKING - LINE 4" (WHITE LANE LINE - 10' DASH, 30' SKIP) WITH RAISED REFLECTIVE PAVEMENT MARKERS (TWO-WAY CRYSTAL MARKER) (80' C-C) | 12 | RAISED REFLECTIVE PAVEMENT MARKERS (ONE-WAY AMBER MARKER) (40' C-C) |
| 6 | THERMOPLASTIC PAVEMENT MARKING - LINE 6" (WHITE SOLID LINE) | 13 | RAISED REFLECTIVE PAVEMENT MARKERS (TWO-WAY AMBER MARKER) (40' C-C) |
| 7 | THERMOPLASTIC PAVEMENT MARKING - LINE 6" (WHITE LANE LINE - 2' DASH, 6' SKIP) | 14 | RAISED REFLECTIVE PAVEMENT MARKERS (ONE-WAY CRYSTAL MARKER) (40' C-C) |
| | | 15 | RAISED REFLECTIVE PAVEMENT MARKERS (ONE-WAY AMBER MARKER) (80' C-C) |

FILE NAME = n:\proj\3368\3368_15\design\proposals\3368_15-F-Prop82.dgn

Ciorba Group, Inc.
CONSULTING ENGINEERS
5507 North Cumberland Avenue, Suite 402
Chicago, Illinois 60656
Tel. 773.775.4009 Fax 773.775.4014

USER NAME = alou	DESIGNED - MBT	REVISED -
DRAWN - AL	CHECKED - WBL	REVISED -
PLOT SCALE = 50.0000' / IN.	DATE - 4/16/2009	REVISED -
PLOT DATE = 4/18/2009		

**STATE OF ILLINOIS
DEPARTMENT OF TRANSPORTATION**

**LAKE-COOK ROAD /SHERIDAN ROAD
GREEN BAY ROAD TO SHERIDAN ROAD (EAST JUNCTION)
PROPOSED ROADWAY AND PAVEMENT MARKING PLAN**

SCALE: 1"=50' SHEET NO. 6 OF 19 SHEETS STA. 128+00 TO STA. 151+75

F.A.U. RTE.	SECTION	COUNTY	TOTAL SHEETS	SHEET NO.
3726	(112 & 112X) RS-7	LAKE/COOK	19	6
CONTRACT NO. 60H03				
FED. ROAD DIST. NO. 1 ILLINOIS FED. AID PROJECT				

- LEGEND**
- SIGNAL HEAD AND POST
 - SIGNAL HEAD WITH BACKPLATE
 - SIGNAL HEAD, PEDESTRIAN
 - MAST ARM ASSEMBLY AND POLE
 - SIGNAL POST
 - SERVICE INSTALLATION
 - PEDESTRIAN PUSHBUTTON DETECTOR
 - VEHICLE DETECTOR, INDUCTION LOOP TYPE
 - HANDHOLE
 - HEAVY DUTY HANDHOLE
 - DOUBLE HANDHOLE
 - GALVANIZED STEEL CONDUIT
 - CONTROLLER CABINET
- 10'-2"-T IN TRENCH (P = PUSHED)
 SIZE OF CONDUIT
 LENGTH OF CONDUIT

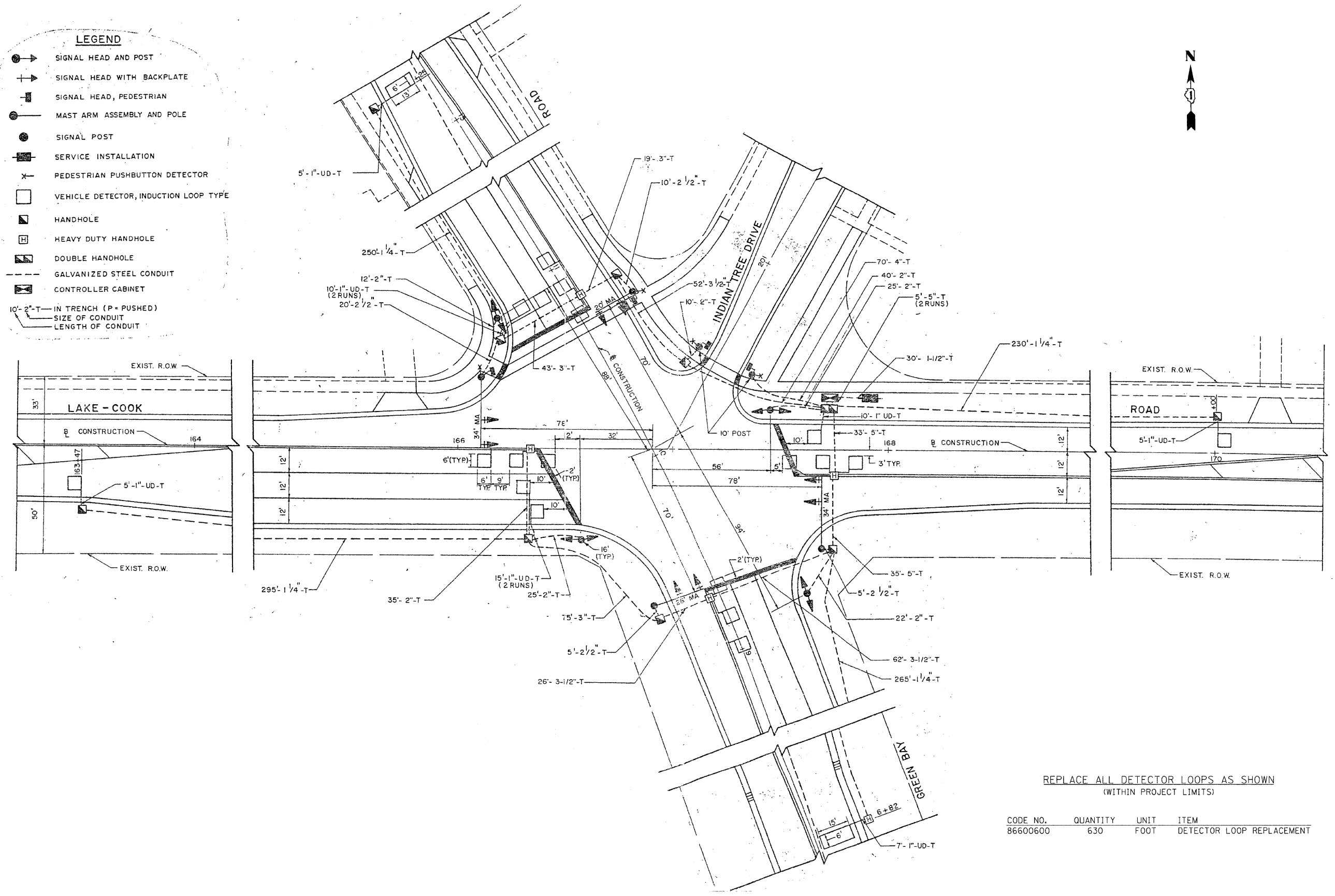

REPLACE ALL DETECTOR LOOPS AS SHOWN
 (WITHIN PROJECT LIMITS)

CODE NO.	QUANTITY	UNIT	ITEM
86600600	630	FOOT	DETECTOR LOOP REPLACEMENT

FILE NAME = rs:\proj\3386\3386_15\design\Signal\3386_15-Loopa21.dgn

Ciorba Group, Inc.
 CONSULTING ENGINEERS
 5507 North Cumberland Avenue, Suite 402
 Chicago, Illinois 60656
 Tel. 773.775.4009 Fax 773.775.4014

USER NAME = alau	DESIGNED - MBT	REVISED -
PLOT SCALE = 1:2000' / IN.	DRAWN - AL	REVISED -
PLOT DATE = 4/16/2009	CHECKED - WBL	REVISED -
	DATE - 4/16/2009	REVISED -

STATE OF ILLINOIS
DEPARTMENT OF TRANSPORTATION

LAKE-COOK ROAD /SHERIDAN ROAD
GREEN BAY ROAD TO SHERIDAN ROAD (EAST JUNCTION)
DETECTOR LOOP REPLACEMENT PLAN

SCALE: N.T.S. SHEET NO. 7 OF 19 SHEETS STA. TO STA.

F.A.U. RTE.	SECTION	COUNTY	TOTAL SHEETS	SHEET NO.
3726	(112 & 112X) RS-7	LAKE/COOK	19	7

CONTRACT NO. 60H03
 FED. ROAD DIST. NO. 1 ILLINOIS FED. AID PROJECT



TRAFFIC SIGNAL LEGEND					
	PROPOSED	EXISTING		PROPOSED	EXISTING
CONTROLLER	⊠	⊠	PEDESTRIAN PUSHBUTTON DETECTOR	⊙	⊙
SERVICE INSTALLATION	⊕	⊕	DETECTOR LOOP	□	□
SIGNAL HEAD	⊖	⊖	CAST IRON JUNCTION BOX	⊙	⊙
SIGNAL HEAD WITH BACKPLATE	⊖	⊖	EMERGENCY VEHICLE SYSTEM DETECTOR	⊖	⊖
SIGNAL HEAD, PEDESTRIAN	⊖	⊖	CONFIRMATION BEACON	⊖	⊖
SIGNAL POST	⊙	⊙	SIGNAL HEAD OPTICALLY PROGRAMMED	⊖	⊖
MAST ARM ASSEMBLY AND POLE, STEEL	⊖	⊖	CONDUIT SPLICE	⊖	⊖
MAST ARM ASSEMBLY AND POLE, ALUMINUM	⊖	⊖	WOOD POLE	⊙	⊙
COMMON TRENCH	CT	CT	RACEWAY FOR MAGNETIC DETECTOR, TYPE I OR TYPE II	⊖	⊖
UNIT DUCT	UD	UD	VEHICLE DETECTOR, NON COMPENSATED MAGNETIC TYPE	⊖	⊖
HANDHOLE	⊖	⊖	RAILROAD CONTROL CABINET	⊖	⊖
HEAVY DUTY HANDHOLE	⊖	⊖	ILLUMINATED SIGN, FIBER OPTIC AND LEFT TURN	⊖	⊖
DOUBLE HANDHOLE	⊖	⊖	ILLUMINATED SIGN, FIBER OPTIC AND RIGHT TURN	⊖	⊖
G.S. CONDUIT IN TRENCH OR PUSHED	---	---	TELEPHONE CONNECTION	⊖	⊖

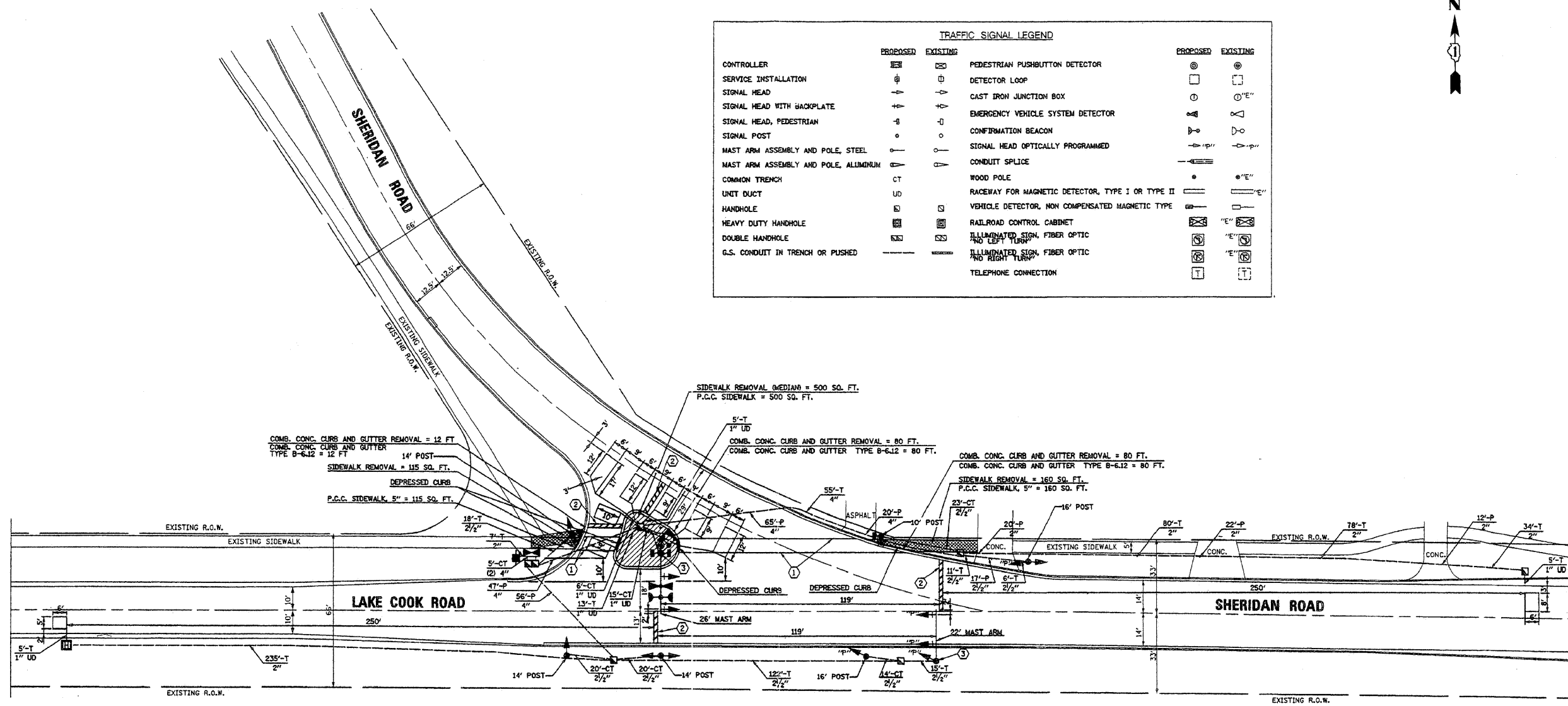

REPLACE ALL DETECTOR LOOPS AS SHOWN
(WITHIN PROJECT LIMITS)

CODE NO.	QUANTITY	UNIT	ITEM
86600600	70	FOOT	DETECTOR LOOP REPLACEMENT

FILE NAME = n:\p\proj\33888\33888_15\design\33888_15\Loopa822.dgn

Ciorba Group, Inc.
CONSULTING ENGINEERS
5507 North Cumberland Avenue, Suite 402
Chicago, Illinois 60656
Tel. 773.775.4009 Fax 773.775.4014

USER NAME	DESIGNED	REVISIONS
elou	MBT	-
	AL	-
	WBL	-
	DATE	4/16/2009

STATE OF ILLINOIS
DEPARTMENT OF TRANSPORTATION

LAKE-COOK ROAD /SHERIDAN ROAD
GREEN BAY ROAD TO SHERIDAN ROAD (EAST JUNCTION)
DETECTOR LOOP REPLACEMENT PLAN

SCALE: N.T.S. SHEET NO. 8 OF 19 SHEETS STA. TO STA.

F.A.U. RTE.	SECTION	COUNTY	TOTAL SHEETS	SHEET NO.
3726	(112 & 112X) RS-7	LAKE/COOK	19	8

CONTRACT NO. 60H03
FED. ROAD DIST. NO. 1 ILLINOIS FED. AID PROJECT

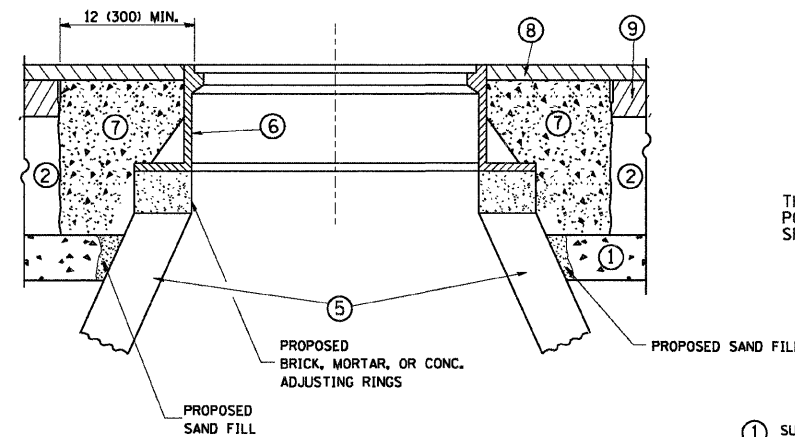
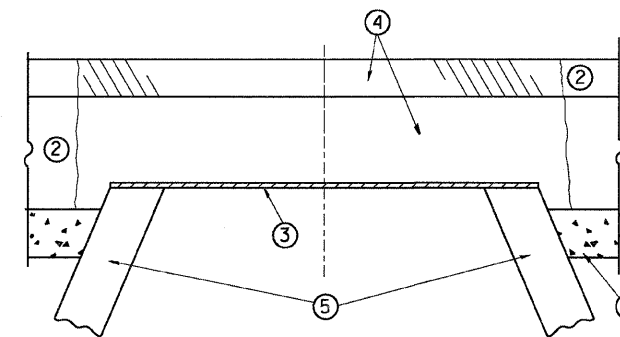

CONSTRUCTION PROCEDURES

STAGE 1 (BEFORE PAVEMENT MILLING)

- A) REMOVE A MINIMUM OF 12 (300) OF THE PAVEMENT FROM AROUND THE STRUCTURE.
- B) REMOVE THE EXISTING FRAME AND LID FROM THE STRUCTURE.
- C) COVER THE STRUCTURE OPENING WITH A 36 (900) DIAMETER METAL PLATE.
- D) BACKFILL WITH CRUSHED STONE AND A MINIMUM 1 1/2 (40) THICK HMA SURFACE MIX APPROVED BY THE ENGINEER.

STAGE 2 (AFTER PAVEMENT MILLING)

- A) REMOVE THE HMA SURFACE MIX AND CRUSHED STONE.
- B) INSTALL THE FRAME AND LID; ADJUST THE FRAME TO ITS FINAL SURFACE ELEVATION.
- C) THE SURROUNDING SPACE SHALL BE FILLED WITH CLASS S1 CONCRETE, OR HMA SURFACE COURSE OR HMA BINDER COURSE TO THE ELEVATION OF THE SURFACE OF THE EXISTING BASE COURSE OR THE BINDER COURSE.

THE PROCEDURE EXPLAINED ABOVE SHALL CONFORM TO THE APPLICABLE PORTIONS OF SECTIONS 353, 406, 602, AND 603 OF THE STANDARD SPECIFICATIONS.

LEGEND

- ① SUB-BASE GRANULAR MATERIAL
- ② EXISTING PAVEMENT
- ③ 36 (900) DIAMETER METAL PLATE
- ④ PROPOSED CRUSHED STONE AND HMA SURFACE MIX
- ⑤ EXISTING STRUCTURE
- ⑥ FRAME AND LID (SEE NOTES)
- ⑦ CLASS S1 CONCRETE, HMA SURFACE COURSE OR HMA BINDER COURSE
- ⑧ PROPOSED CRUSHED STONE AND HMA SURFACE MIX
- ⑨ PROPOSED HMA BINDER COURSE

NOTES:

EXISTING BROKEN FRAMES AND LIDS SHALL BE REMOVED AND DISPOSED OF BY THE CONTRACTOR AND SHALL BE REPLACED AS DIRECTED BY THE ENGINEER. REPLACEMENT FRAMES AND LIDS WILL BE PAID FOR IN ACCORDANCE WITH ARTICLE 109.04 OF THE STANDARD SPECIFICATIONS UNLESS A SEPARATE PAY ITEM HAS BEEN PROVIDED.

IF THE EXISTING LIDS ARE OPEN, THE FRAME WILL BE ADJUSTED TO THE ELEVATION OF THE MILLED PAVEMENT SURFACE PRIOR TO THE MILLING OPERATION. THE FRAME WILL NOT BE REMOVED AND COVERED BY THE METAL PLATE.

CITY OF CHICAGO CASTINGS ARE THE PROPERTY OF THE CITY AND THE CONTRACTOR SHALL NOTIFY THE CITY FOR REMOVAL AND DISPOSITION OF THE CASTINGS.

THE METAL PLATE USED TO COVER THE STRUCTURE SHALL REMAIN THE PROPERTY OF THE CONTRACTOR.

WHEN STRUCTURES ARE TO BE ADJUSTED OR RECONSTRUCTED, THE LOWERING AND RAISING OF THE FRAMES AND LIDS WILL NOT BE PAID FOR SEPARATELY BUT WILL BE INCLUDED IN THE COST OF THE CORRESPONDING PAY ITEM.

LOCATION OF STRUCTURES:

THE CONTRACTOR WILL BE REQUIRED TO KEEP A RECORD OF THE LOCATIONS OF THE BURIED STRUCTURES ACCORDING TO THE STATION AND DISTANCE LEFT OR RIGHT OF THE CENTERLINE OF PAVEMENT. UPON COMPLETION OF THE WORK, THE CONTRACTOR WILL DELIVER THE RECORD TO THE ENGINEER.

BASIS OF PAYMENT: THIS WORK WILL BE PAID FOR AT THE CONTRACT UNIT PRICE PER EACH FOR "FRAMES AND LIDS TO BE ADJUSTED, SPECIAL"

NEW FRAMES AND LIDS, WHEN SPECIFIED, WILL BE PAID FOR SEPARATELY.

DETAILS FOR FRAMES AND LIDS ADJUSTMENT WITH MILLING

ALL DIMENSIONS ARE IN INCHES (MILLIMETERS) UNLESS OTHERWISE SHOWN

FILE NAME = W:\distatd\22x34\bd08.dgn	USER NAME = geglennob	DESIGNED - R. SHAH	REVISED - R. SHAH 03-10-95	STATE OF ILLINOIS DEPARTMENT OF TRANSPORTATION	DETAILS FOR FRAMES AND LIDS ADJUSTMENT WITH MILLING	F.A.U. RTE.	SECTION	COUNTY	TOTAL SHEETS	SHEET NO.	
		DRAWN -	REVISED - A. ABBAS 03-21-97			3726	(112 & 112X) RS-7	LAKE/COOK	19	9	
	PLOT SCALE = 50,0000' / IN.	CHECKED -	REVISED - R. WIEDEMAN 05-14-04			BD600-03 (BD-8)		CONTRACT NO. 60H03			
	PLOT DATE = 1/4/2008	DATE - 10-25-94	REVISED - R. BORO 01-01-07			SCALE: NONE	SHEET NO. 1 OF 1 SHEETS	STA. TO STA.	FED. ROAD DIST. NO. 1 ILLINOIS FED. AID PROJECT		

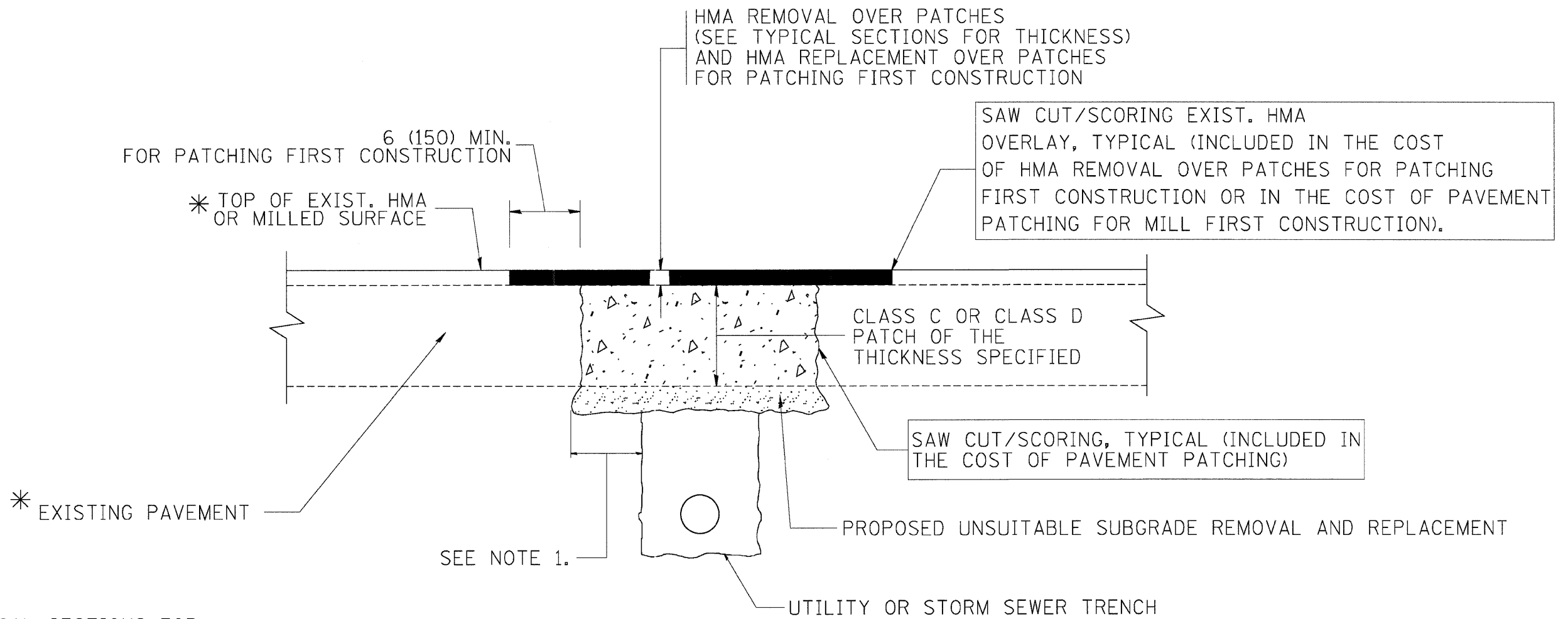

* SEE TYPICAL SECTIONS FOR THICKNESS AND MATERIALS

NOTES:

1. THE WIDTH OF THE FULL DEPTH PATCH OVER A TRENCH SHALL BE 12 (300) WIDER ON EACH SIDE OF THE TRENCH.
2. FOR METHOD OF MEASUREMENT AND BASIS OF PAYMENT, SEE RECURRING SPECIAL PROVISION "PATCHING WITH HOT-MIX ASPHALT OVERLAY REMOVAL".

SEQUENCE OF CONSTRUCTION (PATCHING FIRST)

1. REMOVE THE EXISTING HMA MATERIAL OVER THE AREA TO BE PATCHED.
2. REMOVE AND REPLACE WITH CLASS C OR D PATCH.
3. REPLACE HMA MATERIAL OVER THE AREA TO BE PATCHED.

SEQUENCE OF CONSTRUCTION (MILLING FIRST)

1. MILL HMA FIRST IF THERE IS AT LEAST 4 1/2 INCHES OR MORE OF HMA MATERIAL ON TOP OF THE EXISTING PAVEMENT OR IF THE PAVEMENT IS FULL DEPTH HMA. A MINIMUM OF 2 INCHES OF HMA MATERIAL SHALL BE IN PLACE AFTER MILLING.
2. REMOVE AND REPLACE WITH FULL DEPTH CLASS D PATCHES TO TOP OF MILLED SURFACE.

ALL DIMENSIONS ARE IN INCHES (MILLIMETERS) UNLESS OTHERWISE SHOWN.

FILE NAME = c:\projects\dstsd22x34\bd22.dgn	USER NAME = bauerdi	DESIGNED - R. SHAH	REVISED - A. ABBAS 04-27-98	STATE OF ILLINOIS DEPARTMENT OF TRANSPORTATION	PAVEMENT PATCHING FOR HMA SURFACED PAVEMENT				F.A.J. RTE.	SECTION	COUNTY	TOTAL SHEETS	SHEET NO.
	PLOT SCALE = 50.000' / IN.	DRAWN -	REVISED - R. BORO 01-01-07		3726	(112 & 112X) RS-7	LAKE/COOK	19	10				
	PLOT DATE = 10/27/2008	CHECKED -	REVISED - R. BORO 09-04-07		BD400-04 (BD-22)				CONTRACT NO. 60H03				
		DATE - 10-25-94	REVISED - K. ENG 10-27-08		SCALE: NONE	SHEET NO. 1 OF 1 SHEETS	STA. TO STA.	FED. ROAD DIST. NO. 1 ILLINOIS FED. AID PROJECT					

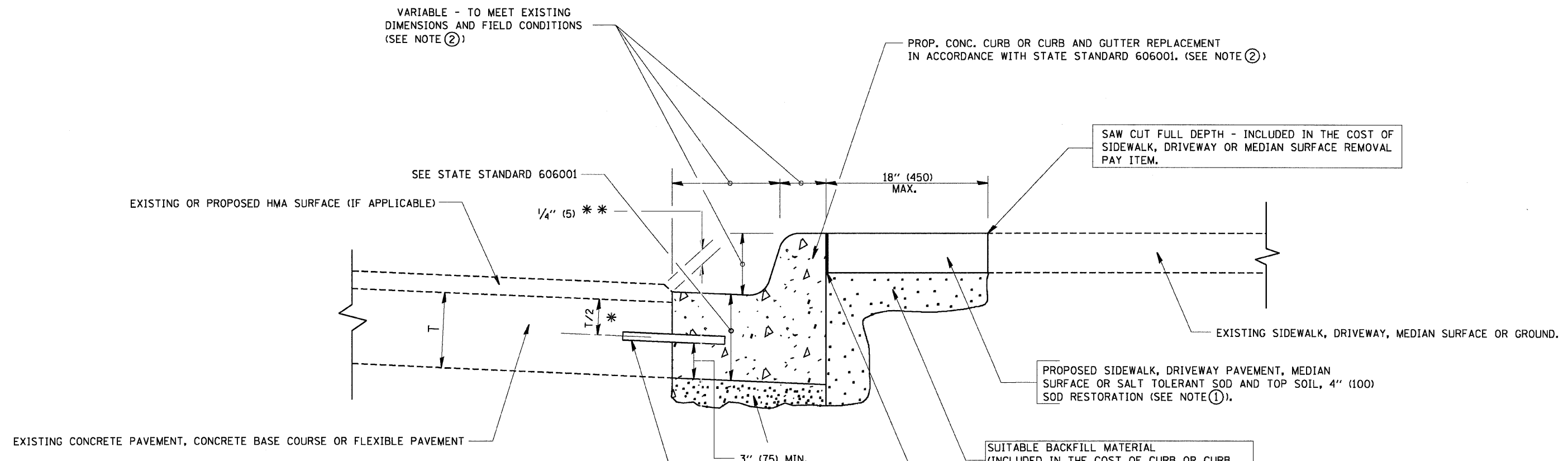

- * 3" (75) MINIMUM FROM TOP AND BOTTOM OF THE CONCRETE PAVEMENT OR BASE COURSE.
- * * IF THE FINAL SURFACE OF THE PAVEMENT IS CONCRETE, THE GUTTER IS TO BE FLUSH WITH THE PAVEMENT.

NOTE: ① SIDEWALK, DRIVEWAY PAVEMENT OR MEDIAN SURFACE SHALL BE SIMILAR TO THE MATERIAL BEING REMOVED AND WILL BE PAID FOR SEPARATELY.

SALT TOLERANT SOD AND TOP SOIL, 4" (100) RESTORATION WILL NOT BE PAID FOR SEPARATELY, BUT SHALL BE INCLUDED IN THE COST OF CURB OR CURB AND GUTTER REMOVAL AND REPLACEMENT.

- ② CURB OR CURB AND GUTTER REPLACEMENT SHALL MATCH THE SHAPE OF THE EXISTING CURB OR CURB AND GUTTER UNLESS OTHERWISE SPECIFIED.
- ③ FOR CURB OR CURB AND GUTTER REMOVAL AND REPLACEMENT ADJACENT TO FLEXIBLE PAVEMENT DELETE EPOXY COATED TIE BARS.
- ④ LONGITUDINAL BARS, IF ENCOUNTERED IN THE EXISTING CURB OR CURB AND GUTTER, ARE NOT TO BE REPLACED. CUTTING AND REMOVING LONGITUDINAL BARS SHALL BE INCLUDED IN THE COST OF CURB OR CURB AND GUTTER REMOVAL AND REPLACEMENT.
- ⑤ THE COST OF HMA SURFACE REMOVAL IN THE EXISTING GUTTER FLAG SHALL BE INCLUDED IN THE COST OF THE CURB AND GUTTER REMOVAL AND REPLACEMENT.
- ⑥ THE REMOVAL AND REPLACEMENT OF THE EXISTING CURB OR CURB AND GUTTER SHALL BE DONE IN ACCORDANCE WITH THE APPLICABLE PORTIONS OF SECTION 440 AND 606 OF THE STANDARD SPECIFICATIONS.
- ⑦ THE LOCATIONS OF REMOVAL AND REPLACEMENT OF EXISTING CURB OR CURB AND GUTTER SHALL BE DETERMINED BY THE RESIDENT ENGINEER AT THE TIME OF CONSTRUCTION.

SUITABLE BACKFILL MATERIAL (INCLUDED IN THE COST OF CURB OR CURB AND GUTTER REMOVAL AND REPLACEMENT)

PROPOSED 3/4" (20) PREFORMED EXPANSION JOINT AT CONCRETE SIDEWALKS, DRIVEWAYS, AND MEDIANS. (INCLUDED IN THE COST OF CURB OR CURB AND GUTTER REMOVAL AND REPLACEMENT.)

UNSUITABLE SUB-BASE MATERIAL TO BE REMOVED, IF DIRECTED BY THE ENGINEER, SHALL BE REPLACED WITH EITHER SUB-BASE GRANULAR MATERIAL, TYPE B OR ADDITIONAL THICKNESS OF CONCRETE.

REMOVAL AND REPLACEMENT 4" (100) OR LESS IS INCLUDED IN THE COST OF CURB OR CURB AND GUTTER REMOVAL AND REPLACEMENT.

REMOVAL AND REPLACEMENT IN EXCESS OF 4" (100) WILL BE PAID FOR IN ACCORDANCE WITH ARTICLE 109.04 OF THE STANDARD SPECIFICATIONS.

PROPOSED #6 (20) EPOXY COATED TIE BARS 24" (600) LONG AT 24" (600) CENTERS WILL NOT BE PAID FOR SEPARATELY. DELETE EPOXY COATED TIE BARS IF EXISTING TIE BARS ARE USUABLE AS DETERMINED BY THE ENGINEER. (SEE NOTE ③).

BASIS OF PAYMENT:
THIS WORK WILL BE PAID FOR AT THE CONTRACT UNIT PRICE PER FOOT (METER) FOR "CURB REMOVAL AND REPLACEMENT" OR "COMBINATION CONCRETE CURB AND GUTTER REMOVAL AND REPLACEMENT".

CURB OR CURB AND GUTTER REMOVAL AND REPLACEMENT

ALL DIMENSIONS ARE IN INCHES (MILLIMETERS) UNLESS OTHERWISE SHOWN.

FILE NAME = W:\distrs\td\22x34\bd24.dgn	USER NAME = goglienobt	DESIGNED - A. HOUSEH	REVISED - R. SHAH 10-03-96	STATE OF ILLINOIS DEPARTMENT OF TRANSPORTATION	CURB OR CURB AND GUTTER REMOVAL AND REPLACEMENT	F.A.U. RTE. 3726	SECTION (112 & 112X) RS-7	COUNTY LAKE/COOK	TOTAL SHEETS 19	SHEET NO. 11
	PLOT SCALE = 50,000 "/ IN.	DRAWN -	REVISED - A. ABBAS 03-21-97			BD600-06 (BD-24)		CONTRACT NO. 60H03		
	PLOT DATE = 1/4/2008	CHECKED -	REVISED - M. GOMEZ 01-22-01		SCALE: NONE	SHEET NO. 1 OF 1 SHEETS		STA. TO STA.		FED. ROAD DIST. NO. 1 ILLINOIS FED. AID PROJECT
		DATE - 03-11-94	REVISED - R. BORO 01-01-07							

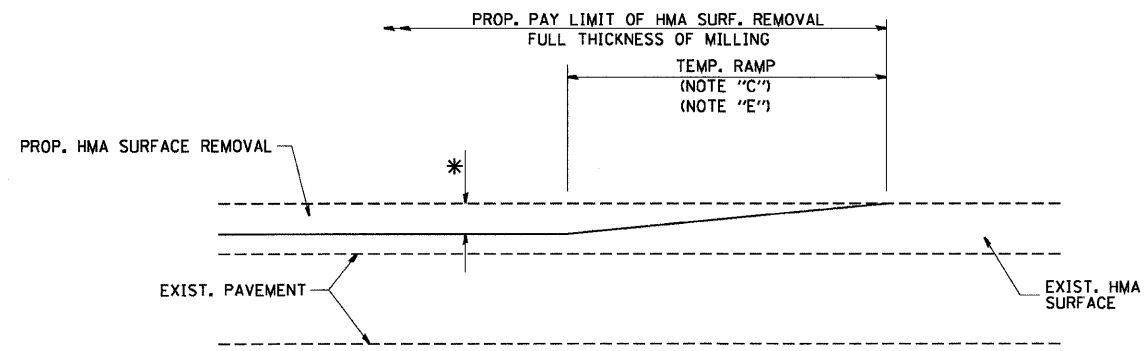

MILLED TEMPORARY RAMP
(FOR BUTT JOINT AND HMA TAPER SEE DETAIL BELOW)

OPTION 1

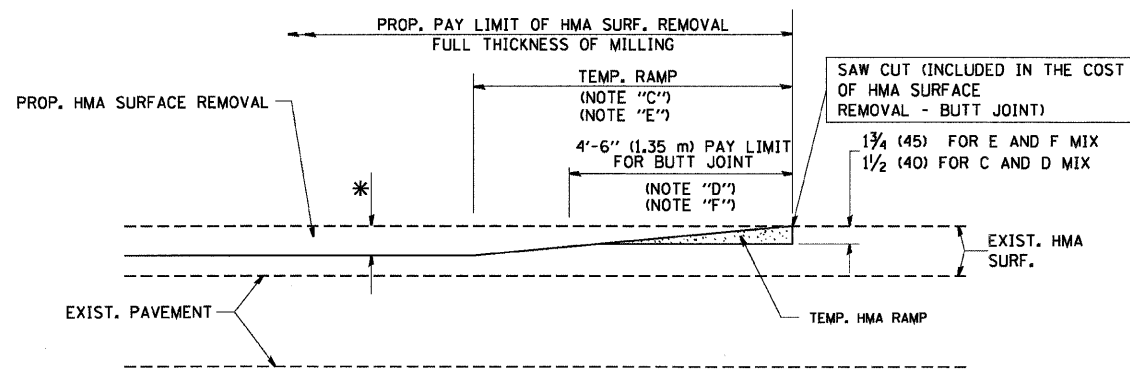

HMA CONSTRUCTED TEMPORARY RAMP
(FOR BUTT JOINT AND HMA TAPER SEE DETAIL BELOW)

OPTION 2

TYPICAL TEMPORARY RAMP

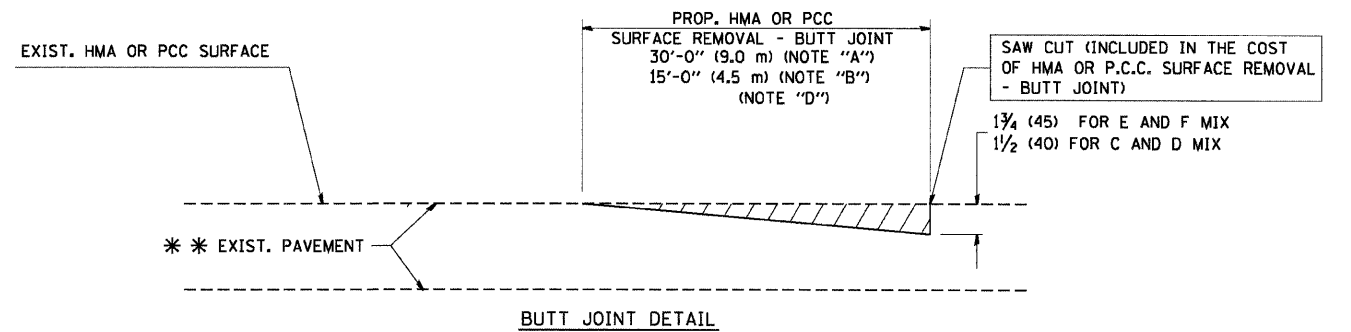

BUTT JOINT DETAIL

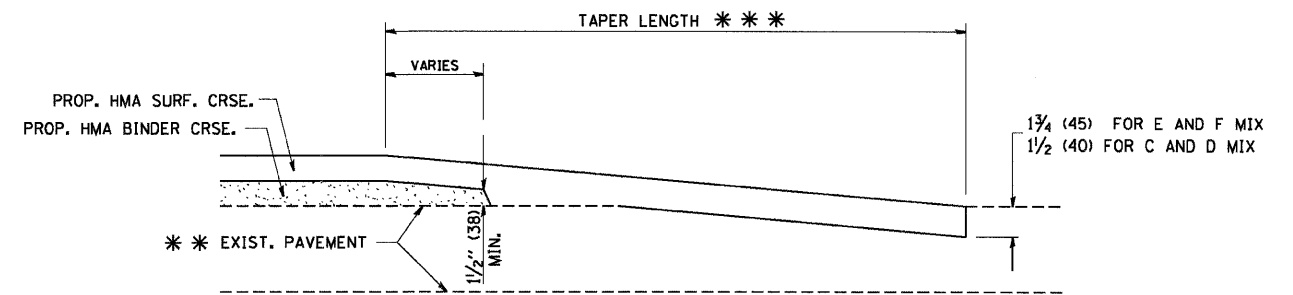

HMA TAPER DETAIL

TYPICAL BUTT JOINT AND HMA TAPER FOR RESURFACING ONLY

* * * PC CONCRETE, HMA OR HMA RESURFACED PAVEMENT.

NOTES

- A: MAINLINE ROADWAYS AND MAJOR SIDE ROADS.
 - B: MINOR SIDE ROADS.
 - C: THE TEMP. RAMP SHALL BE CONSTRUCTED IMMEDIATELY UPON REMOVAL OF THE EXISTING HMA SURFACE.
 - D: THE BUTT JOINT SHALL BE CONSTRUCTED IMMEDIATELY PRIOR TO PLACING THE PROPOSED HMA COURSES.
 - E: TAPER THE TEMP. RAMP AT A RATE OF 3'-0" (900 mm) PER 1 INCH (25 mm) OF MILLING THICKNESS.
 - F: INSTALLATION AND REMOVAL OF THE 4'-6" (1.35 m) TEMP. RAMP IS INCLUDED IN COST OF HMA SURFACE REMOVAL - BUTT JOINT
 - G: SEE ARTICLE 406.08 AND 406.14 OF THE STANDARD SPECIFICATIONS FOR "HMA AND/OR PCC SURFACE REMOVAL, BUTT JOINT".
- * SEE TYPICAL SECTIONS FOR MILLING THICKNESS.

* * * 20'-0" (6.1 m) PER 1 (25) RESURFACING (NOTE "A")
10'-0" (3.0 m) PER 1 (25) RESURFACING (NOTE "B")

BASIS OF PAYMENT:

THE BUTT JOINT WILL BE PAID FOR AT THE CONTRACT UNIT PRICE PER SQUARE YARD (SQUARE METER) FOR "HOT-MIX ASPHALT SURFACE REMOVAL - BUTT JOINT" OR FOR "PORTLAND CEMENT CONCRETE SURFACE REMOVAL - BUTT JOINT".

ALL DIMENSIONS ARE IN INCHES (MILLIMETERS) UNLESS OTHERWISE SHOWN.

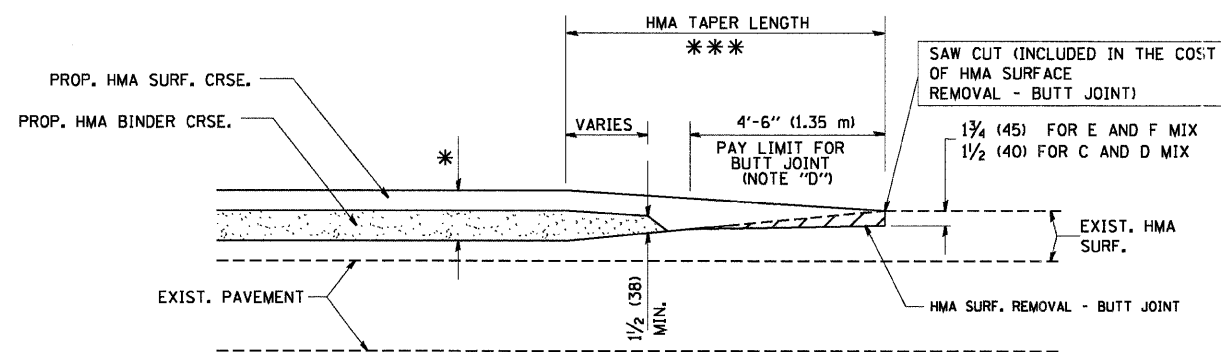

BUTT JOINT AND HMA TAPER

TYPICAL BUTT JOINT AND HMA TAPER FOR MILLING AND RESURFACING

FILE NAME = W:\dists\td\22x34\bd32.dgn	USER NAME = geglienobt	DESIGNED - M. DE YONG	REVISED - R. SHAH 10-25-94
		DRAWN -	REVISED - A. ABBAS 03-21-97
	PLOT SCALE = 50,0000' / IN.	CHECKED -	REVISED - M. GOMEZ 04-06-01
	PLOT DATE = 1/4/2008	DATE - 06-13-90	REVISED - R. BORO 01-01-07

STATE OF ILLINOIS
DEPARTMENT OF TRANSPORTATION

BUTT JOINT AND HMA TAPER DETAILS

SCALE: NONE SHEET NO. 1 OF 1 SHEETS STA. TO STA.

F.A.U. RTE.	SECTION	COUNTY	TOTAL SHEETS	SHEET NO.
3726	(112 & 112X) RS-7	LAKE/COOK	19	12
BD400-05 BD32			CONTRACT NO. 60H03	
FED. ROAD DIST. NO. 1 ILLINOIS FED. AID PROJECT				

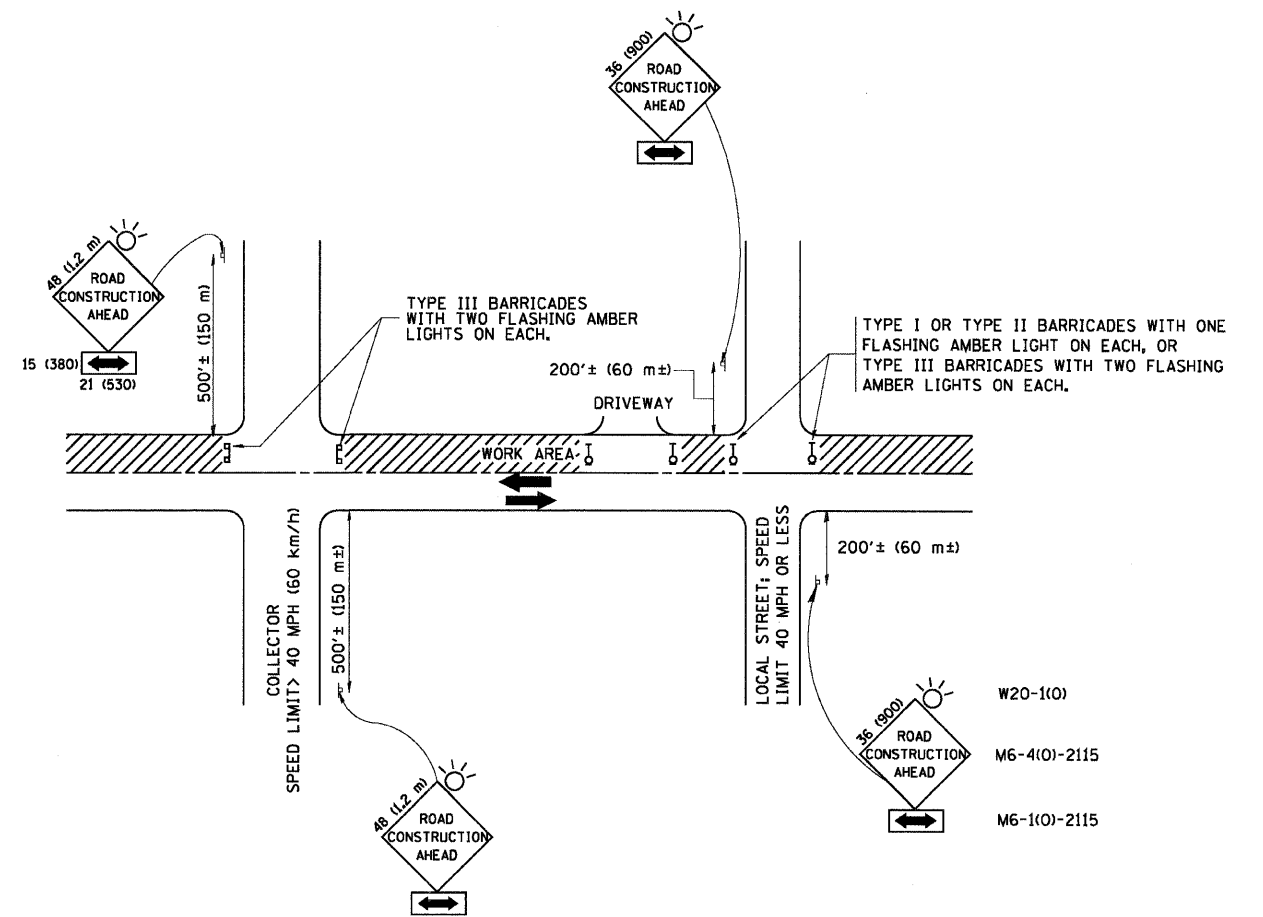

TRAFFIC CONTROL AND PROTECTION FOR SIDE ROADS, INTERSECTIONS, AND DRIVEWAYS

NOTES:

- A. FOR NO LANE RESTRICTION ON THE SIDE ROAD OR DRIVEWAYS
 - 1. SIDE ROAD WITH A SPEED LIMIT OF 40 MPH (60 km/h) OR LESS AS SHOWN ON THE DRAWING AND AS DIRECTED BY THE ENGINEER:
 - a) ONE ROAD CONSTRUCTION AHEAD SIGN 36 x 36 (900x900) WITH A FLASHER AND FLAG MOUNTED ON IT APPROXIMATELY 200' (60 m) IN ADVANCE OF THE MAIN ROUTE.
 - b) THE CLOSED PORTION OF THE MAIN ROUTE SHALL BE PROTECTED BY BLOCKING WITH TYPE I, TYPE II OR TYPE III BARRICADES, 1/3 OF THE CROSS SECTION OF THE CLOSED PORTION.
 - 2. SIDE ROAD WITH A SPEED LIMIT GREATER THAN 40 MPH (60 km/h) AS SHOWN ON THE DRAWING AND AS DIRECTED BY THE ENGINEER:
 - a) ONE ROAD CONSTRUCTION AHEAD SIGN 48 x 48 (1.2 m x 1.2 m) WITH A FLASHER MOUNTED ON IT APPROXIMATELY 500' (150 m) IN ADVANCE OF THE MAIN ROUTE.
 - b) THE CLOSED PORTION OF THE MAIN ROUTE SHALL BE PROTECTED BY BLOCKING WITH TYPE III BARRICADES, 1/2 OF THE CROSS SECTION OF THE CLOSED PORTION.
- 3. WHEN THE SIDE ROAD LIES BETWEEN THE BEGINNING OF THE MAINLINE SIGNING AND THE WORK ZONE, A SINGLE HEADED ARROW (M6-1) SHALL BE USED IN LIEU OF THE DOUBLE HEADED ARROW (M6-4).
- B. FOR A LANE CLOSURE ON A SIDE ROAD OR DRIVEWAY:
 - USE APPLICABLE PORTIONS OF THE TYPICAL APPLICATION OF TRAFFIC CONTROL DEVICES (STD. 701501, STD. 701606 OR THE APPROPRIATE STANDARD). THE SPACING OF SIGNS AND BARRICADES SHALL BE ADJUSTED FOR FIELD CONDITIONS AS DIRECTED BY THE ENGINEER. THE DIRECTIONAL ARROW SHALL BE COVERED OR REMOVED WHEN NO LONGER CONSISTENT WITH THE SIDE ROAD LANE CLOSURE.
- C. ADVANCE WARNING SIGNS ARE TO BE OMITTED ON DRIVEWAY UNLESS OTHERWISE NOTED.
- D. THE TRAFFIC CONTROL AND PROTECTION FOR SIDE ROADS, INTERSECTIONS, AND DRIVEWAYS SHALL BE INCIDENTAL TO THE COST OF SPECIFIED TRAFFIC CONTROL STANDARDS OR ITEMS.

All dimensions are in millimeters (inches) unless otherwise shown.

FILE NAME = W:\datastd\22x34\to10.dgn	USER NAME = geglienobt	DESIGNED - LHA	REVISED - J. OBERLE 10-18-95
		DRAWN -	REVISED - A. HOUSEH 03-06-96
	PLOT SCALE = 50,000' / IN.	CHECKED -	REVISED - A. HOUSEH 10-15-96
	PLOT DATE = 1/4/2008	DATE - 06-89	REVISED - T. RAMMACHER 01-06-00

STATE OF ILLINOIS
DEPARTMENT OF TRANSPORTATION

TRAFFIC CONTROL AND PROTECTION FOR
SIDE ROADS, INTERSECTIONS, AND DRIVEWAYS

SCALE: NONE SHEET NO. 1 OF 1 SHEETS STA. TO STA.

F.A.U. RTE.	SECTION	COUNTY	TOTAL SHEETS	SHEET NO.
3726	(112 & 112X) RS-7	LAKE/COOK	19	13
TC-10			CONTRACT NO. 60H03	
FED. ROAD DIST. NO. 1 ILLINOIS FED. AID PROJECT				

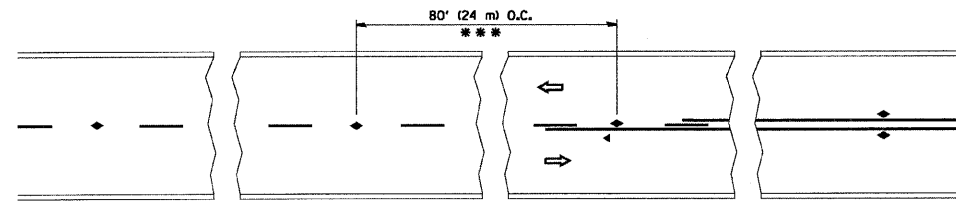

*** REDUCE TO 40' (12 m) O.C. ON CURVES WITH POSTED OR ADVISORY SPEED 45 M.P.H. (70 km/h) OR LESS.

TWO-LANE/TWO-WAY

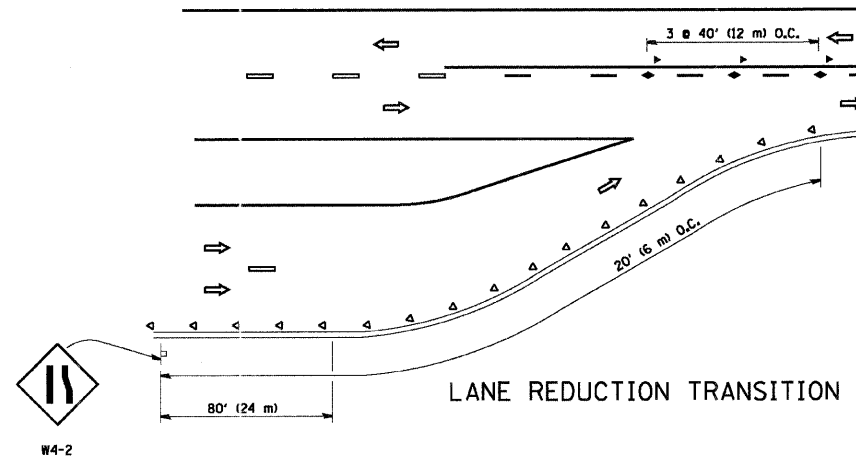

LANE REDUCTION TRANSITION

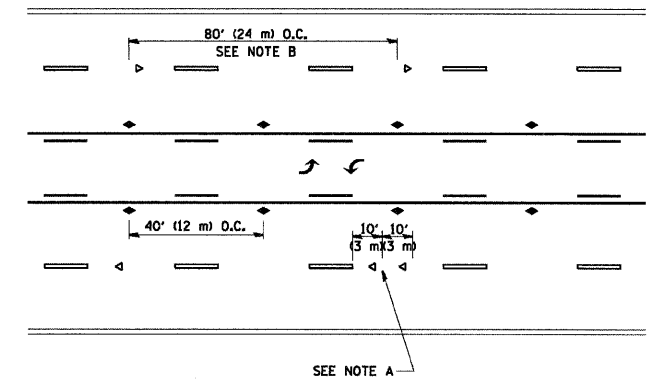

TWO-WAY LEFT TURN

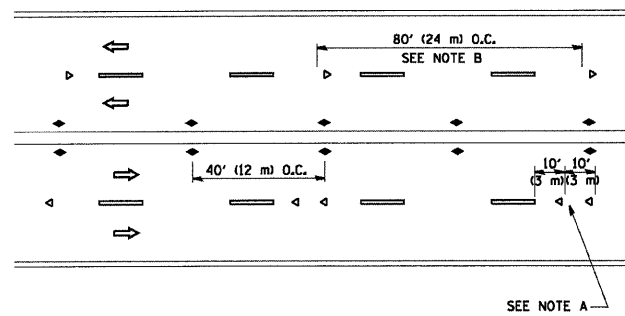

MULTI-LANE/UNDIVIDED

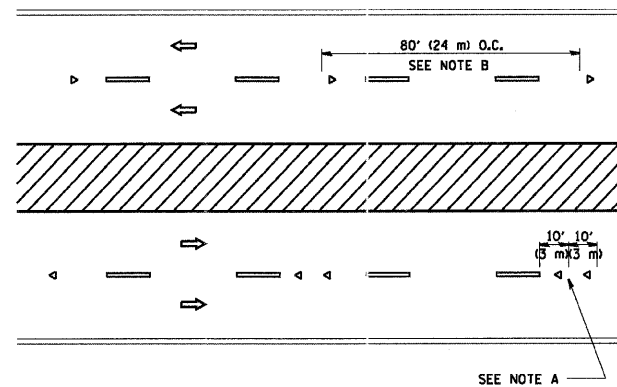

MULTI-LANE/DIVIDED

GENERAL NOTES

1. MARKERS USED WITH DASHED LINES SHALL BE CENTERED IN THE GAP BETWEEN SEGMENTS.
2. MARKERS USED ADJACENT TO SOLID LINES SHALL BE OFFSET 2 TO 3 (50 TO 75) TOWARD TRAFFIC AS SHOWN.
3. MARKERS THROUGH TANGENTS LESS THAN 500' (150 m) IN LENGTH BETWEEN CURVES SHALL BE INSTALLED AT THE LESSER OF THE TWO CURVE SPACINGS.

SYMBOLS

- YELLOW STRIPE
- WHITE STRIPE
- ◀ ONE-WAY AMBER MARKER
- ◄ ONE-WAY CRYSTAL MARKER (W/O)
- ◆ TWO-WAY AMBER MARKER

LANE MARKER NOTES

- A. USE DOUBLE LANE LINE MARKERS SPACED AS SHOWN.
- B. REDUCE TO 40' (12 m) O.C. ON CURVES WHERE ADVISORY SPEEDS ARE 10 M.P.H. (20 km/h) LOWER THAN POSTED SPEEDS.

DESIGN NOTES

1. DOUBLE LANE LINE MARKERS SHALL BE USED UNLESS SPECIFIED OTHERWISE.
2. EXCEPT AS SHOWN ON THE LANE REDUCTION TRANSITION AND FREEWAY EXIT RAMP DETAIL, MARKERS ARE NOT TO BE SPECIFIED ON RIGHT EDGE LINES.
3. THE EXACT MARKER LIMITS, SPACING, AND COLOR SHOULD BE INCLUDED IN THE PLANS.
4. MARKERS SHOULD NOT BE USED ALONGSIDE CURBS EXCEPT FOR EXTREMELY SHORT SECTIONS OF CURBS WHERE NOT MORE THAN TWO MARKERS WOULD BE INVOLVED.

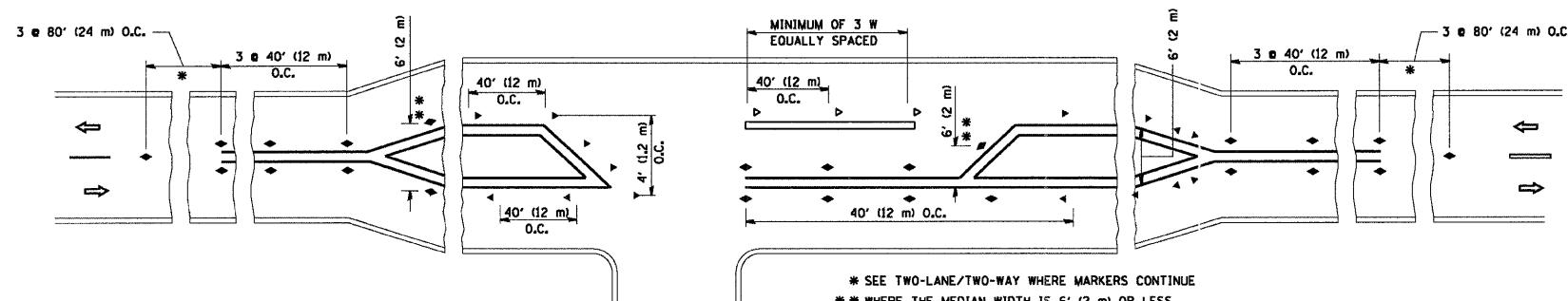

LEFT TURN

* SEE TWO-LANE/TWO-WAY WHERE MARKERS CONTINUE
 ** WHERE THE MEDIAN WIDTH IS 6' (2 m) OR LESS USE TWO-WAY MARKERS.

All dimensions are in inches (millimeters) unless otherwise shown.

FILE NAME = W:\dststd\22x34\td11.dgn	USER NAME = goglionobt	DESIGNED -	REVISED - T. RAMMACHER 09-19-94
	PLOT SCALE = 50,000' / IN.	DRAWN -	REVISED - T. RAMMACHER 03-12-99
	PLOT DATE = 1/4/2008	CHECKED -	REVISED - T. RAMMACHER 01-06-00
		DATE -	REVISED -

STATE OF ILLINOIS
 DEPARTMENT OF TRANSPORTATION

TYPICAL APPLICATIONS			
RAISED REFLECTIVE PAVEMENT MARKERS (SNOW-PLOW RESISTANT)			
SCALE: NONE	SHEET NO. 1 OF 1 SHEETS	STA.	TO STA.

F.A.I. RTE.	SECTION	COUNTY	TOTAL SHEETS	SHEET NO.
3726	(112 & 112X) RS-7	LAKE/COOK	19	14
TC-11			CONTRACT NO. 60H03	
FED. ROAD DIST. NO. 1 ILLINOIS FED. AID PROJECT				

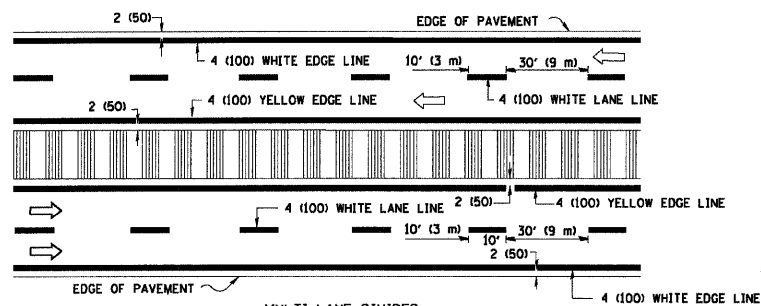
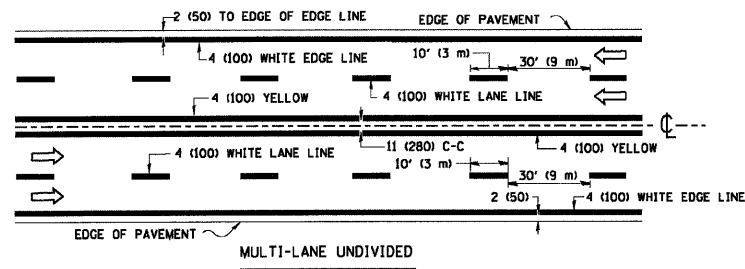
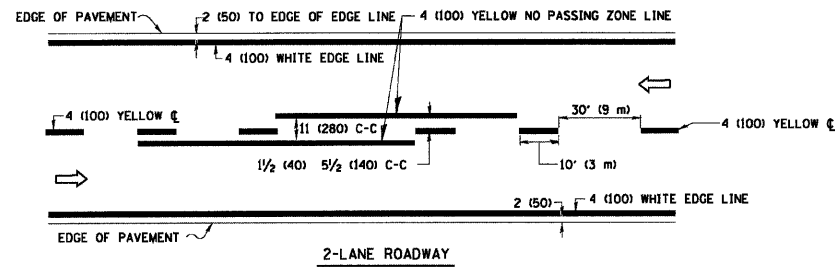

NOTE: MEDIANS WITH BARRIER CURB DO NOT REQUIRE AN EDGE LINE

TYPICAL LANE AND EDGE LINE MARKING

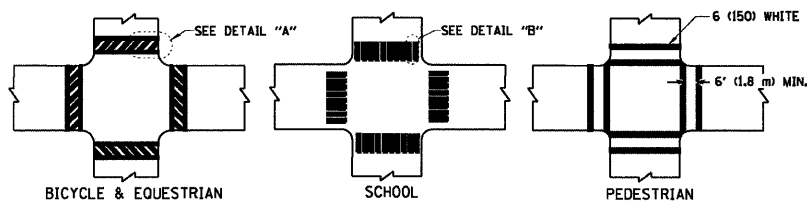

TYPICAL CROSSWALK MARKING

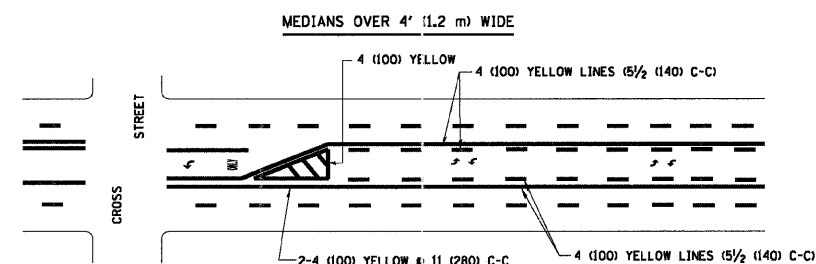
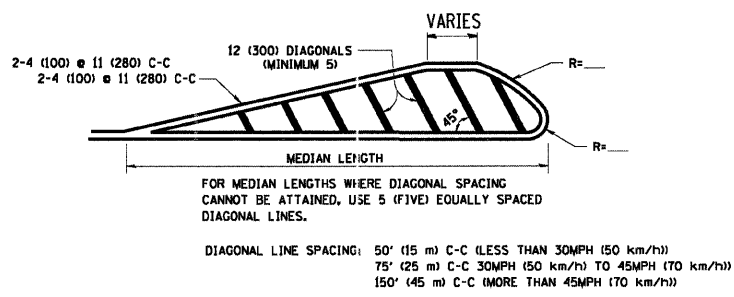
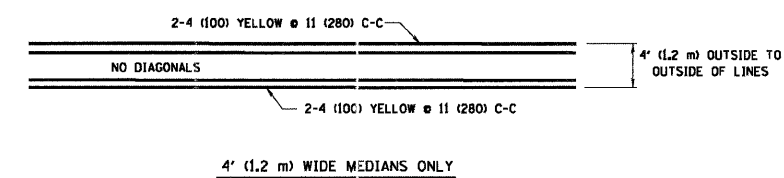

TYPICAL PAINTED MEDIAN MARKING

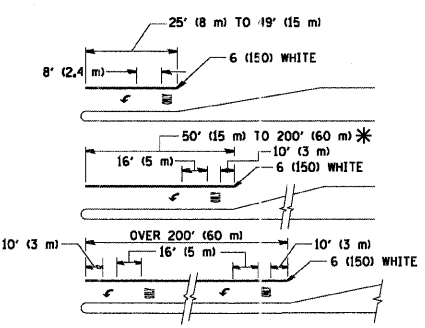

FULL SIZE LETTERS 8" (2.4 m) AND ARROWS SHALL BE USED.
 AREA = 15.6 SQ. FT. (1.5 m²) ONLY AREA = 20.8 SQ. FT. (1.9 m²)
 * TURN LANES IN EXCESS OF 400' (120 m) IN LENGTH MAY HAVE AN ADDITIONAL SET OF ARROW - "ONLY" INSTALLED MIDWAY BETWEEN THE OTHER TWO SETS OF ARROW - "ONLY".

TYPICAL TURN LANE MARKING

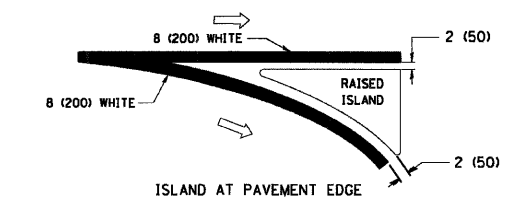
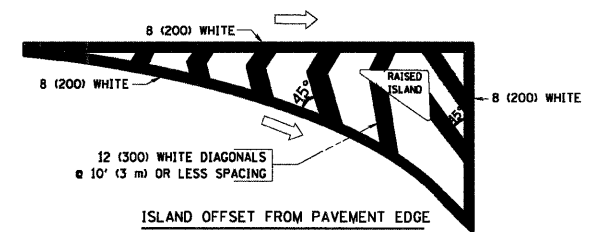

TYPICAL ISLAND MARKING

TYPE OF MARKING	WIDTH OF LINE	PATTERN	COLOR	SPACING / REMARKS
CENTERLINE ON 2 LANE PAVEMENT	4 (100)	SKIP-DASH	YELLOW	10' (3 m) LINE WITH 30' (9 m) SPACE
CENTERLINE ON MULTI-LANE UNDIVIDED PAVEMENT	2 @ 4 (100)	SOLID	YELLOW	11 (280) C-C
NO PASSING ZONE LINES: FOR ONE DIRECTION FOR BOTH DIRECTIONS	4 (100) 2 @ 4 (100)	SOLID SOLID	YELLOW YELLOW	5/2 (140) C-C FROM SKIP-DASH CENTERLINE 11 (280) C-C OMIT SKIP-DASH CENTERLINE BETWEEN
LANE LINES	4 (100) 5 (125) ON FREEWAYS	SKIP-DASH SKIP-DASH	WHITE WHITE	10' (3 m) LINE WITH 30' (9 m) SPACE
DOTTED LINES (EXTENSIONS OF CENTER, LANE OR TURN LANE MARKINGS)	SAME AS LINE BEING EXTENDED	SKIP-DASH	SAME AS LINE BEING EXTENDED	2' (600) LINE WITH 6' (1.8 m) SPACE
EDGE LINES	4 (100)	SOLID	YELLOW-LEFT WHITE-RIGHT	OUTLINE MOUNTABLE MEDIANS IN YELLOW. EDGE LINES ARE NOT USED NEXT TO BARRIER CURB
TURN LANE MARKINGS	6 (150) LINE; FULL SIZE LETTERS & SYMBOLS 18" (2.4m)	SOLID	WHITE	SEE TYPICAL TURN LANE MARKING DETAIL
TWO WAY LEFT TURN MARKING	2 @ 4 (100) EACH DIRECTION 8' (2.4m) LEFT ARROW	SKIP-DASH AND SOLID IN PAIRS	YELLOW WHITE	10' (3 m) LINE WITH 30' (9 m) SPACE FOR SKIP-DASH 5/2 (140) C-C BETWEEN SOLID LINE AND SKIP-DASH LINE SEE TYPICAL TWO-WAY LEFT TURN MARKING DETAIL
CROSSWALK LINES (PEDESTRIAN) A. DIAGONALS (BIKE & EQUESTRIAN) B. LONGITUDINAL BARS (SCHOOL)	2 @ 6 (150) 12 (300) @ 45° 12 (300) @ 90°	SOLID SOLID SOLID	WHITE WHITE WHITE	NOT LESS THAN 6' (1.8 m) APART 2' (600) APART 2' (600) APART SEE TYPICAL CROSSWALK MARKING DETAILS.
STOP LINES	24 (600)	SOLID	WHITE	PLACE 4' (1.2 m) IN ADVANCE OF AND PARALLEL TO CROSSWALK, IF PRESENT, OTHERWISE, PLACE AT DESIRED STOPPING POINT, PARALLEL TO CROSSROAD CENTERLINE, WHERE POSSIBLE
PAINTED MEDIANS	2 @ 4 (100) WITH 12 (300) DIAGONALS @ 45° NO DIAGONALS USED FOR 4' (1.2 m) WIDE MEDIANS	SOLID	YELLOW; TWO WAY TRAFFIC WHITE; ONE WAY TRAFFIC	11 (280) C-C FOR THE DOUBLE LINE SEE TYPICAL PAINTED MEDIAN MARKING.
GORE MARKING AND CHANNELIZING LINES	8 (200) WITH 12 (300) DIAGONALS @ 45°	SOLID	WHITE	DIAGONALS: 15' (4.5 m) C-C (LESS THAN 30MPH (50 km/h)) 20' (6 m) C-C (30MPH (50 km/h) TO 45MPH (70 km/h)) 30' (9 m) C-C (OVER 45MPH (70 km/h))
RAILROAD CROSSING	24 (600) TRANSVERSE LINES; "RR" 15 6" (1.8 m) LETTERS; 16 (400) LINE FOR "X"	SOLID	WHITE	SEE STATE STANDARD 780001 AREA OF: "R"=3.6 SQ. FT. (0.33 m ²) EACH "X"=64.0 SQ. FT. (5.0 m ²)
SHOULDER DIAGONALS	12 (300) @ 45°	SOLID	WHITE - RIGHT YELLOW - LEFT	50' (15 m) C-C (LESS THAN 30MPH (50 km/h)) 75' (25 m) C-C (30 MPH (50 km/h) TO 45MPH (70 km/h)) 150' (45 m) C-C (OVER 45MPH (70 km/h))

FOR FURTHER DETAILS ON PAVEMENT MARKING REFER TO STANDARD SPECIFICATIONS FOR ROAD AND BRIDGE CONSTRUCTION AND STATE STANDARD 780001.

All dimensions are in inches (millimeters) unless otherwise shown.

FILE NAME = W:\distrtd\22x34\vol3.dgn	USER NAME = geglennob	DESIGNED - EVERS	REVISED - T, RAMMACHER 10-27-94
	PLOT SCALE = 50,000' / IN.	DRAWN -	REVISED - A, HOUSEH 10-09-96
	PLOT DATE = 1/4/2008	CHECKED -	REVISED - A, HOUSEH 10-17-96
		DATE - 03-19-90	REVISED - T, RAMMACHER 01-06-00

**STATE OF ILLINOIS
DEPARTMENT OF TRANSPORTATION**

DISTRICT ONE		F.A.U. RTE.	SECTION	COUNTY	TOTAL SHEETS	SHEET NO.
TYPICAL PAVEMENT MARKINGS		3726	(112 & 112X) RS-7	LAKE/COOK	19	15
SCALE: NONE		SHEET NO. 1 OF 1 SHEETS		STA.	TO STA.	
		FED. ROAD DIST. NO. 1		ILLINOIS FED. AID PROJECT		

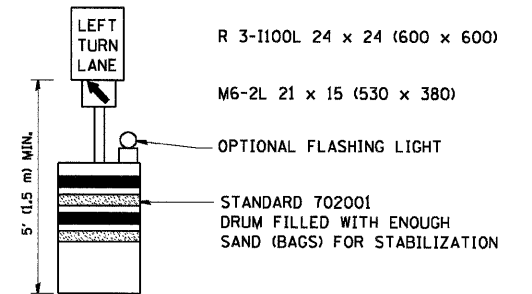
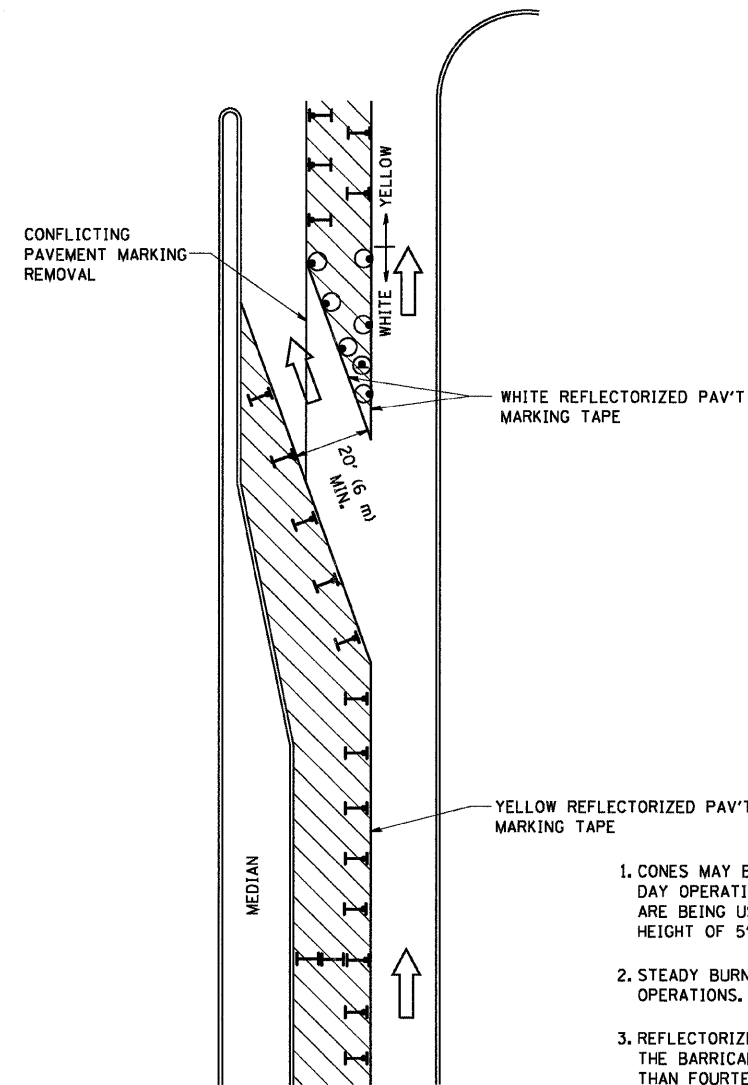







GENERAL NOTES

1. CONES MAY BE SUBSTITUTED FOR BARRICADES OR DRUMS AT HALF THE SPACING DURING DAY OPERATIONS. CONES SHALL BE A MINIMUM OF 28 (710) IN HEIGHT. WHEN CONES ARE BEING USED, THE "LEFT TURN LANE" SIGN MAY BE SKID MOUNTED AT A MINIMUM HEIGHT OF 5' (1.5 m).
2. STEADY BURNING LIGHTS WILL NOT BE REQUIRED ON BARRICADES OR DRUMS FOR DAY OPERATIONS. ALL LIGHTS SHALL BE MONODIRECTIONAL.
3. REFLECTORIZED TEMPORARY PAVEMENT MARKING TAPE SHALL BE PLACED THROUGHOUT THE BARRICADED AREA OF EACH TURN BAY WHERE THE CLOSURE TIME IS GREATER THAN FOURTEEN DAYS.
4. THIS APPLICATION ALSO APPLIES WHEN WORK IS BEING PERFORMED IN THE RIGHT LANE(S) AND THE RIGHT TURN BAY IS TO REMAIN OPEN. UNDER THIS CONDITION, "RIGHT TURN LANE" R3-100 24 x 24 (600 x 600) AND M6-2R 21 x 15 (530 x 380) SHALL BE USED.
5. THESE CONTROLS SHALL SUPPLEMENT MAINLINE TRAFFIC CONTROL FOR LANE CLOSURES.
6. LONGITUDINAL DIMENSIONS MAY BE ADJUSTED TO FIT FIELD CONDITIONS.
7. FORM BT 725 IS REQUIRED.
8. TRAFFIC CONTROL AND PROTECTION AT TURN BAYS (TO REMAIN OPEN TO TRAFFIC) SHALL BE INCLUDED IN THE COST SPECIFIED TRAFFIC CONTROL STANDARDS OR ITEMS.

All dimensions are in inches (millimeters) unless otherwise shown.

LEGEND

-  WORK AREA
-  LANE OPEN TO TRAFFIC
-  TYPE I OR II BARRICADE WITH STEADY BURN LIGHT
-  DRUM WITH STEADY BURN LIGHT
-  DRUM WITH SIGN (WITH OPTIONAL FLASHING LIGHT) SEE DETAIL
-  TYPE I OR II CHECK BARRICADE WITH FLASHING LIGHT

FILE NAME = W:\diststd\22x34\to14.dgn	USER NAME = geglienobt	DESIGNED -	REVISED -T. RAMMACHER 09-08-94
		DRAWN -	REVISED - A. HOUSEH 11-07-95
	PLOT SCALE = 50,0000 ' / IN.	CHECKED -	REVISED - A. HOUSEH 10-12-96
	PLOT DATE = 1/4/2008	DATE -	REVISED -T. RAMMACHER 01-06-00

**STATE OF ILLINOIS
DEPARTMENT OF TRANSPORTATION**

**TRAFFIC CONTROL AND PROTECTION AT TURN BAYS
(TO REMAIN OPEN TO TRAFFIC)**

SCALE: NONE SHEET NO. 1 OF 1 SHEETS STA. TO STA.

F.A.U. RTE.	SECTION	COUNTY	TOTAL SHEETS	SHEET NO.
3726	(112 & 112X) RS-7	LAKE/COOK	19	16
TC-14		CONTRACT NO. 60H03		
FED. ROAD DIST. NO. 1 ILLINOIS FED. AID PROJECT				

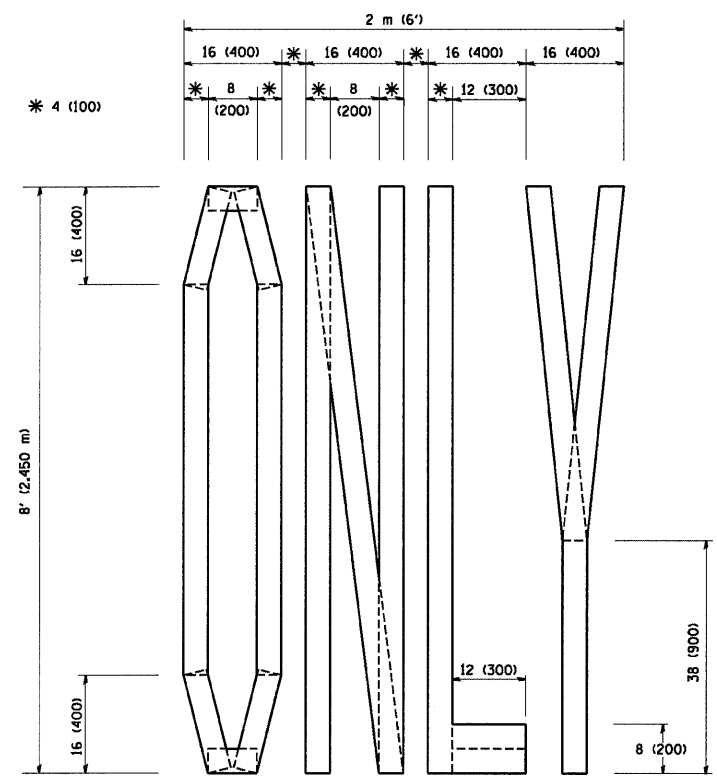

QUANTITY
4 (100) LINE = 64.1 ft. (19.7 m)
21.1 sq. ft. (1.97 sq. m)

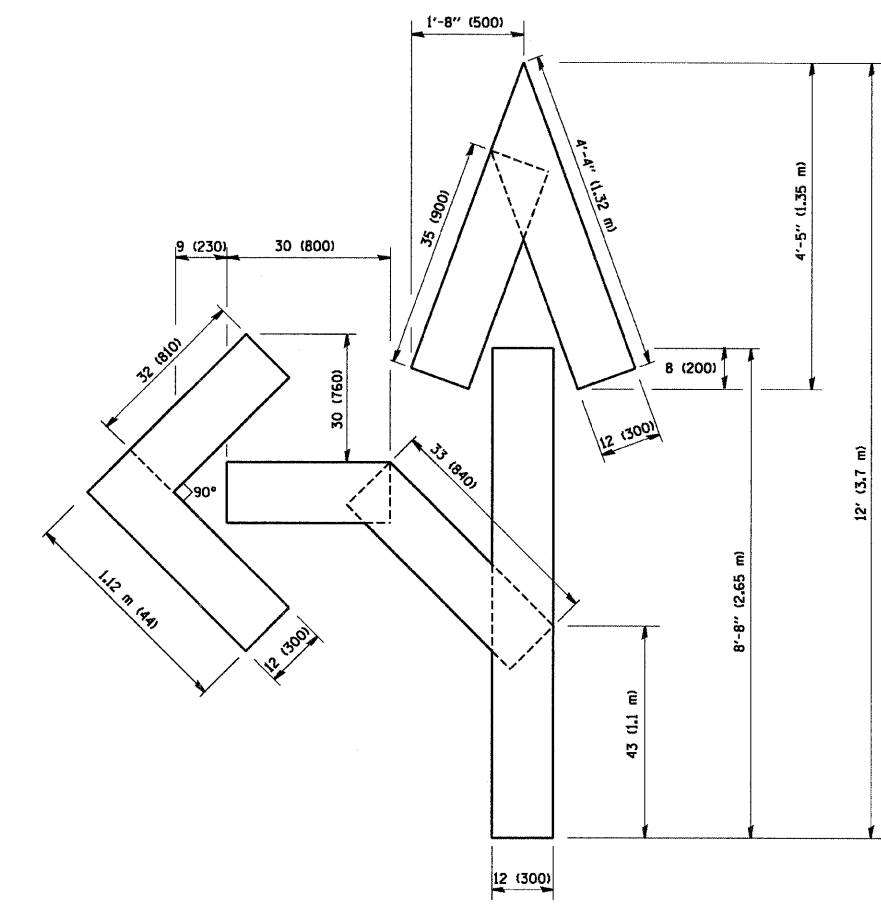

QUANTITY
4 (100) LINE = 82.5 ft. (25.3 m)
27.5 sq. ft. (2.53 sq. m)

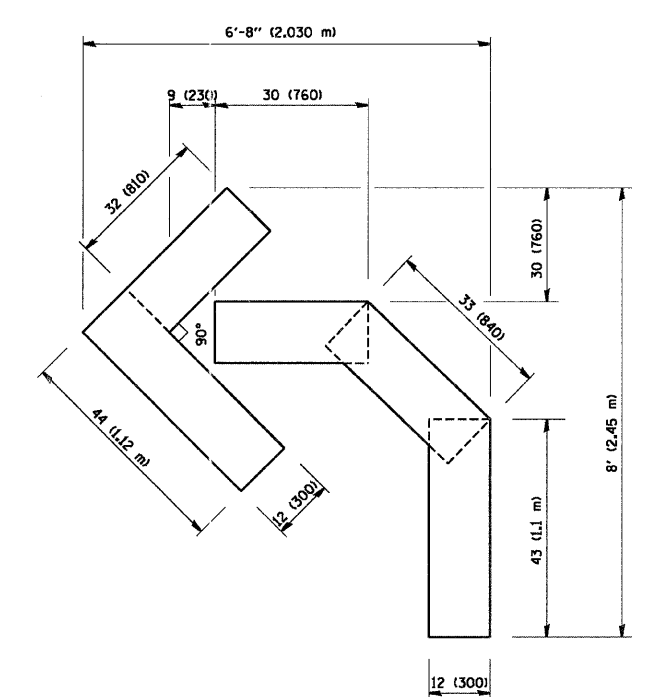

QUANTITY
4 (100) LINE = 45.5 ft. (13.9 m)
15.2 sq. ft. (1.39 sq. m)

All dimensions are in inches (millimeters) unless otherwise shown.

FILE NAME = W:\diststd\22x34\tol6.dgn	USER NAME = goglianobt	DESIGNED -	REVISED -T. RAMMACHER 06-05-96
		DRAWN -	REVISED -T. RAMMACHER 11-04-97
	PLOT SCALE = 50.0000 ' / IN.	CHECKED -	REVISED -T. RAMMACHER 03-02-98
	PLOT DATE = 1/4/2008	DATE - 09-18-94	REVISED -E. GOMEZ 08-28-00

STATE OF ILLINOIS
DEPARTMENT OF TRANSPORTATION

PAVEMENT MARKING LETTERS AND SYMBOLS FOR TRAFFIC STAGING			
SCALE: NONE	SHEET NO. 1 OF 1 SHEETS	STA.	TO STA.

F.A.U. RTE.	SECTION	COUNTY	TOTAL SHEETS	SHEET NO.
3726	(112 & 112X) RS-7	LAKE/COOK	19	17
TC-16			CONTRACT NO. 60H03	
FED. ROAD DIST. NO. 1 ILLINOIS FED. AID PROJECT				

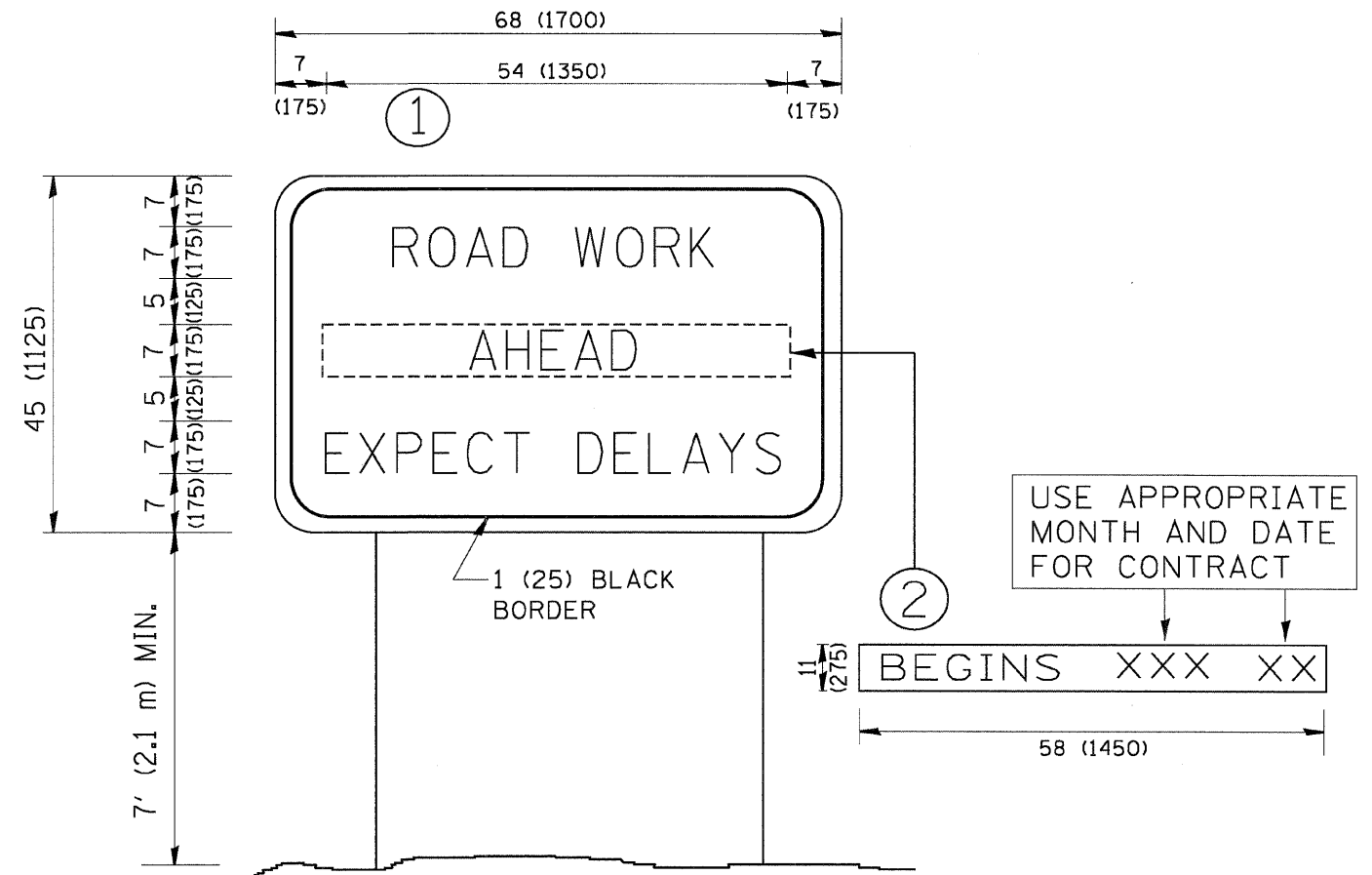

NOTES:

1. USE BLACK LETTERING ON ORANGE BACKGROUND.
2. ERECT SIGNS IN ADVANCE OF THE LOCATION FOR THE "ROAD CONSTRUCTION AHEAD" SIGN AT LOCATIONS AS DIRECTED BY THE ENGINEER.
3. ERECT SIGN ① WITH INSTALLED PANEL ② ONE WEEK PRIOR TO THE START OF CONSTRUCTION.
4. REMOVE PANEL ② SOON AFTER THE START OF CONSTRUCTION.
5. SEE SPECIAL PROVISION FOR "TEMPORARY INFORMATION SIGNING" FOR ADDITIONAL INFORMATION.
6. ONE SIGN ASSEMBLY EQUALS 25.70 SQ. FT. (2.3 SQ. M.)
7. SHALL BE PAID FOR AS TEMPORARY INFORMATION SIGNING.

ALL DIMENSIONS ARE IN INCHES (MILLIMETERS) UNLESS OTHERWISE SHOWN.

FILE NAME = W:\diststd\22x34\to22.dgn	USER NAME = gogliobt	DESIGNED -	REVISED - R. MIRS 09-15-97	STATE OF ILLINOIS DEPARTMENT OF TRANSPORTATION	ARTERIAL ROAD INFORMATION SIGN		F.A.U. RTE. 3726	SECTION (112 & 112X) RS-7	COUNTY LAKE/COOK	TOTAL SHEETS 19	SHEET NO. 18	
	PLOT SCALE = 50.000" / IN.	DRAWN -	REVISED - R. MIRS 12-11-97		SCALE: NONE	SHEET NO. 1 OF 1 SHEETS	STA.	TO STA.	TC-22	CONTRACT NO.	60H03	
	PLOT DATE = 1/4/2008	CHECKED -	REVISED - T. RAMMACHER 02-02-99		FED. ROAD DIST. NO. 1 ILLINOIS FED. AID PROJECT							
		DATE -	REVISED - C. JUCIUS 01-31-07									

LOOPS NEXT TO SHOULDERS

PROVIDE A PAVEMENT REPLACEMENT
NOTE WHICH SHOULD EQUAL
3' (900 mm) X WIDTH OF
PAVED SHOULDER.

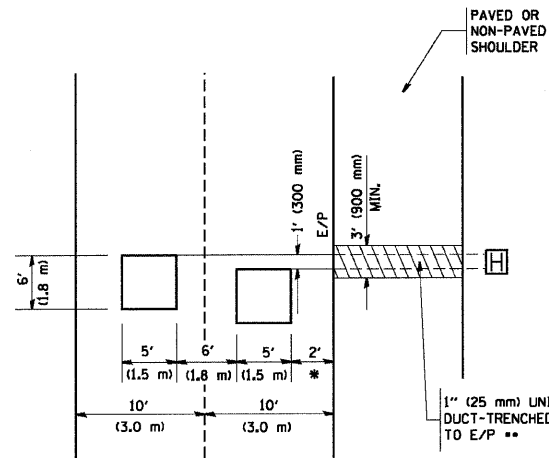

* = (600 mm)

** UNIT DUCT IS TO BE SHOWN ON PLAN SHEETS
BUT SHALL NOT BE INCLUDED IN THE PAY ITEMS.

**LEFT TURN LANES WITH MEDIANS
VOLUME DENSITY ("FAR OUT" DETECTION)
ON SAME APPROACH
(PROTECTED / PERMITTED LEFT TURN PHASING)**

HANDHOLE LOCATION MAY
VARY DEPENDING ON GEOMETRICS
AND DESIGN OF TRAFFIC SIGNALS.
HEAVY-DUTY HANDHOLES TO BE
USED WHEN THE MEDIAN IS
MOUNTABLE. REFER TO STANDARD
814001 TO ENSURE THAT HANDHOLE
FITS IN MEDIAN.

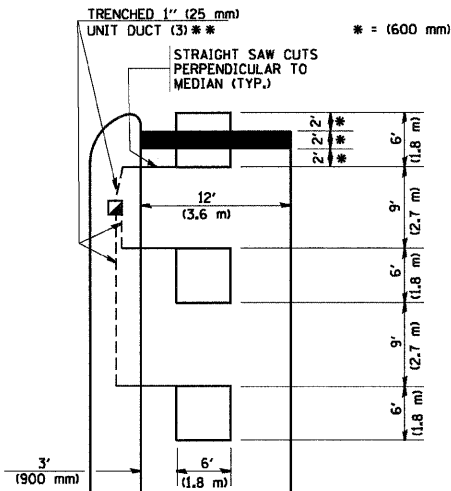

** UNIT DUCT IS TO BE SHOWN ON PLAN SHEETS
BUT SHALL NOT BE INCLUDED IN THE PAY ITEMS.

NOTE: DUAL LEFT TURNS NOT SHOWN REFER TO
PLAN SHEET FOR DETECTOR LOOP REPLACEMENT

**LEFT TURN LANES WITHOUT MEDIANS
VOLUME DENSITY ("FAR OUT" DETECTION)
ON SAME APPROACH
(PROTECTED / PERMITTED LEFT TURN PHASING)**

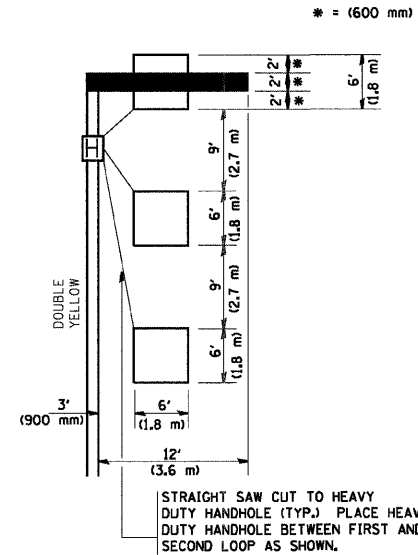

NOTE: DUAL LEFT TURNS NOT SHOWN REFER TO
PLAN SHEET FOR DETECTOR LOOP REPLACEMENT

**ARTERIAL-VOLUME DENSITY ("FAR OUT" DETECTION)
CROSS STREET-VOLUME DENSITY ("FAR OUT" DETECTION)**

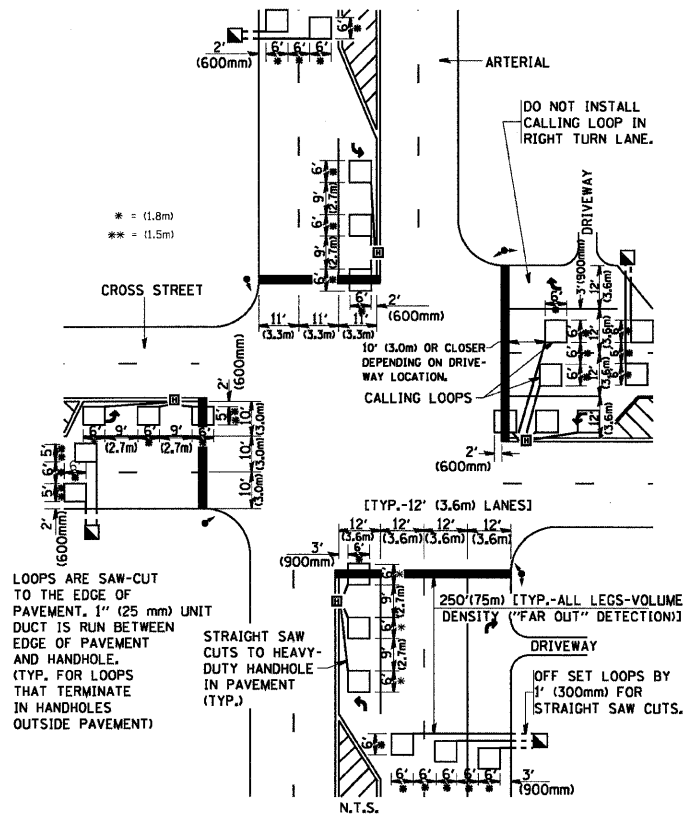

DETAIL 1
N.T.S.

**ARTERIAL-VOLUME DENSITY ("FAR OUT" DETECTION)
CROSS STREET-NON VOLUME DENSITY ("UPTIGHT" PRESENCE DETECTION)**

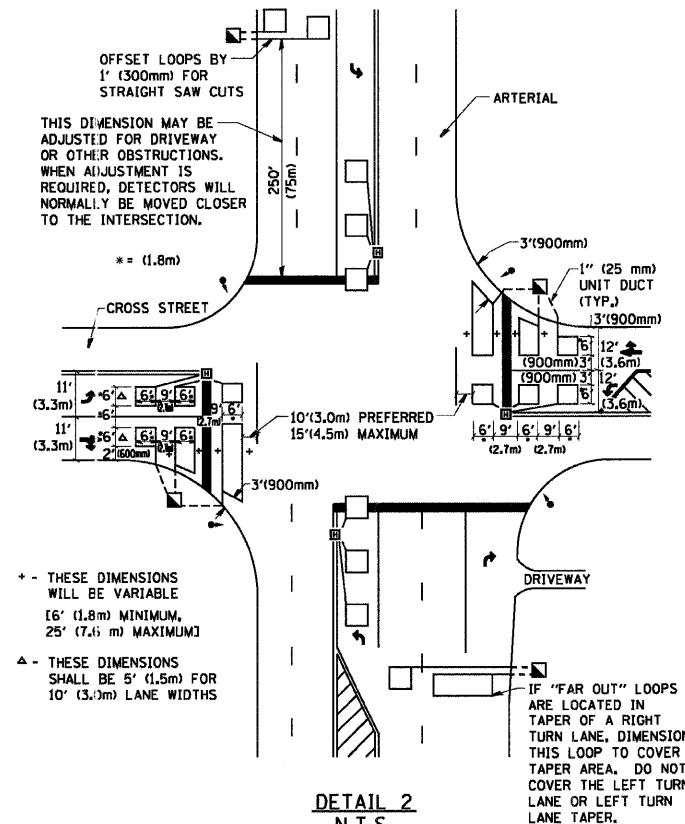

DETAIL 2
N.T.S.

NOTES:

VEHICLES LOOP DETECTORS

- * ALL LEAD IN CABLE SHALL BE TWO CONDUCTOR NO. 14 TWISTED, SHIELDED.
- * EACH DETECTOR LOOP SHALL HAVE ITS OWN SAW CUT FROM THE LOOP TO THE EDGE OF PAVEMENT OR TO A HANDHOLE IN THE PAVEMENT.
- * EACH DETECTOR LOOP SHALL HAVE ITS OWN ONE INCH (25 mm) UNIT DUCT BETWEEN THE EDGE OF PAVEMENT AND THE FIRST HANDHOLE OR JUNCTION BOX. EACH UNIT DUCT RUN SHALL BE SHOWN ON THE PLANS BY THE DESIGNER, BUT SHALL NOT BE PAID FOR SEPARATELY. THIS ITEM IS INCIDENTAL TO THE PAY ITEM FOR DETECTOR LOOPS.
- * ONE DIMENSION OF ALL DETECTOR LOOPS SHALL BE SIX FEET (1.8 m)
- * EACH LANE OF NON-LOCKING, PRESENCE DETECTION AND EACH LANE OF A DOUBLE LEFT TURN LANE REQUIRES A SEPARATE INDUCTIVE LOOP DETECTOR AND LEAD IN CABLE.
- * WHEN NON-LOCKING, PRESENCE DETECTION IS USED, MORE THAN ONE LOOP PER LANE IS REQUIRED BEHIND THE STOP BAR (i.e. 1-1/2, 1-3/4, 2).
- * WHEN SYSTEM LOOPS ARE REQUIRED ON AN APPROACH OF AN INTERSECTION, THE LOOPS USED FOR VOLUME DENSITY AND INTERSECTION TIMING SHALL ALSO BE USED AS SYSTEM DETECTORS. EACH ONE OF THESE TYPE OF LOOPS REQUIRES A SEPARATE TWO CONDUCTOR NO. 14 TWISTED SHIELDED CABLE AND A SEPARATE INDUCTIVE LOOP DETECTOR WHEN NEW CONTROLLERS ARE UTILIZED. THE DESIGNER SHALL LABEL THESE TYPES OF LOOPS AS "INTERSECTION AND SAMPLING (SYSTEM) DETECTORS" ON THE SIGNAL LAYOUT, THE INTERCONNECT PLAN AND THE SYSTEM CABLE PLAN. WHEN AN EXISTING CONTROLLER IS UTILIZED FOR THIS TYPE OF DETECTION, THE PAY ITEM "INDUCTIVE LOOP DETECTOR WITH SYSTEM OUTPUT" SHOULD BE USED.

PLACEMENT OF DETECTORS

THE FOLLOWING FIGURES REPRESENT THE MOST COMMON DETECTOR LOOP LOCATIONS AND SIZES. ADJUSTMENTS WILL BE NECESSARY FOR SPECIFIC GEOMETRIC CONSIDERATIONS.

LOCATIONS AND DIMENSIONS OF DETECTOR LOOPS ARE REQUIRED ON ALL SIGNAL LAYOUT PLAN SHEETS.

"FAR OUT" DETECTION REFERS TO LOCKING, PRESENCE TYPE DETECTION LOCATED IN THRU LANES, RIGHT TURN LANES, AND RIGHT TURN LANE TAPER AREAS (IF APPLICABLE), USUALLY 250' (75 m) IN ADVANCE OF STOP BARS. "UPTIGHT" DETECTION REFERS TO NON-LOCKING PRESENCE TYPE DETECTION LOCATED IN ALL LANES AND 10'-15' (3.0 m-4.5 m) BEHIND THE CROSSING STREET'S EDGE OF PAVEMENT EXTENDED.

NOTE:

ALL DETAILS AND NOTES SHOWN ARE FROM THE I.D.O.T. DISTRICT 1 TRAFFIC SIGNAL DESIGN GUIDELINES DATED JANUARY 1995

THIS DRAWING HAS BEEN PREPARED TO ASSIST THE RESIDENT ENGINEER FOR ALL ROADWAY RESURFACING OR S.M.A.R.T. PROJECTS WHERE THE DIMENSIONS ARE NOT SHOWN ON THE PLANS AND THE FINAL LOCATIONS FOR CROSSWALKS OR STOP BARS ARE NOT DETERMINED.

FILE NAME =

W:\data\ts\22x34\ts07.dgn

USER NAME = geglencbt

PLOT SCALE = 50.0000' / IN.

PLOT DATE = 1/4/2008

DESIGNED -

DRAWN -

CHECKED - R.K.F.

DATE -

REVISED -

REVISED -

REVISED -

REVISED -

**STATE OF ILLINOIS
DEPARTMENT OF TRANSPORTATION**

**DISTRICT 1 - DETECTOR LOOP INSTALLATION
DETAILS FOR ROADWAY RESURFACING**

SCALE: NONE

SHEET NO. 1 OF 1 SHEETS

STA.

TO STA.

F.A.U. RTE.

3726

SECTION

(112 & 112X) RS-7

TS-07

COUNTY

LAKE/COOK

CONTRACT NO.

60H03

TOTAL SHEETS

19

SHEET NO.

19

FED. ROAD DIST. NO. 1 ILLINOIS FED. AID PROJECT