

F.A.P. RTE.	SECTION	COUNTY	TOTAL SHEETS	SHEET NO.
400	124 RS-7	LAKE	17	1
		ILLINOIS	CONTRACT NO. 60H07	

STATE OF ILLINOIS
DEPARTMENT OF TRANSPORTATION
DIVISION OF HIGHWAYS

**PROPOSED
HIGHWAY PLANS**

F.A.P. ROUTE 400: OLD SKOKIE ROAD
WISCONSIN STATE LINE TO U.S. 41 (SKOKIE HWY.)
SECTION: 124 RS-7
RESURFACING
LAKE COUNTY
C-91-563-09

FOR INDEX OF SHEETS, SEE SHEET NO. 2

THE IMPROVEMENT IS LOCATED IN
THE VILLAGE OF WADSWORTH

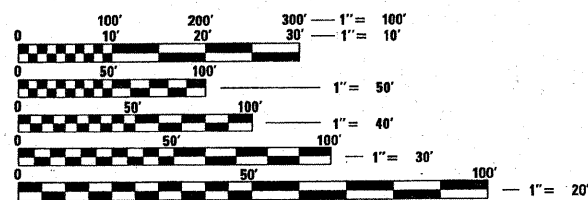
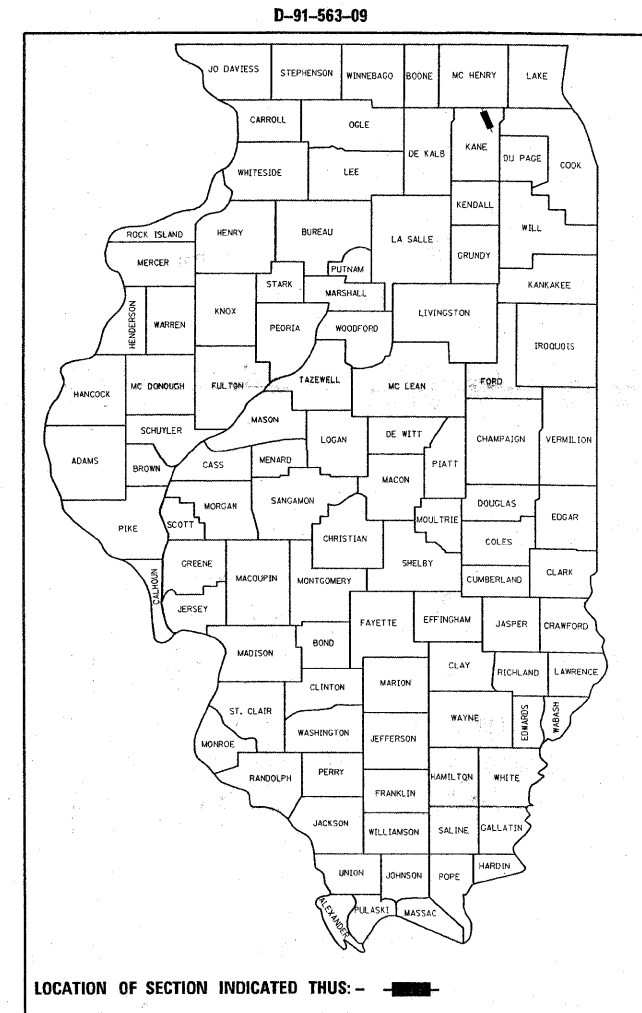

FULL SIZE PLANS HAVE BEEN PREPARED USING STANDARD ENGINEERING SCALES. REDUCED SIZED PLANS WILL NOT CONFORM TO STANDARD SCALES. IN MAKING MEASUREMENTS ON REDUCED PLANS, THE ABOVE SCALES MAY BE USED.

J.U.L.I.E.
JOINT UTILITY LOCATION INFORMATION FOR EXCAVATION
1-800-892-0123
OR 811

PROJECT ENGINEER ROBERT BORO (847) 705-4178
PROJECT MANAGER KEN ENG

CONTRACT NO. 60H07

IMPROVEMENT ENDS
STA. 103 + 73

OMISSION:
STA. 37 + 05 TO STA. 40 + 86

IMPROVEMENT BEGINS
STA. 23 + 93

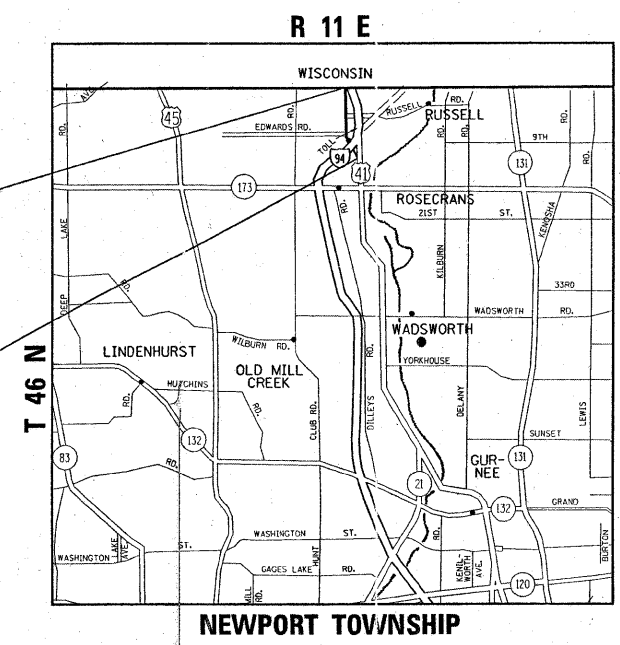

GROSS LENGTH OF IMPROVEMENT = 7,982 FT. = 1.51 MILE
NET LENGTH OF IMPROVEMENT = 7,601 FT. = 1.44 MILE

TRAFFIC DATA :
2007 ADT = 6,400
POSTED SPEED LIMIT = 55 MPH

STATE OF ILLINOIS
DEPARTMENT OF TRANSPORTATION
DIVISION OF HIGHWAYS

SUBMITTED APRIL 21, 2009

Diana M. O'Keefe
DEPUTY DIRECTOR OF HIGHWAYS, REGION ENGINEER

May 1, 2009
Charles J. Ingersoll
ENGINEER OF DESIGN AND ENVIRONMENT

May 1, 2009
Christine M. Reed
DIRECTOR OF HIGHWAYS, CHIEF ENGINEER

PRINTED BY THE AUTHORITY
OF THE STATE OF ILLINOIS

INDEX OF SHEETS

STATE STANDARDS

GENERAL NOTES

<u>SHEET NO.</u>	<u>DESCRIPTION</u>	<u>STANDARD NO.</u>	<u>DESCRIPTION</u>
1)-	TITLE SHEET	442201-03	CLASS C AND D PATCHES
2)-	INDEX OF SHEETS, STATE STANDARDS & GENERAL NOTES.	606001-04	CONCRETE CURB TYPE B AND COMBINATION CONCRETE CURB AND GUTTER
3)-	SUMMARY OF QUANTITIES	701301-03	LANE CLOSURE, 2L, 2W, SHORT TIME OPERATIONS
4-5)-	EXISTING AND PROPOSED TYPICAL SECTIONS	701601-00	URBAN LANE CLOSURE, MULTILANE, 1W OR 2W WITH NONTRAVERSABLE MEDIAN
6-8)-	ROADWAY AND PAVEMENT MARKING PLANS	701701-06	URBAN LANE CLOSURE, MULTILANE INTERSECTION
9)-	DETAILS FOR FRAMES AND LIDS ADJUSTMENT WITH MILLING, (BD-8)	701901-01	TRAFFIC CONTROL DEVICES
10)-	PAVEMENT PATCHING FOR HMA SURFACED PAVEMENT, (BD-22)		
11)-	BUTT JOINT AND HMA TAPER DETAILS, (BD-32)		
12)-	TRAFFIC CONTROL AND PROTECTION FOR SIDE ROADS, INTERSECTIONS AND DRIVEWAYS, (TC-10)		
13)-	TYPICAL APPLICATIONS: RAISED REFLECTIVE PAVEMENT MARKERS (SNOW-PLOW RESISTANT), (TC-11)		
14)-	DISTRICT ONE TYPICAL PAVEMENT MARKINGS, (TC-13)		
15)-	TRAFFIC CONTROL AND PROTECTION OF TURN BAYS (TO REMAIN OPEN TO TRAFFIC), (TC-14)		
16)-	PAVEMENT MARKING LETTERS AND SYMBOLS FOR TRAFFIC STAGING, (TC-16)		
17)-	ARTERIAL ROAD INFORMATION SIGN, (TC-22)		

BEFORE STARTING ANY EXCAVATION, THE CONTRACTOR SHALL CALL "J.U.L.I.E." AT (800) 892-0123 FOR FIELD LOCATIONS OF BURIED ELECTRIC, TELEPHONE, AND GAS FACILITIES. (48 HOUR NOTIFICATION REQUIRED)

THE CONTRACTOR SHALL COORDINATE CONSTRUCTION ACTIVITIES WITH UTILITY COMPANIES AND THE CITY OF CHICAGO HEIGHTS.

THE CONTRACTOR WILL NOT BE ABLE TO SET UP A YARD OR FIELD OFFICE ON STATE PROPERTY WITHOUT THE WRITTEN PERMISSION OF THE DEPARTMENT..

THE RESIDENT ENGINEER SHALL CONTACT MS. BEBBIE HANLON, AREA TRAFFIC FIELD ENGINEER, AT (847) 438-2300 A MINIMUM OF TWO WEEKS PRIOR TO PLACEMENT OF FINAL PAVEMENT MARKINGS.

WHEN MILLED PAVEMENT IS OPEN TO TRAFFIC, THE MAXIMUM GRADE DIFFERENTIAL BETWEEN PASSES OF THE MILLING MACHINE SHALL NOT EXCEED 1/2 INCHES WHERE THE SPEED LIMIT IS 45 MPH OR LESS, AND 1 INCH WHERE THE SPEED LIMIT IS 45 MPH. WITH WRITTEN APPROVAL FROM THE RESIDENT ENGINEER, A MAXIMUM GRADE DIFFERENTIAL OF 3 INCHES MAY BE ALLOWED IF THE EDGE OF THE MILLING IS SLOPED A MINIMUM OF 1:3 (V:H)

THE CONTRACTOR SHALL CONTACT THE TRAFFIC CONTROL SUPERVISOR AT (847) 705-4470 A MINIMUM OF 72 HOURS IN ADVANCE OF BEGINNING WORK.

ANY PAVEMENT MARKINGS AND RAISED REFLECTIVE PAVEMENT MARKERS OBLITERATED BY MILLING AND RESURFACING OPERATIONS ON SIDE STREETS AND ENTRANCES SHALL BE REPLACED AND PAID FOR IN KIND

ALL DAMAGE TO EXISTING PAVEMENT MARKINGS OR RAISED REFLECTIVE PAVEMENT MARKERS OUTSIDE THE REMOVAL LINE SHOWN ON THE PLANS SHALL BE REPLACED AT NO ADDITIONAL COST TO THE DEPARTMENT.

BEFORE BEGINNING ANY WORK, THE CONTRACTOR SHALL RETAIN AND RECORD FOR FUTURE REFERENCE, ALL EXISTING PAVEMENT MARKING LINES (AND RAISED REFLECTIVE PAVEMENT MARKERS) IN ORDER THAT THESE LOCATIONS CAN BE RE-ESTABLISHED FOR STRIPING. EXACT LOCATIONS OF ALL PAVEMENT MARKINGS SHALL BE AS DIRECTED BY THE ENGINEER.

ALL PAVEMENT PATCHING LOCATIONS WILL BE DETERMINED IN THE FIELD BY THE ENGINEER.

DRAINAGE ADJUSTMENT OR RECONSTRUCTION LOCATIONS WILL BE DETERMINED IN THE FIELD BY THE ENGINEER.

IT SHALL BE THE CONTRACTOR'S RESPONSIBILITY TO VERIFY ALL DIMENSIONS AND CONDITIONS EXISTING IN THE FIELD PRIOR TO CONSTRUCTION AND ORDERING OF MATERIALS.

THE CONTRACTOR SHALL BE REQUIRED TO PROVIDE ACCESS TO ABUTTING PROPERTY AT ALL TIMES DURING THE CONSTRUCTION OF THIS PROJECT.

DO NOT SCALE PLANS FOR CONSTRUCTION DIMENSIONS.

DOUBLE LANE MARKERS ARE TO BE USED AS SHOWN ON THE DISTRICT ONE DETAIL "TYPICAL APPLICATIONS - RAISED REFLECTIVE PAVEMENT MARKERS (SNOW-PLOW RESISTANT)" SHOWN IN THE PLANS.

PAVEMENT MARKING TAPE, TYPE III SHALL BE USED FOR SHORT TERM PAVEMENT MARKINGS ON ALL FINAL SURFACES. THE COST OF THE PAVEMENT MARKING TAPE, TYPE III AND ITS REMOVAL SHALL BE INCLUDED IN THE COST OF SHORT TERM PAVEMENT MARKING.

FILE NAME =	USER NAME = hamdonah	DESIGNED -	REVISED -	STATE OF ILLINOIS DEPARTMENT OF TRANSPORTATION	OLD SKOKIE ROAD WISCONSIN STATE LINE TO U.S. 41 (SKOKIE HWY.) INDEX OF SHEETS, STATE STANDARDS AND GENERAL NOTES PLAN	F.A.P. RTE.	SECTION	COUNTY	TOTAL SHEETS	SHEET NO.
te:\pwwork\pwwork\hamdonah\0137088\0154309-sh.tplan.dgn	DRAWN -	REVISED -	400			124 RS-7	LAKE	17	2	
PLOT SCALE = 50.0000' / IN.	CHECKED -	REVISED -	CONTRACT NO. 60H07							
PLOT DATE = 4/21/2009	DATE -	REVISED -	ILLINOIS FED. AID PROJECT							
					SCALE: N.T.S.	SHEET NO. 1 OF 1 SHEETS		STA.	TO STA.	

SUMMARY OF QUANTITIES				CONSTRUCTION TYPE CODE					SUMMARY OF QUANTITIES				CONSTRUCTION TYPE CODE						
CODE NO	ITEM	UNIT	TOTAL QUANTITIES	1000						CODE NO	ITEM	UNIT	TOTAL QUANTITIES	1000					
			URBAN 100% STATE										URBAN 100% STATE						
40600200	BITUMINOUS MATERIALS (PRIME COAT)	TON	15	15						X032256	TEMPORARY INFORMATION SIGNING	SO FT	106.3	106.3					
40600300	AGGREGATE (PRIME COAT)	TON	76	76						X4067107	POLYMERIZED LEVELING BINDER (MACHINE METHOD), 1L-4.75, N50	TON	1485	1485					
40600400	MIXTURE FOR CRACKS, JOINTS, AND FLANGEWAYS	TON	11	11						XX002258	STRUCTURES TO BE ADJUSTED	EACH	1	1					
40600895	CONSTRUCTING TEST STRIP	EACH	1	1						20018200	DRAINAGE STRUCTURE RECONSTRUCTION (SPECIAL)	EACH	1	1					
40600982	HOT-MIX ASPHALT SURFACE REMOVAL - BUTT JOINT	SO YD	93	93						20018500	DRAINAGE STRUCTURES TO BE CLEANED	EACH	7	7					
40601005	HOT-MIX ASPHALT REPLACEMENT OVER PATCHES	TON	45	45															
40603340	HOT-MIX ASPHALT SURFACE COURSE, MIX "D", N70	TON	3168	3168															
44000159	HOT-MIX ASPHALT SURFACE REMOVAL, 2 1/2"	SO YD	37717	37717															
44002215	HOT-MIX ASPHALT REMOVAL OVER PATCHES, 3 3/4"	SO YD	1974	1974															
44201741	CLASS D PATCHES, TYPE II, 8 INCH	SO YD	1000	1000															
44201745	CLASS D PATCHES, TYPE III, 8 INCH	SO YD	200	200															
44201747	CLASS D PATCHES, TYPE IV, 8 INCH	SO YD	720	720															
55039700	STORM SEWERS TO BE CLEANED	FOOT	350	350															
60603800	COMBINATION CONCRETE CURB AND GUTTER, TYPE B-6.12	FOOT	200	200															
67000400 67100100	ENGINEER'S FIELD OFFICE, TYPE A MOBILIZATION	CAL MO L SUM	0 1	0 1															
70102630	TRAFFIC CONTROL AND PROTECTION, STANDARD 701601	L SUM	1	1															
70102635	TRAFFIC CONTROL AND PROTECTION, STANDARD 701701	L SUM	1	1															
70300100	SHORT-TERM PAVEMENT MARKING	FOOT	2407	2407															
70300210	TEMPORARY PAVEMENT MARKING - LETTERS AND SYMBOLS	SO FT	100	100															
70300220	TEMPORARY PAVEMENT MARKING - LINE 4"	FOOT	25378	25378															
70300250	TEMPORARY PAVEMENT MARKING - LINE 8"	FOOT	1098	1098															
70300260	TEMPORARY PAVEMENT MARKING - LINE 12"	FOOT	1378	1378															
* 78000100	THERMOPLASTIC PAVEMENT MARKING - LETTERS AND SYMBOLS	SO FT	100	100															
* 78000200	THERMOPLASTIC PAVEMENT MARKING - LINE 4"	FOOT	25378	25378															
* 78000500	THERMOPLASTIC PAVEMENT MARKING - LINE 8"	FOOT	1098	1098															
* 78000600	THERMOPLASTIC PAVEMENT MARKING - LINE 12"	FOOT	1378	1378															
* 78100100	RAISED REFLECTIVE PAVEMENT MARKER	EACH	340	340															
78300200	RAISED REFLECTIVE PAVEMENT MARKER REMOVAL	EACH	173	173															

* Specialty Items

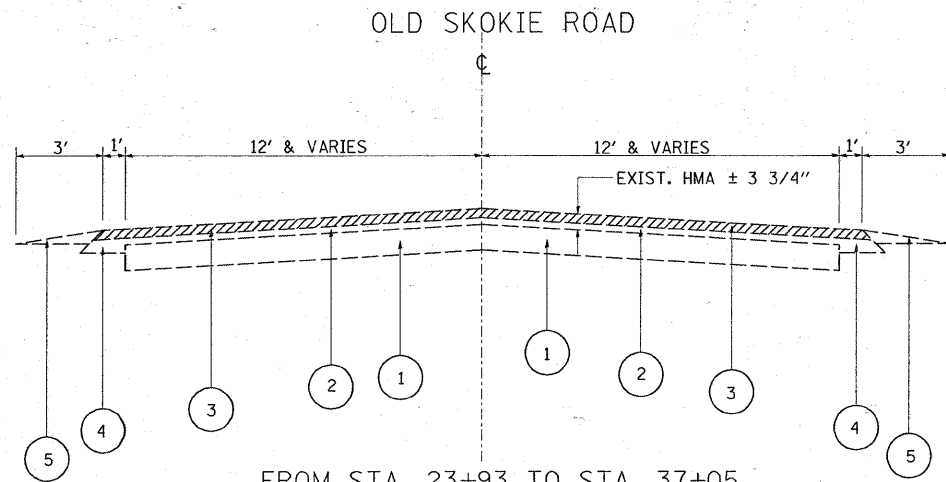

FROM STA. 23+93 TO STA. 37+05
AND
FROM STA. 40+86 STA. 53+62

**EXIST. TYPICAL SECTION
OLD SKOKIE ROAD**

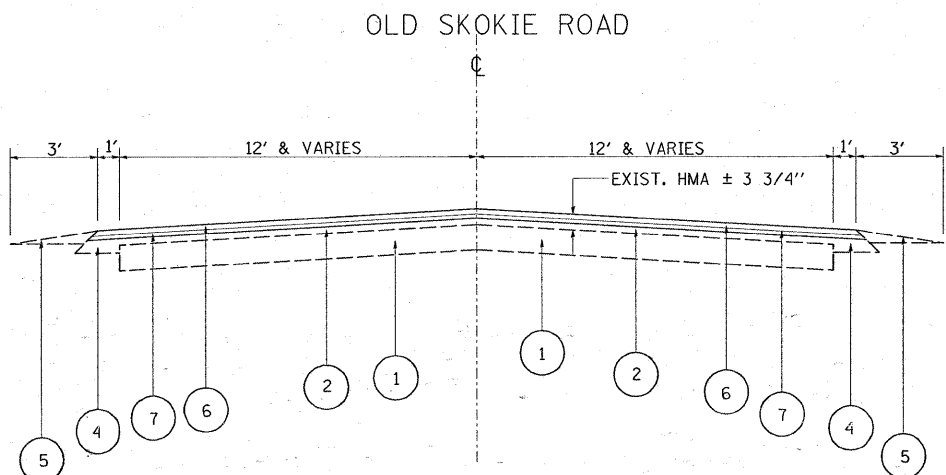

FROM STA. 23+93 TO STA. 37+05
AND
FROM STA. 40+86 STA. 53+62

**PROPOSED TYPICAL SECTION
OLD SKOKIE ROAD**

LEGEND

- ① EXIST. PCC PAVEMENT 8"
- ② EXIST. REMAINING HMA AFTER MILLING, ± 1/2 "
- ③ PROP. HOT-MIX ASPHALT SURFACE REMOVAL 2 1/4 "
- ④ EXIST. HOT MIX ASPHALT SHOULDER
- ⑤ EXIST. AGGREGATE SHOULDERS
- ⑥ PROP. HOT-MIX ASPHALT SURFACE COURSE, MIX "D", N70, 1 1/2 "
- ⑦ PROP. POLYMERIZED LEVELING BINDER (MM), IL-4.75, N50, 3/4 "
- ⑧ EXIST. PCC PAVEMENT 9"
- ⑨ EXIST. COMBINATION CONCRETE CURB AND GUTTER, TYPE B-6.12

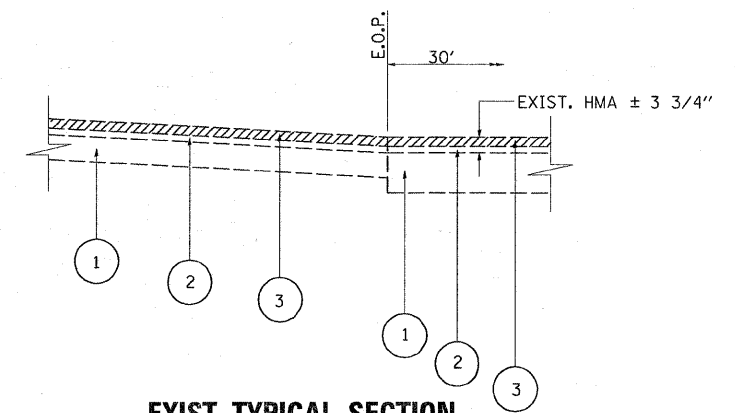

**EXIST. TYPICAL SECTION
AT CROSSOVER**

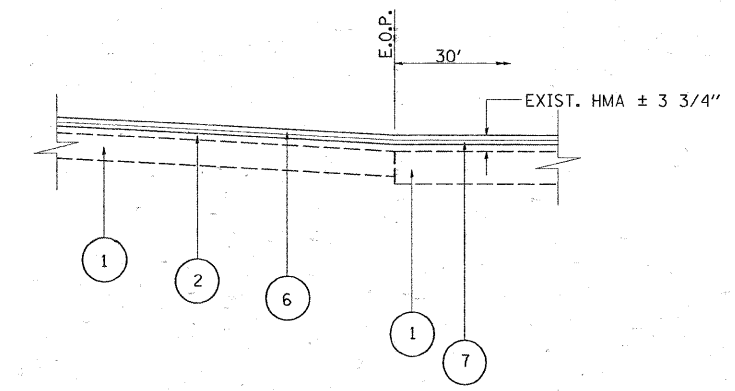

**PROPOSED TYPICAL SECTION
AT CROSSOVER**

NOTE: CONTRACTOR SHALL PATCH FIRST BEFORE MILLING

FILE NAME =	USER NAME = hamdanah	DESIGNED -	REVISED -	STATE OF ILLINOIS DEPARTMENT OF TRANSPORTATION	OLD SKOKIE ROAD WISCONSIN STATE LINE TO U.S. 41 (SKOKIE HWY.) TYPICAL SECTIONS PLANS	F.A.P. RTE.	SECTION	COUNTY	TOTAL SHEETS	SHEET NO.	
net:\pwork\pwork\hamdanah\08137088\0156309-sh.t.plandgn	PLOT SCALE = 50.0000' / IN.	DRAWN -	REVISED -			400	124 RS-7	LAKE	17	4	
	PLOT DATE = 4/21/2009	CHECKED -	REVISED -			CONTRACT NO. 60H07					
		DATE -	REVISED -			SCALE: N.T.S.	SHEET NO. 1 OF 2 SHEETS	STA.	TO STA.	ILLINOIS FED. AID PROJECT	

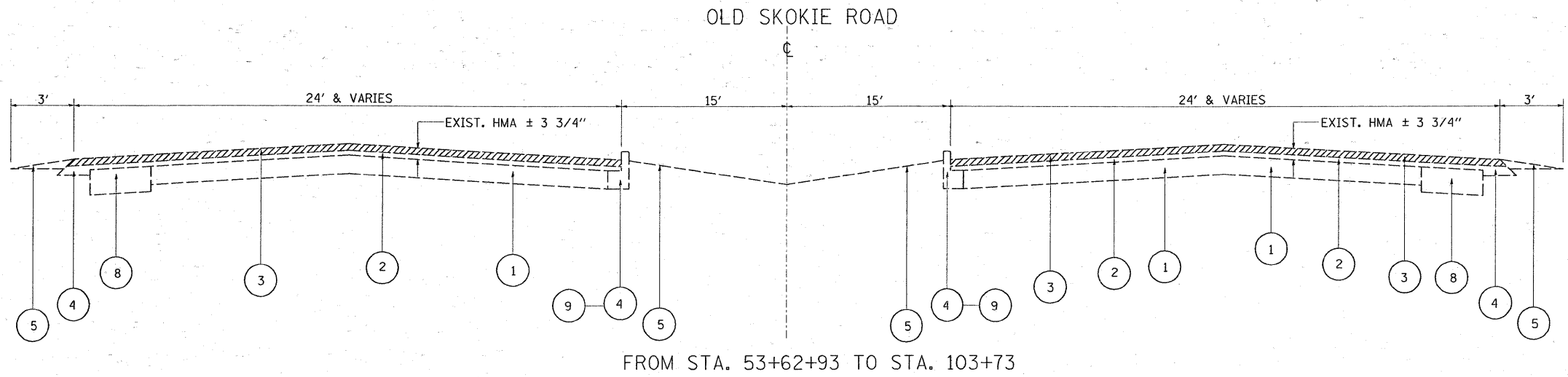

**EXIST. TYPICAL SECTION
OLD SKOKIE ROAD**

- LEGEND**
- ① EXIST. PCC PAVEMENT 8"
 - ② EXIST. REMAINING HMA AFTER MILLING, ± 1/2 "
 - ③ PROP. HOT-MIX ASPHALT SURFACE REMOVAL 2 1/4 "
 - ④ EXIST. HOT MIX ASPHALT SHOULDER
 - ⑤ EXIST. AGGREGATE SHOULDERS
 - ⑥ PROP. HOT-MIX ASPHALT SURFACE COURSE, MIX "D", N70, 1 1/2 "
 - ⑦ PROP. POLYMERIZED LEVELING BINDER (MM), IL-4.75, N50, 3/4 "
 - ⑧ EXIST. PCC PAVEMENT 9"
 - ⑨ EXIST. COMBINATION CONCRETE CURB AND GUTTER, TYPE B-6.12

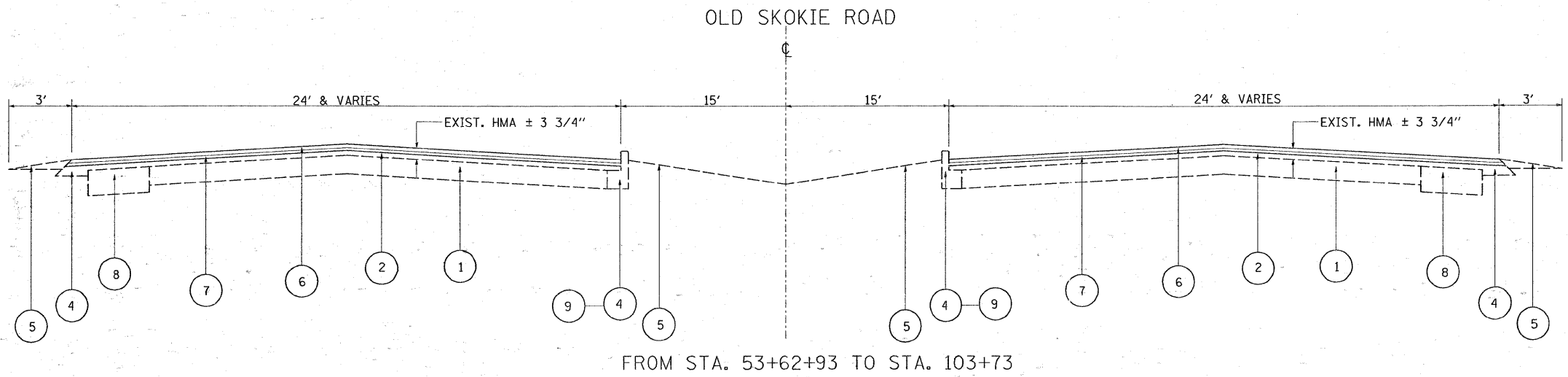

**PROPOSED TYPICAL SECTION
OLD SKOKIE ROAD**

HOT-MIX ASPHALT MIXTURE REQUIREMENTS

MIXTURE TYPE	AC TYPE	AIR VOIDS
HOT-MIX ASPHALT SURFACE COURSE, MIX "D", N70 (IL 9.5 mm)	PG 64-22	4% @ 70 GYR
POLYMERIZED LEVELING BINDER, (MM), IL-4.75, N50	SBS/SBR PG 76-28/-22	4% @ 50 GYR
CLASS D PATCHES, (HMA BINDER IL-19 mm)	PG 64-22*	4% @ 70 GYR

THE UNIT WEIGHT USED TO CALCULATE ALL HOT-MIX ASPHALT SURFACE MIXTURE QUANTITIES IS 112 LBS/SQYD/IN.
*WHEN RAP EXCEEDS 20%, THE NEW ASPHALT BINDER IN THE MIX SHALL BE PG 58-22

NOTE: CONTRACTOR SHALL PATCH FIRST BEFORE MILLING

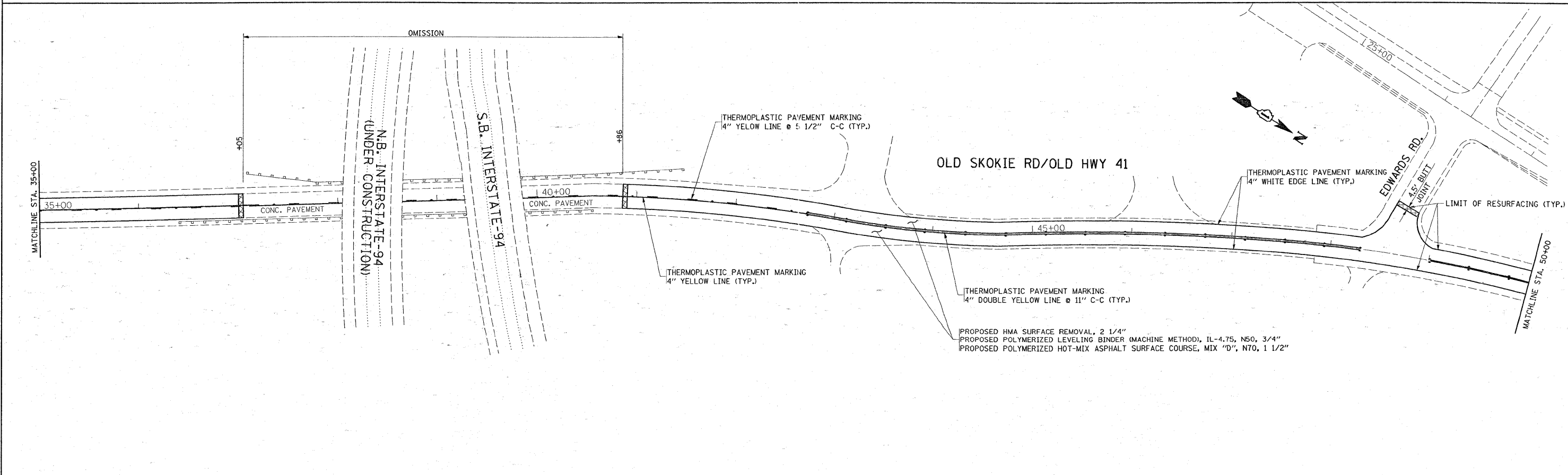
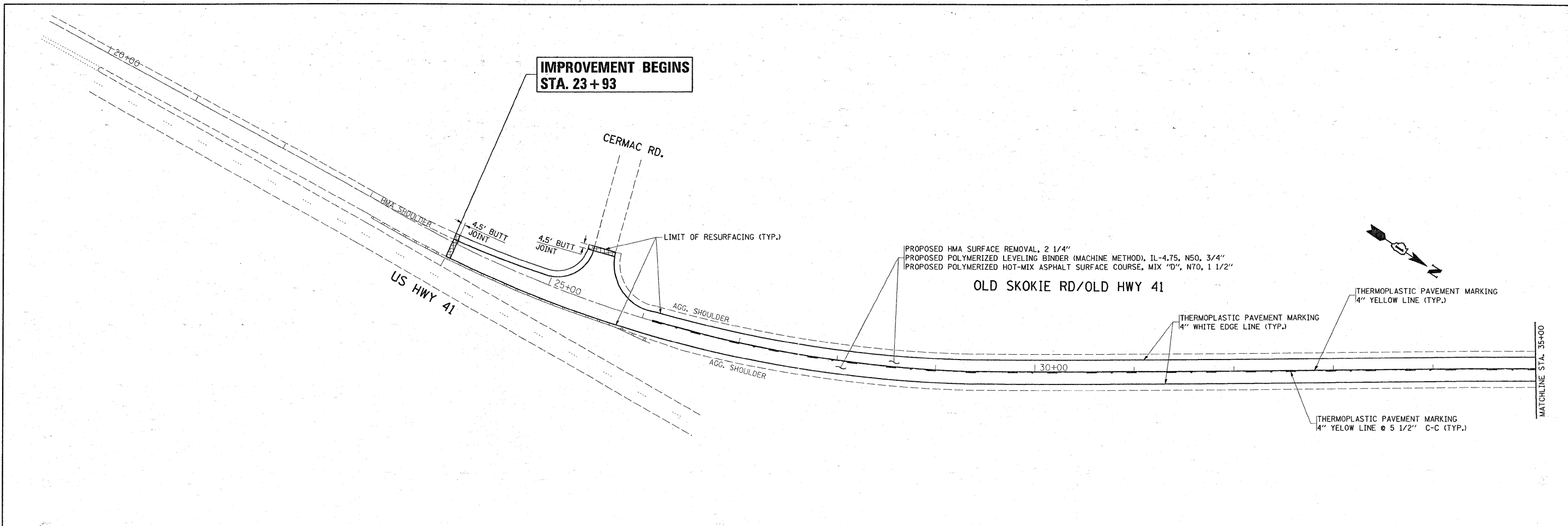

FILE NAME =	USER NAME = hamdonah	DESIGNED -	REVISED -	STATE OF ILLINOIS DEPARTMENT OF TRANSPORTATION	OLD SKOKIE ROAD WISCONSIN STATE LINE TO U.S. 41 (SKOKIE HWY.) ROADWAY AND PAVEMENT MARKING PLAN	F.A.P. RTE.	SECTION	COUNTY	TOTAL SHEETS	SHEET NO.	
c:\pwwork\pwwork\hamdonah\0137088\015309-shd.pln.dgn	PLOT SCALE = 50.0000' / IN.	DRAWN -	REVISED -			400	124 RS-7	LAKE	17	6	
PLOT DATE = 4/21/2009	DATE -	CHECKED -	REVISED -			SCALE: 1"=50' SHEET NO. 1 OF 3 SHEETS STA. 23+93 TO STA. 50+00 ILLINOIS FED. AID PROJECT CONTRACT NO. 60H07					
		DATE -	REVISED -								

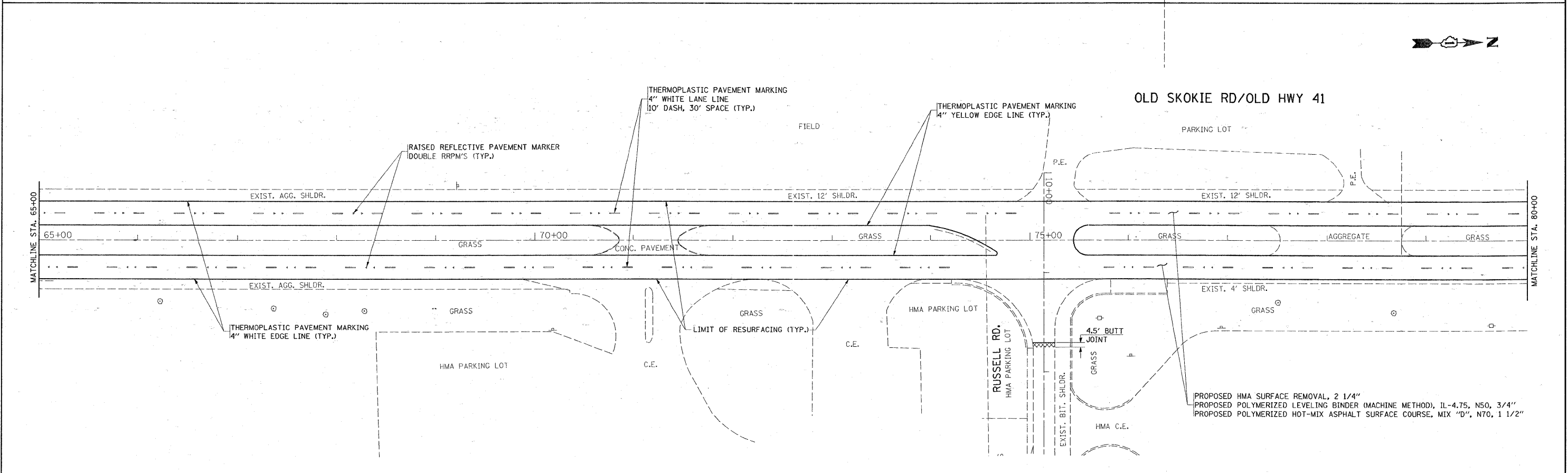
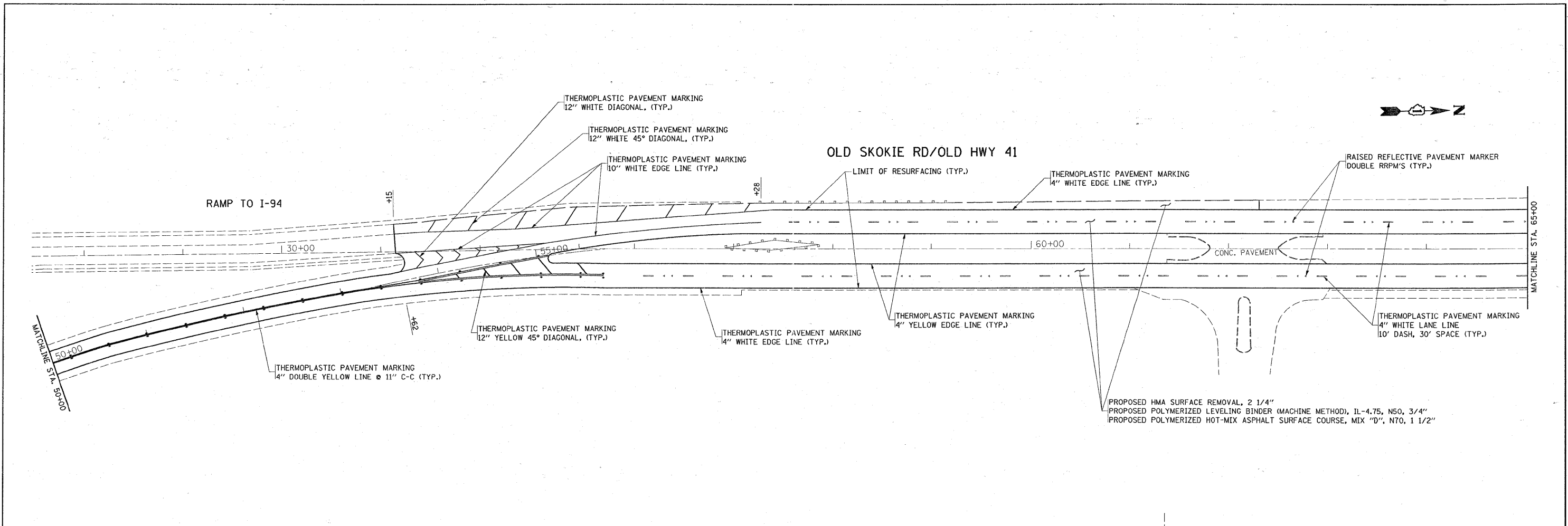

FILE NAME =	USER NAME = hmdanah	DESIGNED -	REVISED -	STATE OF ILLINOIS DEPARTMENT OF TRANSPORTATION	OLD SKOKIE ROAD WISCONSIN STATE LINE TO U.S. 41 (SKOKIE HWY.) ROADWAY AND PAVEMENT MARKING PLAN			F.A.P. RTE.	SECTION	COUNTY	TOTAL SHEETS	SHEET NO.
c:\pe_work\pxidot\hmdanah\0137088\0154309-sht.pln.dgn		DRAWN -	REVISED -		SCALE: 1"=50'	SHEET NO. 2 OF 3 SHEETS	STA. 50+00 TO STA. 80+00	400	124 RS-7	LAKE	17	7
PLOT SCALE = 50,0000 "/> IN.		CHECKED -	REVISED -									
PLOT DATE = 4/21/2009		DATE -	REVISED -									
ILLINOIS FED. AID PROJECT												

OLD SKOKIE RD/OLD HWY 41

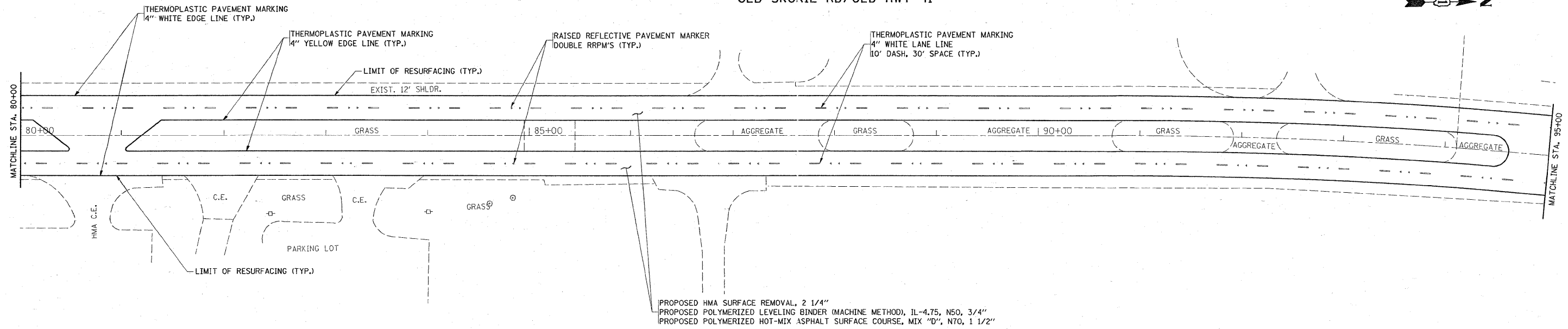

PROPOSED HMA SURFACE REMOVAL, 2 1/4"
 PROPOSED POLYMERIZED LEVELING BINDER (MACHINE METHOD), IL-4.75, N50, 3/4"
 PROPOSED POLYMERIZED HOT-MIX ASPHALT SURFACE COURSE, MIX "D", N70, 1 1/2"

OLD SKOKIE RD/OLD HWY 41

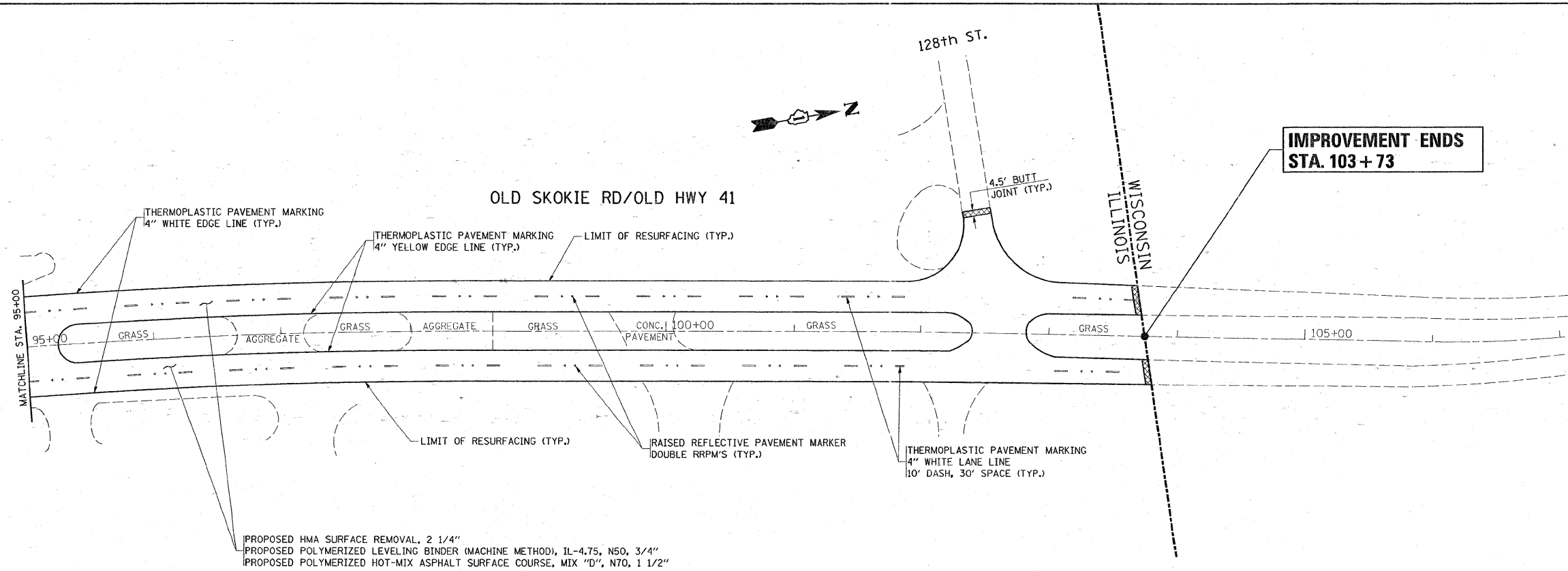

**IMPROVEMENT ENDS
 STA. 103+73**

PROPOSED HMA SURFACE REMOVAL, 2 1/4"
 PROPOSED POLYMERIZED LEVELING BINDER (MACHINE METHOD), IL-4.75, N50, 3/4"
 PROPOSED POLYMERIZED HOT-MIX ASPHALT SURFACE COURSE, MIX "D", N70, 1 1/2"

FILE NAME =	USER NAME = hamdanah	DESIGNED -	REVISED -	STATE OF ILLINOIS DEPARTMENT OF TRANSPORTATION	OLD SKOKIE ROAD WISCONSIN STATE LINE TO U.S. 41 (SKOKIE HWY.) ROADWAY AND PAVEMENT MARKING PLAN	F.A.P. RTE.	SECTION	COUNTY	TOTAL SHEETS	SHEET NO.	
ca:\pwr\work\pwr\dot\hamdanah\01370889\0156309-sh.tplan.dgn		DRAWN -	REVISED -			400	124 RS-7	LAKE	17	8	
PLOT SCALE = 50.0000' / 1" IN.		CHECKED -	REVISED -			SCALE: 1"=50' SHEET NO. 3 OF 3 SHEETS STA. 80+00 TO STA. 103+73					
PLOT DATE = 4/21/2009		DATE -	REVISED -			CONTRACT NO. 60H07 [ILLINOIS] FED. AID PROJECT					

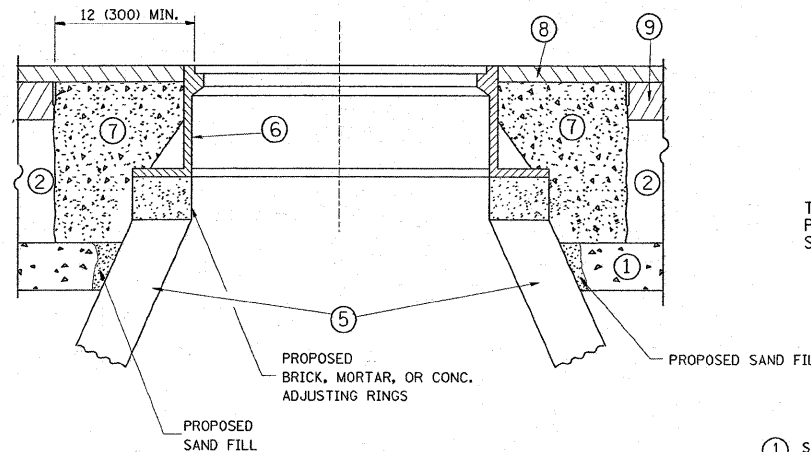
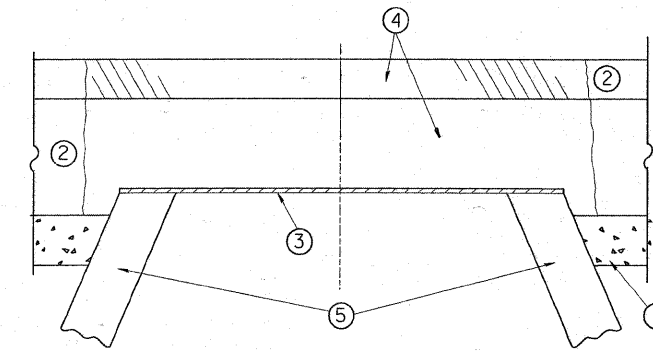

CONSTRUCTION PROCEDURES

STAGE 1 (BEFORE PAVEMENT MILLING)

- A) REMOVE A MINIMUM OF 12 (300) OF THE PAVEMENT FROM AROUND THE STRUCTURE.
- B) REMOVE THE EXISTING FRAME AND LID FROM THE STRUCTURE.
- C) COVER THE STRUCTURE OPENING WITH A 36 (900) DIAMETER METAL PLATE.
- D) BACKFILL WITH CRUSHED STONE AND A MINIMUM 1/2 (40) THICK HMA SURFACE MIX APPROVED BY THE ENGINEER.

STAGE 2 (AFTER PAVEMENT MILLING)

- A) REMOVE THE HMA SURFACE MIX AND CRUSHED STONE.
- B) INSTALL THE FRAME AND LID; ADJUST THE FRAME TO ITS FINAL SURFACE ELEVATION.
- C) THE SURROUNDING SPACE SHALL BE FILLED WITH CLASS SI CONCRETE, OR HMA SURFACE COURSE OR HMA BINDER COURSE TO THE ELEVATION OF THE SURFACE OF THE EXISTING BASE COURSE OR THE BINDER COURSE.

THE PROCEDURE EXPLAINED ABOVE SHALL CONFORM TO THE APPLICABLE PORTIONS OF SECTIONS 353, 406, 602, AND 603 OF THE STANDARD SPECIFICATIONS.

LEGEND

- ① SUB-BASE GRANULAR MATERIAL
- ② EXISTING PAVEMENT
- ③ 36 (900) DIAMETER METAL PLATE
- ④ PROPOSED CRUSHED STONE AND HMA SURFACE MIX
- ⑤ EXISTING STRUCTURE
- ⑥ FRAME AND LID (SEE NOTES)
- ⑦ CLASS SI CONCRETE, HMA SURFACE COURSE OR HMA BINDER COURSE
- ⑧ PROPOSED HMA SURFACE COURSE
- ⑨ PROPOSED HMA BINDER COURSE

NOTES:

EXISTING BROKEN FRAMES AND LIDS SHALL BE REMOVED AND DISPOSED OF BY THE CONTRACTOR AND SHALL BE REPLACED AS DIRECTED BY THE ENGINEER. REPLACEMENT FRAMES AND LIDS WILL BE PAID FOR IN ACCORDANCE WITH ARTICLE 109.04 OF THE STANDARD SPECIFICATIONS UNLESS A SEPARATE PAY ITEM HAS BEEN PROVIDED.

IF THE EXISTING LIDS ARE OPEN, THE FRAME WILL BE ADJUSTED TO THE ELEVATION OF THE MILLED PAVEMENT SURFACE PRIOR TO THE MILLING OPERATION. THE FRAME WILL NOT BE REMOVED AND COVERED BY THE METAL PLATE.

CITY OF CHICAGO CASTINGS ARE THE PROPERTY OF THE CITY AND THE CONTRACTOR SHALL NOTIFY THE CITY FOR REMOVAL AND DISPOSITION OF THE CASTINGS.

THE METAL PLATE USED TO COVER THE STRUCTURE SHALL REMAIN THE PROPERTY OF THE CONTRACTOR.

WHEN STRUCTURES ARE TO BE ADJUSTED OR RECONSTRUCTED, THE LOWERING AND RAISING OF THE FRAMES AND LIDS WILL NOT BE PAID FOR SEPARATELY BUT WILL BE INCLUDED IN THE COST OF THE CORRESPONDING PAY ITEM.

LOCATION OF STRUCTURES:

THE CONTRACTOR WILL BE REQUIRED TO KEEP A RECORD OF THE LOCATIONS OF THE BURIED STRUCTURES ACCORDING TO THE STATION AND DISTANCE LEFT OR RIGHT OF THE CENTERLINE OF PAVEMENT. UPON COMPLETION OF THE WORK, THE CONTRACTOR WILL DELIVER THE RECORD TO THE ENGINEER.

BASIS OF PAYMENT: THIS WORK WILL BE PAID FOR AT THE CONTRACT UNIT PRICE PER EACH FOR "FRAMES AND LIDS TO BE ADJUSTED, SPECIAL"

NEW FRAMES AND LIDS, WHEN SPECIFIED, WILL BE PAID FOR SEPARATELY.

DETAILS FOR FRAMES AND LIDS ADJUSTMENT WITH MILLING

ALL DIMENSIONS ARE IN INCHES (MILLIMETERS) UNLESS OTHERWISE SHOWN

FILE NAME =	USER NAME = hamdanah	DESIGNED - R. SHAH	REVISED - R. SHAH 03-10-95
at:\pw_work\APWID01\HAMDANAH\d0137088\Std.dgn		DRAWN -	REVISED - A. ABBAS 03-21-97
	PLOT SCALE = 50,0000 ' / IN.	CHECKED -	REVISED - R. WIEDEMAN 05-14-04
	PLOT DATE = 4/20/2009	DATE - 10-25-94	REVISED - R. BORO 01-01-07

**STATE OF ILLINOIS
DEPARTMENT OF TRANSPORTATION**

**DETAILS FOR
FRAMES AND LIDS ADJUSTMENT WITH MILLING**

SCALE: NONE SHEET NO. 1 OF 1 SHEETS STA. TO STA.

F.A.P. RTE.	SECTION	COUNTY	TOTAL SHEETS	SHEET NO.
400	124 RS-7	LAKE	17	9
BD600-03 (BD-8)			CONTRACT NO. 60H07	
FED. ROAD DIST. NO. 1 ILLINOIS FED. AID PROJECT				

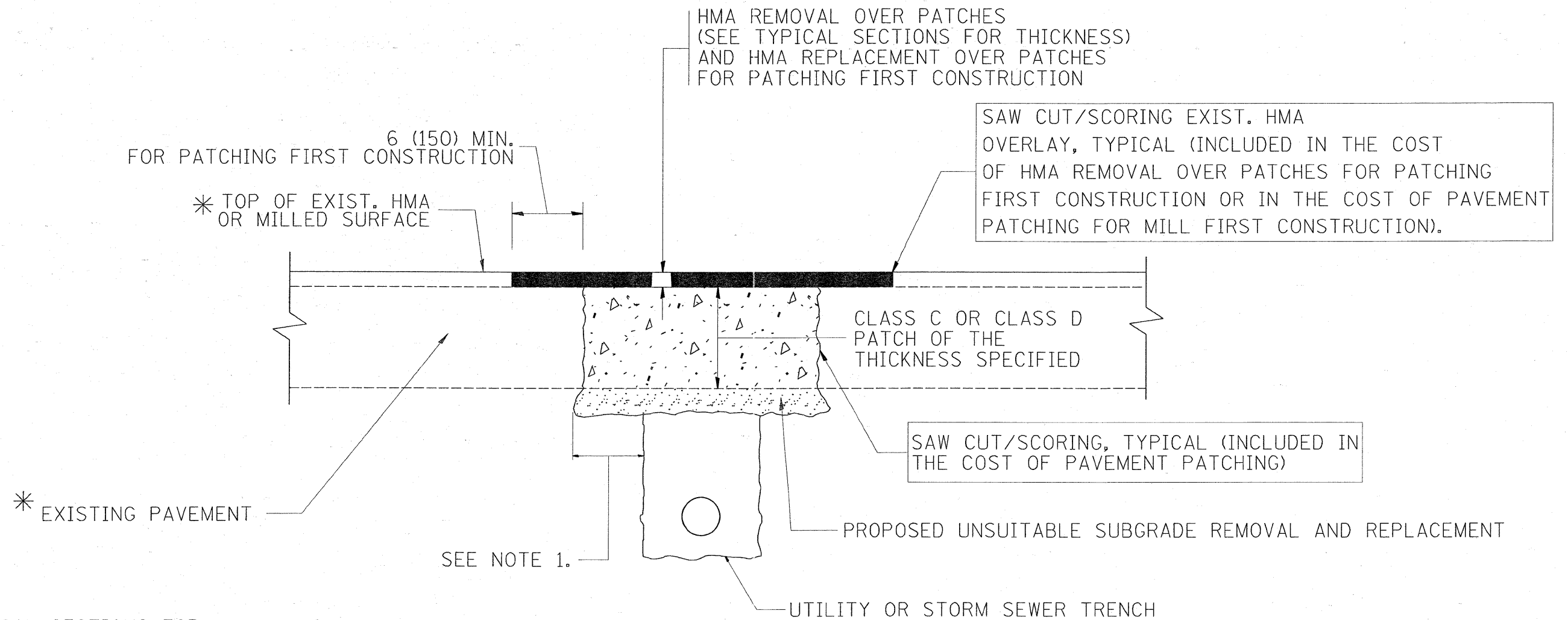

* SEE TYPICAL SECTIONS FOR THICKNESS AND MATERIALS

NOTES:

1. THE WIDTH OF THE FULL DEPTH PATCH OVER A TRENCH SHALL BE 12 (300) WIDER ON EACH SIDE OF THE TRENCH.
2. FOR METHOD OF MEASUREMENT AND BASIS OF PAYMENT, SEE RECURRING SPECIAL PROVISION "PATCHING WITH HOT-MIX ASPHALT OVERLAY REMOVAL".

SEQUENCE OF CONSTRUCTION (PATCHING FIRST)

1. REMOVE THE EXISTING HMA MATERIAL OVER THE AREA TO BE PATCHED.
2. REMOVE AND REPLACE WITH CLASS C OR D PATCH.
3. REPLACE HMA MATERIAL OVER THE AREA TO BE PATCHED.

SEQUENCE OF CONSTRUCTION (MILLING FIRST)

1. MILL HMA FIRST IF THERE IS AT LEAST 4 1/2 INCHES OR MORE OF HMA MATERIAL ON TOP OF THE EXISTING PAVEMENT OR IF THE PAVEMENT IS FULL DEPTH HMA. A MINIMUM OF 2 INCHES OF HMA MATERIAL SHALL BE IN PLACE AFTER MILLING.
2. REMOVE AND REPLACE WITH FULL DEPTH CLASS D PATCHES TO TOP OF MILLED SURFACE.

ALL DIMENSIONS ARE IN INCHES (MILLIMETERS) UNLESS OTHERWISE SHOWN.

FILE NAME =	USER NAME = hamdanah	DESIGNED - R. SHAH	REVISED - A. ABBAS 04-27-98	STATE OF ILLINOIS DEPARTMENT OF TRANSPORTATION	PAVEMENT PATCHING FOR HMA SURFACED PAVEMENT			F.A.P. RTE.	SECTION	COUNTY	TOTAL SHEETS	SHEET NO.
cs:\pwr\work\NPWIDOT\HAMDANAH\102137088\102137088.dgn	DRAWN -	REVISED - R. BORO 01-01-07	400					124 RS-7	LAKE	17	10	
PLOT SCALE = 50.0000' / IN.	CHECKED -	REVISED - R. BORO 09-04-07	BD400-04 (BD-22)			CONTRACT NO. 60H07						
PLOT DATE = 4/20/2009	DATE - 10-25-94	REVISED - K. ENG 10-27-08	SCALE: NONE		SHEET NO. 1 OF 1 SHEETS	STA.	TO STA.	FED. ROAD DIST. NO. 1 ILLINOIS FED. AID PROJECT				

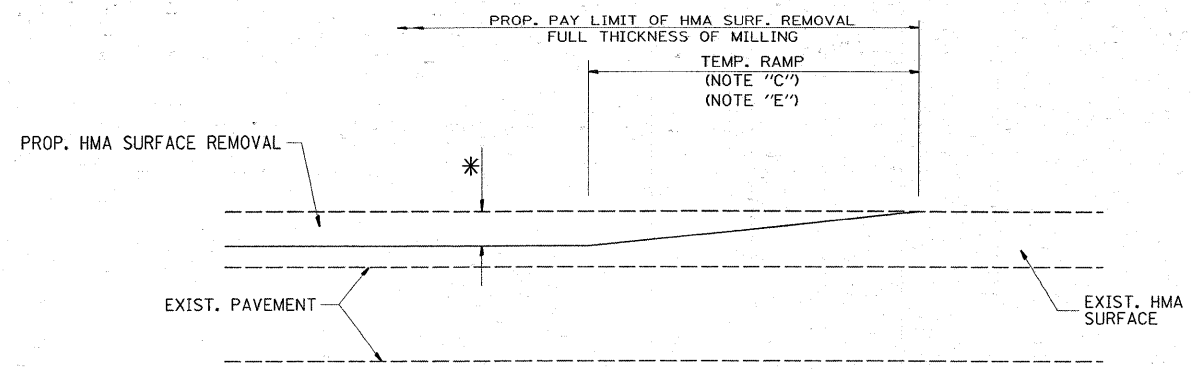

MILLED TEMPORARY RAMP
(FOR BUTT JOINT AND HMA TAPER SEE DETAIL BELOW)

OPTION 1

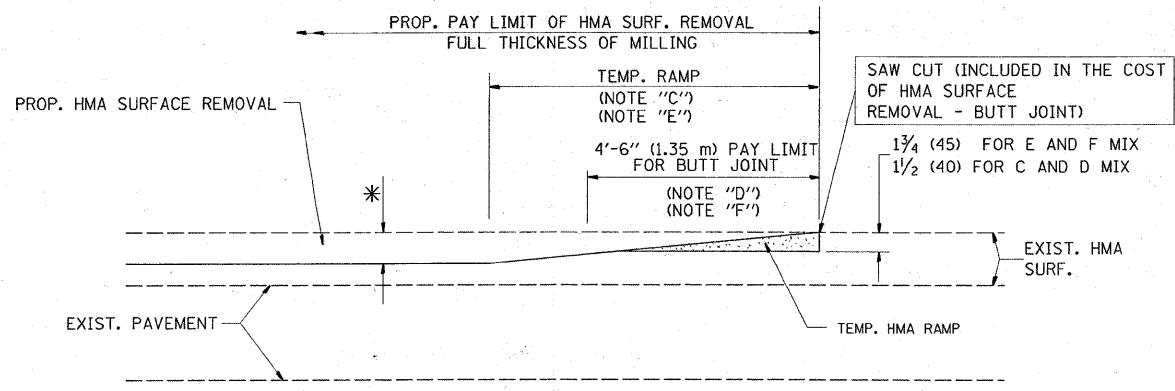

HMA CONSTRUCTED TEMPORARY RAMP
(FOR BUTT JOINT AND HMA TAPER SEE DETAIL BELOW)

OPTION 2

TYPICAL TEMPORARY RAMP

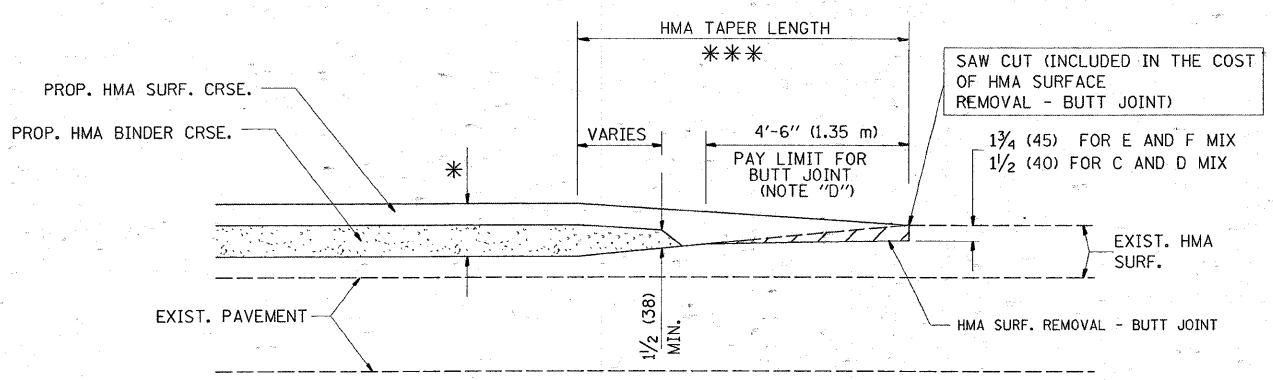

BUTT JOINT AND HMA TAPER

TYPICAL BUTT JOINT AND HMA TAPER
FOR MILLING AND RESURFACING

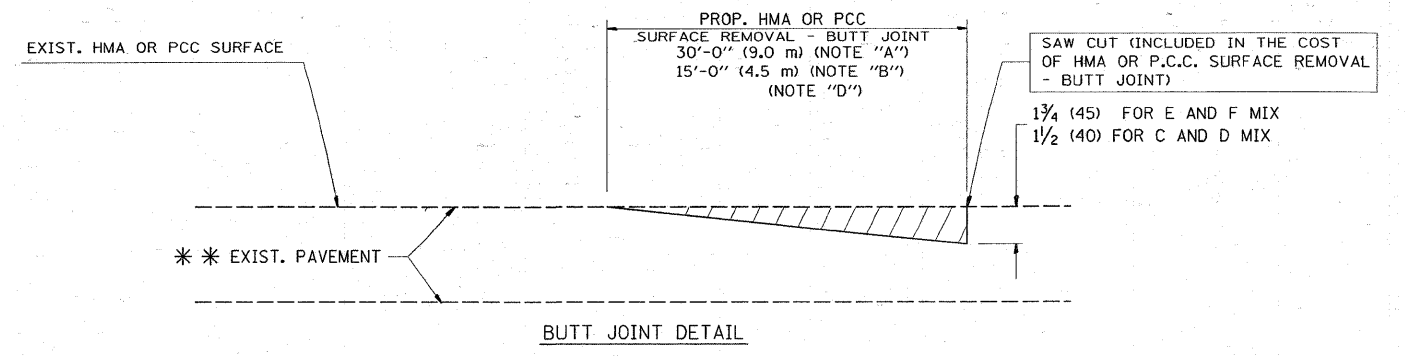

BUTT JOINT DETAIL

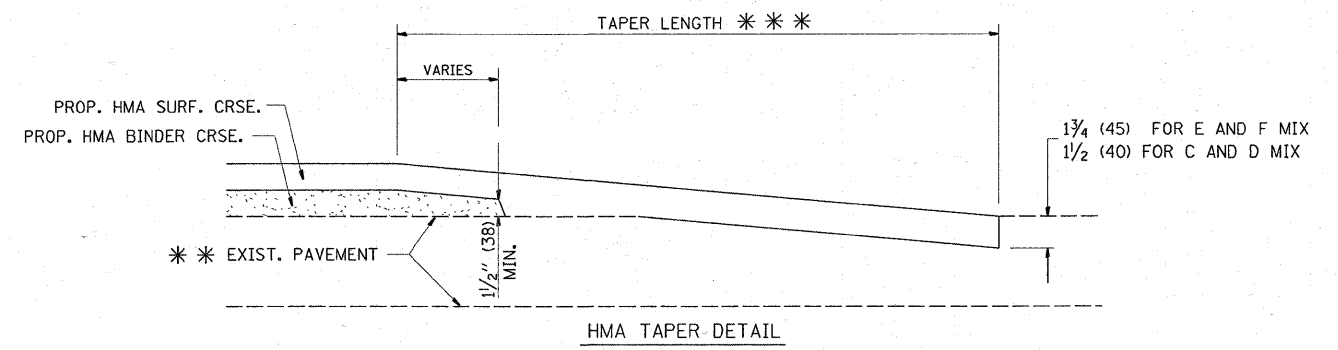

HMA TAPER DETAIL

TYPICAL BUTT JOINT AND HMA TAPER
FOR RESURFACING ONLY

*** PC CONCRETE, HMA OR HMA RESURFACED PAVEMENT.

NOTES

- A: MAINLINE ROADWAYS AND MAJOR SIDE ROADS.
 - B: MINOR SIDE ROADS.
 - C: THE TEMP. RAMP SHALL BE CONSTRUCTED IMMEDIATELY UPON REMOVAL OF THE EXISTING HMA SURFACE.
 - D: THE BUTT JOINT SHALL BE CONSTRUCTED IMMEDIATELY PRIOR TO PLACING THE PROPOSED HMA COURSES.
 - E: TAPER THE TEMP. RAMP AT A RATE OF 3'-0" (900 mm) PER 1 INCH (25 mm) OF MILLING THICKNESS.
 - F: INSTALLATION AND REMOVAL OF THE 4'-6" (1.35 m) TEMP. RAMP IS INCLUDED IN COST OF HMA SURFACE REMOVAL - BUTT JOINT
 - G: SEE ARTICLE 406.08 AND 406.14 OF THE STANDARD SPECIFICATIONS FOR "HMA AND/OR PCC SURFACE REMOVAL, BUTT JOINT".
- * SEE TYPICAL SECTIONS FOR MILLING THICKNESS.
- *** 20'-0" (6.1 m) PER 1 (25) RESURFACING (NOTE "A")
10'-0" (3.0 m) PER 1 (25) RESURFACING (NOTE "B")

BASIS OF PAYMENT:

THE BUTT JOINT WILL BE PAID FOR AT THE CONTRACT UNIT PRICE PER SQUARE YARD (SQUARE METER) FOR "HOT-MIX ASPHALT SURFACE REMOVAL - BUTT JOINT" OR FOR "PORTLAND CEMENT CONCRETE SURFACE REMOVAL - BUTT JOINT".

ALL DIMENSIONS ARE IN INCHES (MILLIMETERS) UNLESS OTHERWISE SHOWN.

FILE NAME =	USER NAME = hamdanah	DESIGNED - M. DE YONG	REVISED - R. SHAH 10-25-94
ct:\pwork\pwidot\HAMDANAH\d0137888\01	Std.dgn	DRAWN -	REVISED - A. ABBAS 03-21-97
	PLOT SCALE = 50.0000' / IN.	CHECKED -	REVISED - M. GOMEZ 04-06-01
	PLOT DATE = 4/20/2009	DATE - 06-13-90	REVISED - R. BORO 01-01-07

STATE OF ILLINOIS
DEPARTMENT OF TRANSPORTATION

BUTT JOINT AND HMA TAPER DETAILS			
SCALE: NONE	SHEET NO. 1 OF 1 SHEETS	STA.	TO STA.

F.A.P. RTE.	SECTION	COUNTY	TOTAL SHEETS	SHEET NO.
400	124 RS-7	LAKE	17	11
BD400-05 BD32		CONTRACT NO. 60H07		
FED. ROAD DIST. NO. 1 ILLINOIS FED. AID PROJECT				

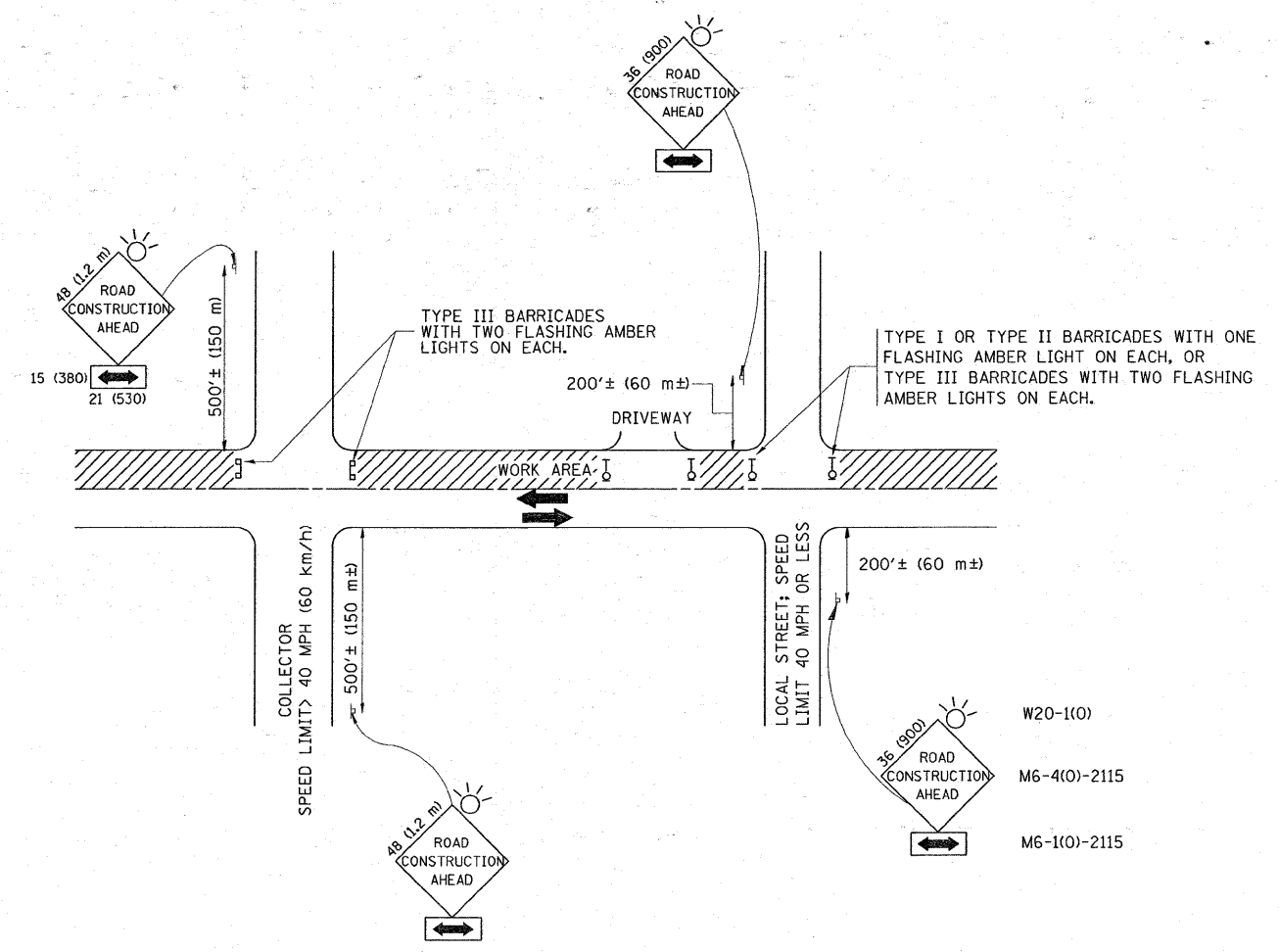

TRAFFIC CONTROL AND PROTECTION FOR SIDE ROADS, INTERSECTIONS, AND DRIVEWAYS

NOTES:

- A. FOR NO LANE RESTRICTION ON THE SIDE ROAD OR DRIVEWAYS
 1. SIDE ROAD WITH A SPEED LIMIT OF 40 MPH (60 km/h) OR LESS AS SHOWN ON THE DRAWING AND AS DIRECTED BY THE ENGINEER:
 - a) ONE ROAD CONSTRUCTION AHEAD SIGN 36 x 36 (900x900) WITH A FLASHER AND FLAG MOUNTED ON IT APPROXIMATELY 200' (60 m) IN ADVANCE OF THE MAIN ROUTE.
 - b) THE CLOSED PORTION OF THE MAIN ROUTE SHALL BE PROTECTED BY BLOCKING WITH TYPE I, TYPE II OR TYPE III BARRICADES, 1/3 OF THE CROSS SECTION OF THE CLOSED PORTION.
 2. SIDE ROAD WITH A SPEED LIMIT GREATER THAN 40 MPH (60 km/h) AS SHOWN ON THE DRAWING AND AS DIRECTED BY THE ENGINEER:
 - a) ONE ROAD CONSTRUCTION AHEAD SIGN 48 x 48 (1.2 m x 1.2 m) WITH A FLASHER MOUNTED ON IT APPROXIMATELY 500' (150 m) IN ADVANCE OF THE MAIN ROUTE.
 - b) THE CLOSED PORTION OF THE MAIN ROUTE SHALL BE PROTECTED BY BLOCKING WITH TYPE III BARRICADES, 1/2 OF THE CROSS SECTION OF THE CLOSED PORTION.
 3. WHEN THE SIDE ROAD LIES BETWEEN THE BEGINNING OF THE MAINLINE SIGNING AND THE WORK ZONE, A SINGLE HEADED ARROW (M6-1) SHALL BE USED IN LIEU OF THE DOUBLE HEADED ARROW (M6-4).
- B. FOR A LANE CLOSURE ON A SIDE ROAD OR DRIVEWAY:

USE APPLICABLE PORTIONS OF THE TYPICAL APPLICATION OF TRAFFIC CONTROL DEVICES (STD. 701501, STD. 701606 OR THE APPROPRIATE STANDARD). THE SPACING OF SIGNS AND BARRICADES SHALL BE ADJUSTED FOR FIELD CONDITIONS AS DIRECTED BY THE ENGINEER. THE DIRECTIONAL ARROW SHALL BE COVERED OR REMOVED WHEN NO LONGER CONSISTENT WITH THE SIDE ROAD LANE CLOSURE.

 - C. ADVANCE WARNING SIGNS ARE TO BE OMITTED ON DRIVEWAY UNLESS OTHERWISE NOTED.
 - D. THE TRAFFIC CONTROL AND PROTECTION FOR SIDE ROADS, INTERSECTIONS, AND DRIVEWAYS SHALL BE INCIDENTAL TO THE COST OF SPECIFIED TRAFFIC CONTROL STANDARDS OR ITEMS.

All dimensions are in millimeters (inches) unless otherwise shown.

FILE NAME =	USER NAME = hamdanah	DESIGNED - LHA	REVISED - J. OBERLE 10-18-95	STATE OF ILLINOIS DEPARTMENT OF TRANSPORTATION	TRAFFIC CONTROL AND PROTECTION FOR SIDE ROADS, INTERSECTIONS, AND DRIVEWAYS		F.A.P. RTE.	SECTION	COUNTY	TOTAL SHEETS	SHEET NO.	
\\pwwork\pwwid01\HAMDANAH\d0137088\Drawings\Std.dgn		DRAWN -	REVISED - A. HOUSEH 03-06-96		SCALE: NONE	SHEET NO. 1 OF 1 SHEETS	STA.	400	124 RS-7	LAKE	17	12
		CHECKED -	REVISED - A. HOUSEH 10-15-96					TC-10		CONTRACT NO. 60H07		
		DATE - 06-89	REVISED - T. RAMMACHER 01-06-00					FED. ROAD DIST. NO. 1 ILLINOIS FED. AID PROJECT				

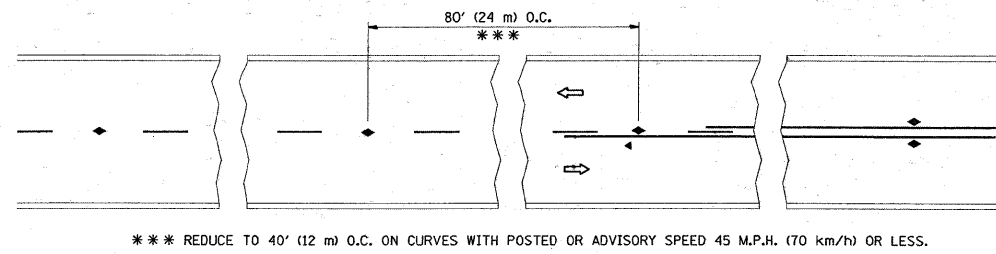

TWO-LANE/TWO-WAY

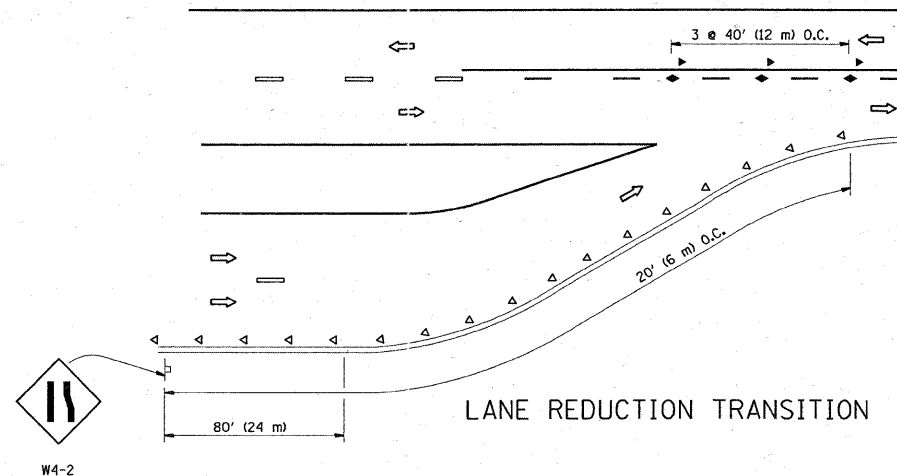

LANE REDUCTION TRANSITION

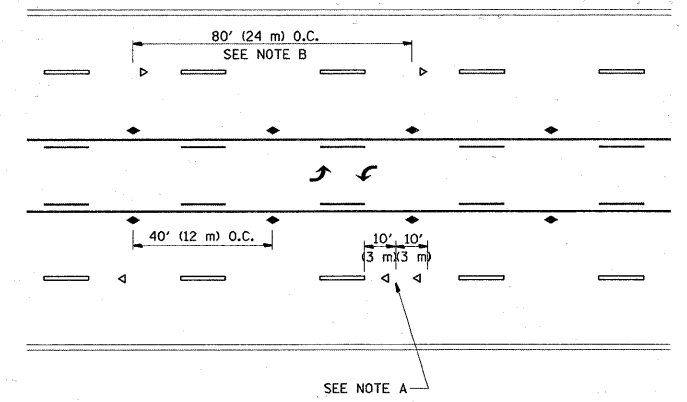

TWO-WAY LEFT TURN

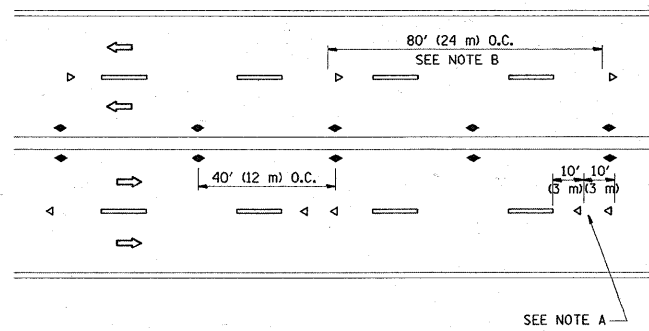

MULTI-LANE/UNDIVIDED

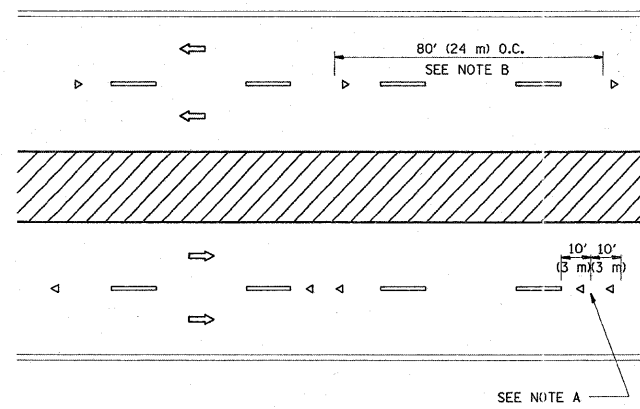

MULTI-LANE/DIVIDED

GENERAL NOTES

1. MARKERS USED WITH DASHED LINES SHALL BE CENTERED IN THE GAP BETWEEN SEGMENTS.
2. MARKERS USED ADJACENT TO SOLID LINES SHALL BE OFFSET 2 TO 3 (50 TO 75) TOWARD TRAFFIC AS SHOWN.
3. MARKERS THROUGH TANGENTS LESS THAN 500' (150 m) IN LENGTH BETWEEN CURVES SHALL BE INSTALLED AT THE LESSER OF THE TWO CURVE SPACINGS.

SYMBOLS

- YELLOW STRIPE
- WHITE STRIPE
- ◀ ONE-WAY AMBER MARKER
- ◀ ONE-WAY CRYSTAL MARKER (W/O)
- ◆ TWO-WAY AMBER MARKER

LANE MARKER NOTES

- B. REDUCE TO 40' (12 m) O.C. ON CURVES WHERE ADVISORY SPEEDS ARE 10 M.P.H (20 km/h) LOWER THAN POSTED SPEEDS.
- A. USE DOUBLE LANE LINE MARKERS SPACED AS SHOWN.

DESIGN NOTES

1. DOUBLE LANE LINE MARKERS SHALL BE USED UNLESS SPECIFIED OTHERWISE.
2. EXCEPT AS SHOWN ON THE LANE REDUCTION TRANSITION AND FREEWAY EXIT RAMP DETAIL, MARKERS ARE NOT TO BE SPECIFIED ON RIGHT EDGE LINES.
3. THE EXACT MARKER LIMITS, SPACING, AND COLOR SHOULD BE INCLUDED IN THE PLANS.
4. MARKERS SHOULD NOT BE USED ALONGSIDE CURBS EXCEPT FOR EXTREMELY SHORT SECTIONS OF CURBS WHERE NOT MORE THAN TWO MARKERS WOULD BE INVOLVED.

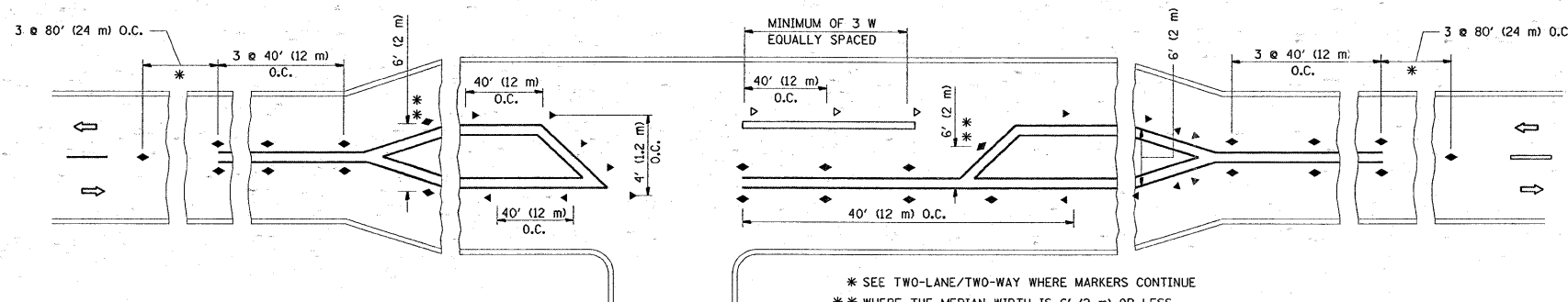

LEFT TURN

All dimensions are in inches (millimeters) unless otherwise shown.

FILE NAME =	USER NAME = hamdanah	DESIGNED -	REVISED - T. RAMMACHER 09-19-94
ct:\p\work\p\WIDOT\HAMDANAH\0137888\DI	Std.dgn	DRAWN -	REVISED - T. RAMMACHER 03-12-99
	PLOT SCALE = 50,0000' / IN.	CHECKED -	REVISED - T. RAMMACHER 01-06-00
	PLOT DATE = 4/20/2009	DATE -	REVISED -

STATE OF ILLINOIS
DEPARTMENT OF TRANSPORTATION

TYPICAL APPLICATIONS
RAISED REFLECTIVE PAVEMENT MARKERS (SNOW-PLOW RESISTANT)

SCALE: NONE SHEET NO. 1 OF 1 SHEETS STA. TO STA.

F.A.P. RTE.	SECTION	COUNTY	TOTAL SHEETS	SHEET NO.
400	124 RS-7	LAKE	17	13
TC-11		CONTRACT NO. 60H07		
FED. ROAD DIST. NO. 1 ILLINOIS FED. AID PROJECT				

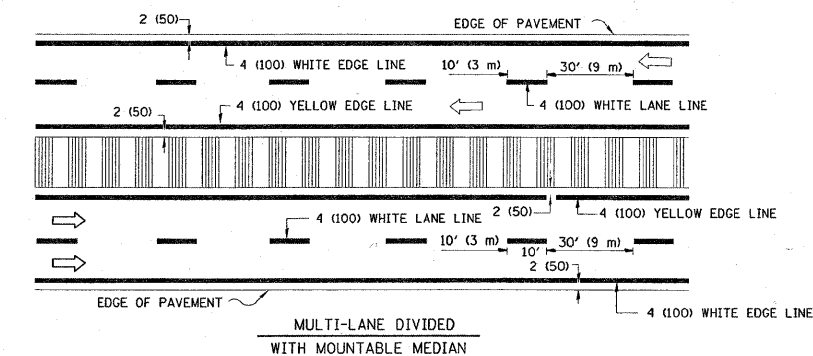
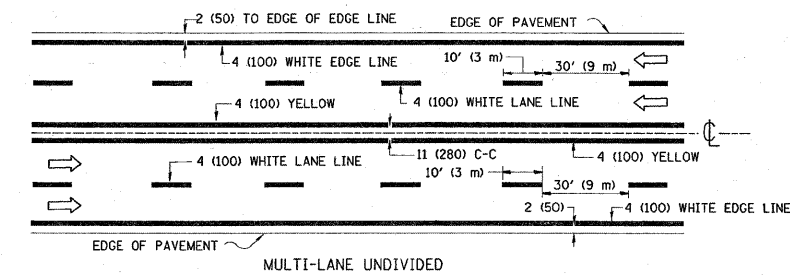
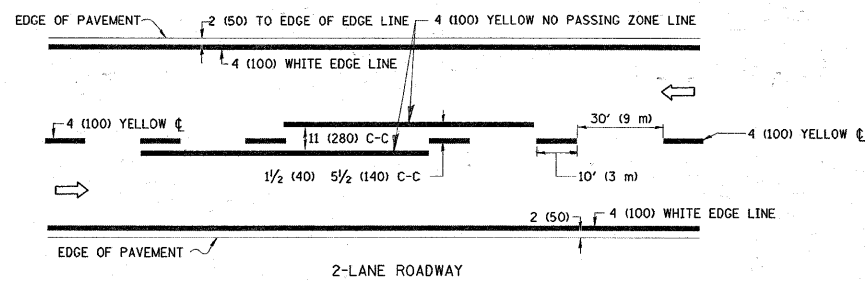

NOTE: MEDIANS WITH BARRIER CURB DO NOT REQUIRE AN EDGE LINE

TYPICAL LANE AND EDGE LINE MARKING

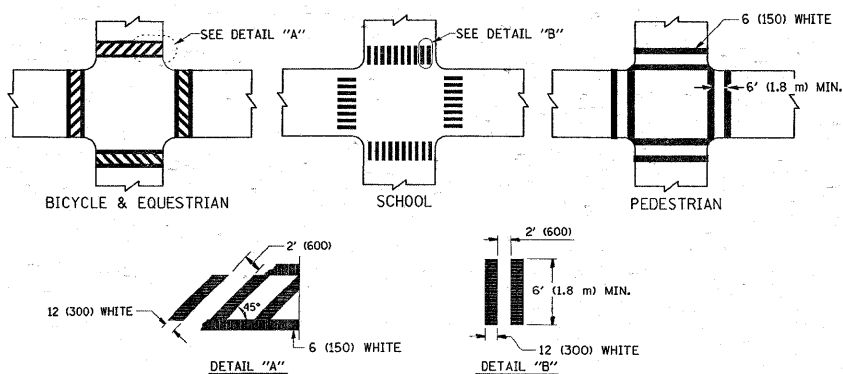

TYPICAL CROSSWALK MARKING

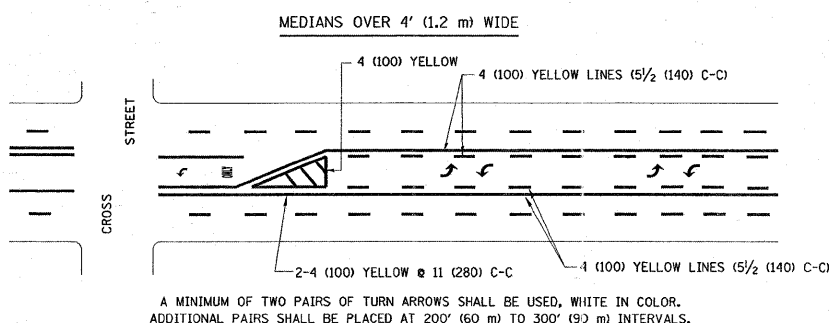
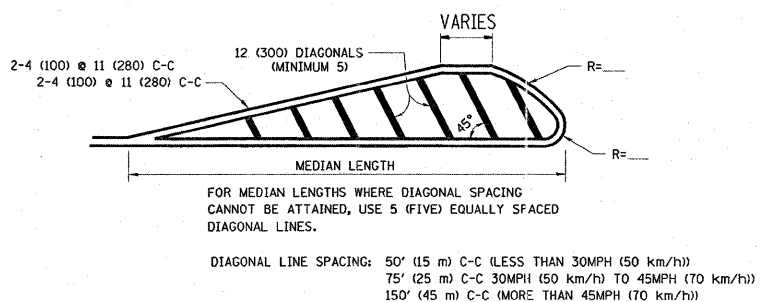
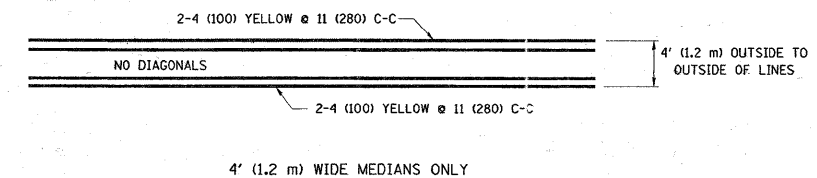

TYPICAL PAINTED MEDIAN MARKING

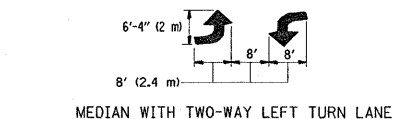

TYPICAL TURN LANE MARKING

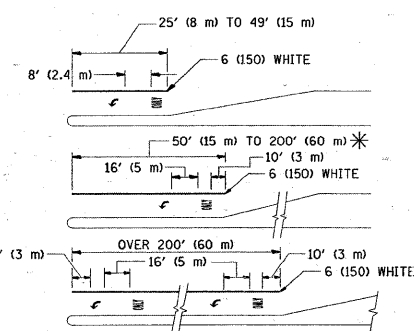

FULL SIZE LETTERS 8' (2.4 m) AND ARROWS SHALL BE USED.
 AREA = 15.6 SQ. FT. (1.5 m²) ONLY AREA = 20.8 SQ. FT. (1.9 m²)
 * TURN LANES IN EXCESS OF 400' (120 m) IN LENGTH MAY HAVE AN ADDITIONAL SET OF ARROW - "ONLY" INSTALLED MIDWAY BETWEEN THE OTHER TWO SETS OF ARROW - "ONLY".

TYPICAL LEFT (OR RIGHT) TURN LANE

TYPICAL TURN LANE MARKING

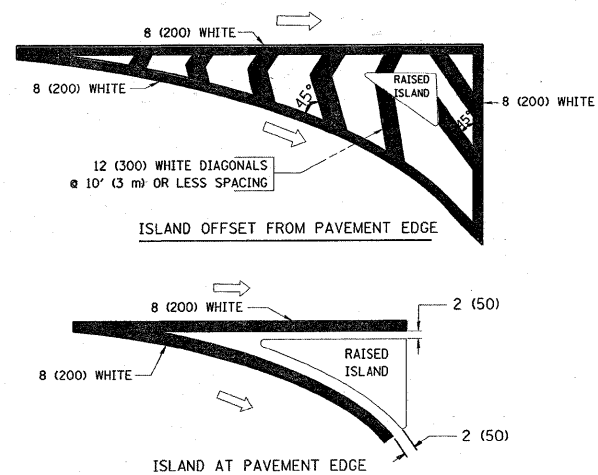

TYPICAL ISLAND MARKING

TYPE OF MARKING	WIDTH OF LINE	PATTERN	COLOR	SPACING / REMARKS
CENTERLINE ON 2 LANE PAVEMENT	4 (100)	SKIP-DASH	YELLOW	10' (3 m) LINE WITH 30' (9 m) SPACE
CENTERLINE ON MULTI-LANE UNDIVIDED PAVEMENT	2 @ 4 (100)	SOLID	YELLOW	11 (280) C-C
NO PASSING ZONE LINES: FOR ONE DIRECTION FOR BOTH DIRECTIONS	4 (100) 2 @ 4 (100)	SOLID SOLID	YELLOW YELLOW	5 1/2 (140) C-C FROM SKIP-DASH CENTERLINE 11 (280) C-C OMIT SKIP-DASH CENTERLINE BETWEEN
LANE LINES	4 (100) 5 (125) ON FREEWAYS	SKIP-DASH SKIP-DASH	WHITE WHITE	10' (3 m) LINE WITH 30' (9 m) SPACE
DOTTED LINES (EXTENSIONS OF CENTER, LANE OR TURN LANE MARKINGS)	SAME AS LINE BEING EXTENDED	SKIP-DASH	SAME AS LINE BEING EXTENDED	2' (600) LINE WITH 6' (1.8 m) SPACE
EDGE LINES	4 (100)	SOLID	YELLOW-LEFT WHITE-RIGHT	OUTLINE MOUNTABLE MEDIANS IN YELLOW; EDGE LINES ARE NOT USED NEXT TO BARRIER CURB
TURN LANE MARKINGS	6 (150) LINE; FULL SIZE LETTERS & SYMBOLS (8' (2.4m))	SOLID	WHITE	SEE TYPICAL TURN LANE MARKING DETAIL
TWO WAY LEFT TURN MARKING	2 @ 4 (100) EACH DIRECTION 8' (2.4m) LEFT ARROW	SKIP-DASH AND SOLID IN PAIRS	YELLOW WHITE	10' (3 m) LINE WITH 30' (9 m) SPACE FOR SKIP-DASH; 5 1/2 (140) C-C BETWEEN SOLID LINE AND SKIP-DASH LINE SEE TYPICAL TWO-WAY LEFT TURN MARKING DETAIL
CROSSWALK LINES (PEDESTRIAN) A. DIAGONALS (BIKE & EQUESTRIAN) B. LONGITUDINAL BARS (SCHOOL)	2 @ 6 (150) 12 (300) @ 45° 12 (300) @ 90°	SOLID SOLID SOLID	WHITE WHITE WHITE	NOT LESS THAN 6' (1.8 m) APART 2' (600) APART SEE TYPICAL CROSSWALK MARKING DETAILS.
STOP LINES	24 (600)	SOLID	WHITE	PLACE 4' (1.2 m) IN ADVANCE OF AND PARALLEL TO CROSSWALK, IF PRESENT. OTHERWISE, PLACE AT DESIRED STOPPING POINT, PARALLEL TO CROSSROAD CENTERLINE, WHERE POSSIBLE
PAINTED MEDIANS	2 @ 4 (100) WITH 12 (300) DIAGONALS @ 45° NO DIAGONALS USED FOR 4' (1.2 m) WIDE MEDIANS	SOLID	YELLOW; TWO WAY TRAFFIC WHITE; ONE WAY TRAFFIC	11 (280) C-C FOR THE DOUBLE LINE SEE TYPICAL PAINTED MEDIAN MARKING.
GORE MARKING AND CHANNELIZING LINES	8 (200) WITH 12 (300) DIAGONALS @ 45°	SOLID	WHITE	DIAGONALS: 15' (4.5 m) C-C (LESS THAN 30MPH (50 km/h)) 20' (6 m) C-C (30MPH (50 km/h) TO 45MPH (70 km/h)) 30' (9 m) C-C (OVER 45MPH (70 km/h))
RAILROAD CROSSING	24 (600) TRANSVERSE LINES; "RR" IS 6' (1.8 m) LETTERS; 16 (400) LINE FOR "X"	SOLID	WHITE	SEE STATE STANDARD 780001 AREA OF: "R"=3.6 SQ. FT. (0.33 m ²) EACH "X"=54.0 SQ. FT. (5.0 m ²)
SHOULDER DIAGONALS	12 (300) @ 45°	SOLID	WHITE - RIGHT YELLOW - LEFT	50' (15 m) C-C (LESS THAN 30MPH (50 km/h)) 75' (25 m) C-C (30 MPH (50 km/h) TO 45MPH (70 km/h)) 150' (45 m) C-C (OVER 45MPH (70 km/h))

FOR FURTHER DETAILS ON PAVEMENT MARKING REFER TO STANDARD SPECIFICATIONS FOR ROAD AND BRIDGE CONSTRUCTION AND STATE STANDARD 780001.

All dimensions are in inches (millimeters) unless otherwise shown.

FILE NAME =	USER NAME = hamdanah	DESIGNED - EVERS	REVISED - T. RAMMACHER 10-27-94
or:\pwwork\p\WID01\HAMDANAH\0137088\0137088.dgn	PLT SCALE = 5/8"=1' / IN.	DRAWN -	REVISED - A. HOUSEH 10-09-96
	PLT DATE = 4/28/2003	CHECKED -	REVISED - A. HOUSEH 10-17-96
		DATE - 03-19-90	REVISED - T. RAMMACHER 01-06-00

STATE OF ILLINOIS DEPARTMENT OF TRANSPORTATION

DISTRICT ONE TYPICAL PAVEMENT MARKINGS



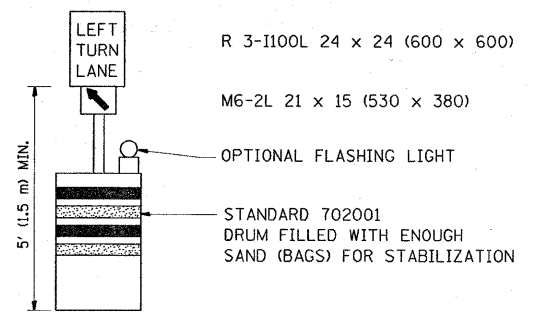
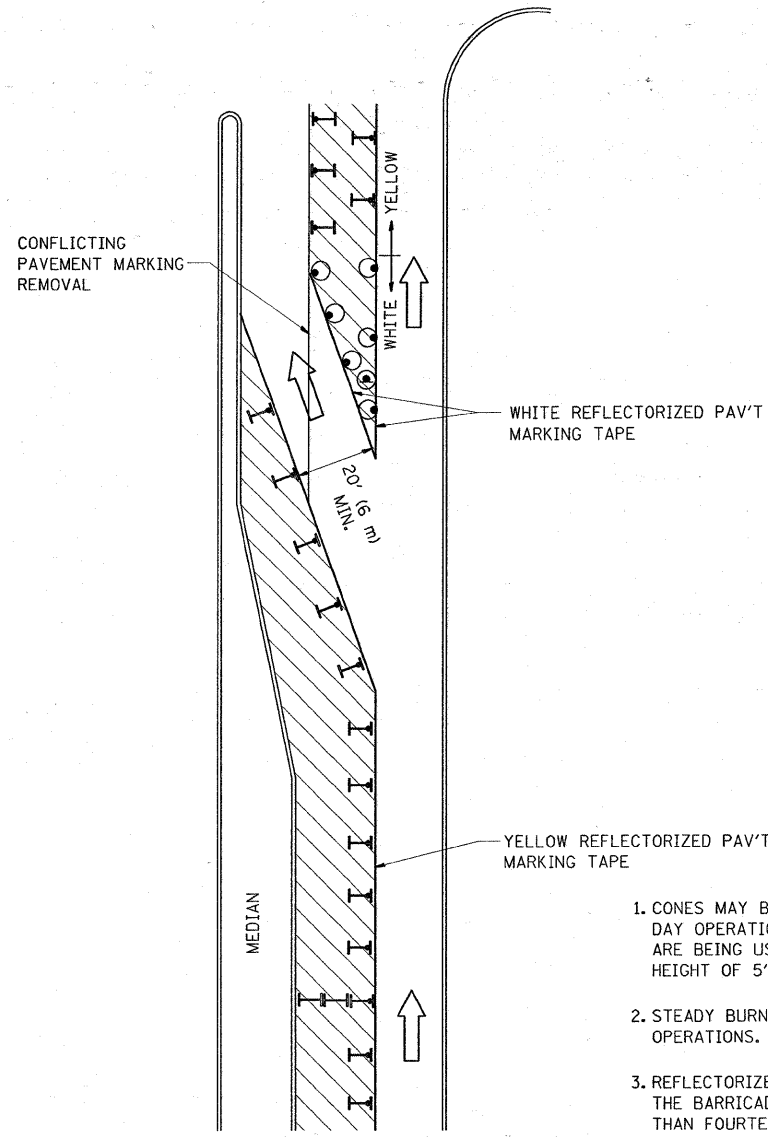



F.A.P. RTE. 400	SECTION 124 RS-7	COUNTY LAKE	TOTAL SHEETS 17	SHEET NO. 14
SCALE: NONE		SHEET NO. 1 OF 1 SHEETS		STA. TO STA.
FED. ROAD DIST. NO. 1		ILLINOIS		FED. AID PROJECT
		CONTRACT NO. 60H07		

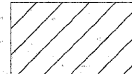

GENERAL NOTES

1. CONES MAY BE SUBSTITUTED FOR BARRICADES OR DRUMS AT HALF THE SPACING DURING DAY OPERATIONS. CONES SHALL BE A MINIMUM OF 28 (710) IN HEIGHT. WHEN CONES ARE BEING USED, THE "LEFT TURN LANE" SIGN MAY BE SKID MOUNTED AT A MINIMUM HEIGHT OF 5' (1.5 m).
2. STEADY BURNING LIGHTS WILL NOT BE REQUIRED ON BARRICADES OR DRUMS FOR DAY OPERATIONS. ALL LIGHTS SHALL BE MONODIRECTIONAL.
3. REFLECTORIZED TEMPORARY PAVEMENT MARKING TAPE SHALL BE PLACED THROUGHOUT THE BARRICADED AREA OF EACH TURN BAY WHERE THE CLOSURE TIME IS GREATER THAN FOURTEEN DAYS.
4. THIS APPLICATION ALSO APPLIES WHEN WORK IS BEING PERFORMED IN THE RIGHT LANE(S) AND THE RIGHT TURN BAY IS TO REMAIN OPEN. UNDER THIS CONDITION, "RIGHT TURN LANE" R3-100 24 x 24 (600 x 600) AND M6-2R 21 x 15 (530 x 380) SHALL BE USED.
5. THESE CONTROLS SHALL SUPPLEMENT MAINLINE TRAFFIC CONTROL FOR LANE CLOSURES.
6. LONGITUDINAL DIMENSIONS MAY BE ADJUSTED TO FIT FIELD CONDITIONS.
7. FORM BT 725 IS REQUIRED.
8. TRAFFIC CONTROL AND PROTECTION AT TURN BAYS (TO REMAIN OPEN TO TRAFFIC) SHALL BE INCLUDED IN THE COST SPECIFIED TRAFFIC CONTROL STANDARDS OR ITEMS.

LEGEND

-  WORK AREA
-  LANE OPEN TO TRAFFIC
-  TYPE I OR II BARRICADE WITH STEADY BURN LIGHT
-  DRUM WITH STEADY BURN LIGHT
-  DRUM WITH SIGN (WITH OPTIONAL FLASHING LIGHT) SEE DETAIL
-  TYPE I OR II CHECK BARRICADE WITH FLASHING LIGHT

All dimensions are in inches (millimeters) unless otherwise shown.

FILE NAME =	USER NAME = hamdanah	DESIGNED -	REVISED - T. RAMMACHER 09-08-94
ca:\pw\work\PW\DOT\HAMDANAH\0137888\Dis	Std.dgn	DRAWN -	REVISED - A. HOUSEH 11-07-95
		CHECKED -	REVISED - A. HOUSEH 10-12-96
		DATE -	REVISED - T. RAMMACHER 01-06-00

**STATE OF ILLINOIS
DEPARTMENT OF TRANSPORTATION**

**TRAFFIC CONTROL AND PROTECTION AT TURN BAYS
(TO REMAIN OPEN TO TRAFFIC)**

SCALE: NONE	SHEET NO. 1 OF 1 SHEETS	STA. TO STA.	F.A.P. RTE. 400	SECTION 124 RS-7	COUNTY LAKE	TOTAL SHEETS 17	SHEET NO. 15
			TC-14		CONTRACT NO. 60H07		
FED. ROAD DIST. NO. 1 (ILLINOIS) FED. AID PROJECT							

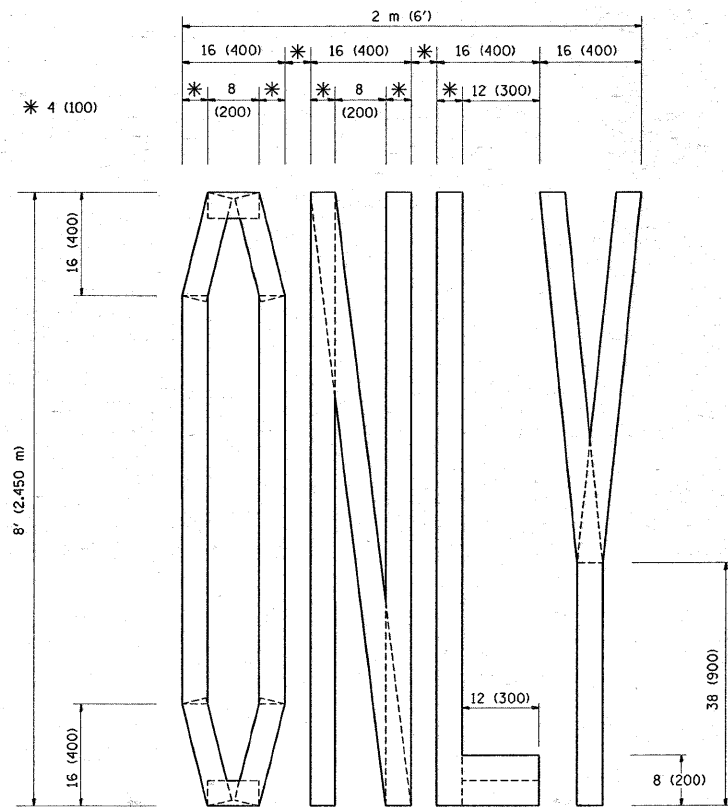

QUANTITY
 4 (100) LINE = 64.1 ft. (19.7 m)
 21.1 sq. ft. (1.97 sq. m)

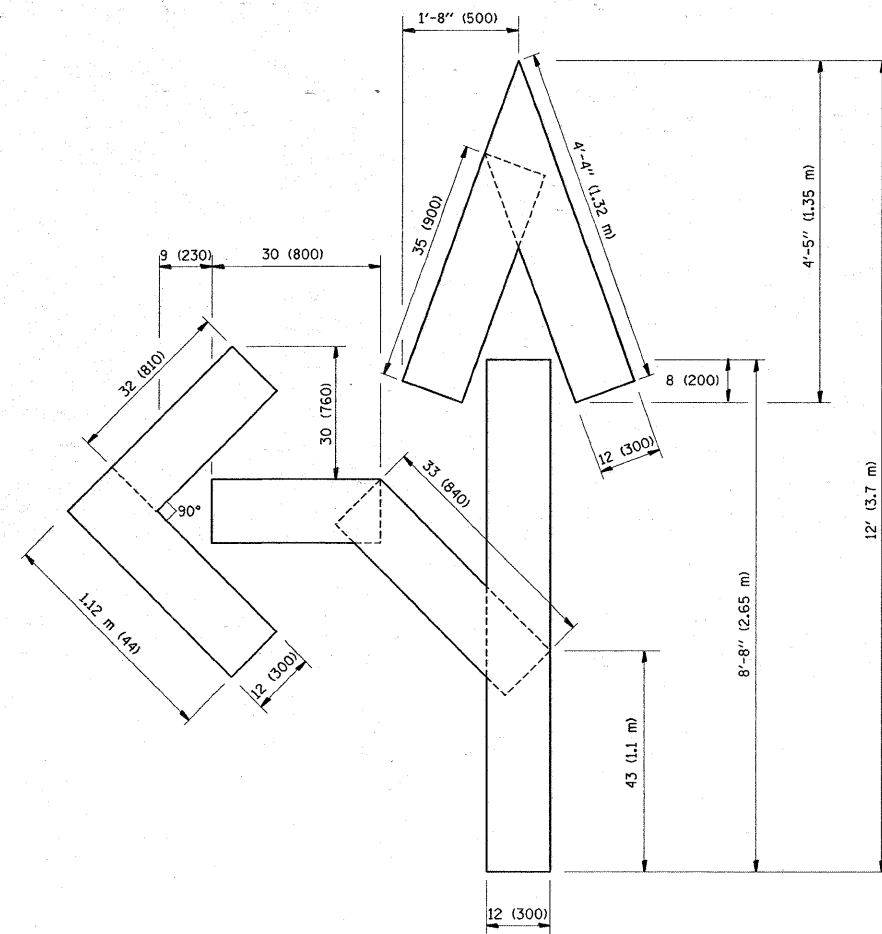

QUANTITY
 4 (100) LINE = 82.5 ft. (25.3 m)
 27.5 sq. ft. (2.53 sq. m)

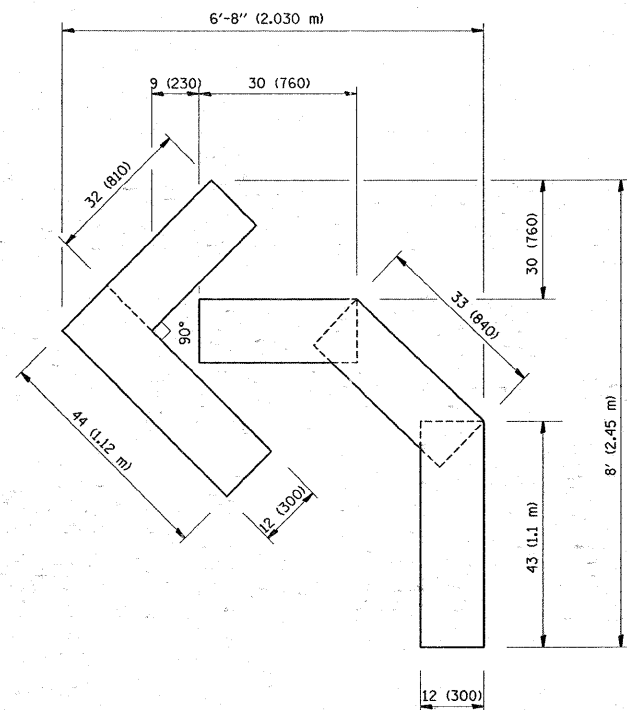

QUANTITY
 4 (100) LINE = 45.5 ft. (13.9 m)
 15.2 sq. ft. (1.39 sq. m)

All dimensions are in Inches (millimeters) unless otherwise shown.

FILE NAME =	USER NAME = hamdanah	DESIGNED -	REVISED -T. RAMMACHER 06-05-96
tes\pwr_work\p\WIDOT\HAMDNAH\0137088\Draw\Std.dgn		DRAWN -	REVISED -T. RAMMACHER 11-04-97
		CHECKED -	REVISED -T. RAMMACHER 03-02-98
		DATE - 09-18-94	REVISED -E. GOMEZ 08-28-00

STATE OF ILLINOIS
 DEPARTMENT OF TRANSPORTATION

PAVEMENT MARKING LETTERS AND SYMBOLS
 FOR TRAFFIC STAGING

SCALE: NONE SHEET NO. 1 OF 1 SHEETS STA. TO STA.

F.A.P. RTE.	SECTION	COUNTY	TOTAL SHEETS	SHEET NO.
400	124 RS-7	LAKE	17	16
TC-16			CONTRACT NO. 60H07	
FED. ROAD DIST. NO. 1 [ILLINOIS] FED. AID PROJECT				

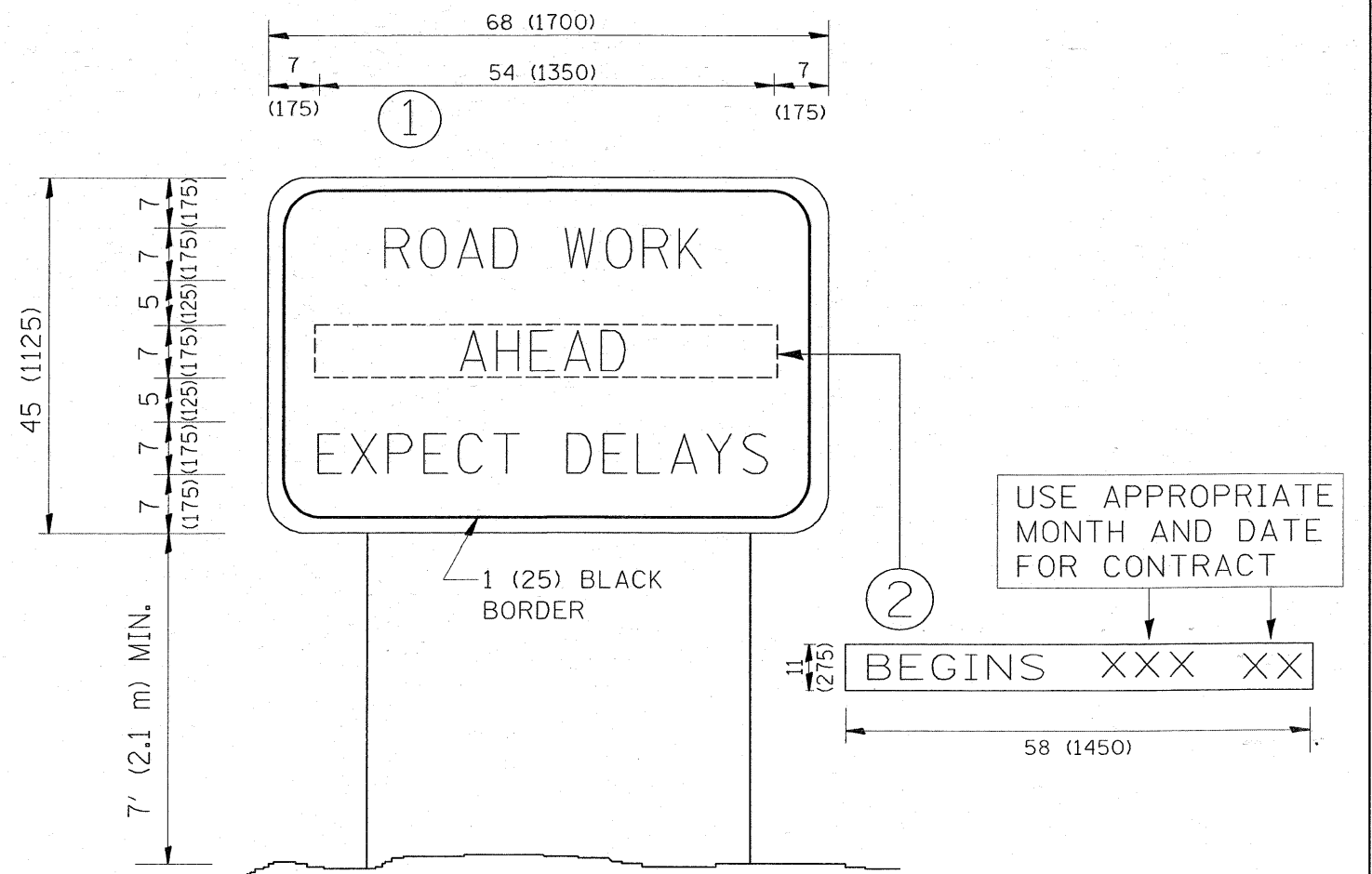

NOTES:

1. USE BLACK LETTERING ON ORANGE BACKGROUND.
2. ERECT SIGNS IN ADVANCE OF THE LOCATION FOR THE "ROAD CONSTRUCTION AHEAD" SIGN AT LOCATIONS AS DIRECTED BY THE ENGINEER.
3. ERECT SIGN ① WITH INSTALLED PANEL ② ONE WEEK PRIOR TO THE START OF CONSTRUCTION.
4. REMOVE PANEL ② SOON AFTER THE START OF CONSTRUCTION.
5. SEE SPECIAL PROVISION FOR "TEMPORARY INFORMATION SIGNING" FOR ADDITIONAL INFORMATION.
6. ONE SIGN ASSEMBLY EQUALS 25.70 SQ. FT. (2.3 SQ. M.)
7. SHALL BE PAID FOR AS TEMPORARY INFORMATION SIGNING.

ALL DIMENSIONS ARE IN INCHES (MILLIMETERS) UNLESS OTHERWISE SHOWN.

FILE NAME =	USER NAME = hamdenah	DESIGNED -	REVISED - R. MIRS 09-15-97
c:\pwork\PKWIDOT\HAMDANAH\0137888\0137888.dgn		DRAWN -	REVISED - R. MIRS 12-11-97
		CHECKED -	REVISED - T. RAMMACHER 02-02-99
		DATE -	REVISED - C. JUCIUS 01-31-07

**STATE OF ILLINOIS
DEPARTMENT OF TRANSPORTATION**

**ARTERIAL ROAD
INFORMATION SIGN**

F.A.P. RTE. 400	SECTION 124 RS-7	COUNTY LAKE	TOTAL SHEETS 17	SHEET NO. 17
TC-22			CONTRACT NO. 60H07	
SCALE: NONE	SHEET NO. 1 OF 1 SHEETS	STA. TO STA.	FED. ROAD DIST. NO. 1 ILLINOIS FED. AID PROJECT	