

CENTERLINE INTERSTATE OR MULTI-LANE TWO WAY DIVIDED HIGHWAY

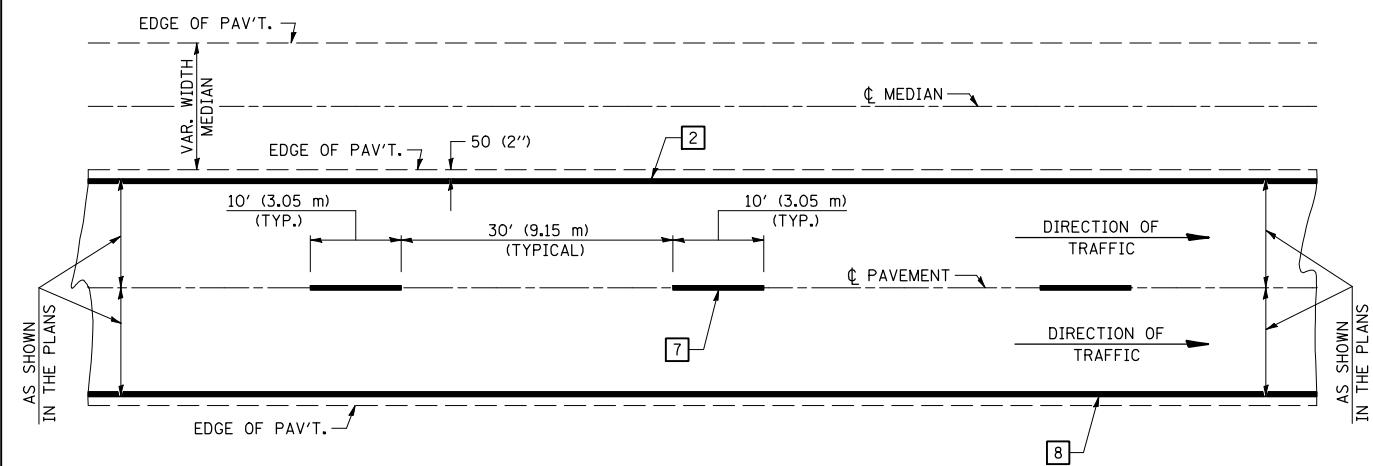

NOTE: PAVEMENT MARKINGS ARE TO BE EXTENDED THROUGH OMISSIONS WHEN APPLICABLE.

NOTE: SEE ARTICLES 780.04 & 781.03 FOR LOCATION OF STRIPES AND MARKERS RELATIVE TO EDGES OR JOINTS.
 FOR RAISED REFLECTIVE PAVEMENT MARKERS, REFER TO STANDARD 781001.

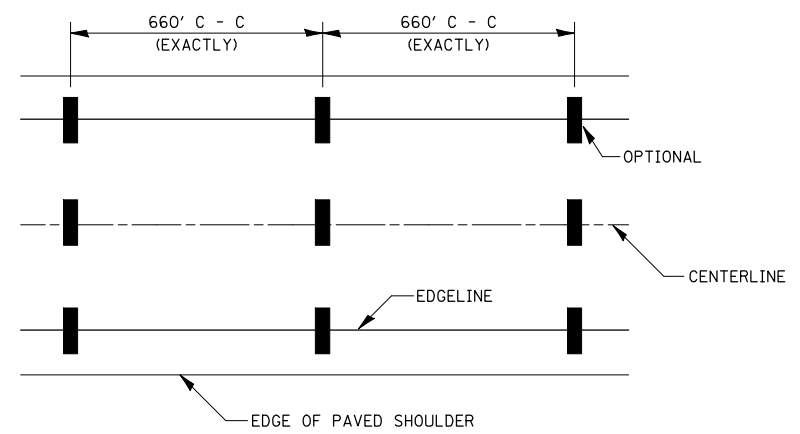

IT WILL BE NECESSARY TO HAVE A REPRESENTATIVE OF THE STATE POLICE PRESENT SO THAT THE ACCURACY OF MEASUREMENT CAN BE ATTESTED TO IN COURT.

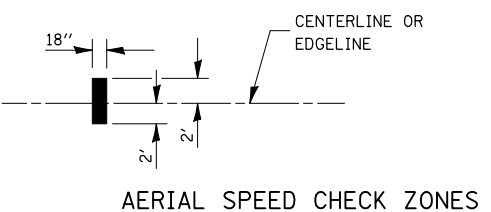

AERIAL SPEED CHECK ZONES

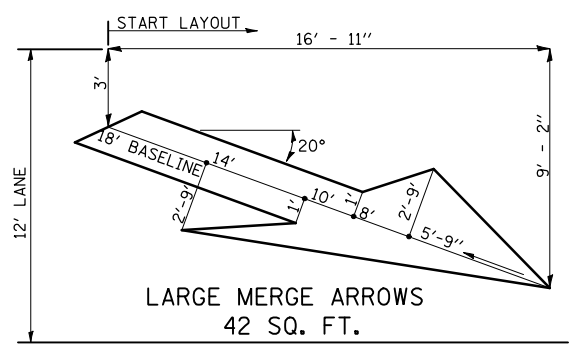

TYPICAL PAVEMENT MARKING LEGEND

- 1 4" (100) SKIP-DASH (YELLOW)
 - 2 4" (100) SOLID (YELLOW)
 - 3 12" (300) DIAGONAL (YELLOW)
 - 4 4" (100) DOUBLE YELLOW (NARROW)
 - 5 RESERVED
 - 6 RESERVED
 - 7 4" (100) SKIP-DASH (WHITE)
 - 8 4" (100) SOLID (WHITE)
 - 9 12" (300) DIAGONAL (WHITE)
 - 10 6" (150) SOLID (WHITE)
 - 11 24" (600) STOP BAR (WHITE)
 - 12 8" (200) SOLID (WHITE)
 - 13 4" (100) LANE LINE EXTENSIONS (WHITE)
-
-
-
-
-
-

TYPICAL EXIT RAMP TERMINAL

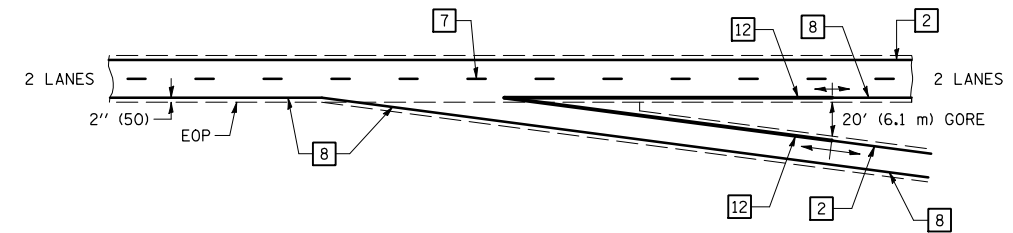

EXIT RAMP TERMINAL with EXCLUSIVE (auxiliary) LANE

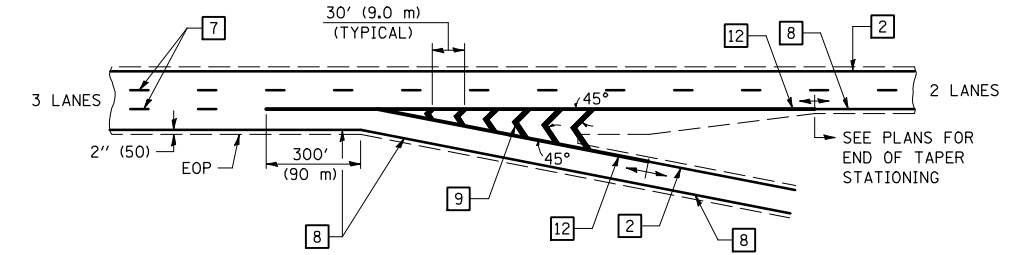

TYPICAL ENTRANCE RAMP TERMINAL

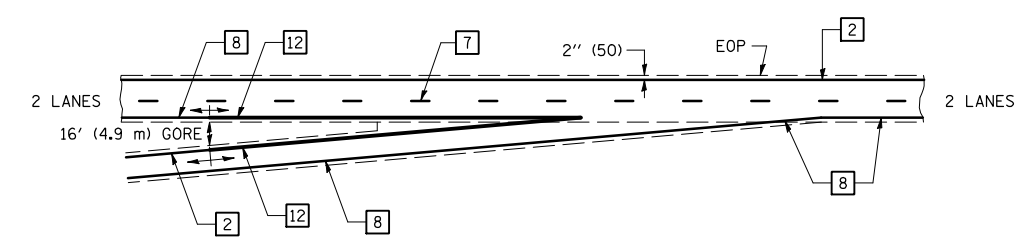

ENTRANCE RAMP TERMINAL with EXCLUSIVE LANE

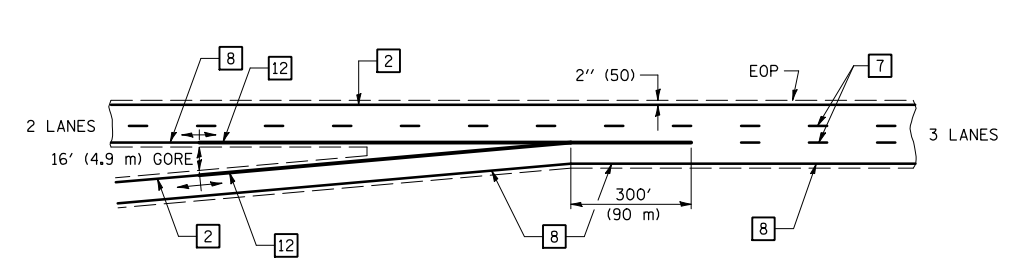

Note: All dimensions are in INCHES (millimeters) unless otherwise shown.

DATE	REVISIONS	NAME
11/06	REPLACED DETAIL F-5.22	TJB

ILLINOIS DEPARTMENT OF TRANSPORTATION
PAVEMENT MARKING
(INTERSTATE & MULTI-LANE APPLICATIONS)
DISTRICT 5 DETAIL NO. 7800BBBB