

ELEVATION

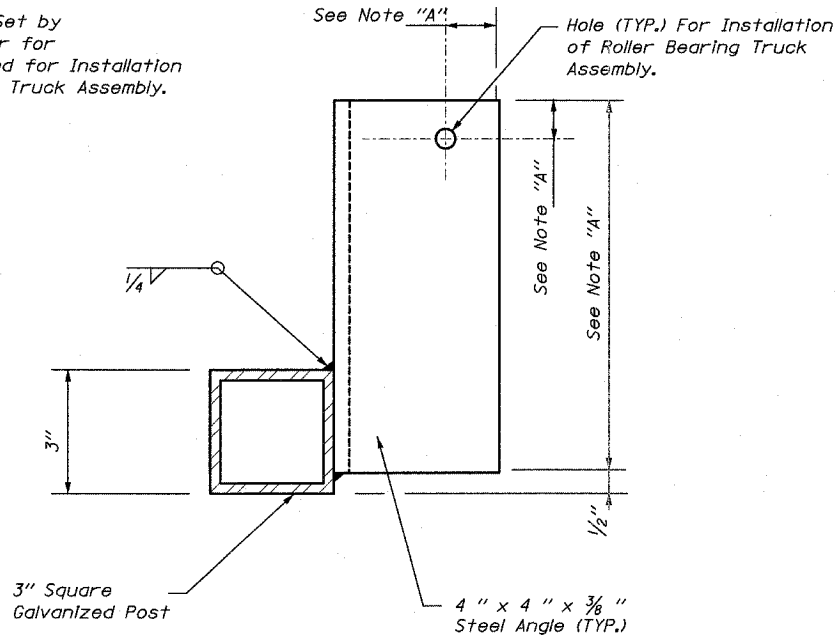

SECTION 4-4

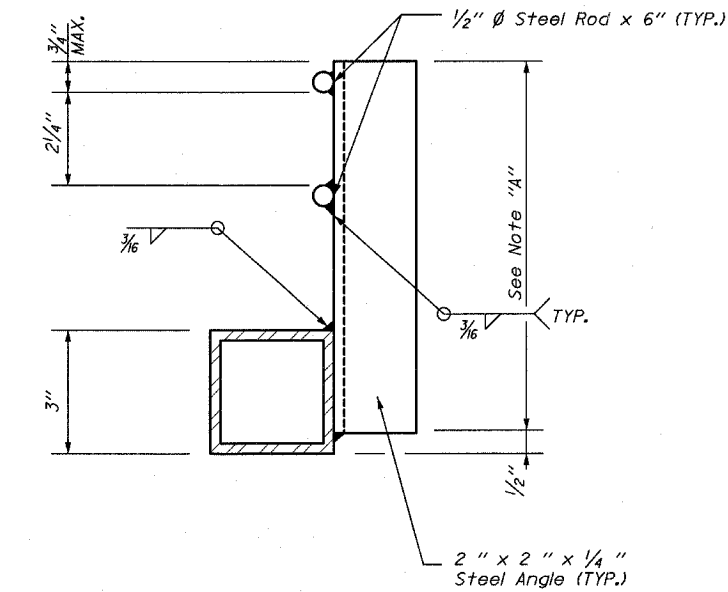

SECTION 5-5

DETAIL A

For Overhang Post - As Shown
For Gate Post "A" - Opposite Hand

NOTE "A": The Manufacturer of the Sliding Gate Shall Determine the Length of Angles and Location of Hole for Installation of Roller Bearing Truck Assembly.

NOTE: The Slide Gates Shall be of the Cantilevered Type with no Track or Support Across the Opening.

Edwards AND Kelcey
ONE NORTH FRANKLIN
CHICAGO, IL 60606
PHONE: (312) 251-3000
FAX: (312) 251-3015
WEB: WWW.EKCORP.COM

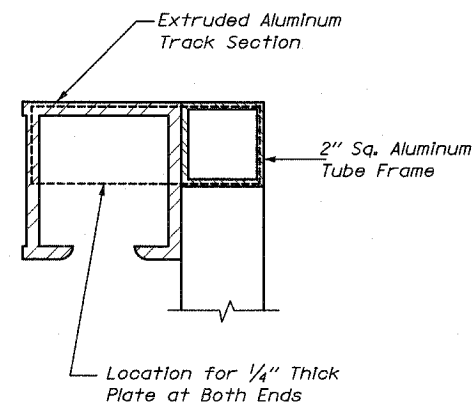

SECTION 8-8

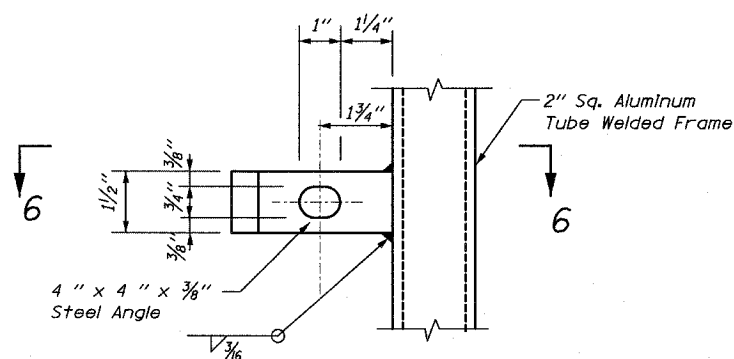

ELEVATION

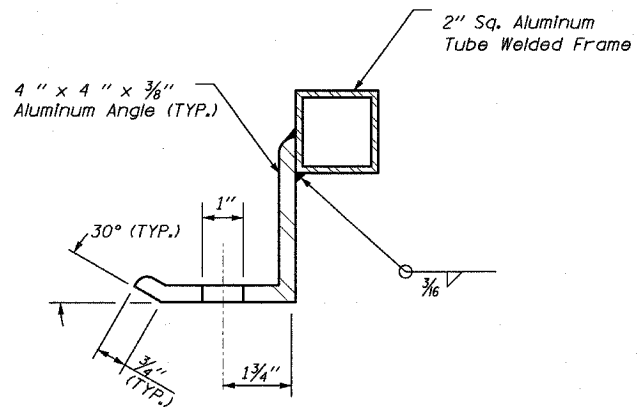

SECTION 6-6

DETAIL B

NOTE "B": The Manufacturer of the Sliding Gate Shall Set the Angle Based on the Size of the Track Frame

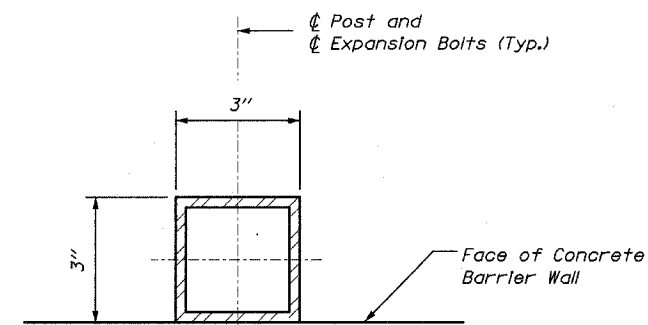

GATE AND OVERHANG POST SECTION

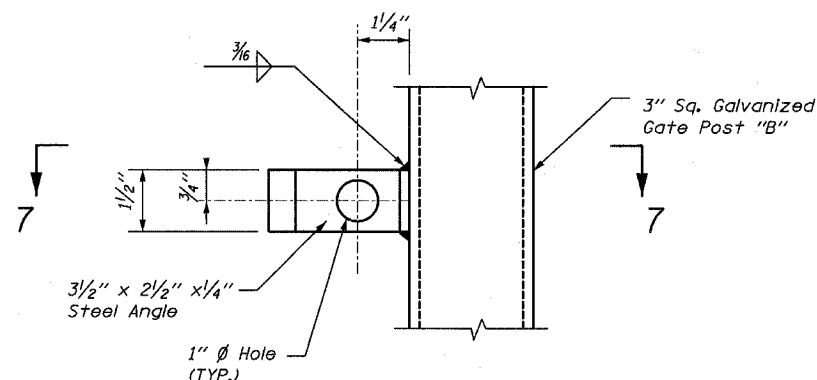

ELEVATION

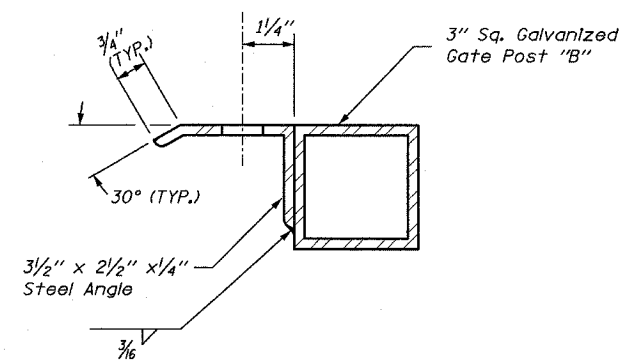

SECTION 7-7

DETAIL C

REVISIONS	
NAME	DATE

ILLINOIS DEPARTMENT OF TRANSPORTATION
F.A.I. 94 (DAN RYAN EXPRESSWAY)

CTA FENCE
ELEVATIONS AND DETAILS
SHEET 3 OF 3

SCALE: NONE
DATE: MARCH 1, 2006

DRAWN BY: RLK
CHECKED BY: EL