

\_\_\_ Sq. M. each  
 9.0 Sq. Ft. each  
 2 Required  
 Design Series D

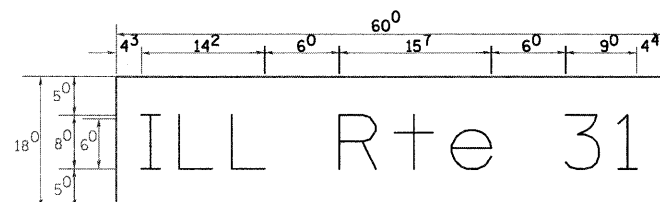

\_\_\_ Sq. M. each  
 7.5 Sq. Ft. each  
 1 Required  
 Design Series D

NOTE: SIGN DIMENSIONS ARE IN ENGLISH UNITS

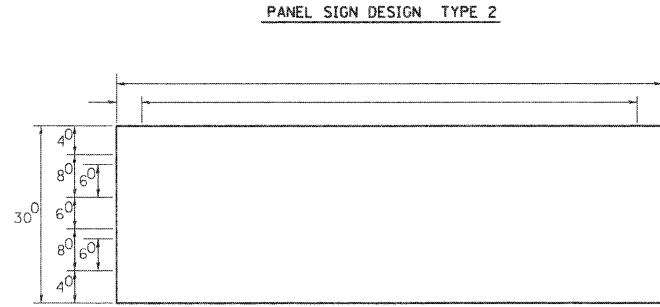

\_\_\_ Sq. M. each  
 \_\_\_ Sq. Ft. each  
 \_\_\_ Required  
 Design Series \_\_\_

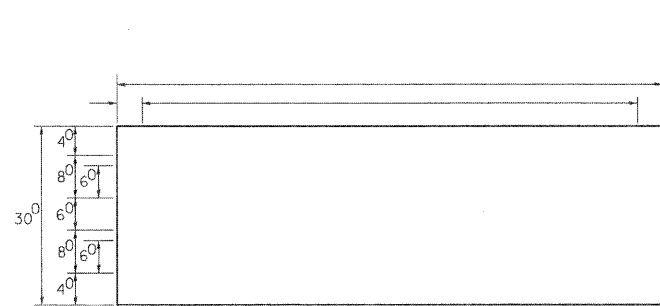

\_\_\_ Sq. M. each  
 \_\_\_ Sq. Ft. each  
 \_\_\_ Required  
 Design Series \_\_\_

GENERAL NOTES

- WHERE MAST ARM MOUNTED STREET NAME SIGNS ARE SPECIFIED, THE MAST ARM ASSEMBLY AND POLES SHALL BE DESIGNED TO SUPPORT THE LOADINGS CALLED FOR ON STANDARDS 834001, 834006 AND 834011, AS APPLICABLE, PLUS TWO (2) SIGN PANELS 2'-6" x 6'-0" MOUNTED AS SHOWN. THE DESIGN SHALL BE IN ACCORDANCE WITH THE REQUIREMENTS OF THE CURRENT "STANDARD SPECIFICATIONS FOR STRUCTURAL SUPPORTS FOR HIGHWAY SIGNS, LUMINAIRES, AND TRAFFIC SIGNALS" AS PUBLISHED BY THE AMERICAN ASSOCIATION OF STATE HIGHWAY AND TRANSPORTATION OFFICIALS FOR 80 M.P.H. WIND VELOCITY.
  - ALL SIGNS SHALL HAVE A WHITE REFLECTORIZED LEGEND AND BORDER ON A GREEN REFLECTORIZED BACKGROUND, TYPE A SHEETING.
  - THE SIGN LENGTH SHOULD BE INCREASED IN 6-INCH INCREMENTS, BUT THE OVERALL LENGTH SHOULD NOT EXCEED 6'-0".
  - ALL BORDERS SHALL BE 3/4" WIDE AND CORNER RADIUS SHALL BE 2-1/4".
  - SIGNFIX ALUMINUM CHANNEL FRAMING SYSTEM SHALL BE USED FOR ALL SIGNS ATTACHED TO SIGNAL POLES AND POSTS. LOCAL SUPPLIERS OF THE SIGNFIX ALUMINUM CHANNEL FRAMING SYSTEM ARE:
    - \* A.K.T. CORPORATION, SCHALMBURG, IL
    - \* TUCKER COMPANY, INC., WAUWATOSA, WI
    - \* AMERICAN FABRICATION CO., CHICAGO HEIGHTS, IL
    - \* WESTERN TRAFFIC CONTROL INC., CICERO, IL
- PARTS LISTING  
 SIGN CHANNEL PART \*HPN053 (MED. CHANNEL)  
 SIGN SCREWS 1/4" x 14 x 1" H.W.H. #3  
 BRACKETS SELF TAPPING WITH NEOPRENE WASHER  
 PART \*HPN034 (UNIVERSAL)  
 CHANNEL CLAMPS WITH STAINLESS STEEL STRAPPING  
 OTHER BRANDS OF MOUNTING HARDWARE ARE ACCEPTABLE, BASED UPON THE DEPARTMENT'S APPROVAL AND COMPATIBILITY WITH THE CHANNEL/BACKET OF THE ABOVE PRODUCT.

SUPPORTING CHANNELS

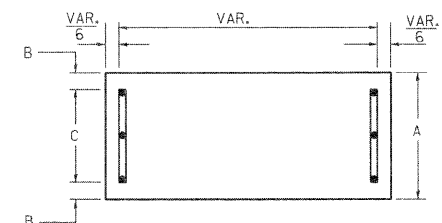

A	B	C
18"	2"	14"

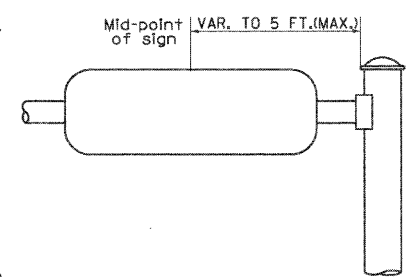

SUPPORTING CHANNELS

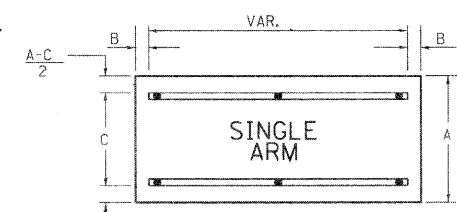

A	B	C
18"	2"	12"
30"	2"	22"

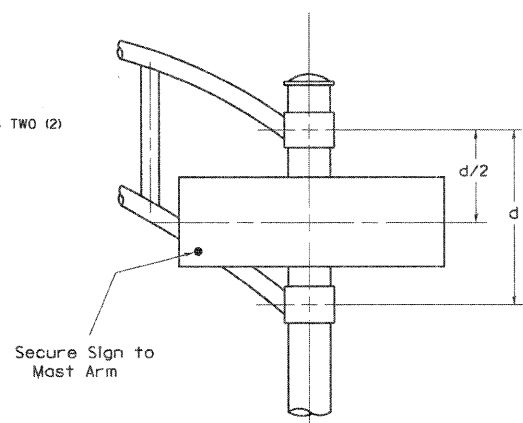

DUAL ARM

SIGNFIX ALUMINUM CHANNEL FRAMING SYSTEM Shall be used. See Note #5.

Upper Case to Lower Case Spacing Chart 8-6 Inch Series "C & D"

EXAMPLE, 2<sup>3</sup> DENOTES 3/8"

FIRST LETTER	SECOND LETTER																	
	ac		de		bh		kl		f w		j		s t		v y		x z	
	C	D	C	D	C	D	C	D	C	D	C	D	C	D	C	D	C	D
A W X	12	14	14	15	12	14	06	10	11	14	06	10	11	12	12	14	12	14
B	14	15	20	21	14	15	11	12	14	15	12	14	12	14	16	17	12	14
C E G	14	15	20	21	12	14	06	10	12	14	12	14	14	15	14	15	14	15
D O Q R	14	15	20	21	14	15	06	10	12	14	12	14	14	15	14	15	14	15
F	05	06	14	15	06	10	05	06	06	10	06	10	06	10	11	12	11	12
H I M N	20	21	22	24	20	21	14	15	16	17	16	17	20	21	20	21	20	21
J U	20	21	20	21	16	17	14	15	16	17	16	17	16	17	20	21	20	21
K L	11	12	16	17	11	12	05	06	11	12	11	12	11	12	12	14	12	14
P	12	14	14	15	12	14	05	06	11	12	11	12	12	14	12	14	12	14
S	12	14	16	17	12	14	06	10	12	14	12	14	12	14	12	14	12	14
T	11	12	16	17	06	10	06	10	11	12	11	12	11	12	12	14	12	14
V	06	10	14	15	11	12	06	10	12	14	12	14	12	14	12	14	12	14
Y	05	06	14	15	06	10	05	06	05	07	05	06	06	10	11	12	11	12
Z	16	17	22	24	16	17	12	14	16	17	16	17	16	17	20	21	20	21

Lower Case to Lower Case Spacing Chart 6 Inch Series "C & D"

FIRST LETTER	SECOND LETTER																	
	ac		de		bh		kl		f w		j		s t		v y		x z	
	C	D	C	D	C	D	C	D	C	D	C	D	C	D	C	D	C	D
a d h g i j	16	17	22	24	16	17	12	14	14	15	14	15	16	17	16	17	16	17
l m n q u	12	14	16	17	11	12	05	06	11	12	11	12	12	14	12	14	12	14
b f k o p s	12	14	16	17	12	14	06	10	12	14	12	14	12	14	12	14	12	14
c e	12	14	16	17	12	14	06	10	12	14	12	14	12	14	12	14	12	14
r	06	10	12	14	06	10	03	03	05	06	05	06	06	10	06	10	06	10
t z	12	14	16	17	12	14	06	10	11	12	11	12	12	14	12	14	12	14
v y	11	12	14	15	11	12	05	06	06	10	06	10	11	12	11	12	11	12
w	11	12	14	15	11	12	05	06	11	12	11	12	11	12	12	14	12	14
x	12	14	16	17	11	12	05	06	11	12	11	12	11	12	12	14	12	14

Number to Number Spacing Chart 8 Inch Series "C & D"

FIRST NUMBER	SECOND NUMBER																			
	0		1		2		3		4		5		6		7		8		9	
	C	D	C	D	C	D	C	D	C	D	C	D	C	D	C	D	C	D	C	D
0 9	16	17	16	17	14	15	12	14	14	15	14	15	16	17	12	14	16	17	16	17
1	20	21	20	21	20	21	16	17	14	15	20	21	20	21	14	15	20	21	20	21
2 3 4	14	15	14	15	14	15	12	14	14	15	14	15	11	12	16	17	14	15	14	15
5	14	15	14	15	14	15	11	12	11	12	14	15	14	15	11	12	14	15	14	15
6	16	17	14	15	14	15	12	14	14	15	14	15	11	12	14	15	14	15	14	15
7	12	14	12	14	14	15	12	14	15	12	14	14	15	11	12	14	15	12	14	14
8	16	17	16	17	14	15	12	14	14	15	16	17	12	14	16	17	14	15	14	15

UPPER AND LOWER CASE LETTER WIDTHS

LETTERS	6 INCH UPPER CASE LETTERS		8 INCH UPPER CASE LETTERS		LETTERS	6 INCH LOWER CASE LETTERS	
	SERIES		SERIES			SERIES	
	C	D	C	D		C	D
A	36	50	50	65	a	35	42
B	32	40	43	53	b	35	42
C	32	40	43	53	c	35	41
D	32	40	43	53	d	35	42
E	30	35	40	47	e	35	42
F	30	35	40	47	f	23	26
G	32	40	43	53	g	35	42
H	32	40	43	53	h	35	42
I	07	07	11	12	i	11	11
J	30	36	40	50	j	20	22
K	32	41	43	54	k	35	42
L	30	35	40	47	l	11	11
M	37	45	51	61	m	60	70
N	32	40	43	53	n	35	42
O	34	42	45	55	o	36	43
P	32	40	43	53	p	35	42
Q	34	42	45	55	q	35	42
R	32	40	43	53	r	26	32
S	32	40	43	53	s	36	42
T	30	35	40	47	t	27	32
U	32	40	43	53	u	35	42
V	35	44	47	60	v	42	47
W	44	52	60	70	w	55	64
X	34	40	45	53	x	44	51
Y	36	50	50	66	y	46	53
Z	32	40	43	53	z	36	43

NUMBER	6 INCH SERIES		8 INCH SERIES	
	C	D	C	D
1	12	14	15	20
2	32	40	43	53
3	32	40	43	53
4	35	43	47	57
5	32	40	43	53
6	32	40	43	53
7	32	40	43	53
8	32	40	43	53
9	32	40	43	53
0	34	42	45	55