

196

Letting June 12, 2026

Notice to Bidders, Specifications and Proposal



**Contract No. 99772
HAMILTON County
Section 23-00119-00-RS
Route FAS 882 (Blairsville Road)
Project GQHQ-960 ()
District 9 Construction Funds**

Plans Included
Herein

Prepared by

Checked by

F

(Printed by authority of the State of Illinois)



- 1. TIME AND PLACE OF OPENING BIDS.** Electronic bids are to be submitted to the electronic bidding system (iCX-Integrated Contractors Exchange). All bids must be submitted to the iCX system prior to 12:00 p.m. June 12, 2026 at which time the bids will be publicly opened from the iCX SecureVault.
- 2. DESCRIPTION OF WORK.** The proposed improvement is identified and advertised for bids in the Invitation for Bids as:

**Contract No. 99772
HAMILTON County
Section 23-00119-00-RS
Project GQHQ-960 ()
Route FAS 882 (Blairsville Road)
District 9 Construction Funds**

HMA resurfacing with aggregate shoulders and pavement marking on Blairsville Rd. from IL 242 to the White County Line in Hamilton County.

- 3. INSTRUCTIONS TO BIDDERS.** (a) This Notice, the invitation for bids, proposal and letter of award shall, together with all other documents in accordance with Article 101.09 of the Standard Specifications for Road and Bridge Construction, become part of the contract. Bidders are cautioned to read and examine carefully all documents, to make all required inspections, and to inquire or seek explanation of the same prior to submission of a bid.

(b) State law, and, if the work is to be paid wholly or in part with Federal-aid funds, Federal law requires the bidder to make various certifications as a part of the proposal and contract. By execution and submission of the proposal, the bidder makes the certification contained therein. A false or fraudulent certification shall, in addition to all other remedies provided by law, be a breach of contract and may result in termination of the contract.
- 4. AWARD CRITERIA AND REJECTION OF BIDS.** This contract will be awarded to the lowest responsive and responsible bidder considering conformity with the terms and conditions established by the Department in the rules, Invitation for Bids and contract documents. The issuance of plans and proposal forms for bidding based upon a prequalification rating shall not be the sole determinant of responsibility. The Department reserves the right to determine responsibility at the time of award, to reject any or all proposals, to re-advertise the proposed improvement, and to waive technicalities.

By Order of the
Illinois Department of Transportation

Gia Biagi,
Secretary

INDEX
FOR
SUPPLEMENTAL SPECIFICATIONS
AND RECURRING SPECIAL PROVISIONS

Adopted January 1, 2026

This index contains a listing of SUPPLEMENTAL SPECIFICATIONS, frequently used RECURRING SPECIAL PROVISIONS, and LOCAL ROADS AND STREETS RECURRING SPECIAL PROVISIONS.

ERRATA Standard Specifications for Road and Bridge Construction
(Adopted 1-1-22) (Revised 1-1-26)

SUPPLEMENTAL SPECIFICATIONS

<u>Std. Spec. Sec.</u>	<u>Page No.</u>
109 Measurement and Payment	1
202 Earth and Rock Excavation	2
204 Borrow and Furnished Excavation	3
207 Porous Granular Embankment	4
211 Topsoil and Compost	5
214 Grading and Shaping Ditches	6
406 Hot-Mix Asphalt Binder and Surface Course	7
407 Hot-Mix Asphalt Pavement (Full-Depth)	9
420 Portland Cement Concrete Pavement	10
502 Excavation for Structures	11
504 Precast Concrete Structures	12
509 Metal Railings	13
522 Retaining Walls	14
540 Box Culverts	15
542 Pipe Culverts	35
550 Storm Sewers	44
586 Granular Backfill for Structures	51
601 Pipe Drains, Pipe Underdrains, and French Drains	52
630 Steel Plate Beam Guardrail	53
632 Guardrail and Cable Road Guard Removal	54
644 High Tension Cable Median Barrier	55
665 Woven Wire Fence	56
701 Work Zone Traffic Control and Protection	57
781 Raised Reflective Pavement Markers	59
782 Reflectors	60
801 Electrical Requirements	62
821 Roadway Luminaires	65
1003 Fine Aggregates	66
1004 Coarse Aggregates	67
1010 Finely Divided Minerals	69
1020 Portland Cement Concrete	70
1030 Hot-Mix Asphalt	73
1040 Drain Pipe, Tile, and Wall Drain	74
1042 Precast Concrete Products	75
1061 Waterproofing Membrane System	76
1067 Luminaire	77
1097 Reflectors	84
1102 Hot-Mix Asphalt Equipment	85

RECURRING SPECIAL PROVISIONS

The following RECURRING SPECIAL PROVISIONS indicated by an "X" are applicable to this contract and are included by reference:

<u>CHECK SHEET #</u>		<u>PAGE NO.</u>
1	<input checked="" type="checkbox"/> Additional State Requirements for Federal-Aid Construction Contracts	87
2	<input checked="" type="checkbox"/> Subletting of Contracts (Federal-Aid Contracts)	90
3	<input checked="" type="checkbox"/> EEO	91
4	<input type="checkbox"/> Specific EEO Responsibilities Non Federal-Aid Contracts	101
5	<input type="checkbox"/> Required Provisions - State Contracts	106
6	<input type="checkbox"/> Asbestos Bearing Pad Removal	112
7	<input type="checkbox"/> Asbestos Waterproofing Membrane and Asbestos HMA Surface Removal	113
8	<input type="checkbox"/> Temporary Stream Crossings and In-Stream Work Pads	114
9	<input type="checkbox"/> Construction Layout Stakes	115
10	<input type="checkbox"/> Use of Geotextile Fabric for Railroad Crossing	118
11	<input type="checkbox"/> Subsealing of Concrete Pavements	120
12	<input type="checkbox"/> Hot-Mix Asphalt Surface Correction	124
13	<input type="checkbox"/> Pavement and Shoulder Resurfacing	126
14	<input type="checkbox"/> Patching with Hot-Mix Asphalt Overlay Removal	127
15	<input type="checkbox"/> Polymer Concrete	129
16	Reserved	131
17	<input type="checkbox"/> Bicycle Racks	132
18	<input type="checkbox"/> Temporary Portable Bridge Traffic Signals	134
19	<input type="checkbox"/> Nighttime Inspection of Roadway Lighting	136
20	<input type="checkbox"/> English Substitution of Metric Bolts	137
21	<input type="checkbox"/> Calcium Chloride Accelerator for Portland Cement Concrete	138
22	<input type="checkbox"/> Quality Control of Concrete Mixtures at the Plant	139
23	<input type="checkbox"/> Quality Control/Quality Assurance of Concrete Mixtures	147
24	Reserved	163
25	Reserved	164
26	<input type="checkbox"/> Temporary Raised Pavement Markers	165
27	<input type="checkbox"/> Restoring Bridge Approach Pavements Using High-Density Foam	166
28	<input type="checkbox"/> Portland Cement Concrete Inlay or Overlay	169
29	<input type="checkbox"/> Portland Cement Concrete Partial Depth Hot-Mix Asphalt Patching	173
30	<input type="checkbox"/> Longitudinal Joint and Crack Patching	176
31	<input type="checkbox"/> Concrete Mix Design – Department Provided	178
32	<input type="checkbox"/> Station Numbers in Pavements or Overlays	179

LOCAL ROADS AND STREETS RECURRING SPECIAL PROVISIONS

Table of Contents

<u>CHECK SHEET #</u>		<u>PAGE NO.</u>
LRS 1	Reserved	181
LRS 2	<input type="checkbox"/> Furnished Excavation	182
LRS 3	<input checked="" type="checkbox"/> Work Zone Traffic Control Surveillance	183
LRS 4	<input checked="" type="checkbox"/> Flaggers in Work Zones	184
LRS 5	<input type="checkbox"/> Contract Claims	185
LRS 6	<input type="checkbox"/> Bidding Requirements and Conditions for Contract Proposals	186
LRS 7	<input type="checkbox"/> Bidding Requirements and Conditions for Material Proposals	192
LRS 8	Reserved	198
LRS 9	<input type="checkbox"/> Bituminous Surface Treatments	199
LRS 10	Reserved	203
LRS 11	<input type="checkbox"/> Employment Practices	204
LRS 12	<input type="checkbox"/> Wages of Employees on Public Works	206
LRS 13	<input type="checkbox"/> Selection of Labor	208
LRS 14	<input type="checkbox"/> Paving Brick and Concrete Paver Pavements and Sidewalks	209
LRS 15	<input type="checkbox"/> Partial Payments	212
LRS 16	<input type="checkbox"/> Protests on Local Lettings	213
LRS 17	<input type="checkbox"/> Substance Abuse Prevention Program	214
LRS 18	<input type="checkbox"/> Multigrade Cold Mix Asphalt	215
LRS 19	<input type="checkbox"/> Reflective Crack Control Treatment	216

TABLE OF CONTENTS – SPECIAL PROVISIONS

<u>DESCRIPTION</u>	<u>PAGE #</u>
GENERAL	1
LOCATION OF WORK	1
DESCRIPTION OF WORK	1
TRAFFIC CONTROL AND PROTECTION, (SPECIAL)	1
UTILITIES	2
SIDE ROAD APPROACHES, COMMERCIAL ENTRANCES, PRIVATE ENTRANCES AND MAILBOX TURNOUTS	2
HMA SURFACE REMOVAL ½”	2
AGGREGATE SHOULDER, TYPE B	3
INSURANCE (LR 107-4)	4
LOCAL QUALITY ASSURANCE/QUALITY MANAGEMENT QC/QA	5

BDE SPECIAL PROVISIONS

The following special provisions indicated by an "X" are applicable to this contract. An * indicates a new or revised special provision for the letting.

<u>File Name</u>	<u>Pg.</u>	<input type="checkbox"/>	<u>Special Provision Title</u>	<u>Effective</u>	<u>Revised</u>
80099		<input type="checkbox"/>	Accessible Pedestrian Signals (APS)	April 1, 2003	Jan. 1, 2022
80274		<input type="checkbox"/>	Aggregate Subgrade Improvement	April 1, 2012	April 1, 2022
80192		<input type="checkbox"/>	Automated Flagger Assistance Device	Jan. 1, 2008	April 1, 2023
80173		<input type="checkbox"/>	Bituminous Materials Cost Adjustments	Nov. 2, 2006	Aug. 1, 2017
* 80426		<input type="checkbox"/>	Bituminous Surface Treatment with Fog Seal	Jan. 1, 2020	April 1, 2026
80475		<input type="checkbox"/>	Bridge Deck Concrete Overlays	Jan. 1, 2026	
80241		<input type="checkbox"/>	Bridge Demolition Debris	July 1, 2009	
50531		<input type="checkbox"/>	Building Removal	Sept. 1, 1990	Aug. 1, 2022
50261		<input type="checkbox"/>	Building Removal with Asbestos Abatement	Sept. 1, 1990	Aug. 1, 2022
80460	7	<input checked="" type="checkbox"/>	Cement, Finely Divided Minerals, Admixtures, Concrete, and Mortar	Jan. 1, 2025	Jan. 1, 2026
80384	24	<input checked="" type="checkbox"/>	Compensable Delay Costs	June 2, 2017	April 1, 2019
80198		<input type="checkbox"/>	Completion Date (via calendar days)	April 1, 2008	
80199		<input type="checkbox"/>	Completion Date (via calendar days) Plus Working Days	April 1, 2008	
80461		<input type="checkbox"/>	Concrete Barrier	Jan. 1, 2025	
80453		<input type="checkbox"/>	Concrete Sealer	Nov. 1, 2023	
80261		<input type="checkbox"/>	Construction Air Quality – Diesel Retrofit	June 1, 2010	Jan. 1, 2025
80476		<input type="checkbox"/>	Deck Slab Repair	Jan. 1, 2026	
80029		<input type="checkbox"/>	Disadvantaged Business Enterprise Participation	Sept. 1, 2000	Jan. 2, 2025
80467		<input type="checkbox"/>	Erosion Control Blanket	Aug. 1, 2025	
80229		<input type="checkbox"/>	Fuel Cost Adjustment	April 1, 2009	Aug. 1, 2017
80452		<input type="checkbox"/>	Full Lane Sealant Waterproofing System	Nov. 1, 2023	
80433		<input type="checkbox"/>	Green Preformed Thermoplastic Pavement Markings	Jan. 1, 2021	Jan. 1, 2022
80471		<input type="checkbox"/>	Guardrail	Nov. 1, 2025	
80472		<input type="checkbox"/>	High Friction Surface Treatment	Nov. 1, 2025	
* 80456	28	<input checked="" type="checkbox"/>	Hot-Mix Asphalt	Jan. 1, 2024	April 1, 2026
80446	32	<input checked="" type="checkbox"/>	Hot-Mix Asphalt – Longitudinal Joint Sealant	Nov. 1, 2022	Aug. 1, 2023
80438		<input type="checkbox"/>	Illinois Works Apprenticeship Initiative – State Funded Contracts	June 2, 2021	April 2, 2024
* 80483		<input type="checkbox"/>	Inlet Filters	April 1, 2026	
80477		<input type="checkbox"/>	Longitudinal Tining	Jan. 1, 2026	
80450		<input type="checkbox"/>	Mechanically Stabilized Earth Retaining Walls	Aug. 1, 2023	Aug. 1, 2025
80478		<input type="checkbox"/>	Modified Longitudinal Construction Joint	Jan. 1, 2026	
80464	34	<input checked="" type="checkbox"/>	Pavement Marking	April 1, 2025	Nov. 1, 2025
80468		<input type="checkbox"/>	Pavement Patching	Aug. 1, 2025	
* 80441	35	<input checked="" type="checkbox"/>	Performance Graded Asphalt Binder	Jan 1, 2023	April 1, 2026
80459		<input type="checkbox"/>	Preformed Plastic Pavement Marking	June 2, 2024	
34261		<input type="checkbox"/>	Railroad Protective Liability Insurance	Dec. 1, 1986	Jan. 1, 2022
80473		<input type="checkbox"/>	Raised Reflective Pavement Markers	Nov. 1, 2025	
* 80455	41	<input checked="" type="checkbox"/>	Removal and Disposal of Regulated Substances	Jan. 1, 2024	April 1, 2026
80474		<input type="checkbox"/>	Residential Driveway Temporary Signal	Nov. 1, 2025	
80445		<input type="checkbox"/>	Seeding	Nov. 1, 2022	
80457	43	<input checked="" type="checkbox"/>	Short Term and Temporary Pavement Markings	April 1, 2024	April 2, 2024
80462		<input type="checkbox"/>	Sign Panels and Appurtenances	Jan. 1, 2025	Jan. 1, 2026
80479		<input type="checkbox"/>	Sinusoidal Rumble Strips	Jan. 1, 2026	
80469		<input type="checkbox"/>	Slope Wall	Aug. 1, 2025	
80448	47	<input checked="" type="checkbox"/>	Source of Supply and Quality Requirements	Jan. 2, 2023	Jan. 1, 2026
80340		<input type="checkbox"/>	Speed Display Trailer	April 2, 2014	Jan. 1, 2022
80127		<input type="checkbox"/>	Steel Cost Adjustment	April 2, 2004	Nov. 1, 2025
80480		<input type="checkbox"/>	Structural Repair of Concrete	Jan. 1, 2026	
80397	49	<input checked="" type="checkbox"/>	Subcontractor and DBE Payment Reporting	April 2, 2018	
80391	50	<input checked="" type="checkbox"/>	Subcontractor Mobilization Payments	Nov. 2, 2017	April 1, 2019
80463	51	<input checked="" type="checkbox"/>	Submission of Bidders List Information	Jan. 2, 2025	Mar. 2, 2025

File Name	Pg.		Special Provision Title	Effective	Revised
* 80482	52	<input checked="" type="checkbox"/>	Submission of Payroll Records – Federal Aid Contract	April 1, 2026	
* 80437		<input type="checkbox"/>	Submission of Payroll Records – State Contract	April 1, 2021	April 1, 2026
80435		<input type="checkbox"/>	Surface Testing of Pavements – IRI	Jan. 1, 2021	Jan. 1, 2023
80465	54	<input checked="" type="checkbox"/>	Surveying Services	April 1, 2025	
80481		<input type="checkbox"/>	Temporary Concrete Barrier	Jan. 1, 2026	
80466		<input type="checkbox"/>	Temporary Rumble Strips	April 1, 2025	
80470		<input type="checkbox"/>	Traffic Signal Backplate	Aug. 1, 2025	
20338		<input type="checkbox"/>	Training Special Provisions	Oct. 15, 1975	Sept. 2, 2021
80429		<input type="checkbox"/>	Ultra-Thin Bonded Wearing Course	April 1, 2020	Jan. 1, 2022
80439	55	<input checked="" type="checkbox"/>	Vehicle and Equipment Warning Lights	Nov. 1, 2021	Nov. 1, 2022
80458		<input type="checkbox"/>	Waterproofing Membrane System	Aug. 1, 2024	
80302		<input type="checkbox"/>	Weekly DBE Trucking Reports	June 2, 2012	Jan. 2, 2025
80454		<input type="checkbox"/>	Wood Sign Support	Nov. 1, 2023	
80427		<input type="checkbox"/>	Work Zone Traffic Control Devices	Mar. 2, 2020	Jan. 1, 2026
80071	56	<input checked="" type="checkbox"/>	Working Days	Jan. 1, 2002	

SPECIAL PROVISIONS

The following Special Provision supplement the “Standard Specifications for Road and Bridge Construction”, adopted January 1, 2022, “Supplemental Specifications” adopted January 1, 2026, the latest edition of the “Illinois Manual on Uniform Traffic Control Devices for Streets and Highways”, and the “Manual of Test Procedures for Materials” in effect on the date of invitation for bids and the Supplemental Specifications and Recurring Special Provisions indicated on the Check Sheet included herein which apply to and govern the construction of Section 23-00119-00-RS in Hamilton County, and in case of conflict with any part, or parts of said Specifications, the said Special Provisions shall take precedence and shall govern.

LOCATION OF WORK

The work on this project is located on Blairsville Road from IL 242 west 10.75 miles to the White County Line.

DESCRIPTION OF WORK

The proposed improvement consists of the construction of Longitudinal Joint Seal, Bituminous Tack Coat, Hot Mix Asphalt Binder Course, Hot Mix Asphalt Surface Course, Aggregate Wedge Shoulder, Pavement Marking and other miscellaneous work necessary to complete the project.

TRAFFIC CONTROL AND PROTECTION, (SPECIAL)

The Contractor will be required to keep the road open to through traffic during construction of the proposed improvement.

Traffic Control shall be in accordance with the applicable sections of the Standard Specifications for Road and Bridge Construction, the applicable guidelines contained in the Illinois Manual on Uniform Traffic Control Devices for Streets and Highways, these special provisions, and any special details and Highway Standards contained herein and in the plans.

Prior to construction beginning, the Contractor shall furnish the name of the individual in his direct employ who is to be responsible for the installation and maintenance of the traffic control for the project. If the actual installation and maintenance are to be

accomplished by a Subcontractor, consent shall be requested of the Engineer prior to the construction beginning in accordance with Article 108.01 of the Standard Specifications. This shall not relieve the Contractor of the foregoing requirement for a responsible individual in his employ.

Special attention is called to Articles 107.09 and 107.14 of the Standard Specifications and the following Highway Standards: 701001, 701006, 701011, 701201, 701301, 701306, 701311 and 701901.

All labor, material, and equipment necessary to perform the work for the duration of the project will be paid for at the contract unit price, Lump Sum, for Traffic Control and Protection, (Special).

UTILITIES

There are no known utilities within the limits of this improvement requiring adjustment. It shall be the Contractor's responsibility to determine the actual location of all such facilities, known or unknown.

J.U.L.I.E. 1-800-892-0123

SIDE ROAD APPROACHES, COMMERCIAL ENTRANCES, PRIVATE ENTRANCES AND MAILBOX TURN-OUTS

The surfacing of side road approaches, commercial entrances, private entrances and mailbox turn-outs shall be a 3' wedge as shown on the plans or as directed by the Engineer. The surface shall be cleaned and primed prior to construction of the HMA surface wedge. The cost of furnishing the materials, labor, and equipment necessary for this work will not be paid for separately, but shall be included in the contract unit price per TON for Hot Mix Asphalt Surface Course Mix C, IL-9.5 N50, and no additional compensation will be allowed.

HMA SURFACE REMOVAL 1/2"

Disposal of Material.

Materials resulting from the removal of existing pavement and appurtenances as herein specified shall be placed along the foreslope of the roadway. The material shall then be shaped and graded to blend into the foreslope and to allow proper drainage prior to the placement of the HMA surface course and aggregate shoulders. All labor and equipment necessary for this work will not be paid for separately, but shall be included in the contract unit price per SQ YD for HMA Surface Removal 1/2" and no additional compensation will be allowed.

AGGREGATE SHOULDER, TYPE B

At Side Roads, Entrances, and Mailboxes.

The same type and gradation of material used for constructing the aggregate shoulders shall be used at side roads, entrances, and mailbox turnouts to construct a wedge from the back of asphalt surface to the existing aggregate or earthen surface where necessary. All labor and equipment necessary for this work will not be paid for separately, but shall be included in the contract unit price per TON for Aggregate Shoulder, Type B and no additional compensation will be allowed.

State of Illinois
Department of Transportation
Bureau of Local Roads and Streets

SPECIAL PROVISION
FOR
INSURANCE

Effective: February 1, 2007
Revised: August 1, 2007

All references to Sections or Articles in this specification shall be construed to mean specific Section or Article of the Standard Specifications for Road and Bridge Construction, adopted by the Department of Transportation.

The Contractor shall name the following entities as additional insured under the Contractor's general liability insurance policy in accordance with Article 107.27:

Hamilton County

910 East Randolph

McLeansboro, IL 62859

The entities listed above and their officers, employees, and agents shall be indemnified and held harmless in accordance with Article 107.26.

State of Illinois
 DEPARTMENT OF TRANSPORTATION
 Bureau of Local Roads & Streets
 SPECIAL PROVISION
 FOR
 LOCAL QUALITY ASSURANCE/ QUALITY MANAGEMENT QC/QA
 Effective: January 1, 2022

Replace the first five paragraphs of Article 1030.06 of the Standard Specifications with the following:

“1030.06 Quality Management Program. The Quality Management Program (QMP) will be Quality Control / Quality Assurance (QC/QA) according to the following.”

Delete Article 1030.06(d)(1) of the Standard Specifications.

Revise Article 1030.09(g)(3) of the Standard Specifications to read:

“(3) If core testing is the density verification method, the Contractor shall provide personnel and equipment to collect density verification cores for the Engineer. Core locations will be determined by the Engineer following the document “Hot-Mix Asphalt QC/QA Procedure for Determining Random Density Locations” at density verification intervals defined in Article 1030.09(b). After the Engineer identifies a density verification location and prior to opening to traffic, the Contractor shall cut a 4 in. (100 mm) diameter core. With the approval of the Engineer, the cores may be cut at a later time.”

Revise Article 1030.09(h)(2) of the Standard Specifications to read:

“(2) After final rolling and prior to paving subsequent lifts, the Engineer will identify the random density verification test locations. Cores or nuclear density gauge testing will be used for density verification. The method used for density verification will be as selected below.

Density Verification Method	
<input type="checkbox"/>	Cores
<input checked="" type="checkbox"/>	Nuclear Density Gauge (Correlated when paving ≥ 3,000 tons per mixture)

Density verification test locations will be determined according to the document “Hot-Mix Asphalt QC/QA Procedure for Determining Random Density Locations”. The density testing interval for paving wider than or equal to 3 ft (1 m) will be 0.5 miles (800 m) for lift thicknesses of 3 in. (75 mm) or less and 0.2 miles (320 m) for lift thicknesses greater than 3 in. (75 mm). The density testing interval for paving less than 3 ft (1 m) wide will be 1 mile (1,600 m). If a day’s paving will be less than the prescribed density testing interval, the length of the day’s paving will be the interval for that day. The density testing interval for mixtures used for patching will be 50 patches with a minimum of one test per mixture per project.

If core testing is the density verification method, the Engineer will witness the Contractor coring, and secure and take possession of all density samples at the

density verification locations. The Engineer will test the cores collected by the Contractor for density according to Illinois Modified AASHTO T 166 or AASHTO T 275.

If nuclear density gauge testing is the density verification method, the Engineer will conduct nuclear density gauge tests. The Engineer will follow the density testing procedure detailed in the document "Illinois Modified ASTM D 2950, Standard Test Method for Density of Bituminous Concrete In-Place by Nuclear Method".

A density verification test will be the result of a single core or the average of the nuclear density tests at one location. The results of each density test must be within acceptable limits. The Engineer will promptly notify the Contractor of observed deficiencies."

Revise the seventh paragraph and all subsequent paragraphs in Section D. of the document "Hot-Mix Asphalt QC/QA Initial Daily Plant and Random Samples" to read:

"Mixtures shall be sampled from the truck at the plant by the Contractor following the same procedure used to collect QC mixture samples (Section A). This process will be witnessed by the Engineer who will take custody of the verification sample. Each sample bag with a verification mixture sample will be secured by the Engineer using a locking ID tag. Sample boxes containing the verification mixture sample will be sealed/taped by the Engineer using a security ID label."

CEMENT, FINELY DIVIDED MINERALS, ADMIXTURES, CONCRETE, AND MORTAR (BDE)

Effective: January 1, 2025

Revised: January 1, 2026

Revise the first paragraph of Article 285.05 of the Standard Specifications to read:

“285.05 Fabric Formed Concrete Revetment Mat. The grout shall consist of a mixture of cement, fine aggregate, and water so proportioned and mixed as to provide a pumpable slurry. Fly ash or ground granulated blast furnace (GGBF) slag, and concrete admixtures may be used at the option of the Contractor. The grout shall have an air content of not less than 6.0 percent nor more than 9.0 percent of the volume of the grout. The mix shall obtain a compressive strength of 2500 psi (17,000 kPa) at 28 days according to Article 1020.09.”

Revise Article 302.02 of the Standard Specifications to read:

“302.02 Materials. Materials shall be according to the following.

Item	Article/Section
(a) Cement	1001
(b) Water	1002
(c) Hydrated Lime	1012.01
(d) By-Product, Hydrated Lime	1012.02
(e) By-Product, Non-Hydrated Lime	1012.03
(f) Lime Slurry	1012.04
(g) Fly Ash	1010
(h) Soil for Soil Modification (Note 1)	1009.01
(i) Bituminous Materials (Note 2)	1032

Note 1. This soil requirement only applies when modifying with lime (slurry or dry).

Note 2. The bituminous materials used for curing shall be emulsified asphalt RS-2, CRS-2, HFE 90, or HFE 150; rapid curing liquid asphalt RC-70; or medium curing liquid asphalt MC-70 or MC-250.”

Revise Article 312.07(c) of the Standard Specifications to read:

“(c) Cement 1001”

Add Article 312.07(i) of the Standard Specifications to read:

“(i) Ground Granulated Blast Furnace (GGBF) Slag 1010”

Revise the first paragraph of Article 312.09 of the Standard Specifications to read:

“312.09 Proportioning and Mix Design. At least 60 days prior to start of placing CAM II, the Contractor shall submit samples of materials to be used in the work for proportioning and testing. The mixture shall contain a minimum of 200 lb (120 kg) of cement per cubic yard (cubic meter). Cement may be replaced with fly ash or ground granulated blast furnace (GGBF) slag according to Article 1020.05(c)(1) or 1020.05(c)(2), respectively, however the minimum cement content in the mixture shall be 170 lbs/cu yd (101 kg/cu m). Blends of coarse and fine aggregates will be permitted, provided the volume of fine aggregate does not exceed the volume of coarse aggregate. The Engineer will determine the proportions of materials for the mixture according to the “Portland Cement Concrete Level III Technician Course” manual. However, the Contractor may substitute their own mix design. Article 1020.05(a) shall apply, and a Level III PCC Technician shall develop the mix design.”

Revise Article 352.02 of the Standard Specifications to read:

“352.02 Materials. Materials shall be according to the following.

Item	Article/Section
(a) Cement (Note 1)	1001
(b) Soil for Soil-Cement Base Course	1009.03
(c) Water	1002
(d) Bituminous Materials (Note 2)	1032

Note 1. Bulk cement may be used for the traveling mixing plant method if the equipment for handling, weighing, and spreading the cement is approved by the Engineer.

Note 2. The bituminous materials used for curing shall be emulsified asphalt RS-2, CRS-2, HFE 90, or HFE 150; rapid curing liquid asphalt RC-70; or medium curing liquid asphalt MC-70 or MC-250.”

Revise Article 404.02 of the Standard Specifications to read:

“404.02 Materials. Materials shall be according to the following.

Item	Article/Section
(a) Cement	1001
(b) Water	1002
(c) Fine Aggregate	1003.08
(d) Bituminous Material (Tack Coat)	1032.06
(e) Emulsified Asphalts (Note 1) (Note 2)	1032.06
(f) Fiber Modified Joint Sealer	1050.05
(g) Additives (Note 3)	

Note 1. When used for slurry seal, the emulsified asphalt shall be CQS-1h according to Article 1032.06(b).

Note 2. When used for micro-surfacing, the emulsified asphalt shall be CQS-1hP according to Article 1032.06(e).

Note 3. Additives may be added to the emulsion mix or any of the component materials to provide the control of the quick-traffic properties. They shall be included as part of the mix design and be compatible with the other components of the mix.

Revise the last sentence of the fourth paragraph of Article 404.08 of the Standard Specifications to read:

“When approved by the Engineer, the sealant may be dusted with fine sand, cement, or mineral filler to prevent tracking.”

Revise Note 2 of Article 516.02 of the Standard Specifications to read:

“Note 2. The sand-cement grout mix shall be according to Section 1020 and shall be a 1:1 blend of sand and cement comprised of a Type I, IL, or II cement at 185 lb/cu yd (110 kg/cu m). The maximum water cement ratio shall be sufficient to provide a flowable mixture with a typical slump of 10 in. (250 mm).”

Revise Note 2 of Article 543.02 of the Standard Specifications to read:

“Note 2. The grout mixture shall be 6.50 hundredweight/cu yd (385 kg/cu m) of cement plus fine aggregate and water. Fly ash or ground granulated blast furnace (GGBF) slag may replace a maximum of 5.25 hundredweight/cu yd (310 kg/cu m) of the cement. The water/cement ratio, according to Article 1020.06, shall not exceed 0.60. An air-entraining admixture shall be used to produce an air content, according to Article 1020.08, of not less than 6.0 percent nor more than 9.0 percent of the volume of the grout. The Contractor shall have the option to use a water-reducing or high range water-reducing admixture.”

Revise Article 583.01 of the Standard Specifications to read:

“**583.01 Description.** This work shall consist of placing cement mortar along precast, prestressed concrete bridge deck beams as required for fairing out any unevenness between adjacent deck beams prior to placing of waterproofing membrane and surfacing.”

Revise Article 583.02(a) of the Standard Specifications to read:

“(a) Cement 1001”

Revise the first paragraph of Article 583.03 of the Standard Specifications to read:

“**583.03 General.** This work shall only be performed when the air temperature is 45 °F (7 °C) and rising. The mixture for cement mortar shall consist of three parts sand to one part cement by volume. The amount of water shall be no more than that necessary to produce a workable, plastic mortar.”

Revise Article 606.02(h) of the Standard Specifications to read:

“(h) Fibers (Note 1)1014”

Revise Note 1 in Article 606.02(h) of the Standard Specifications to read:

“Note 1. Fibers, when required, shall only be used in the concrete mixture for slipform applications.”

Revise the third paragraph in Article 606.10 of the Standard Specifications to read:

“Welded wire fabric shall be 6 x 6 in. (150 x 150 mm) mesh, #4 gauge (5.74 mm), 58 lb (26 kg) per 100 sq ft (9 sq m).”

Revise Article 1001.01(d) of the Standard Specifications to read:

“(d) Rapid Hardening Cement. Rapid hardening cement shall be according to the Bureau of Materials Policy Memorandum “Portland or Blended Cement Acceptance Procedure for Qualified and Non-Qualified Plants”, and ASTM C 1600, Type URH, Type VRH, or Type RH-CAC. It shall be used according to Article 1020.04 or when approved by the Engineer. The Contractor shall submit a report from the manufacturer or an independent lab that contains results for testing according to ASTM C 1600 which shows the cement meets the requirements of either Type URH, Type VRH, or Type RH-CAC. Test data shall be less than 1 year old from the date of submittal.

Revise Article 1001.01(e) of the Standard Specifications to read:

“(e) Other Cements. Other cements shall be according to the Bureau of Materials Policy Memorandum “Portland or Blended Cement Acceptance Procedure for Qualified and Non-Qualified Plants”, and ASTM C 1157 or ASTM C 1600, as applicable. Other cements shall be used according to Article 1020.04 or when approved by the Engineer. For cements according to ASTM C 1157, the Contractor shall submit a report from the manufacturer or an independent lab that contains results of tests which shows the cement meets the requirements Type GU, HE, MS, MH, or LH. For cements according to ASTM C 1600, the Contractor shall submit a report from the manufacturer or an independent lab that contains results of tests which shows the cement meets the requirements Type MRH or GRH. Test data shall be less than 1 year old from the date of submittal.”

Revise Article 1002.02 of the Standard Specifications to read:

“**1002.02 Quality.** Water used with cement in concrete or mortar and water used for curing concrete shall be clean, clear, and free from sugar. In addition, water shall be tested and evaluated for acceptance according to one of the following options.

OPTION 1.

(a) Acceptable limits for acidity and alkalinity when tested according to ITP T 26.

- (1) Acidity -- 0.1 Normal NaOH 2 ml max.*
 - (2) Alkalinity -- 0.1 Normal HCl..... 10 ml max.*
- *To neutralize 200 ml sample.

(b) Acceptable limits for solids when tested according to the following.

- (1) Organic (ITP T 26)..... 0.02% max.
- (2) Inorganic (ITP T 26)..... 0.30% max.
- (3) Sulfate (SO₄) (ASTM D 516-82) 0.05% max.
- (4) Chloride (ASTM D 512) 0.06% max.

(c) The following tests shall be performed on the water sample and on deionized water. The same cement and sand shall be used for both tests.

- (1) Unsoundness (ASTM C 151).
- (2) Initial and Final Set Time (ASTM C 266).
- (3) Strength (ASTM C 109).

The test results for the water sample shall not deviate from the test results for the deionized water, except as allowed by the precision in the test method.

OPTION 2. Water shall meet the requirements ASTM C 1602 Tables 1 and 2 as outlined in Sections 5.1, 5.2, and 5.4.”

Revise Note 2/ in Article 1003.01(b) of the Standard Specifications to read:

“2/ Applies only to sand. Sand exceeding the colorimetric test standard of 11 (Illinois Modified AASHTO T 21) will be checked for mortar making properties according to Illinois Modified ASTM C 87 and shall develop a compressive strength at the age of 14 days when using Type I, IL, or II cement of not less than 95 percent of the comparable standard.

Revise the second sentence of Article 1003.02(e)(1) of the Standard Specifications to read:

“The test will be performed with Type I, IL, or II portland cement having a total equivalent alkali content (Na₂O + 0.658K₂O) of 0.90 percent or greater.”

Revise the first sentence of the second paragraph of Article 1003.02(e)(3) of the Standard Specifications to read:

“The ASTM C 1293 test shall be performed with Type I, IL, or II portland cement having a total equivalent alkali content (Na₂O + 0.658K₂O) of 0.80 percent or greater.”

Revise the second sentence of Article 1004.02(g)(1) of the Standard Specifications to read:

“The test will be performed with Type I, IL, or II portland cement having a total equivalent alkali content ($\text{Na}_2\text{O} + 0.658\text{K}_2\text{O}$) of 0.90 percent or greater.”

Add the following Section to the Standard Specifications.

“SECTION 1014. FIBERS FOR CONCRETE

1014.01 General. Fibers used in concrete shall be Type II or Type III (polyolefin or carbon) according to ASTM C 1116. The testing required for Type II fibers or Type III polyolefin fibers shall be performed by an independent lab a minimum of once every five years, and the test results provided to the Department. Manufacturers of Type III carbon fibers shall provide materials certification documentation not more than 6 years old a minimum of once every 5 years to the Department. The Department will maintain a qualified product list. The method of inclusion of fibers into concrete mixtures shall be according to the manufacturer’s specifications.

At the discretion of the Engineer, the concrete mixture shall be evaluated in a field demonstration for fiber clumping, ease of placement, and ease of finishing. The field demonstration shall consist of a minimum 2 cu yd (1.5 cu m) trial batch placed in a 12 ft x 12 ft (3.6 m x 3.6 m) slab.

1014.02 Concrete Gutter, Curb, Median and Paved Ditch. Fibers shall be Type III. Fibers shall have a minimum length of 1/2 in. (13 mm) and a maximum length of 0.75 in. (19 mm). The maximum dosage rate in the concrete mixture shall not exceed 1.5 lb/cu yd (0.9 kg/cu m). The minimum dosage rate shall be per the manufacturer’s recommendation.

1014.03 Concrete Inlay or Overlay. Fibers shall be Type III. Fibers shall have a minimum length of 1.0 in. (25 mm), a maximum length of 2 1/2 in. (63 mm), and a maximum aspect ratio (length divided by the equivalent diameter of the fiber) of 150. The maximum dosage rate shall not exceed 5.0 lb/cu yd (3.0 kg/cu m). The minimum dosage rate shall be per the manufacturer’s recommendation.

1014.04 Bridge Deck Fly Ash, Ground Granulated Blast Furnace (GGBF) Slag, High Reactivity Metakaolin, or Microsilica (Silica Fume) Concrete Overlay. Fibers shall be Type III. The dosage rate shall be a minimum of 3.0 lb/cu yd (1.8 kg/cu m), unless a field demonstration according to Article 1014.01 indicates that a lower dosage rate is necessary. Based on the results of the field demonstration, the Department has the option to reduce the dosage rate of fibers, but the dosage will not be reduced to less than 2.0 lb / cu yd (1.2 kg/cu m).

1014.05 Bridge Deck Latex Concrete Overlay. Fibers shall be Type II or III. Fibers shall have a minimum length of 0.75 in. (19 mm), a maximum length of 1.75 in. (45 mm), and an aspect ratio (length divided by the equivalent diameter of the fiber) of between 70 and 100. The dosage rate shall be a minimum of 3.0 lb/cu yd (1.8 kg/cu m), unless a field demonstration according to Article 1014.01 indicates that a lower dosage rate is necessary. Based on the results of the field

demonstration, the Department has the option to reduce the dosage rate of fibers, but the dosage will not be reduced to less than 2.0 lb/cu yd (1.2 kg/cu m).”

Add the following Section to the Standard Specifications:

“SECTION 1015. HIGH PERFORMANCE SHOTCRETE

1015.01 Packaged Shotcrete With Aggregate. The packaged shotcrete with aggregate shall be a pre-blended dry combination of materials for the wet-mix shotcrete method according to ASTM C 1480, Type FA or CA, Grade FR, Class I. The fibers shall be Type III according to Article 1014.01. The cement and finely divided minerals in the mixture shall be a minimum 6.65 cwt/cu yd (395 kg/cu m), and the portland cement shall not be below 4.70 cwt/cu yd (279 kg/cu m). Microsilica is required in the mixture and shall be a minimum of 5 percent by weight (mass) of cementitious material, and a maximum of 10 percent. Strength requirements shall be according to ASTM C 1480 except that the strength at 28 days shall be at least 4000 psi (27,500 kPa). Strength testing shall be according to ASTM C 1140. The air content as shot shall be 4.0 – 8.0 percent when tested according to AASHTO T 152, and the coarse aggregate shall be a maximum size of 1/2 in. (12.5 mm).

The packaged shotcrete shall have a water soluble chloride ion content of less than 0.15% by weight of cementitious material when tested according to ASTM C 1218 or AASHTO T 260.

The testing according to ASTM C 1480, ASTM C 1140, AASHTO 152, and ASTM C 1218 or AASHTO T 260 shall be performed by an independent lab a minimum of once every 5 years, and the test results shall be provided to the Department. The Department will maintain a qualified product list. Batching and mixing shall be per the manufacturer’s recommendations.

1015.02 Packaged Shotcrete Without Aggregate. The packaged shotcrete that does not include pre-blended aggregate shall be according to Article 1015.01, except the added aggregate shall be according to Articles 1003.02 and 1004.02. The aggregate gradation shall be according to the manufacturer. The Department will maintain a qualified product list. Batching and mixing shall be per the manufacturer’s recommendations.”

Revise Section 1017 of the Standard Specifications to read:

“SECTION 1017. PACKAGED, DRY, COMBINED MATERIALS FOR MORTAR AND CONCRETE

1017.01 Mortar. The mortar shall be high-strength according to ASTM C 387 and shall have a minimum 80.0 percent relative dynamic modulus of elasticity when tested according to AASHTO T 161. For prestressed concrete applications, the mortar shall have a water-soluble chloride ion content of less than 0.06 percent by weight of cementitious material when tested according to ASTM C 1218 or AASHTO T 260; and for non-prestressed concrete applications, the water soluble chloride content shall be less than 0.15 percent by weight of cementitious material. The testing according to ASTM C 387, AASHTO T 161, and either ASTM C 1218 or AASHTO T 260 shall be performed by an independent lab a minimum of once every five years, and the test results

shall be provided to the Department. The Department will maintain a qualified product list. Mixing of the high-strength mortar shall be according to the manufacturer's specifications.

1017.02 Concrete. The materials, testing, and preparation of aggregate for the "high slump" packaged concrete mixture shall be according to ASTM C 387. The mixture shall be air entrained, the slump shall be 5-10 in. (125-250 mm), and the coarse aggregate shall be a maximum size of 1/2 in. (12.5 mm). Strength requirements shall be according to ASTM C 387 except that the strength at 28 days shall be at least 4000 psi (27,500 kPa). The "high slump" packaged concrete mixture shall have a water soluble chloride ion content of less than 0.15% by weight of cementitious material when tested according to ASTM C 1218 or AASHTO T 260. The testing according to ASTM C 387, and either ASTM C 1218 or AASHTO T 260 shall be performed by an independent lab a minimum of once every 5 years, and the test results shall be provided to the Department. The Department will maintain a qualified product list. Mixing shall be per the manufacturer's recommendations.

1017.02 Self-Consolidating Concrete. The materials, testing, and preparation of aggregate for the "self-consolidating concrete" packaged concrete mixture shall be according to ASTM C 387. The mixture shall be air entrained, it should be uniformly graded, and the coarse aggregate shall be a maximum size of 1/2 in. (12.5 mm). Strength requirements shall be according to ASTM C 387 except that the strength at 28 days shall be at least 4000 psi (27,500 Pa). Slump flow range shall be 22 in. (550 mm) minimum to 28 in. (700 mm) maximum when tested according to AASHTO T 347. The visual stability index shall be a maximum of 1 when tested according to AASHTO T 351. At the option of the manufacturer, either the J-Ring value shall be a maximum of 2 in. (50 mm) when tested according to AASHTO T 347 or the L-Box blocking ratio shall be a minimum of 80 percent when tested according AASHTO T 419. The hardened visual stability index shall be a maximum of 1 when tested according to AASHTO R 81.

The "self -consolidating concrete" packaged concrete mixture shall have a water soluble chloride ion content of less than 0.15 percent by weight of cementitious material when tested according to ASTM C 1218 or AASHTO T 260.

The testing according to ASTM C 387, AASHTO T 347, AASHTO T 351, AASHTO T 419, AASHTO R 81, ASTM C 1218 and AASHTO T 260 shall be performed by an independent lab a minimum of once every 5 years, and the test results shall be provided to the Department. The Department will maintain a qualified product list. Mixing shall be per the manufacturer's recommendations."

Revise Article 1018.01 of the Standard Specifications to read:

"1018.01 Requirements. The rapid hardening mortar or concrete shall be according to ASTM C 928 and shall have successfully completed and remain current with the AASHTO Product Eval and Audit Rapid Hardening Concrete Patching Materials (RHCP) testing program. R1, R2, or R3 concrete shall be air entrained, the slump shall be 5-10 in. (125-250 mm), and the coarse aggregate shall be a maximum size of 1/2 in. (12.5 mm). For prestressed concrete applications, the mortar or concrete shall have a water-soluble chloride ion content of less than 0.06 percent by weight of cementitious material when tested according to ASTM C 1218 or AASHTO T 260;

and for non-prestressed concrete applications, the water soluble chloride content shall be less than 0.15 percent by weight of cementitious material. The Department will maintain a qualified product list. Mixing of the mortar or concrete shall be according to the manufacturer's specifications..”

Revise Article 1019.02 of the Standard Specifications to read:

“**1019.02 Materials.** Materials shall be according to the following.

Item	Article/Section
(a) Cement	1001
(b) Water	1002
(c) Fine Aggregate for Controlled Low-Strength Material (CLSM)	1003.06
(d) Fly Ash	1010
(e) Ground Granulated Blast Furnace (GGBF) Slag.....	1010
(f) Admixtures (Note 1)	

Note 1. The air-entraining admixture may be in powder or liquid form. The air content produced by the admixture shall be 15-25 percent when incorporated into Mix 2 or an equivalent mixture as determined by the Department and tested according to AASHTO T 121 or AASHTO T 152. The testing according to AASHTO T 121 or AASHTO T 152 shall be performed by an independent lab a minimum of once every five years, and the test results shall be provided to the Department. The Department will maintain a qualified product list.”

Revise the third paragraph of Article 1019.04 of the Standard Specifications to read:

“The Engineer will instruct the Contractor to adjust the proportions of the mix design in the field as needed to meet the design criteria, provide adequate flowability, maintain proper solid suspension, or other criteria established by the Engineer.”

Revise Article 1019.05 of the Standard Specifications to read:

“**1019.05 Department Mix Design.** The Department mix design shall be Mix 1, 2, or 3 and shall be proportioned to yield approximately one cubic yard (cubic meter).

Mix 1	
Cement	50 lb (30 kg)
Fly Ash – Class C or F, and/or GGBF Slag	125 lb (74 kg)
Fine Aggregate – Saturated Surface Dry	2900 lb (1720 kg)
Water	50-65 gal (248-322 L)
Air Content	No air is entrained

Mix 2	
Cement	125 lb (74 kg)

Fine Aggregate – Saturated Surface Dry	2500 lb (1483 kg)
Water	35-50 gal (173-248 L)
Air Content	15-25 %

Mix 3	
Cement	40 lb (24 kg)
Fly Ash – Class C or F, and/or GGBF Slag	125 lb (74 kg)
Fine Aggregate – Saturated Surface Dry	2500 lb (1483 kg)
Water	35-50 gal (179-248 L)
Air Content	15-25 %

Revise Article 1020.04, Table 1, Note (8) of the Standard Specifications to read:

“(8) In addition to the Type III portland cement, 100 lb/cu yd of ground granulated blast-furnace slag and 50 lb/cu yd of microsilica (silica fume) shall be used. For an air temperature greater than 85 °F, the Type III portland cement may be replaced with Type I, IL, or II portland cement.”

Revise Article 1020.04, Table 1 (Metric), Note (8) of the Standard Specifications to read:

“(8) In addition to the Type III portland cement, 60 kg/cu m of ground granulated blast-furnace slag and 30 kg/cu m of microsilica (silica fume) shall be used. For an air temperature greater than 30 °C, the Type III portland cement may be replaced with Type I, IL, or II portland cement.”

Revise Note 9 of Table 1 of Article 1020.04 of the Standard Specifications to read:

“(9) The cement shall be a rapid hardening according to Article 1001.01(d). Minimum or maximum cement factor may be adjusted when approved by the Engineer.”

Revise the second paragraph of Article 1020.05(a) of the Standard Specifications to read:

“For a mix design using a portland-pozzolan cement, portland blast-furnace slag cement, portland-limestone cement, or replacing portland cement with finely divided minerals per Articles 1020.05(c) and 1020.05(d), the Contractor may submit a mix design with a minimum portland cement content less than 400 lbs/cu yd (237 kg/cu m), but not less than 375 lbs/cu yd (222 kg/cu m), if the mix design is shown to have a minimum relative dynamic modulus of elasticity of 80 percent determined according to AASHTO T 161. Testing shall be performed by an independent laboratory accredited by AASHTO re:source for Portland Cement Concrete.”

Revise the first sentence of the first paragraph of Article 1020.05(b) of the Standard Specifications to read:

“Corrosion inhibitors and concrete admixtures shall be according to the qualified product lists.”

Delete the fourth and fifth sentences of the second paragraph of Article 1020.05(b) of the Standard Specifications.

Revise Article 1020.05(b)(5) of the Standard Specifications to read:

“(5) For Class PP-4 concrete, a high range water-reducing admixture, retarder, and/or hydration stabilizer may be used in addition to the air-entraining admixture. The Contractor also has the option to use a water-reducing admixture with the high range water-reducing admixture. An accelerator shall not be used. A mobile portland cement concrete plant shall be used to produce the patching mixture.

For PP-5 concrete, a non-chloride accelerator, high range water-reducing admixture, retarder, hydration stabilizer, and/or air-entraining admixture may be used. The accelerator, high range water-reducing admixture, retarder, hydration stabilizer, and/or air-entraining admixture shall be per the Contractor’s recommendation and dosage. The qualified product list of concrete admixtures shall not apply. A mobile portland cement concrete plant shall be used to produce the patching mixture.”

Revise second paragraph of Article 1020.05(b)(10) of the Standard Specifications to read:

“When calcium nitrite is used, it shall be added at the rate of 4 gal/cu yd (20 L/cu m) and shall be added to the mix immediately after all compatible admixtures have been introduced to the batch. Other corrosion inhibitors shall be added per the manufacturer’s specifications.”

Delete the third paragraph of Article 1020.05(b)(10) of the Standard Specifications.

Revise Article 1020.15(b)(1)c. of the Standard Specifications to read:

“c. The minimum portland cement content in the mixture shall be 375 lbs/cu yd (222 kg/cu m). When the total of organic processing additions, inorganic processing additions, and limestone addition exceed 5.0 percent in the cement, the minimum portland cement content in the mixture shall be 400 lbs/cu yd (237 kg/cu m). For a drilled shaft, foundation, footing, or substructure, the minimum portland cement may be reduced to as low as 330 lbs/cu yd (196 kg/cu m) if the concrete has adequate freeze/thaw durability. The Contractor shall provide freeze/thaw test results according to AASHTO T 161, and the relative dynamic modulus of elasticity of the mix design shall be a minimum of 80 percent. Testing shall be performed by an independent laboratory accredited by AASHTO re:source for Portland Cement Concrete. Freeze/thaw testing will not be required for concrete that will not be exposed to freezing and thawing conditions as determined by the Engineer.”

Revise Article 1021.01 of the Standard Specifications to read:

“1021.01 General. Admixtures shall be furnished in liquid or powder form ready for use. The admixtures shall be delivered in the manufacturer's original containers, bulk tank trucks or such containers or tanks as are acceptable to the Engineer. Delivery shall be accompanied by a ticket which clearly identifies the manufacturer, the date of manufacture, and trade name of the material. Containers shall be readily identifiable as to manufacturer, the date of manufacture, and trade name of the material they contain.

Concrete admixtures shall be on one of the Department's qualified product lists. Unless otherwise noted, admixtures shall have successfully completed and remain current with the AASHTO Product Eval and Audit Concrete Admixture (CADD) testing program. For admixture submittals to the Department; the product brand name, manufacturer name, admixture type or types, an electronic link to the product's technical data sheet, and the NTPEP testing number which contains an electronic link to all test data shall be provided. In addition, a letter shall be submitted certifying that no changes have been made in the formulation of the material since the most current round of tests conducted by AASHTO Product Eval and Audit. After 28 days of testing by AASHTO Product Eval and Audit, air-entraining admixtures may be provisionally approved and used on Departmental projects. For all other admixtures, unless otherwise noted, the time period after which provisionally approved status may be earned is 6 months.

The manufacturer shall include the following in the submittal to the AASHTO Product Eval and Audit CADD testing program: the manufacturing range for specific gravity, the midpoint and manufacturing range for residue by oven drying, and manufacturing range of pH. The submittal shall also include an infrared spectrophotometer trace no more than five years old.

For air-entraining admixtures according to Article 1021.02, the specific gravity allowable manufacturing range established by the manufacturer shall be according to AASHTO M 194. For residue by oven drying and pH, the allowable manufacturing range and test methods shall be according to AASHTO M 194.

For admixtures according to Articles 1021.03, 1021.04, 1021.05, 1021.06, 1021.07, and 1021.08, the pH allowable manufacturing range established by the manufacturer shall be according to ASTM E 70. For specific gravity and residue by oven drying, the allowable manufacturing range and test methods shall be according to AASHTO M 194.

All admixtures, except chloride-based accelerators, shall contain a maximum of 0.3 percent chloride by weight (mass) as determined by an appropriate test method. To verify the test result, the Department will use Illinois Modified AASHTO T 260, Procedure A, Method 1.

Prior to final approval of an admixture, the Engineer reserves the right to request a sample for testing. The test and reference concrete mixtures tested by the Engineer will contain a cement content of 5.65 cwt/cu yd (335 kg/cu m). For freeze-thaw testing, the Department will perform the test according to Illinois Modified AASHTO T 161. The flexural strength test will be performed according to AASHTO T 177. If the Engineer decides to test the admixture, the manufacturer shall submit AASHTO T 197 water content and set time test results on the standard cement used by the Department. The manufacturer may select their lab or an independent lab to perform this testing. The laboratory is not required to be accredited by AASHTO.

Random field samples may be taken by the Department to verify an admixture meets specification. A split sample will be provided to the manufacturer if requested. Admixtures that do not meet specification requirements or an allowable manufacturing range established by the manufacturer shall be replaced with new material.”

Revise Article 1021.03 of the Standard Specifications to read:

“**1021.03 Retarding and Water-Reducing Admixtures.** The admixture shall be according to the following.

- (a) Retarding admixtures shall be according to AASHTO M 194, Type B (retarding) or Type D (water-reducing and retarding).
- (b) Water-reducing admixtures shall be according to AASHTO M 194, Type A.
- (c) High range water-reducing admixtures shall be according to AASHTO M 194, Type F (high range water-reducing) or Type G (high range water-reducing and retarding).”

Revise Article 1021.05 of the Standard Specifications to read:

“**1021.05 Self-Consolidating Admixtures.** Self-consolidating admixture systems shall consist of either a high range water-reducing admixture only or a high range water-reducing admixture combined with a separate viscosity modifying admixture. The one or two component admixture system shall be capable of producing a concrete that can flow around reinforcement and consolidate under its own weight without additional effort and without segregation.

High range water-reducing admixtures shall be according to AASHTO M 194, Type F.

Viscosity modifying admixtures shall be according to AASHTO M 194, Type S (specific performance).”

Revise Article 1021.06 of the Standard Specifications to read:

“**1021.06 Rheology-Controlling Admixture.** Rheology-controlling admixtures shall be capable of producing a concrete mixture with a lower yield stress that will consolidate easier for slipform applications used by the Contractor. Rheology-controlling admixtures shall be according to AASHTO M 194, Type S (specific performance).”

Revise Article 1021.07 of the Standard Specifications to read:

“**1021.07 Corrosion Inhibitor.** The corrosion inhibitor shall be according to one of the following.

- (a) Calcium Nitrite. Corrosion inhibitors shall contain a minimum 30 percent calcium nitrite by weight (mass) of solution and shall comply with either the requirements of AASHTO

M 194, Type C (accelerating) or the requirements of ASTM C 1582. The corrosion inhibiting performance requirements of ASTM C 1582 shall not apply.

(b) Other Materials. The corrosion inhibitor shall be according to ASTM C 1582.

For submittals requiring testing according to ASTM M 194, Type C (accelerating), the admixture shall meet the requirements of the AASHTO Product Eval and Audit CADD testing program according to Article 1021.01.

For submittals requiring testing according to ASTM C 1582, a report prepared by an independent laboratory accredited by AASHTO re:source for portland cement concrete shall be provided. The report shall show the results of physical tests conducted no more than five years prior to the time of submittal, according to applicable specifications. However, ASTM G 109 test information specified in ASTM C 1582 is not required to be from an independent accredited lab. All other information in ASTM C 1582 shall be from an independent accredited lab. Test data and other information required to be submitted to AASHTO Product Eval and Audit according to Article 1021.01, shall instead be submitted directly to the Department.”

Add Article 1021.08 of the Standard Specifications as follows:

“**1021.08 Other Specific Performance Admixtures.** Other specific performance admixtures shall, at a minimum, be according to AASHTO M 194, Type S (specific performance). The Department also reserves the right to require other testing, as determined by the Engineer, to show evidence of specific performance characteristics.

Initial testing according to AASHTO M 194 may be conducted under the AASHTO Product Eval and Audit CADD testing program according to Article 1021.01, or by an independent laboratory accredited by AASHTO re:source for Portland Cement Concrete. In either case, test data and other information required to be submitted to AASHTO Product Eval and Audit according to Article 1021.01, shall also be submitted directly to the Department. The independent accredited lab report shall show the results of physical tests conducted no more than five years prior to the time of submittal, according to applicable specifications.”

Add Article 1021.09 of the Standard Specifications as follows:

“**1021.09 Latex Admixtures.** The latex admixture shall be a uniform, homogeneous, non-toxic, film-forming, polymeric emulsion in water to which all stabilizers have been added at the point of manufacture. The latex admixture shall not contain any chlorides and shall contain 46-49 percent solids.

In lieu of meeting the requirements of Article 1021.01, the Contractor shall submit a manufacturer's certification that the latex emulsion meets the requirements of FHWA Research Report RD-78-35, Chapter VI. The certificate shall include the date of manufacture of the latex admixture, batch or lot number, quantity represented, manufacturer's name, and the location of the manufacturing plant. The latex emulsion shall be sampled and tested in accordance with RD-78-35, Chapter VII, Certification Program.

The latex admixture shall be packaged and stored in containers and storage facilities which will protect the material from freezing and from temperatures above 85°F (30°C). Additionally, the material shall not be stored in direct sunlight and shall be shaded when stored outside of buildings during moderate temperatures.”

Revise Article 1024.01 of the Standard Specifications to read:

“1024.01 Requirements for Grout. The grout shall be proportioned by dry volume, thoroughly mixed, and shall have a minimum temperature of 50 °F (10 °C). Water shall not exceed the minimum needed for placement and finishing.

Materials for the grout shall be according to the following.

Item	Article/Section
(a) Cement	1001
(b) Water	1002
(c) Fine Aggregate	1003.02
(d) Fly Ash	1010
(e) Ground Granulated Blast Furnace (GGBF) Slag.....	1010
(f) Concrete Admixtures	1021”

Revise Note 1 of Article 1024.02 of the Standard Specifications to read:

“Note 1. Nonshrink grout shall be according to ASTM C 1107.

For prestressed concrete applications, the nonshrink grout shall have a water soluble chloride ion content of less than 0.06 percent by weight of cementitious material when tested according to ASTM C 1218 or AASHTO T 260; and for non-prestressed concrete applications, the water soluble chloride ion content shall be less than 0.15 percent by weight of cementitious material. The testing according to ASTM 1107, and either ASTM C 1218 or AASHTO T 260 shall be performed by an independent lab a minimum of once every five years, and the test results shall be provided to the Department. The Department will maintain a qualified product list. Mixing of the nonshrink grout shall be according to the manufacturer’s specifications.”

Revise Article 1029.02 of the Standard Specifications to read:

“1029.02 Materials. Materials shall be according to the following.

Item	Article/Section
(a) Cement.....	1001
(b) Fly Ash	1010
(c) Ground Granulated Blast Furnace (GGBF) Slag	1010
(d) Water.....	1002
(e) Fine Aggregate.....	1003
(f) Concrete Admixtures	1021

(g) Foaming Agent (Note 1)

Note 1. The manufacturer shall submit infrared spectrophotometer trace and test results indicating the foaming agent meets the requirements of ASTM C 869 in order to be on the Department's qualified product list. Submitted data/results shall not be more than five years old."

Revise the second paragraph of Article 1103.03(a)(4) the Standard Specifications to read:

"The dispenser system shall provide a visual indication that the liquid admixture is actually entering the batch, such as via a transparent or translucent section of tubing or by independent check with an integrated secondary metering device. If approved by the Engineer, an alternate indicator may be used for admixtures dosed at rates of 25 oz/cwt (1630 mL/100 kg) or greater, such as accelerating admixtures, corrosion inhibitors, and viscosity modifying admixtures."

Revise Article 1103.04 of the Standard Specifications to read:

"1103.04 Mobile Portland Cement Concrete Plants. The mobile concrete plant shall be according to AASHTO M 241 and the Bureau of Materials Policy Memorandum "Approval of Volumetric Mobile Mixers for Concrete". The mixer shall be capable of carrying sufficient unmixed materials to produce not less than 6 cu yd (4.6 cu m) of concrete."

Revise the first two sections of Check Sheet #11 "Subsealing of Concrete Pavements" of the Recurring Special Provisions to read:

"Description. This work shall consist of filling voids beneath rigid and composite pavements with cement grout.

Materials. Materials shall be according to the following Articles/Sections of the Standard Specifications:

Item	Article/Section
(a) Cement	1001
(b) Water	1002
(c) Fly Ash	1010
(d) Ground Granulated Blast Furnace (GGBF) Slag.....	1010
(e) Admixtures	1021
(f) Packaged Rapid Hardening Mortar or Concrete	1018"

Revise the Materials section of Check Sheet #28 "Portland Cement Concrete Inlay or Overlay" of the Recurring Special Provisions to read:

"Materials. Materials shall be according to the following Articles/Sections of the Standard Specifications.

Item	Article/Section
(a) Portland Cement Concrete (Note 1)	1020
(b) Fibers for Concrete.....	1014
(c) Protective Coat.....	1023.01

Note 1. Class PV concrete shall be used, except the cement factor for central mixed concrete shall be 6.05 cwt/cu yd (360 kg/cu m). A cement factor reduction according to Article 1020.05(b)(8) of the Standard Specifications will be permitted. CA 5 shall not be used and CA 7 may only be used for overlays that are a minimum of 4.5 in. (113 mm) thick. The Class PV concrete shall have a minimum flexural strength of 550 psi (3800 kPa) or a minimum compressive strength of 3000 psi (20,700 kPa) at 14 days.”

80460

COMPENSABLE DELAY COSTS (BDE)

Effective: June 2, 2017

Revised: April 1, 2019

Revise Article 107.40(b) of the Standard Specifications to read:

“(b) Compensation. Compensation will not be allowed for delays, inconveniences, or damages sustained by the Contractor from conflicts with facilities not meeting the above definition; or if a conflict with a utility in an unanticipated location does not cause a shutdown of the work or a documentable reduction in the rate of progress exceeding the limits set herein. The provisions of Article 104.03 notwithstanding, compensation for delays caused by a utility in an unanticipated location will be paid according to the provisions of this Article governing minor and major delays or reduced rate of production which are defined as follows.

- (1) Minor Delay. A minor delay occurs when the work in conflict with the utility in an unanticipated location is completely stopped for more than two hours, but not to exceed two weeks.
- (2) Major Delay. A major delay occurs when the work in conflict with the utility in an unanticipated location is completely stopped for more than two weeks.
- (3) Reduced Rate of Production Delay. A reduced rate of production delay occurs when the rate of production on the work in conflict with the utility in an unanticipated location decreases by more than 25 percent and lasts longer than seven calendar days.”

Revise Article 107.40(c) of the Standard Specifications to read:

“(c) Payment. Payment for Minor, Major, and Reduced Rate of Production Delays will be made as follows.

- (1) Minor Delay. Labor idled which cannot be used on other work will be paid for according to Article 109.04(b)(1) and (2) for the time between start of the delay and the minimum remaining hours in the work shift required by the prevailing practice in the area.

Equipment idled which cannot be used on other work, and which is authorized to standby on the project site by the Engineer, will be paid for according to Article 109.04(b)(4).

- (2) Major Delay. Labor will be the same as for a minor delay.

Equipment will be the same as for a minor delay, except Contractor-owned equipment will be limited to two weeks plus the cost of move-out to either the

Contractor's yard or another job and the cost to re-mobilize, whichever is less. Rental equipment may be paid for longer than two weeks provided the Contractor presents adequate support to the Department (including lease agreement) to show retaining equipment on the job is the most economical course to follow and in the public interest.

- (3) Reduced Rate of Production Delay. The Contractor will be compensated for the reduced productivity for labor and equipment time in excess of the 25 percent threshold for that portion of the delay in excess of seven calendar days. Determination of compensation will be in accordance with Article 104.02, except labor and material additives will not be permitted.

Payment for escalated material costs, escalated labor costs, extended project overhead, and extended traffic control will be determined according to Article 109.13.”

Revise Article 108.04(b) of the Standard Specifications to read:

“(b) No working day will be charged under the following conditions.

- (1) When adverse weather prevents work on the controlling item.
- (2) When job conditions due to recent weather prevent work on the controlling item.
- (3) When conduct or lack of conduct by the Department or its consultants, representatives, officers, agents, or employees; delay by the Department in making the site available; or delay in furnishing any items required to be furnished to the Contractor by the Department prevents work on the controlling item.
- (4) When delays caused by utility or railroad adjustments prevent work on the controlling item.
- (5) When strikes, lock-outs, extraordinary delays in transportation, or inability to procure critical materials prevent work on the controlling item, as long as these delays are not due to any fault of the Contractor.
- (6) When any condition over which the Contractor has no control prevents work on the controlling item.”

Revise Article 109.09(f) of the Standard Specifications to read:

“(f) Basis of Payment. After resolution of a claim in favor of the Contractor, any adjustment in time required for the work will be made according to Section 108. Any adjustment in the costs to be paid will be made for direct labor, direct materials, direct equipment, direct jobsite overhead, direct offsite overhead, and other direct costs allowed by the resolution. Adjustments in costs will not be made for interest charges, loss of anticipated profit, undocumented loss of efficiency, home office overhead and unabsorbed overhead

other than as allowed by Article 109.13, lost opportunity, preparation of claim expenses and other consequential indirect costs regardless of method of calculation.

The above Basis of Payment is an essential element of the contract and the claim cost recovery of the Contractor shall be so limited.”

Add the following to Section 109 of the Standard Specifications.

“109.13 Payment for Contract Delay. Compensation for escalated material costs, escalated labor costs, extended project overhead, and extended traffic control will be allowed when such costs result from a delay meeting the criteria in the following table.

Contract Type	Cause of Delay	Length of Delay
Working Days	Article 108.04(b)(3) or Article 108.04(b)(4)	No working days have been charged for two consecutive weeks.
Completion Date	Article 108.08(b)(1) or Article 108.08(b)(7)	The Contractor has been granted a minimum two week extension of contract time, according to Article 108.08.

Payment for each of the various costs will be according to the following.

- (a) Escalated Material and/or Labor Costs. When the delay causes work, which would have otherwise been completed, to be done after material and/or labor costs have increased, such increases will be paid. Payment for escalated material costs will be limited to the increased costs substantiated by documentation furnished by the Contractor. Payment for escalated labor costs will be limited to those items in Article 109.04(b)(1) and (2), except the 35 percent and 10 percent additives will not be permitted.
- (b) Extended Project Overhead. For the duration of the delay, payment for extended project overhead will be paid as follows.
 - (1) Direct Jobsite and Offsite Overhead. Payment for documented direct jobsite overhead and documented direct offsite overhead, including onsite supervisory and administrative personnel, will be allowed according to the following table.

Original Contract Amount	Supervisory and Administrative Personnel
Up to \$5,000,000	One Project Superintendent
Over \$ 5,000,000 - up to \$25,000,000	One Project Manager, One Project Superintendent or Engineer, and One Clerk
Over \$25,000,000 - up to \$50,000,000	One Project Manager, One Project Superintendent, One Engineer, and

	One Clerk
Over \$50,000,000	One Project Manager, Two Project Superintendents, One Engineer, and One Clerk

(2) Home Office and Unabsorbed Overhead. Payment for home office and unabsorbed overhead will be calculated as 8 percent of the total delay cost.

(c) Extended Traffic Control. Traffic control required for an extended period of time due to the delay will be paid for according to Article 109.04.

When an extended traffic control adjustment is paid under this provision, an adjusted unit price as provided for in Article 701.20(a) for increase or decrease in the value of work by more than ten percent will not be paid.

Upon payment for a contract delay under this provision, the Contractor shall assign subrogation rights to the Department for the Department's efforts of recovery from any other party for monies paid by the Department as a result of any claim under this provision. The Contractor shall fully cooperate with the Department in its efforts to recover from another party any money paid to the Contractor for delay damages under this provision."

80384

HOT-MIX ASPHALT (BDE)

Effective: January 1, 2024

Revised: April 1, 2026

Add the following to the end of Article 406.06(c) of the Standard Specifications:

“The amount of HMA binder course placed shall be limited to that which can be surfaced during the same construction season.”

Revise the fifteenth through eighteenth paragraphs of Article 406.14 of the Standard Specifications to read:

“The mixture used in constructing acceptable HMA test strips will be paid for at the contract unit price. Unacceptable HMA test strips shall be removed and replaced at no additional cost to the Department.”

Revise the first and second paragraphs of Articles 1030.06(c)(2) of the Standard Specifications to read:

“(2) Personnel. The Contractor shall provide a QC Manager who shall have overall responsibility and authority for quality control. This individual shall maintain active certification as a Hot-Mix Asphalt Level II technician.

In addition to the QC Manager, the Contractor shall provide sufficient personnel to perform the required visual inspections, sampling, testing, and documentation in a timely manner. Mix designs shall be developed by personnel with an active certification as a Hot-Mix Asphalt Level III technician. Technicians performing mix design testing and plant sampling/testing shall maintain active certification as a Hot-Mix Asphalt Level I technician. The Contractor may provide a technician trainee who has successfully completed the Department’s “Hot-Mix Asphalt Trainee Course” to assist in the activities completed by a Hot-Mix Asphalt Level I technician for a period of one year after the course completion date. The Contractor may also provide a Gradation Technician who has successfully completed the Department’s “Gradation Technician Course” to run gradation tests only under the supervision of a Hot-Mix Asphalt Level II Technician. The Contractor shall provide a Hot-Mix Asphalt Density Tester who has successfully completed the Department’s “Nuclear Density Testing” course to run all nuclear density tests on the job site.”

Add Article 1030.06(d)(3) to the Standard Specifications as follows:

“(3) The Contractor shall take possession of any Department HMA mixture samples or density specimens upon notification by the Engineer. The Contractor shall collect the HMA mixture samples or density specimens from the location designated by the Engineer and may add these materials to RAP stockpiles according to Section 1031.”

Revise the second paragraph of Articles 1030.07(a)(11) and 1030.08(a)(9) of the Standard Specifications to read:

“When establishing the target density, the HMA maximum theoretical specific gravity (G_{mm}) will be based on the running average of four available Department test results for that project. If less than four G_{mm} test results are available, an average of all available Department test results for that project will be used. The initial G_{mm} will be the last available Department test result from a QMP project. If there is no available Department test result from a QMP project, the Department mix design verification test result will be used as the initial G_{mm} .”

Revise the Quality Control Limits table in Article 1030.09(c) to read:

“CONTROL LIMITS						
Parameter	IL-19.0, IL-9.5, IL-9.5FG, IL-19.0L, IL-9.5L		SMA-12.5, SMA-9.5		IL-4.75	
	Individual Test	Moving Avg. of 4	Individual Test	Moving Avg. of 4	Individual Test	Moving Avg. of 4
% Passing: ^{1/}						
1/2 in. (12.5 mm)	± 6 %	± 4 %	± 6 %	± 4 %		
3/8 in. (9.5mm)			± 4 %	± 3 %		
# 4 (4.75 mm)	± 5 %	± 4 %	± 5 %	± 4 %		
# 8 (2.36 mm)	± 5 %	± 3 %	± 4 %	± 2 %		
# 16 (1.18 mm)			± 4 %	± 2 %	± 4 %	± 3 %
# 30 (600 µm)	± 4 %	± 2.5 %	± 4 %	± 2.5 %		
Total Dust Content # 200 (75 µm)	± 1.5 %	± 1.0 %			± 1.5 %	± 1.0 %
Asphalt Binder Content	± 0.3 %	± 0.2 %	± 0.2 %	± 0.1 %	± 0.3 %	± 0.2 %
Air Voids ^{2/}	± 1.2 %	± 1.0 %	± 1.2 %	± 1.0 %	± 1.2 %	± 1.0 %
Field VMA ^{3/}	-0.7 %	-0.5 %	-0.7 %	-0.5 %	-0.7 %	-0.5 %

1/ Based on washed ignition oven or solvent extraction gradation.

2/ The air voids target value shall be 3.2 to 4.8 percent.

3/ Allowable limit below minimum design VMA requirement.”

Revise Article 1030.09(g)(1) of the Supplemental Specifications with the following:

“(1) The Contractor shall sample approximately 200 lb (91 kg) of mix as required for the Department’s random mixture verification tests according to Article 1030.09(h)(1).”

Revise Article 1030.09(g)(2) of the Standard Specifications to read:

“(2) The Contractor shall complete split verification sample tests listed in the Limits of Precision table in Article 1030.09(h)(1).”

Revise the second sentence of Article 1030.09(h)(1) of the Supplemental Specifications with the following:

“The random verification mixture sampling interval will be a maximum of 3,000 tons (2,720 metric tons). The Engineer will randomly identify one sample per interval, with a minimum of one sample per mix. If the remaining mix quantity is 600 tons (544 metric tons) or less, the quantity will be combined with the previous interval in the Engineer’s random sample identification. If the required tonnage of a mixture for a single pay item is less than 250 tons (225 metric tons) in total, the Engineer will waive mixture verification sampling and testing.”

Revise the third paragraph of Article 1030.09(h)(1) of the Standard Specifications to read:

“If comparisons of the mixture verification test results are outside the above limits of precision, the Department will verify the results by testing the retained split sample. The retest results will replace all the original results.”

In the Supplemental Specifications, replace the revision for the end of the third paragraph of Article 1030.09(h)(2) with the following:

“When establishing the target density, the HMA maximum theoretical specific gravity (G_{mm}) will be the Department mix design verification test result.”

Replace the last sentence of the fourth paragraph of Article 1030.10 of the Standard Specifications with the following:

“The mixture test results shall meet the requirements of Article 1030.05(d), except tensile strength and TSR testing will only be conducted on the first use of a mix design for the year and Hamburg wheel tests will only be conducted on High ESAL mixtures. To be considered acceptable to remain in place, the Department’s mixture test results shall meet the acceptable limits stated in Article 1030.09(i)(1). In addition, no visible pavement distress such as, but not limited to, segregation, excessive coarse aggregate fracturing outside of growth curves, excessive dust balls, or flushing shall be present as determined by the Engineer.”

Revise the tenth paragraph of Article 1030.10 of the Standard Specifications to read:

“Production is not required to stop after a test strip has been constructed.”

Replace the eleventh paragraph of Article 1030.10 of the Standard Specifications with the following:

“If an initial Hamburg wheel or I-FIT test fails to meet the requirements of Article 1030.05(d), the Department will verify the results by testing the retained gyratory cylinders. Upon notification by the Engineer of a Hamburg wheel or I-FIT test failure on the retained gyratory cylinders, the Contractor shall substitute an approved mix design, submit a new mix design for mix verification testing according to Article 1030.05(d), or pave 250 tons with or without an adjustment and resample for Department Hamburg wheel and I-FIT testing as directed by the Engineer. Paving may continue as long as all other mixture criteria is being met. If Hamburg wheel or I-FIT tests on the resampled HMA fail, production of the affected mixture shall cease and the Contractor shall substitute an approved mix design or submit a new mix design for mix verification testing according to Article 1030.05(d).”

80456

HOT-MIX ASPHALT – LONGITUDINAL JOINT SEALANT (BDE)

Effective: November 1, 2022

Revised: August 1, 2023

Add the following after the second sentence in the eighth paragraph of Article 406.06(h)(2) of the Standard Specifications:

“If rain is forecasted and traffic is to be on the LJS or if pickup/tracking of the LJS material is likely, the LJS shall be covered immediately following its application with FA 20 fine aggregate mechanically spread uniformly at a rate of 1.5 ± 0.5 lb/sq yd (0.75 ± 0.25 kg/sq m). Fine aggregate landing outside of the LJS shall be removed prior to application of tack coat.”

Add the following after the first sentence in the ninth paragraph of Article 406.06(h)(2) of the Standard Specifications:

“LJS half-width shall be applied at a width of 9 ± 1 in. (225 ± 25 mm) in the immediate lane to be placed with the outside edge flush with the joint of the next HMA lift. The vertical face of any longitudinal joint remaining in place shall also be coated.”

Add the following after the eleventh paragraph of Article 406.06(h)(2) of the Standard Specifications:

“LJS Half-Width Application Rate, lb/ft (kg/m) ^{1/}			
Lift Thickness, in. (mm)	Coarse Graded Mixture (IL-19.0, IL-19.0L, IL-9.5, IL-9.5L, IL-4.75)	Fine Graded Mixture (IL-9.5FG)	SMA Mixture (SMA-9.5, SMA-12.5)
$\frac{3}{4}$ (19)	0.44 (0.66)		
1 (25)	0.58 (0.86)		
1 $\frac{1}{4}$ (32)	0.66 (0.98)	0.44 (0.66)	
1 $\frac{1}{2}$ (38)	0.74 (1.10)	0.48 (0.71)	0.63 (0.94)
1 $\frac{3}{4}$ (44)	0.82 (1.22)	0.52 (0.77)	0.69 (1.03)
2 (50)	0.90 (1.34)	0.56 (0.83)	0.76 (1.13)
$\geq 2 \frac{1}{4}$ (60)	0.98 (1.46)		

1/ The application rate includes a surface demand for liquid. The thickness of the LJS may taper from the center of the application to a lesser thickness on the edge of the application, provided the correct width and application rate are maintained.”

Revise the second paragraph of Article 406.13(b) of the Standard Specifications to read:

“Aggregate for covering tack, LJS, or FLS will not be measured for payment.”

Add the following to the end of the second paragraph of Article 406.14 of the Standard Specifications:

“Longitudinal joint sealant (LJS) half-width will be paid for at the contract unit price per foot (meter) for LONGITUDINAL JOINT SEALANT, HALF-WIDTH.”

80446

PAVEMENT MARKING (BDE)

Effective: April 1, 2025

Revised: November 1, 2025

Revise the fourth sentence of the fourth paragraph of Article 780.05 of the Standard Specifications to read:

“Grooves for letters and symbols shall be cut in a rectangular shape or in the shape of the proposed marking so the entire marking will fit within the limits of the grooved area.”

Revise the last sentence of the third paragraph of Article 780.08 of the Standard Specifications to read:

“The Contractor shall install the preformed plastic pavement markings according to the manufacturer’s recommendations.”

Revise the second sentence of the first paragraph of Article 780.13 of the Standard Specifications to read:

“In addition, thermoplastic, preformed plastic, epoxy, preformed thermoplastic, polyurea, and modified urethane pavement markings will be inspected following a winter performance period that extends from November 15 to April 1 of the next year.”

80464

PERFORMANCE GRADED ASPHALT BINDER (BDE)

Effective: January 1, 2023

Revised: April 1, 2026

Revise Article 1032.05 of the Standard Specifications to read:

“1032.05 Performance Graded Asphalt Binder. These materials will be accepted according to the Bureau of Materials Policy Memorandum, “Performance Graded Asphalt Binder Qualification Procedure.” The Department will maintain a qualified producer list. These materials shall be free from water and shall not foam when heated to any temperature below the actual flash point. Air blown asphalt, recycle engine oil bottoms (ReOB), and polyphosphoric acid (PPA) modification shall not be used.

When requested, producers shall provide the Engineer with viscosity/temperature relationships for the performance graded asphalt binders delivered and incorporated in the work.

- (a) Performance Graded (PG) Asphalt Binder. The asphalt binder shall meet the requirements of AASHTO M 320, Table 1 “Standard Specification for Performance Graded Asphalt Binder” for the grade shown on the plans and the following.

Test	Parameter
Small Strain Parameter (AASHTO PP 113) BBR, ΔT_c , 40 hrs PAV (40 hrs continuous or 2 PAV at 20 hrs)	-5 °C min.

- (b) Modified Performance Graded (PG) Asphalt Binder. The asphalt binder shall meet the requirements of AASHTO M 320, Table 1 “Standard Specification for Performance Graded Asphalt Binder” for the grade shown on the plans.

Asphalt binder modification shall be performed at the source, as defined in the Bureau of Materials Policy Memorandum, “Performance Graded Asphalt Binder Qualification Procedure.”

Modified asphalt binder shall be safe to handle at asphalt binder production and storage temperatures or HMA construction temperatures. Safety Data Sheets (SDS) shall be provided for all asphalt modifiers.

- (1) Polymer Modification (SBS). Elastomers shall be added to the base asphalt binder to achieve the specified performance grade and shall be a styrene-butadiene-styrene without oil extension. The polymer modified asphalt binder shall be smooth, homogeneous, and be according to the following requirements for the grade shown on the plans.

Requirements for Styrene-Butadiene Copolymer (SBS) Modified Asphalt Binders			
Separation of Polymer ITP, "Separation of Polymer from Asphalt Binder" Difference in °F (°C) of the softening point between top and bottom portions		4 (2) max.	
Tests on Residue from Rolling Thin Film Oven Test (RTFO), AASHTO T 240			
Multiple Stress Creep Recovery (MSCR), AASHTO T 350			
Asphalt Grade	Test Temperature	Maximum J _{nr} (3.2 kPa)	Minimum % Recovery (3.2 kPa)
SBS 76-22	64 °C	≤ 0.5	≥ 75 %
SBS 70-22		≤ 2	≥ 30 %
SBS 76-28	58 °C	≤ 0.5	≥ 80 %
SBS 70-28		≤ 1	≥ 60 %
SBS 64-28		≤ 2	≥ 30 %

- (2) Ground Tire Rubber (GTR) Modification. GTR modification is the addition of recycled ground tire rubber to liquid asphalt binder to achieve the specified performance grade. GTR shall be produced from processing automobile and/or truck tires by the ambient grinding method or micronizing through a cryogenic process. GTR shall not exceed 1/16 in. (2 mm) in any dimension and shall not contain free metal particles, moisture that would cause foaming of the asphalt, or other foreign materials. A mineral powder (such as talc) meeting the requirements of AASHTO M 17 may be added, up to a maximum of four percent by weight of GTR to reduce sticking and caking of the GTR particles. When tested in accordance with Illinois Modified AASHTO T 27 "Standard Method of Test for Sieve Analysis of Fine and Coarse Aggregates" or AASHTO PP 74 "Standard Practice for Determination of Size and Shape of Glass Beads Used in Traffic Markings by Means of Computerized Optical Method", a 50 g sample of the GTR shall conform to the following gradation requirements.

Sieve Size	Percent Passing
No. 16 (1.18 mm)	100
No. 30 (600 µm)	95 ± 5
No. 50 (300 µm)	> 20

GTR modified asphalt binder shall be tested for rotational viscosity according to AASHTO T 316 using spindle S27. GTR modified asphalt binder shall be tested for original dynamic shear and RTFO dynamic shear according to AASHTO T 315 using a gap of 2 mm.

Requirements for Ground Tire Rubber (GTR) Modified Asphalt Binders		
TESTS ON RESIDUE FROM ROLLING THIN FILM OVEN TEST (AASHTO T 240)		
Elastic Recovery ASTM D 6084, Procedure A, 77 °F (25 °C), 100 mm elongation, %	60 min.	70 min.

- (3) Softener Modification (SM). Softener modification is the addition of organic compounds, such as engineered flux, bio-oil blends, modified vegetable oils, amines, and fatty acid derivatives, to the base asphalt binder to achieve the specified performance grade. Softeners shall be dissolved, dispersed, or reacted in the asphalt binder to enhance its performance and shall remain compatible with the asphalt binder with no separation. Softeners shall not be added to modified PG asphalt binder as defined in Article 1032.05(b)(2).

An Attenuated Total Reflectance-Fourier Transform Infrared spectrum (ATR-FTIR) shall be collected for both the softening compound as well as the softener modified asphalt binder at the dose intended for qualification. The ATR-FTIR spectra shall be collected on unaged softener modified binder, 20-hour Pressurized Aging Vessel (PAV) aged softener modified binder, and 40-hour PAV aged softener modified binder. The ATR-FTIR shall be collected in accordance with Illinois Test Procedure 601. The electronic files spectral files (in one of the following extensions or equivalent: *.SPA, *.SPG, *.IRD, *.IFG, *.CSV, *.SP, *.IRS, *.GAML, *. [0-9], *.IGM, *.ABS, *.DRT, *.SBM, *.RAS) shall be submitted to the Central Bureau of Materials.

Requirements for Softener Modified (SM) Asphalt Binders		
Test	Asphalt Grade	
		SM PG 46-28
	SM PG 52-28	SM PG 52-34
	SM PG 58-22	SM PG 58-28
	SM PG 64-22	
Small Strain Parameter (AASHTO PP 113) BBR, ΔT_c , 40 hrs PAV (40 hrs continuous or 2 PAV at 20 hrs)	-5 °C min.	
Large Strain Parameter (Illinois Modified AASHTO T 391) DSR/LAS Fatigue Property, $\Delta G^* _{peak}$, 40 hrs PAV (40 hrs continuous or 2 PAV at 20 hrs)	≥ 54 %	

- (4) Polymer/Softener Modification (SBS/SM). Polymer/Softener modification is the addition of organic compounds, such as engineered flux, bio-oil blends, modified vegetable oils, amines, and fatty acid derivatives, used in combination with SBS modified PG asphalt binder as modified in accordance with Article 1032.05(b)(1) to achieve the specified performance grade. Polymer/Softeners shall be compatible with

each other and dissolved, dispersed, or reacted in the asphalt binder to enhance its performance and shall remain compatible with the asphalt binder with no separation. Polymer/Softeners shall not be added to modified PG asphalt binder as defined in Article 1032.05(b)(2).

An Attenuated Total Reflectance-Fourier Transform Infrared spectrum (ATR-FTIR) shall be collected for both the polymer and the softening compound as well as the polymer/softener modified asphalt binder at the dose intended for qualification. The ATR-FTIR spectra shall be collected on unaged polymer/softener modified binder, 20-hour Pressurized Aging Vessel (PAV) aged polymer/softener modified binder, and 40-hour PAV aged polymer/softener modified binder. The ATR-FTIR shall be collected in accordance with Illinois Test Procedure 601. The electronic files spectral files (in one of the following extensions or equivalent: *.SPA, *.SPG, *.IRD, *.IFG, *.CSV, *.SP, *.IRS, *.GAML, *. [0-9], *.IGM, *.ABS, *.DRT, *.SBM, *.RAS) shall be submitted to the Central Bureau of Materials.

Requirements for Polymer/Softener Modified (SBS-SM) Asphalt Binders			
Separation of Polymer ITP, "Separation of Polymer from Asphalt Binder" Difference in °F (°C) of the softening point between top and bottom portions		4 (2) max.	
Tests on Residue from Rolling Thin Film Oven Test (RTFO), AASHTO T 240			
Multiple Stress Creep Recovery (MSCR), AASHTO T 350			
Asphalt Grade	Test Temperature	Maximum J_{nr} (3.2 kPa)	Minimum % Recovery (3.2 kPa)
SBS-SM 76-22	64 °C	≤ 0.5	≥ 75 %
SBS-SM 70-22		≤ 2	≥ 30 %
SBS-SM 76-28	58 °C	≤ 0.5	≥ 80 %
SBS-SM 70-28		≤ 1	≥ 60 %
SBS-SM 64-28		≤ 2	≥ 30 %
Small Strain Parameter (AASHTO PP 113) BBR, ΔT_c , 40 hrs PAV (40 hrs continuous or 2 PAV at 20 hrs)			-5 °C min.
Large Strain Parameter (Illinois Modified AASHTO T 391) DSR/LAS Fatigue Property, $\Delta G^* _{peak}$ τ , 40 hrs PAV (40 hrs continuous or 2 PAV at 20 hrs)			≥ 60 %

The following grades may be specified as tack coats.

Asphalt Grade	Use
PG 58-22, PG 58-28, PG 64-22	Tack Coat"

Revise Article 1031.06(c)(1) and 1031.06(c)(2) of the Standard Specifications to read:

“(1) RAP/RAS. When RAP is used alone or RAP is used in conjunction with RAS, the percentage of virgin ABR shall not exceed the amounts listed in the following table.

HMA Mixtures - RAP/RAS Maximum ABR % ^{1/ 2/}			
Ndesign	Binder	Surface	Polymer Modified Binder or Surface ^{3/}
30	30	30	10
50	25	15	10
70	15	10	10
90	10	10	10

1/ For Low ESAL HMA shoulder and stabilized subbase, the RAP/RAS ABR shall not exceed 50 percent of the mixture.

2/ When RAP/RAS ABR exceeds 20 percent, the high and low virgin asphalt binder grades shall each be reduced by one grade (i.e. 25 percent ABR would require a virgin asphalt binder grade of PG 64-22 to be reduced to a PG 58-28).

3/ The maximum ABR percentages for ground tire rubber (GTR) modified mixes shall be equivalent to the percentages specified for SBS polymer modified mixes.

(2) FRAP/RAS. When FRAP is used alone or FRAP is used in conjunction with RAS, the percentage of virgin asphalt binder replacement shall not exceed the amounts listed in the following table.

HMA Mixtures - FRAP/RAS Maximum ABR % ^{1/ 2/}			
Ndesign	Binder	Surface	Polymer Modified Binder or Surface ^{3/}
30	55	45	15
50	45	40	15
70	45	35	15
90	45	35	15
SMA	--	--	25
IL-4.75	--	--	35

1/ For Low ESAL HMA shoulder and stabilized subbase, the FRAP/RAS ABR shall not exceed 50 percent of the mixture.

2/ When FRAP/RAS ABR exceeds 20 percent for all mixes, the high and low virgin asphalt binder grades shall each be reduced by one grade (i.e. 25 percent ABR would require a virgin asphalt binder grade of PG 64-22 to be reduced to a PG 58-28).

- 3/ The maximum ABR percentages for GTR modified mixes shall be equivalent to the percentages specified for SBS polymer modified mixes.”

Add the following to the end of Note 2 of Article 1030.03 of the Standard Specifications.

“A dedicated storage tank for the ground tire rubber (GTR) modified asphalt binder shall be provided. This tank shall be capable of providing continuous mechanical mixing throughout and/or recirculation of the asphalt binder to provide a uniform mixture. The tank shall be heated and capable of maintaining the temperature of the asphalt binder at 300 °F to 350 °F (149 °C to 177 °C). The asphalt binder metering systems of dryer drum plants shall be calibrated with the actual GTR modified asphalt binder material with an accuracy of ± 0.40 percent.”

80441

REMOVAL AND DISPOSAL OF REGULATED SUBSTANCES (BDE)

Effective: January 1, 2024

Revised: April 1, 2026

Revise the first paragraph of Article 669.04 of the Standard Specifications to read:

“669.04 Regulated Substances Monitoring. Regulated substances monitoring includes environmental observation and field screening during regulated substances management activities. The excavated soil and groundwater within the work areas shall be managed as either uncontaminated soil, hazardous waste, special waste, or non-special waste.

As part of the regulated substances monitoring, the monitoring personnel shall perform and document the applicable duties listed on form BDE 2732 “Regulated Substances Monitoring Daily Record (RSM DR)”.

Revise the first two sentences of the nineteenth paragraph of Article 669.05 of the Standard Specifications to read:

“The Contractor shall coordinate waste disposal approvals with the disposal facility and provide the specific analytical testing requirements of that facility. The Contractor shall make all arrangements for collection, transportation, and analysis of landfill acceptance testing.”

Revise the last paragraph of Article 669.05 of the Standard Specifications to read:

“The Contractor shall select a permitted landfill facility or CCDD/USFO facility meeting the requirements of 35 Ill. Admin. Code Parts 810-814 or Part 1100, respectively. The Department will review and approve or reject the facility proposed by the Contractor based upon information provided in BDE 2730. The Contractor shall verify whether the selected facility is compliant with those applicable standards as mandated by their permit and whether the facility is presently, has previously been, or has never been, on the United States Environmental Protection Agency (U.S. EPA) National Priorities List or the Resource Conservation and Recovery Act (RCRA) List of Violating Facilities. The use of a Contractor selected facility shall in no manner delay the construction schedule or alter the Contractor's responsibilities as set forth.”

Revise the first paragraph of Article 669.07 of the Standard Specifications to read:

“669.07 Temporary Staging. Soil classified according to Articles 669.05(a)(2), (b)(1), or (c) may be temporarily staged at the Contractor's option. All other soil classified according to Articles 669.05(a)(1), (a)(3), (a)(4), (a)(5), (a)(6), or (b)(2) shall be managed and disposed of without temporary staging to the greatest extent practicable. If circumstances beyond the Contractor's control require temporary staging of these latter materials, the Contractor shall request approval from the Engineer in writing.

Topsoil for re-use as final cover which has been field screened and found not to exhibit PID readings over daily background readings as documented on the BDE 2732, visual staining or

odors, and is classified according to Articles 669.05(a)(2), (a)(3), (a)(4), (b)(1), or (c) may be temporarily staged at the Contractor's option."

Add the following paragraph after the fourth paragraph of Article 669.10 of the Standard Specifications.

"Regulated substances monitoring will be measured for payment per calendar day, where 4 or more hours of monitoring activities is defined as 1.0 calendar day and less than 4 hours of monitoring activities is defined as 0.5 calendar day."

Revise the second paragraph of Article 669.11 of the Standard Specification to read:

"Regulated substances monitoring, including completion of form BDE 2732 for each day of work, will be paid for at the contract unit price per calendar day for REGULATED SUBSTANCES MONITORING. In no case will more than 1.0 calendar day be paid on a given calendar day."

Add the following paragraph after the sixth paragraph of Article 669.11 of the Standard Specifications.

"The sampling and testing of effluent water derived from dewatering discharges for priority pollutants volatile organic compounds (VOCs), priority pollutants semi-volatile organic compounds (SVOCs), or priority pollutants metals, will be paid for at the contract unit price per each for VOCS GROUNDWATER ANALYSIS using EPA Method 8260B, SVOCs GROUNDWATER ANALYSIS using EPA Method 8270C, or RCRA METALS GROUNDWATER ANALYSIS using EPA Methods 6010B and 7471A. This price shall include transporting the sample from the job site to the laboratory."

Revise the first sentence of the eight paragraph of Article 669.11 of the Standard Specifications to read:

"Payment for temporary staging of soil classified according to Articles 669.05(a)(1), (a)(3), (a)(4), (a)(5), (a)(6), or (b)(2) to be managed and disposed of, if required and approved by the Engineer, will be paid according to Article 109.04."

80455

SHORT TERM AND TEMPORARY PAVEMENT MARKINGS (BDE)

Effective: April 1, 2024

Revised: April 2, 2024

Revise Article 701.02(d) of the Standard Specifications to read:

“(d) Pavement Marking Tapes (Note 3) 1095.06”

Add the following Note to the end of Article 701.02 of the Standard Specifications:

“Note 3. White or yellow pavement marking tape that is to remain in place longer than 14 days shall be Type IV tape.”

Revise Article 703.02(c) of the Standard Specifications to read:

“(c) Pavement Marking Tapes (Note 1) 1095.06”

Add the following Note to the end of Article 703.02 of the Standard Specifications:

“Note 1. White or yellow pavement marking tape that is to remain in place longer than 14 days shall be Type IV tape.”

Revise Article 1095.06 of the Standard Specifications to read:

“1095.06 Pavement Marking Tapes. Type I white or yellow marking tape shall consist of glass spheres embedded into a binder on a foil backing that is precoated with a pressure sensitive adhesive. The spheres shall be of uniform gradation and distributed evenly over the surface of the tape.

Type IV tape shall consist of white or yellow tape with wet reflective media incorporated to provide immediate and continuing retroreflection in wet and dry conditions. The wet retroreflective media shall be bonded to a durable polyurethane surface. The patterned surface shall have approximately 40 ± 10 percent of the surface area raised and presenting a near vertical face to traffic from any direction. The channels between the raised areas shall be substantially free of exposed reflective elements or particles.

Blackout tape shall consist of a matte black, non-reflective, patterned surface that is precoated with a pressure sensitive adhesive.

- (a) Color. The white and yellow markings shall meet the following requirements for daylight reflectance and color, when tested, using a color spectrophotometer with 45 degrees circumferential/zero degree geometry, illuminant D65, and two degree observer angle. The color instrument shall measure the visible spectrum from 380 to 720 nm with a wavelength measurement interval and spectral bandpass of 10 nm.

Color	Daylight Reflectance %Y
White	65 min.
Yellow *	36 - 59

*Shall match Aerospace Material Specification Standard 595 33538 (Orange Yellow) and the chromaticity limits as follows.

x	0.490	0.475	0.485	0.530
y	0.470	0.438	0.425	0.456

- (b) Retroreflectivity. The white and yellow markings shall be retroreflective. Reflective values measured in accordance with the photometric testing procedure of ASTM D 4061 shall not be less than those listed in the table below. The coefficient of retroreflected luminance, R_L , shall be expressed as average millicandelas/footcandle/sq ft (millicandelas/lux/sq m), measured on a 3.0 x 0.5 ft (900 mm x 150 mm) panel at 86 degree entrance angle.

Coefficient of Retroreflected Luminance, R_L , Dry					
Type I			Type IV		
Observation Angle	White	Yellow	Observation Angle	White	Yellow
0.2°	2700	2400	0.2°	1300	1200
0.5°	2250	2000	0.5°	1100	1000

Wet retroreflectance shall be measured for Type IV under wet conditions according to ASTM E 2177 and meet the following.

Wet Retroreflectance, Initial R_L	
Color	R_L 1.05/88.76
White	300
Yellow	200

- (c) Skid Resistance. The surface of Type IV and blackout markings shall provide a minimum skid resistance of 45 BPN when tested according to ASTM E 303.
- (d) Application. The pavement marking tape shall have a precoated pressure sensitive adhesive and shall require no activation procedures. Test pieces of the tape shall be applied according to the manufacturer's instructions and tested according to ASTM D 1000, Method A, except that a stiff, short bristle roller brush and heavy hand pressure will be substituted for the weighted rubber roller in applying the test pieces to the metal test panel. Material tested as directed above shall show a minimum adhesion value of 750 g/in. (30 g/mm) width at the temperatures specified in ASTM D 1000. The adhesive shall be resistant to oils, acids, solvents, and water, and shall not leave objectionable stains or residue after removal. The material shall be flexible and conformable to the texture of the pavement.

(e) Durability. Type IV and blackout tape shall be capable of performing for the duration of a normal construction season and shall then be capable of being removed intact or in large sections at pavement temperatures above 40 °F (4 °C) either manually or with a roll-up device without the use of sandblasting, solvents, or grinding. The Contractor shall provide a manufacturer's certification that the material meets the requirements for being removed after the following minimum traffic exposure based on transverse test decks with rolling traffic.

- (1) Time in place - 400 days
- (2) ADT per lane - 9,000 (28 percent trucks)
- (3) Axle hits - 10,000,000 minimum

Samples of the material applied to standard specimen plates will be measured for thickness and tested for durability in accordance with ASTM D 4060, using a CS-17 wheel and 1000-gram load, and shall meet the following criteria showing no significant change in color after being tested for the number of cycles indicated.

Test	Type I	Type IV	Blackout
Minimum Initial Thickness, mils (mm)	20 (0.51)	65 (1.65) ^{1/} 20 (0.51) ^{2/}	65 (1.65) ^{1/} 20 (0.51) ^{2/}
Durability (cycles)	5,000	1,500	1,500

1/ Measured at the thickest point of the patterned surface.

2/ Measured at the thinnest point of the patterned surface.

The pavement marking tape, when applied according to the manufacturer's recommended procedures, shall be weather resistant and shall show no appreciable fading, lifting, or shrinkage during the useful life of the marking. The tape, as applied, shall be of good appearance, free of cracks, and edges shall be true, straight, and unbroken.

(f) Sampling and Inspection.

(1) Sample. Prior to approval and use of Type IV pavement marking tape, the manufacturer shall submit a notarized certification from an independent laboratory, together with the results of all tests, stating that the material meets the requirements as set forth herein. The independent laboratory test report shall state the lot tested, the manufacturer's name, and the date of manufacture.

After initial approval by the Department, samples and certification by the manufacturer shall be submitted for each subsequent batch of Type IV tape used. The manufacturer shall submit a certification stating that the material meets the requirements as set forth herein and is essentially identical to the material sent for qualification. The certification shall state the lot tested, the manufacturer's name, and the date of manufacture.

(2) Inspection. The Contractor shall provide a manufacturer's certification to the Engineer stating the material meets all requirements of this specification. All material samples for acceptance tests shall be taken or witnessed by a representative of the Bureau of Materials and shall be submitted to the Engineer of Materials, 126 East Ash Street, Springfield, Illinois 62704-4766 at least 30 days in advance of the pavement marking operations."

80457

SOURCE OF SUPPLY AND QUALITY REQUIREMENTS (BDE)

Effective: January 2, 2023

Revised: January 1, 2026

Revise the third through ninth paragraphs of Article 106.01 of the Standard Specifications to read:

“Articles, materials, and supplies shall be classified into only one of the following categories.

- (a) Iron and Steel. All iron and steel products, which are to be incorporated into the work, shall be domestically manufactured or produced and fabricated, unless an exception is expressly permitted under Federal and/or State law and written permission is given by the Department. The Contractor shall obtain from the iron or steel producer and/or fabricator, in addition to the mill analysis, a certification that all iron or steel materials meet these domestic source requirements.

The applications of all coatings, epoxy, galvanizing, painting, etc. to iron and steel products shall be domestically applied.

- (b) Manufactured Products. Manufactured products shall include articles, materials or supplies that have been processed into a specific form or shape; or have been combined with other articles, materials, or supplies to create a product with different properties than the individual articles, materials, or supplies. Manufactured products incorporated into the work shall have the final assembly for the manufacturing process occur domestically.

A manufactured product may include components that are construction materials, iron or steel products, or exempt materials.

Precast concrete products and intelligent transportation systems (ITS) or other electronic hardware systems shall comply with the requirements of Article 106.01(a) in addition to the requirements of manufactured products.

- (c) Construction Materials. All manufacturing processes for construction materials shall occur within the United States. Construction materials shall include an article, material, or supply consisting of only one of the following.

(1) Non-ferrous metals;

(2) Plastic and polymer-based products (including polyvinylchloride, composite building materials, and polymers used in fiber optic cables);

(3) Glass (including optic glass);

(4) Fiber optic cable (including drop cable);

(5) Optical fiber;

(6) Lumber;

(7) Drywall;

(8) Engineered wood.

Minor additions of articles, materials, supplies, or binding agents to a construction material do not change the categorization of the construction material.

(d) Exempt Materials. Materials exempt from domestic production requirements are cement or cementitious materials, aggregates, aggregate binding agents or additives, or items not permanently incorporated into the work. Exempt materials may be combined with other materials into a final form to produce a manufactured product.”

80448

SUBCONTRACTOR AND DBE PAYMENT REPORTING (BDE)

Effective: April 2, 2018

Add the following to Section 109 of the Standard Specifications.

“109.14 Subcontractor and Disadvantaged Business Enterprise Payment Reporting.
The Contractor shall report all payments made to the following parties:

- (a) first tier subcontractors;
- (b) lower tier subcontractors affecting disadvantaged business enterprise (DBE) goal credit;
- (c) material suppliers or trucking firms that are part of the Contractor’s submitted DBE utilization plan.

The report shall be made through the Department’s on-line subcontractor payment reporting system within 21 days of making the payment.”

80397

SUBCONTRACTOR MOBILIZATION PAYMENTS (BDE)

Effective: November 2, 2017

Revised: April 1, 2019

Replace the second paragraph of Article 109.12 of the Standard Specifications with the following:

“This mobilization payment shall be made at least seven days prior to the subcontractor starting work. The amount paid shall be at the following percentage of the amount of the subcontract reported on form BC 260A submitted for the approval of the subcontractor’s work.

Value of Subcontract Reported on Form BC 260A	Mobilization Percentage
Less than \$10,000	25%
\$10,000 to less than \$20,000	20%
\$20,000 to less than \$40,000	18%
\$40,000 to less than \$60,000	16%
\$60,000 to less than \$80,000	14%
\$80,000 to less than \$100,000	12%
\$100,000 to less than \$250,000	10%
\$250,000 to less than \$500,000	9%
\$500,000 to \$750,000	8%
Over \$750,000	7%”

80391

SUBMISSION OF BIDDERS LIST INFORMATION (BDE)

Effective: January 2, 2025

Revised: March 2, 2025

In accordance with 49 CFR 26.11(c) all DBE and non-DBEs who bid as prime contractors and subcontractors shall provide bidders list information, including all DBE and non-DBE firms from whom the bidder has received a quote or bid to work as a subcontractor, whether or not the bidder has relied upon that bid in placing its bid as the prime contractor.

The bidders list information shall be submitted with the bid using the link provided within the “Integrated Contractor Exchange (iCX)” application of the Department’s “EBids System”.

80463

SUBMISSION OF PAYROLL RECORDS – FEDERAL AID CONTRACT (BDE)

Effective: April 1, 2026

If the prevailing rate of wages published by the Illinois Department of Labor (IDOL) is equal to or greater than the prevailing wage determination by the United States Secretary of Labor for the same locality for the same type of construction used to classify the federal construction project, the requirements of the Illinois Prevailing Wage Act (820 ILCS 130) shall apply, including the “ILLINOIS PREVAILING WAGE ACT” section below. If not, only the requirements of the Davis-Bacon Act shall apply, including the “DAVIS-BACON ACT” section below.

DAVIS-BACON ACT. Revise the following section of Check Sheet #1 of the Recurring Special Provisions to read:

“STATEMENTS AND PAYROLLS

The payroll records shall include the worker’s name, social security number, last known address, telephone number, email address, classification(s) of work actually performed, hourly rates of wages paid (including rates of contributions or costs anticipated for bona fide fringe benefits or cash equivalents thereof), daily and weekly number of hours actually worked in total, deductions made, and actual wages paid.

The Contractor and each subcontractor shall submit certified payroll records to the Department each week from the start to the completion of their respective work, except that full social security numbers, last known addresses, telephone numbers, and email addresses shall not be included on weekly submittals. Instead, the payrolls need only include an identification number for each employee (e.g., the last four digits of the employee’s social security number). The submittals shall be made using LCPTracker Pro software. The software is web-based and can be accessed at <https://lcptracker.com/>. When there has been no activity during a work week, a payroll record shall still be submitted with the appropriate option (“No Work”, “Suspended”, or “Complete”) selected.”

ILLINOIS PREVAILING WAGE ACT. Revise the following section of Check Sheet #1 of the Recurring Special Provisions to read:

“STATEMENTS AND PAYROLLS

- (1) Prevailing Wages. All wages paid by the Contractor and each subcontractor shall be in compliance with The Prevailing Wage Act (820 ILCS 130), as amended, except where a prevailing wage violates a federal law, order, or ruling, the rate conforming to the federal law, order, or ruling shall govern. The Contractor shall be responsible to notify each subcontractor of the wage rates set forth in this contract and any revisions thereto. If the Department of Labor revises the wage rates, the Contractor will not be allowed additional compensation on account of said revisions.

- (2) Payroll Records. The Contractor and each subcontractor shall make and keep, for a period of five years from the later of the date of final payment under the contract or completion of the contract, records of the wages paid to his/her workers. The payroll records shall include the worker's name, the worker's address, the worker's telephone number when available, the worker's social security number, the worker's classification or classifications, the worker's gross and net wages paid in each pay period, the worker's number of hours worked each day, and the worker's starting and ending times of work each day. However, any Contractor or subcontractor who remits contributions to a fringe benefit fund that is not jointly maintained and jointly governed by one or more employer and one or more labor organization must additionally submit the worker's hourly wage rate, the worker's hourly overtime wage rate, the worker's hourly fringe benefit rates, the name and address of each fringe benefit fund, the plan sponsor of each fringe benefit, if applicable, and the plan administrator of each fringe benefit, if applicable. Upon seven business days' notice, these records shall be available at a location within the State, during reasonable hours, for inspection by the Department or the Department of Labor; and Federal, State, or local law enforcement agencies and prosecutors.
- (3) Submission of Payroll Records. The Contractor and each subcontractor shall, no later than the 15th day of each calendar month, file a certified payroll for the immediately preceding month to the Illinois Department of Labor (IDOL) through the Certified Transcript of Payroll Portal in compliance with the State Prevailing Wage Act (820 ILCS 130). The portal can be found on the IDOL website at <https://labor.illinois.gov>. Payrolls shall be submitted in the format prescribed by the IDOL.

In addition to filing certified payroll(s) with the IDOL, the Contractor and each subcontractor shall certify and submit payroll records to the Department each week from the start to the completion of their respective work, except that full social security numbers shall not be included on weekly submittals. Instead, the payrolls shall include an identification number for each employee (e.g., the last four digits of the employee's social security number). In addition, starting and ending times of work each day may be omitted from the payroll records submitted. The submittals shall be made using LCPtracker Pro software. The software is web-based and can be accessed at <https://lcptracker.com/>. When there has been no activity during a work week, a payroll record shall still be submitted with the appropriate option ("No Work", "Suspended", or "Complete") selected.

- (4) Employee Interviews. The Contractor and each subcontractor shall permit his/her employees to be interviewed on the job, during working hours, by compliance investigators of the Department or the Department of Labor."

80482

SURVEYING SERVICES (BDE)

Effective: April 1, 2025

Delete the fourth paragraph of Article 667.04 of the Standard Specifications.

Delete Section 668 of the Standard Specifications.

80465

VEHICLE AND EQUIPMENT WARNING LIGHTS (BDE)

Effective: November 1, 2021

Revised: November 1, 2022

Add the following paragraph after the first paragraph of Article 701.08 of the Standard Specifications:

“The Contractor shall equip all vehicles and equipment with high-intensity oscillating, rotating, or flashing, amber or amber-and-white, warning lights which are visible from all directions. In accordance with 625 ILCS 5/12-215, the lights may only be in operation while the vehicle or equipment is engaged in construction operations.”

80439

WORKING DAYS (BDE)

Effective: January 1, 2002

The Contractor shall complete the work within **45** working days.

80071

STATE OF ILLINOIS
DEPARTMENT OF TRANSPORTATION
 PLANS FOR PROPOSED IMPROVEMENT
 FAS 882 (CH 10) BLAIRSVILLE ROAD
 SECTION NUMBER: 23-00119-00-RS
 PROJECT NUMBER: GQH(960)
 JOB NUMBER: C-99-021-25
 CONTRACT NUMBER: 99772
 HAMILTON COUNTY

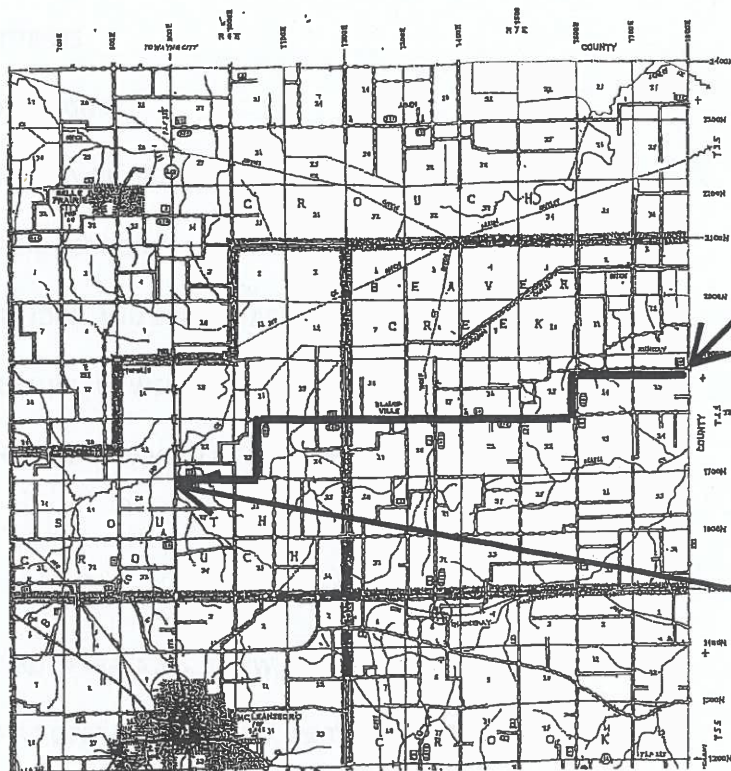
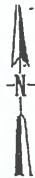

PROPOSED IMPROVEMENT
 ENDS AT STATION 567+60

PROPOSED IMPROVEMENT
 BEGINS AT STATION 0+00

TOWNSHIPS:
 South Crouch - R. 6 E. / T. 4 S.
 Beaver Creek - R. 7 E. / T. 4 S.



CLASSIFICATION:
 RURAL MAJOR COLLECTOR
 ADT = 1500

TOTAL LENGTH= 56,760 FT
 NET LENGTH OF IMPROVEMENT= 56,760 FT (10.75 MILES)

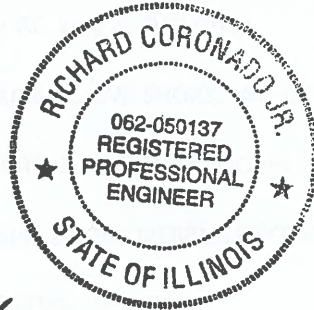

Richard Coronado Jr.
 RICHARD CORONADO JR.
 Professional Engineer
 #062-050137
 Expires 11/30/2025

APPROVED: 03/24/2026

Richard Coronado Jr.
 HAMILTON COUNTY ENGINEER

PASSED: 4-1-26

[Signature]
 DISTRICT 9 LOCAL ROADS & STREETS

Released for Bid Based on Limited Review

DATE: 4-1-26

[Signature]
 IDOT REGION 5 ENGINEER

CONTENTS

SHEET #	TITLE
1	COVER SHEET
2	CONTENTS
3	MIX DESIGNS
4	SUMMARY OF QUANTITIES
5	TYPICAL SECTIONS
6	BUTT JOINT AND BINDER TAPER DETAILS
7	HMA SURFACE WEDGE DETAILS
8	SCHEDULE OF PAVEMENT MARKINGS

STANDARD #	DESCRIPTION
701001-02	OFF-RD OPERATIONS, 2L, 2W, MORE THAN 15' FROM EOP
701006-05	OFF-RD OPERATIONS, 2L, 2W, 15' TO 24" FROM EOP
701011-04	OFF-RD MOVING OPERATIONS, 2L, 2W, DAY ONLY
701201-05	LANE CLOSURE, 2L, 2W, DAY ONLY
701301-04	LANE CLOSURE, 2L, 2W, SHORT TIME OPERATIONS
701306-04	LANE CLOSURE, 2L, 2W, SLOW MOVING OPERATIONS DAY ONLY
701311-03	LANE CLOSURE 2L, 2W, MOVING OPERATIONS - DAY ONLY
701901-11	TRAFFIC CONTROL DEVICES
780001-05	TYPICAL PAVEMENT MARKINGS

Locations	Hot-Mix Asphalt Surface Course
Mixture Use(s):	Hot-Mix Asphalt Surface Course, Mix C, N50
PG:	PG64-22
Design Air Voids:	4.0 %, 50 Gyration Design
Mixture Composition: (Gradation Mixture)	IL-9.5mm
Friction Aggregate:	Mix C
Mixture Weight:	112 lbs/Sq Yd/in
Quality Management Program:	QC/QA
Sublot Size:	3000
Material Thickness	1 ½"

Locations	Hot-Mix Asphalt Binder Course
Mixture Use(s):	Hot-Mix Asphalt Binder Course, IL-9.5FG, N70
PG:	PG64-22
Design Air Voids:	4.0 %, 70 Gyration Design
Mixture Composition: (Gradation Mixture)	IL-9.5mm Fine Grade
Friction Aggregate:	None
Mixture Weight:	112 lbs/Sq Yd/in
Quality Management Program:	QCQA
Sublot Size:	1000
Material Thickness	1 ¼"

SUMMARY OF QUANTITIES

<u>PAY ITEM NUMBER</u>	<u>ITEM</u>	<u>UJNT</u>	<u>QUANTITY</u>
40600290	BITUMINOUS MATERIALS (TACK COAT)	POUND	86000
40600370	LONGITUDINAL JOINT SEAL	FOOT	56760
40600982	HMA SURFACE REMOVAL - BUTT JOINT	SQ YD	889
40600990	TEMPORARY RAMP	SQ YD	89
40602970	HMA BINDER COURSE, IL-9.5FG, N70	TON	9100
40604050	HMA SURFACE COURSE, IL-9.5, MIX 'C', N50	TON	11350
44000151	HMA SURFACE REMOVAL 1/2"	SQ YD	125250
48101200	AGGREGATE SHOULDERS, TYPE B	TON	5950
67100100	MOBILIZATION	L SUM	1
70300100	SHORT TERM PAVEMENT MARKING	FOOT	11352
70300150	SHORT TERM PAVEMENT MARKING REMOVAL	SQ FT	3746
* 78001110	PAINT PAVEMENT MARKING - LINE 4"	FOOT	153500
X7010216	TRAFFIC CONTROL AND PROTECTION, (SPECIAL)	L SUM	1

* SPECIALTY ITEM

TYPICAL SECTION

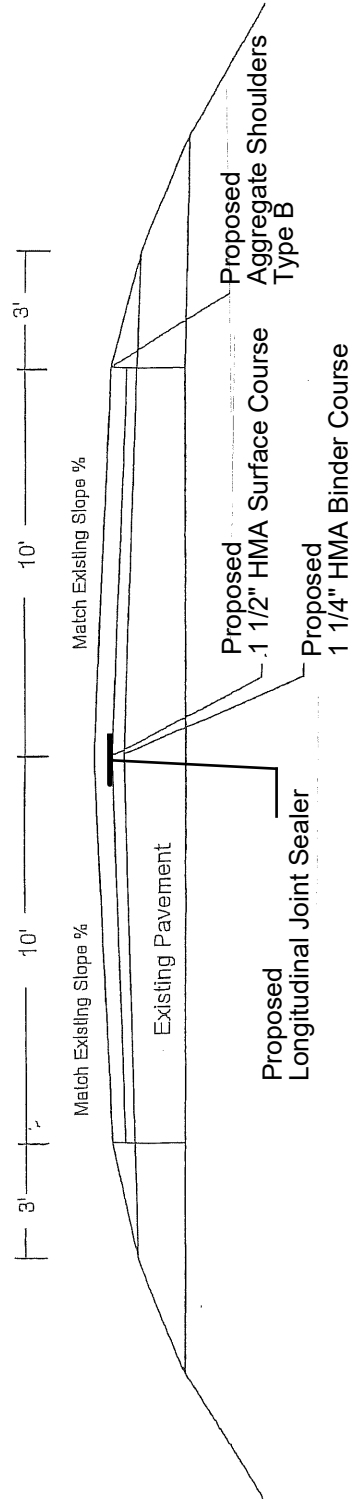

Station 0+00 to 567+60

BUTT JOINT (TYP.)

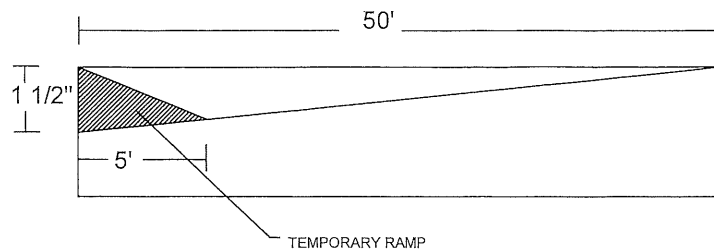

- Station 0+00
- Station 93+94
- Station 94+26
- Station 238+38
- Station 238+86
- Station 396+87
- Station 397+21
- Station 567+60

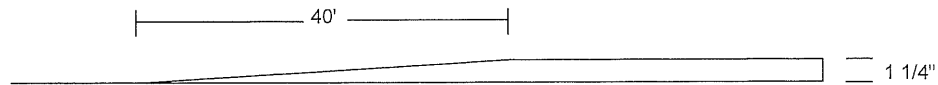

HMA BINDER TAPER

- Station 0+50
- Station 93+44
- Station 94+76
- Station 237+88
- Station 239+36
- Station 396+37
- Station 397+71
- Station 567+10

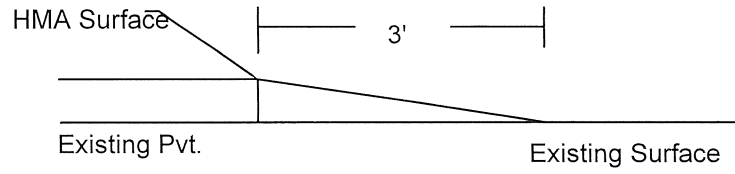

SECTION A-A

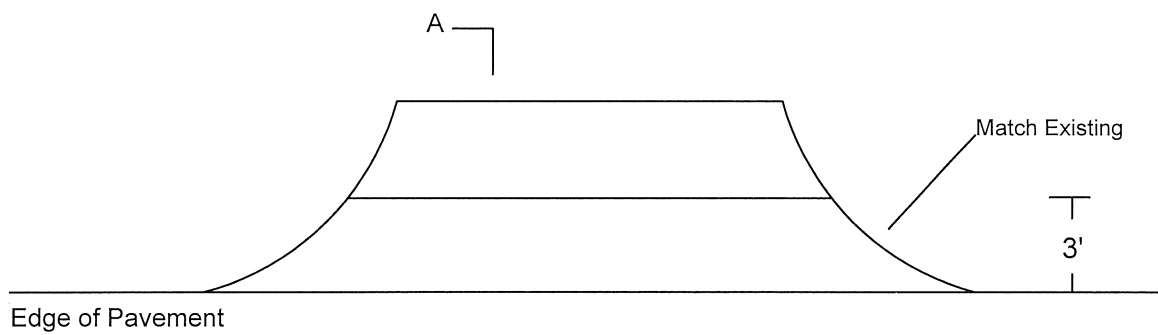

TYPICAL SIDE ROAD and ENTRANCE DETAILS

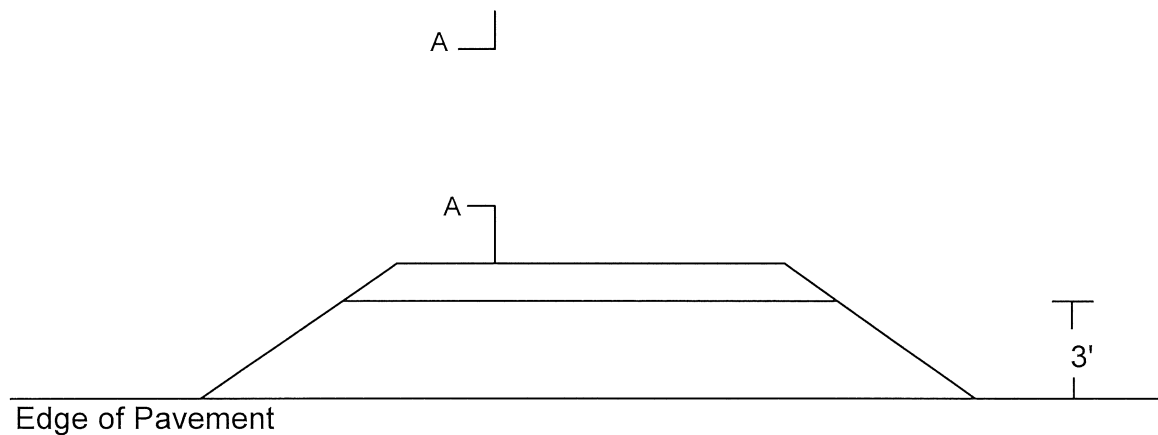

TYPICAL MAIL BOX TURNOUT

HMA SURFACE WEDGE DETAILS

SCHEDULE OF PAVEMENT MARKINGS

YELLOW				
STATION	STATION	LENGTH	DESCRIPTION	QUANTITY
0+00	50+00	5000	C/L Skips	1250
50+00	55+37	537	EB NPZ	537
50+00	63+50	1350	WB NPZ	1350
55+35	72+65	1730	C/L Skips	430
64+30	80+50	1620	EB NPZ	1620
72+65	89+40	1675	WB NPZ	1675
80+50	123+20	4270	C/L Skips	1070
89+40	94+88	548	EB NPZ	548
96+95	103+40	645	WB NPZ	645
114+22	139+00	2478	EB NPZ	2478
123+20	139+00	1580	WB NPZ	1580
139+00	416+00	27700	C/L Skips	6930
369+31	374+11	480	EB NPZ	480
378+29	382+66	437	WB NPZ	437
408+00	459+25	5125	EB NPZ	5125
416+00	472+10	5610	WB NPZ	5610
459+20	499+00	3980	C/L Skips	1000
484+15	501+50	1735	EB NPZ	1735
499+00	513+92	1492	WB NPZ	1492
501+50	507+50	600	C/L Skips	150
507+50	530+00	2250	EB NPZ	2250
513+90	519+50	560	C/L Skips	140
519+50	543+20	2370	WB NPZ	2370
530+00	567+60	3760	C/L Skips	940
Total Yellow				41842

WHITE		
	EB EOP	WB EOP
Side Roads		
1000 E	65	
1700 N	75	
1050 E		85
1150 E	60	65
1200 E	60	60
1225 E		60
1275 E	50	
1300 E	65	45
1350 E	80	50
1400 E	60	75
1450 E	35	60
1500 E	70	65
1550 E	35	
Miller	150	
Miller	60	
1600 E		90
1600 E		75
1650 E		55
1700 E	60	95
1800 E		70
	925	950
TOTAL =		55835 55810
Total White		111645

GRAND TOTAL 153487

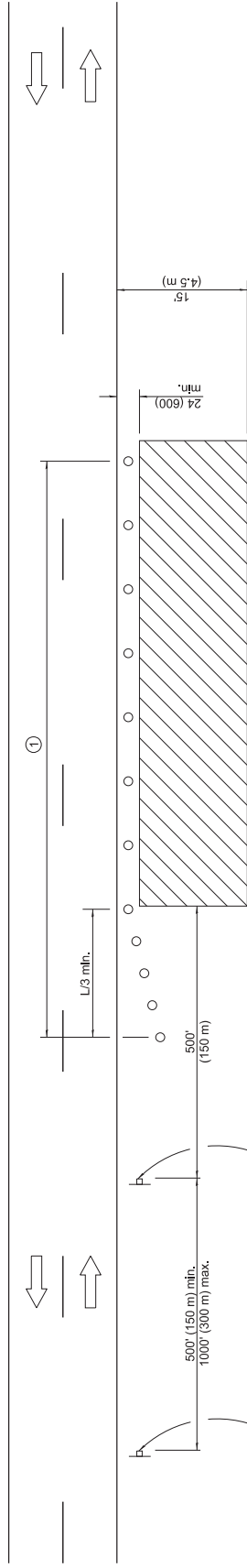

For contract construction projects

W20-103(0)-48

For maintenance and utility projects

W2D-1(0)-48

W21-1(0)-48

TYPICAL APPLICATIONS

- Utility operations
- Culvert extensions
- Site slope changes
- Guardrail installation and maintenance
- Delineator installation
- Landscaping operations
- Shoulder repair
- Sign installation and maintenance

① When the work operation exceeds one hour, cones, drums or barricades shall be placed at 25' (8 m) centers for $L/3$ distance, and at 50' (15 m) centers through the remainder of the work area.

SYMBOLS

- Work area
- Sign
- Cone, drum or barricade

GENERAL NOTES

This Standard is used where any vehicles, equipment, workers or their activities will encroach in the area 15' (4.5 m) to 24' (600) from the edge of pavement.

Calculate L as follows:

SPEED LIMIT	FORMULAS	(Metric)
40 mph (70 km/h) or less:	$L = \frac{WS^2}{60}$	English
45 mph (80 km/h) or greater:	$L = \frac{WS^2}{80}$	English
	$L = 0.65(W)(S)$	Metric

W = Width of offset in feet (meters).
 S = Normal posted speed mph (km/h).

All dimensions are in inches (millimeters) unless otherwise shown.

DATE	REVISIONS
1-1-14	Revised workers sign number to agree with current MUTCD.
1-1-13	Omitted text "WORKERS' sign."

OFF-RD OPERATIONS, 2L, 2W, 15' (4.5 m) TO 24" (600 mm) FROM PAVEMENT EDGE

STANDARD 701006-05

Illinois Department of Transportation

APPROVED: January 1, 2014
 ENGINEER OF SAFETY ENGINEERING

APPROVED: January 1, 2014
 ENGINEER OF DESIGN AND ENVIRONMENT

ISSUED 1-1-87

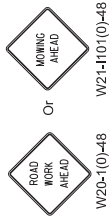

Or



W21-1(0)-48



W20-103(0)-48

500' (150 m) min.
1000' (300 m) max.

Varies ①



15'
(4.5 m)

Varies ①

500' (150 m) min.
1000' (300 m) max.

For contract construction projects



W20-103(0)-48

For maintenance and utility projects



W21-1(0)-48

TYPICAL APPLICATIONS

Shoulder work
Utility operations

① Minimum distance is 200' (60 m). Maximum distance to be determined by the Engineer but should not exceed 1/2 the length required for one normal working day's operation, or 4 miles (6.4 Km) whichever is less.

SYMBOLS



Work area



Sign



Flagger with traffic control sign when required

GENERAL NOTES

This Standard is used where at any time, any vehicle, equipment, workers or their activities require an intermittent or continuous moving operation on the shoulder, where the average speed is 1 mph (2 km/h) or less.

When the work operation does not exceed 60 minutes, traffic control may be according to Standard 701301.

All dimensions are in inches (millimeters) unless otherwise shown.

**OFF-RD MOVING OPERATIONS
2L, 2W, DAY ONLY**

DATE	REVISIONS
1-1-14	Revised workers sign number to agree with current MUTCD.
1-1-13	Omitted text "WORKERS' sign."

STANDARD 701011-04

Illinois Department of Transportation
 APPROVED: [Signature] JANUARY 1, 2014
 ENGINEER OF SAFETY ENGINEERING
 APPROVED: [Signature] JANUARY 1, 2014
 ENGINEER OF DESIGN AND ENVIRONMENT
 ISSUED 1-1-97

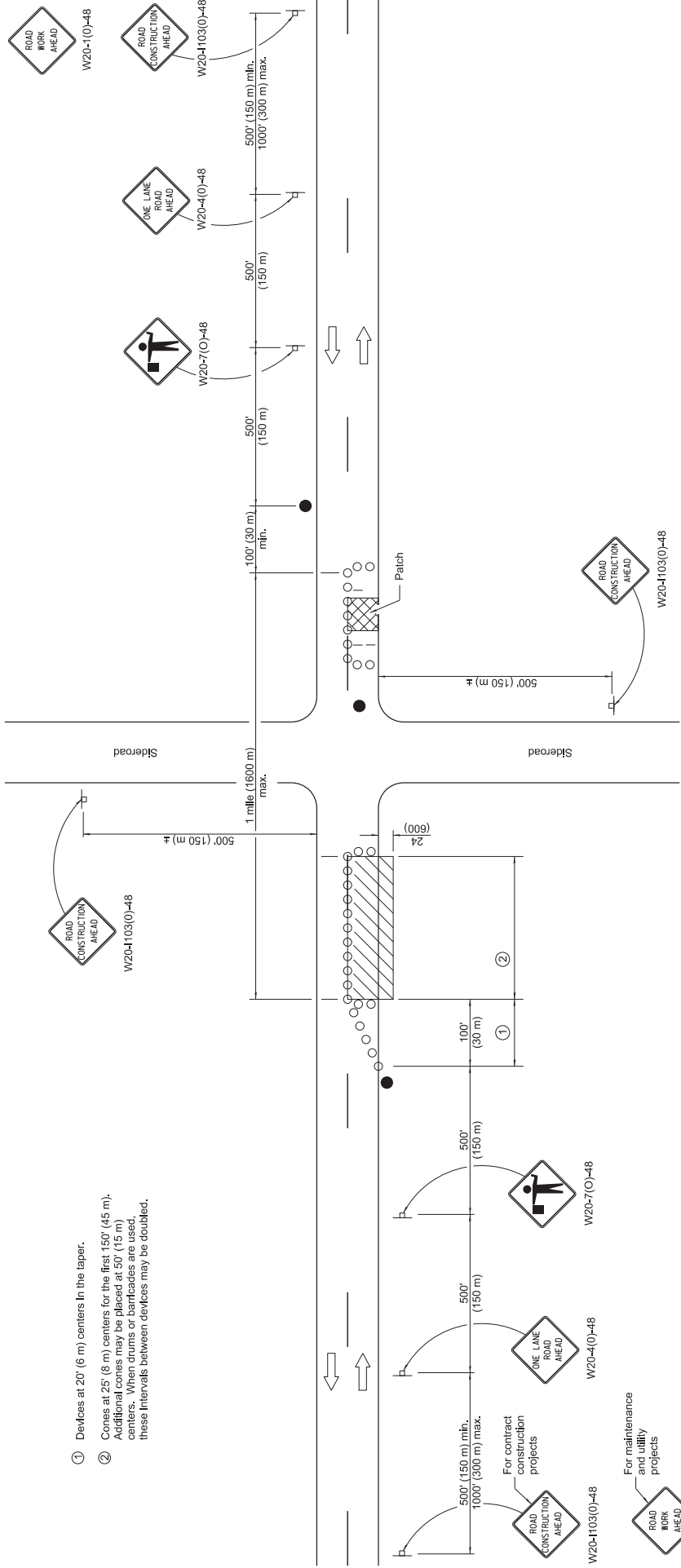

- ① Devices at 20' (6 m) centers in the taper.
- ② Cones at 25' (8 m) centers for the first 150' (45 m). Additional cones may be placed at 50' (15 m) centers. When drums or barricades are used, these intervals between devices may be doubled.

GENERAL NOTES

This Standard is used where at any time, any vehicles, equipment, workers or their activities will encroach in the area between the center line and a line 24' (800') outside the edge of pavement for daylight operation.

When the distance between successive work areas exceeds 2000' (600 m), additional warning signs, flaggers, and taper shall be placed as shown.

All dimensions are in inches (millimeters) unless otherwise shown.

SYMBOLS

- Work area
- Sign
- Barricade or drum
- Cone, drum or barricade
- Flagger with traffic control sign

TYPICAL APPLICATIONS

- Isolated patching
- Utility operations
- Storm sewer
- Culverts
- Cable placement

For maintenance and utility projects

DATE	REVISIONS
1-1-19	Revised device spacing in taper.
1-1-11	Revised flagger sign.

**LANE CLOSURE, 2L 2W,
DAY ONLY,
FOR SPEEDS ≥ 45 MPH**

STANDARD 701201-05

	APPROVED	January 1, 2019
		2019
	APPROVED	January 1, 2019
	2019	
ENGINEER OF DESIGN AND ENVIRONMENT		

ISSUED 1-1-97

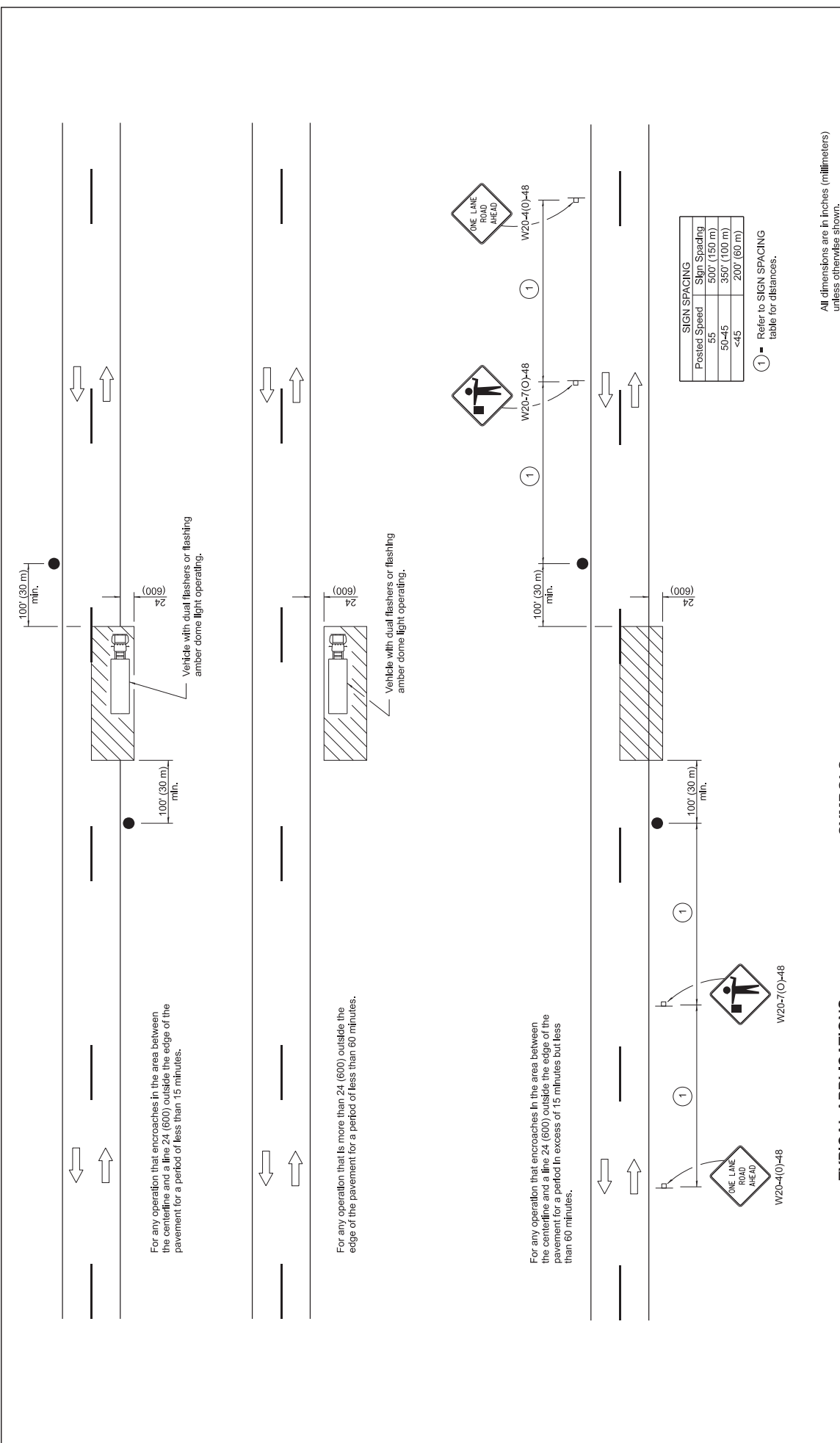

For any operation that encroaches in the area between the centerline and a line 24 (600) outside the edge of the pavement for a period of less than 15 minutes.

For any operation that is more than 24 (600) outside the edge of the pavement for a period of less than 60 minutes.

For any operation that encroaches in the area between the centerline and a line 24 (600) outside the edge of the pavement for a period in excess of 15 minutes but less than 60 minutes.

Posted Speed	Sign Spacing
55	500' (150 m)
50-45	350' (100 m)
<45	200' (60 m)

① Refer to SIGN SPACING table for distances.

All dimensions are in inches (millimeters) unless otherwise shown.

DATE	REVISIONS
1-1-11	Revised flagger sign.
1-1-09	Switched units to English (metric).

SYMBOLS

- Work area
- Sign on portable or permanent support
- Flagger with traffic control sign

TYPICAL APPLICATIONS

- Marking patches
- Field survey
- String line
- Utility operations
- Cleaning up debris on pavement

ILLINOIS Department of Transportation
 APPROVED: *[Signature]* January 1, 2011
 ENGINEER OF SAFETY ENGINEERING
 APPROVED: *[Signature]* January 1, 2011
 ENGINEER OF DESIGN AND ENVIRONMENT

ISSUED 1-1-07

LANE CLOSURE, 2L, 2W, SHORT TIME OPERATIONS

STANDARD 701301-04

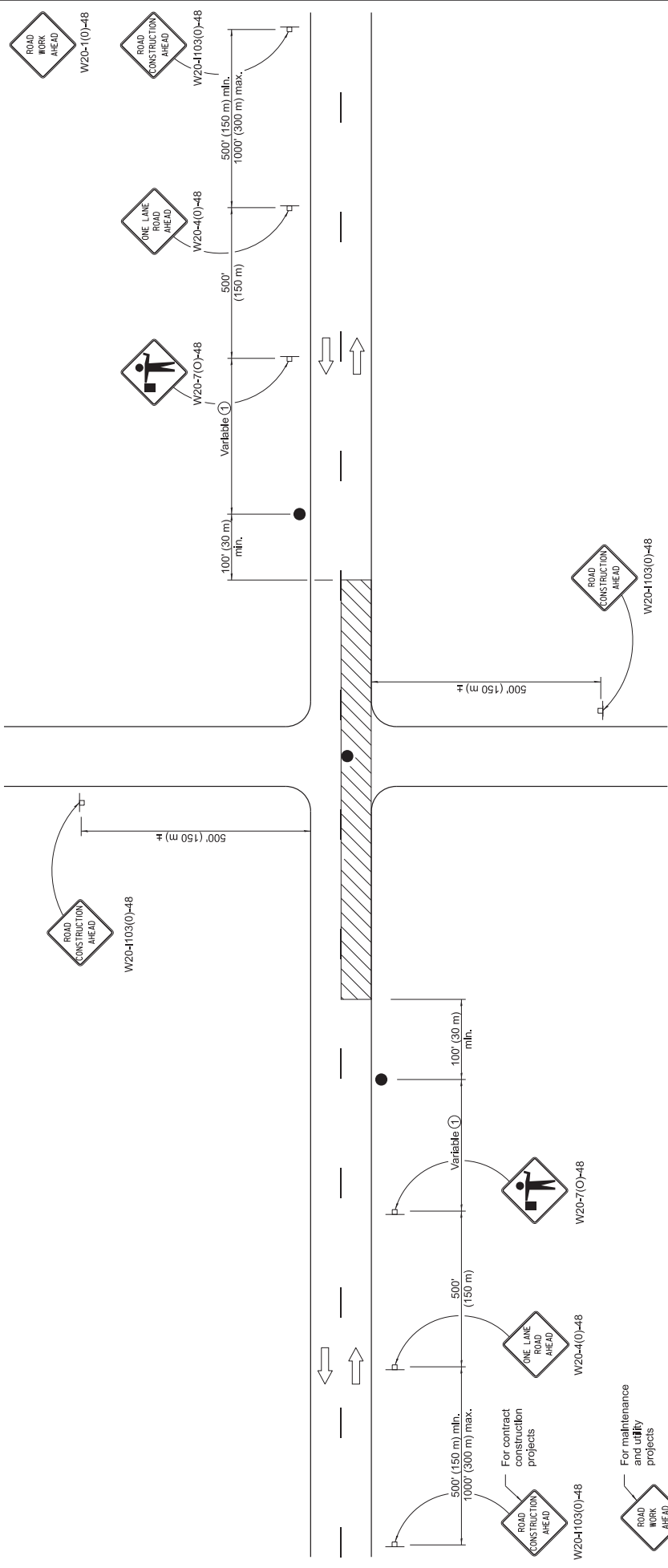

GENERAL NOTES

This Standard is used where at any time, any vehicle, equipment, workers or their activities require an impediment or a change in moving operation on the pavement where the average speed of movement is greater than 1/2 mph (1 km/h) and less than 4 mph (6 km/h).
 When the operation does not exceed 60 minutes, traffic control may be according to Standard 701301.
 All dimensions are in inches (millimeters) unless otherwise shown.

TYPICAL APPLICATIONS

- Bituminous resurfacing
- Milling operations
- Utility operations
- Shoulder operations

SYMBOLS

- Work area
- Sign on portable or permanent support
- Flagger with traffic control sign

- Minimum distance is 200' (60 m). Maximum distance to be determined by the Engineer but should not exceed 1/2 the length required for one normal working day's operation or 2 miles (3200 m), whichever is less.

DATE	REVISIONS
1-1-18	Revised lower speed limit for operation to 1/2 mph.
1-1-11	Revised flagger sign.

LANE CLOSURE, 2L, 2W, SLOW MOVING OPERATIONS DAY ONLY, FOR SPEEDS ≥ 45 MPH

STANDARD 701306-04

Illinois Department of Transportation
 APPROVED January 1, 2018
 ENGINEER OF SAFETY PROCS. AND ENGINEERING
 APPROVED January 1, 2018
 ENGINEER OF DESIGN AND ENVIRONMENT

ISSUED 1-1-97

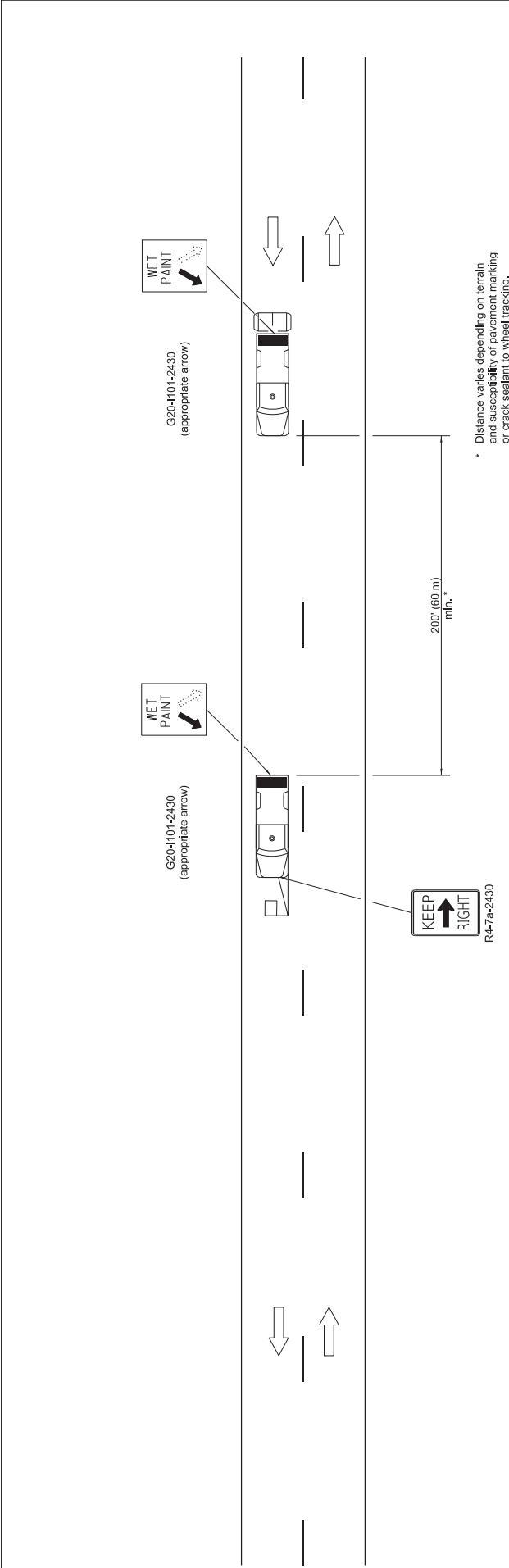

TYPICAL APPLICATIONS

- Landscaping work
- Utility work
- Pavement marking
- Seed spraying
- Rodentmeter measurements
- Debris cleanup
- Crack pouring

SYMBOLS

- Arrow board (Hazard Mode only)
- Truck with headlights, emergency flashers and flashing amber light (visible from all directions)
- 18 x 18 (450x450) min., orange flag (use when guide wheel is used)
- Truck mounted attenuator

GENERAL NOTES

This Standard is used where any vehicle equipment, when in their activities, will be a contractor's moving operation where the average speed is greater than 3 mph (5 km/h).

For shoulder operations not encroaching on the pavement, use DETAIL A, Standard 701426.

All dimensions are in inches (millimeters) unless otherwise shown.

LANE CLOSURE 2L, 2W MOVING OPERATIONS- DAY ONLY	
DATE	REVISIONS
1-1-09	Switched units to English (metric), Omitted Pass With Care sign.
1-1-00	Eliminated speed restrictions in Standard title.

STANDARD 701311-03

ISSUED 1-1-87

Illinois Department of Transportation

APPROVED January 1, 2009
 SCOTT R. COLE
 ENGINEER OF OPERATIONS

APPROVED January 1, 2009
 LEE C. HO
 ENGINEER OF DESIGN AND ENVIRONMENT

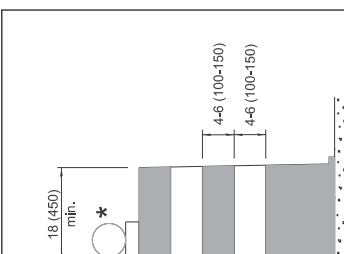

DAYTIME USE
Posted speed < 45 mph
Orange
Any posted speed

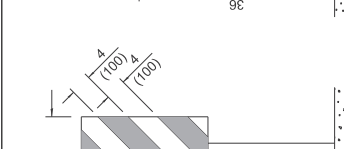

DAY OR NIGHTTIME USE
Any posted speed
Orange
Any posted speed

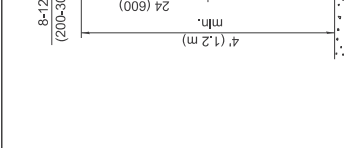

TUBULAR MARKER

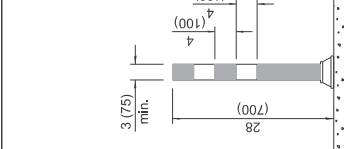

VERTICAL PANEL POST MOUNTED

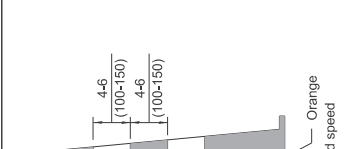

DRUM

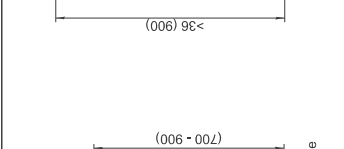

VERTICAL BARRIER

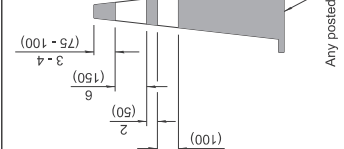

DIRECTION INDICATOR BARRIER

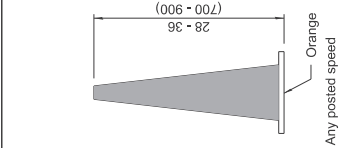

TYPE I BARRIER

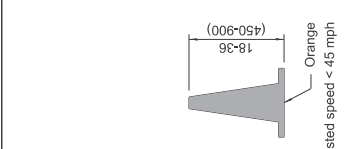

TYPE II BARRIER



TYPE III BARRIER

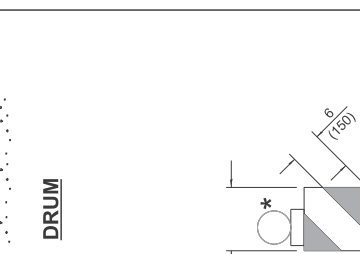

DETECTABLE PEDESTRIAN CHANNELIZING BARRIER



VERTICAL BARRIER

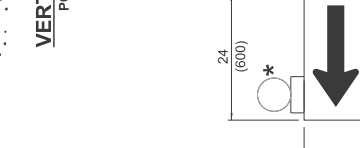

VERTICAL BARRIER

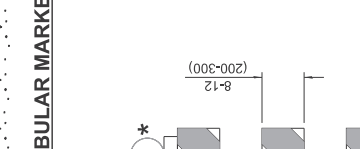

VERTICAL BARRIER

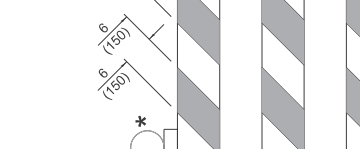

VERTICAL BARRIER



VERTICAL BARRIER

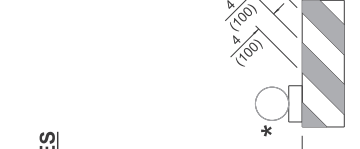

VERTICAL BARRIER

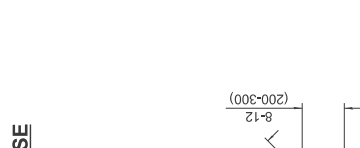

VERTICAL BARRIER

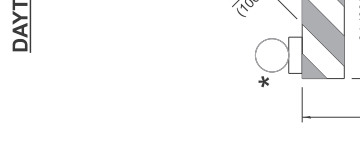

VERTICAL BARRIER



VERTICAL BARRIER

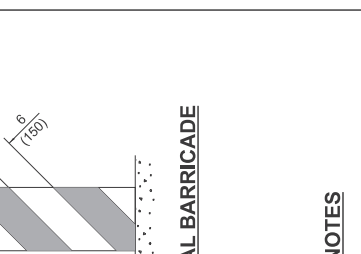

VERTICAL BARRIER



VERTICAL BARRIER

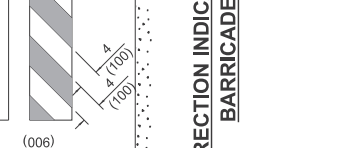

VERTICAL BARRIER

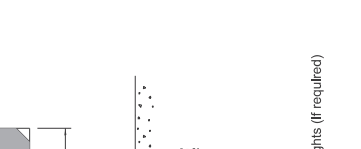

VERTICAL BARRIER

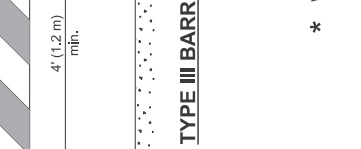

VERTICAL BARRIER

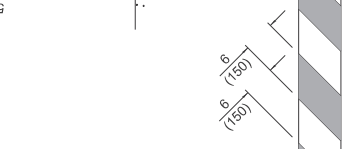

VERTICAL BARRIER



VERTICAL BARRIER



VERTICAL BARRIER

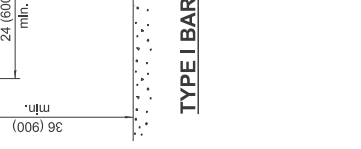

VERTICAL BARRIER



VERTICAL BARRIER

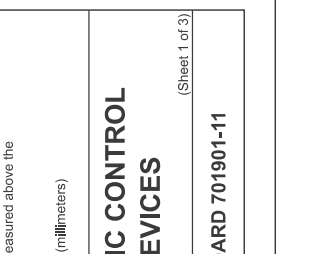

VERTICAL BARRIER

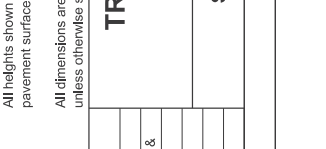

VERTICAL BARRIER

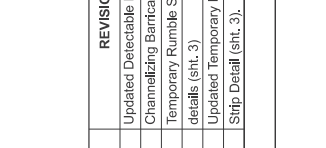

VERTICAL BARRIER



VERTICAL BARRIER



VERTICAL BARRIER



VERTICAL BARRIER

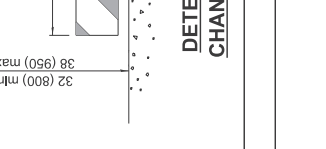

VERTICAL BARRIER

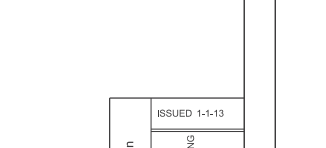

VERTICAL BARRIER

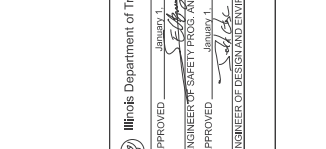

VERTICAL BARRIER



VERTICAL BARRIER

GENERAL NOTES
All heights shown shall be measured above the pavement surface.
All dimensions are in inches (millimeters) unless otherwise shown.

DATE	REVISIONS
1-1-26	Updated Detectable Pedestrian Channelizing Barrier (sht. 1) & Temporary Rumble Strips details (sht. 3)
1-1-25	Updated Temporary Rumble Strip Detail (sht. 3).

TRAFFIC CONTROL DEVICES
(Sheet 1 of 3)

STANDARD 701901-11

Illinois Department of Transportation
APPROVED January 1, 2026
ENGINEER OF SAFETY PROCS. AND ENGINEERING
APPROVED January 1, 2026
ENGINEER OF DESIGN AND ENVIRONMENT

ISSUED 1-1-13

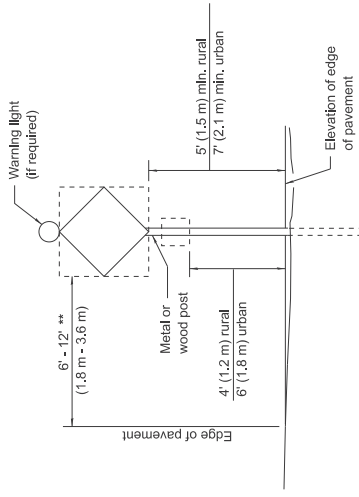

POST MOUNTED SIGNS

** When curb or paved shoulder are present this dimension shall be 24 (600) to the face of curb or 6' (1.8 m) to the outside edge of the paved shoulder.

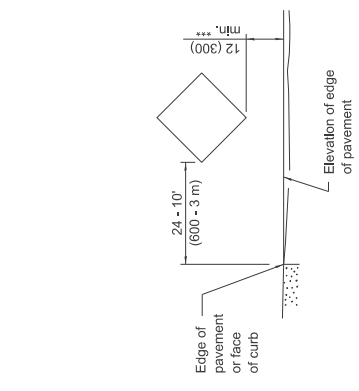

SIGNS ON TEMPORARY SUPPORTS

*** When work operations exceed four days, this dimension shall be 5' (1.5 m) min. If located behind other devices, the height shall be sufficient to be seen completely above the devices.

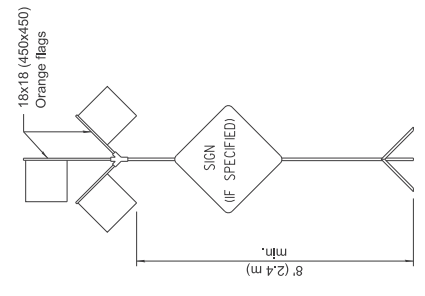

HIGH LEVEL WARNING DEVICE

ROAD CONSTRUCTION NEXT X MILES
G20-1104(0)-6036

END CONSTRUCTION
G20-1105(0)-6024

This signing is required for all projects 2 miles (3200 m) or more in length.
ROAD CONSTRUCTION NEXT X MILES sign shall be placed 500' (150 m) in advance of project limits.
END CONSTRUCTION sign shall be erected at the end of the job unless another job is within 2 miles (3200 m).
Dual sign displays shall be utilized on multi-lane highways.

WORK LIMIT SIGNING

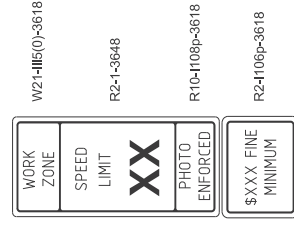

Sign assembly as shown on Standards or as allowed by District Operations.

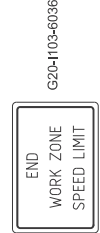

This sign shall be used when the above sign assembly is used.

HIGHWAY CONSTRUCTION SPEED ZONE SIGNS

**** R10-1108p shall only be used along roadways under the jurisdiction of the State.

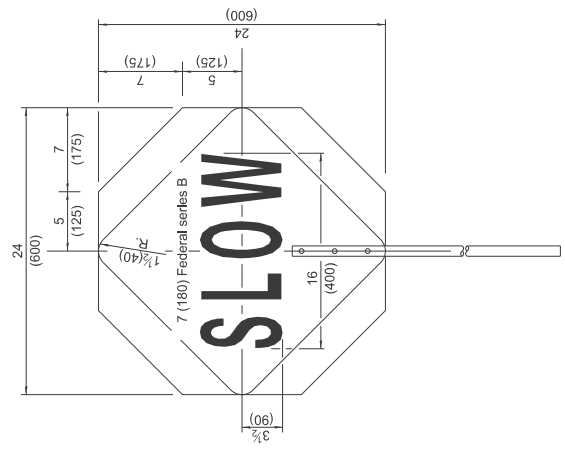
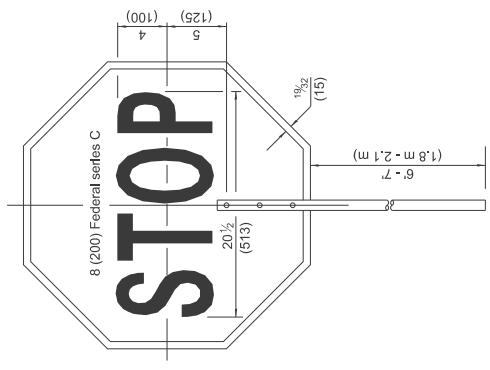

FLAGGER TRAFFIC CONTROL SIGN

FRONT SIDE

REVERSE SIDE

TRAFFIC CONTROL DEVICES
STANDARD 701901-11
(Sheet 2 of 3)

Illinois Department of Transportation
APPROVED January 1, 2026
ENGINEER OF SAFETY PROCS. AND ENGINEERING
APPROVED January 1, 2026
ENGINEER OF DESIGN AND ENVIRONMENT

ISSUED 1-1-13

WIDTH RESTRICTION SIGN

XX-XX* width and X miles are variable.

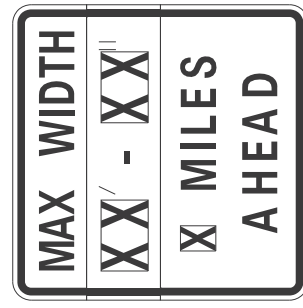

W12-1103-4646

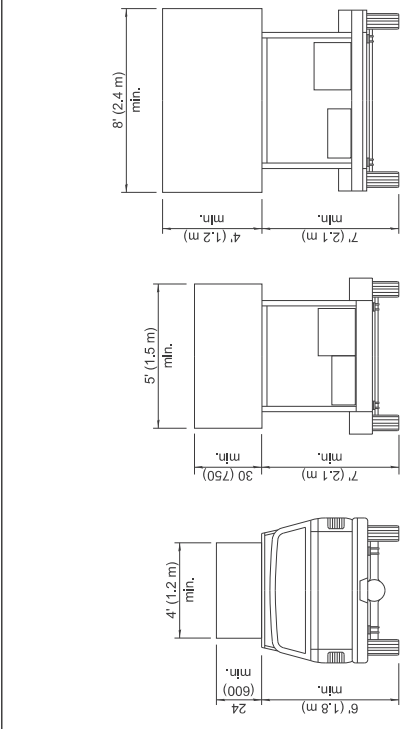

ARROW BOARDS

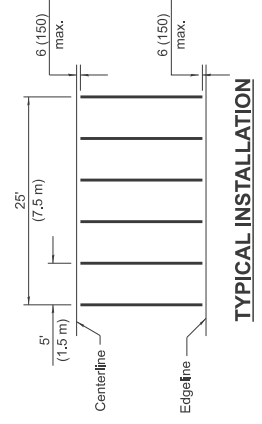
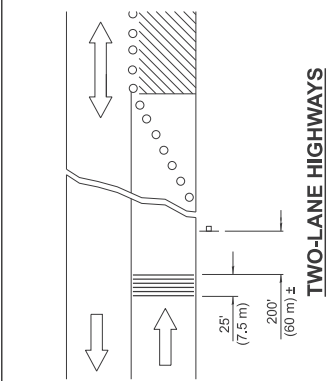
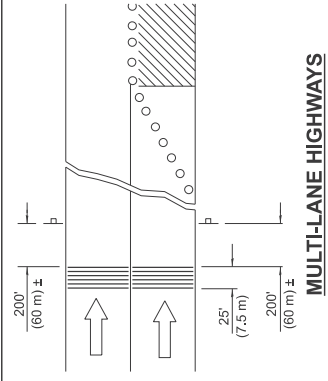
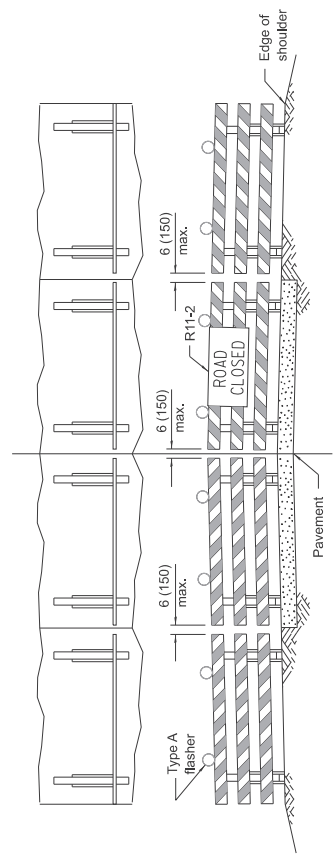

TEMPORARY RUMBLE STRIPS

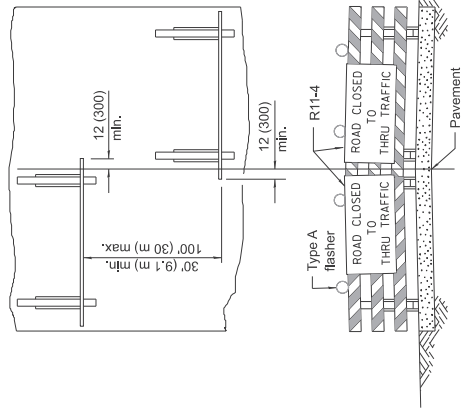

ROAD CLOSED TO THRU TRAFFIC
ReflectORIZED striping shall appear on both sides of the barricades.

**TYPICAL APPLICATIONS OF
TYPE III BARRICADES CLOSING A ROAD**

If a Type III barricade with an attached sign panel which meets NCHRP 350 or MASH is not available, the sign may be mounted on an NCHRP 350 or MASH temporary sign support directly in front of the barricade.

Illinois Department of Transportation
ISSUED 1-1-13

APPROVED January 1, 2026
ENGINEER OF SAFETY PROCS. AND ENGINEERING
APPROVED January 1, 2026
ENGINEER OF DESIGN AND ENVIRONMENT

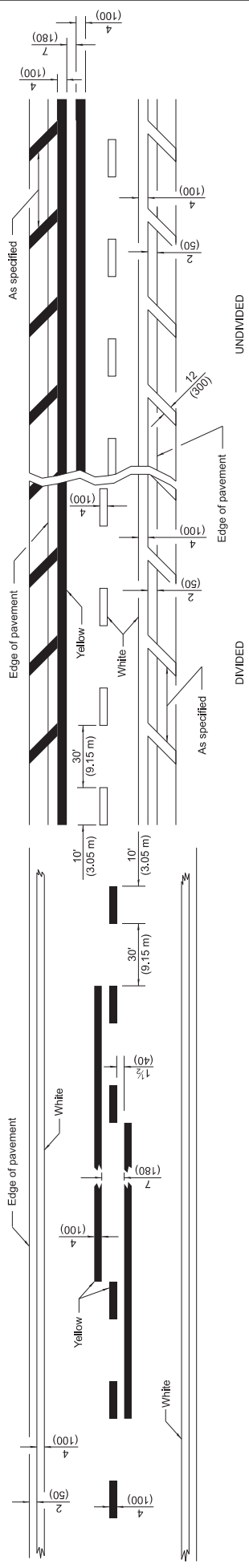

2 LANE

DIVIDED

UNDIVIDED

LANE AND EDGE LINES

Approximately 15' (4.5 m) from nearest rail or 8' (2.4 m) back from gate, if present. Stop line placed perpendicular to center line.

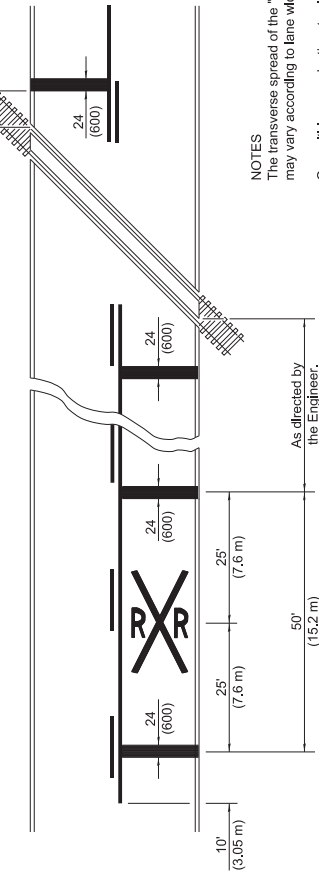

NOTES
 The transverse spread of the "X" may vary according to lane width.
 On multi-lane roads, the stop lines shall extend across all approach lanes and separate RXR symbols shall be placed adjacent to each other in each lane.

When the pavement marking symbol is used, a portion of the symbol should be located directly adjacent to the Advance Warning Sign (W10-1) as placed by Table 2C-4, Condition B of the MUTCD.

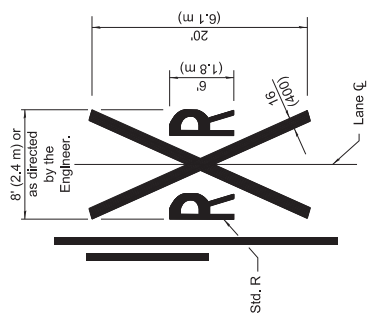

All dimensions are in inches (millimeters) unless otherwise shown.

PAVEMENT MARKINGS AT RAILROAD-HIGHWAY GRADE CROSSING

TYPICAL PAVEMENT MARKINGS

DATE	REVISIONS
1-1-15	Added symbols, Revised bike symbol, Revised note for stop line at RR crossing.
1-1-14	Added bike symbol, Renamed 'LANE DROP ARROW' detail to 'LANE-REDUCTION ARROW'.

APPROVED ENGINEER OF OPERATIONS APPROVED ENGINEER OF DESIGN AND ENVIRONMENT	ISSUED 1-1-97 January 1, 2015 January 1, 2015
--	---

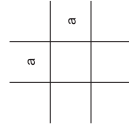
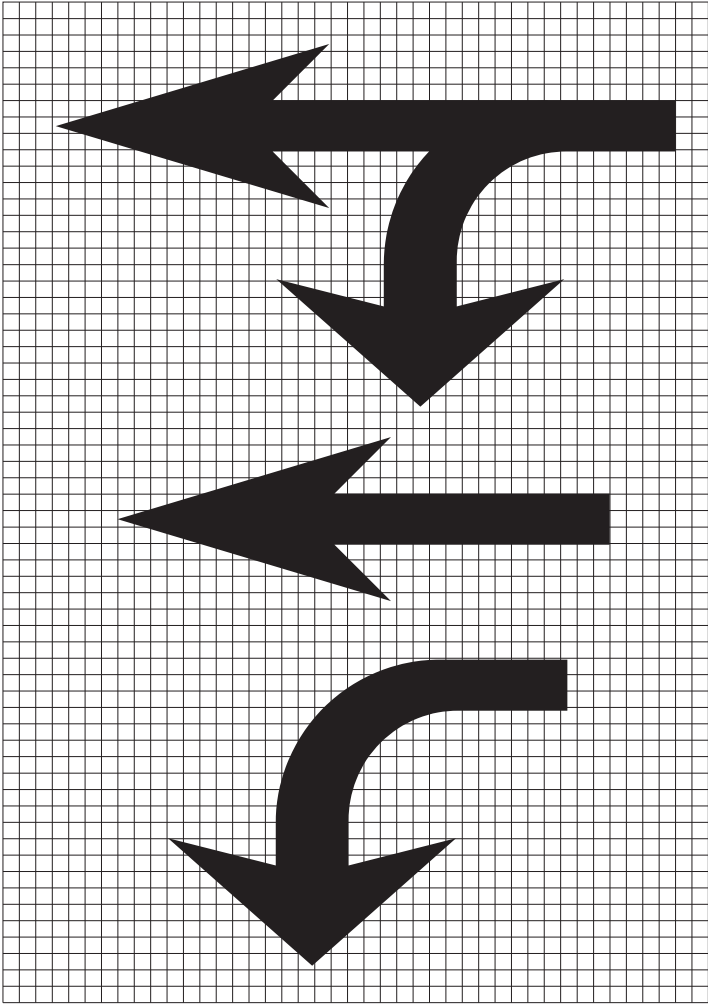
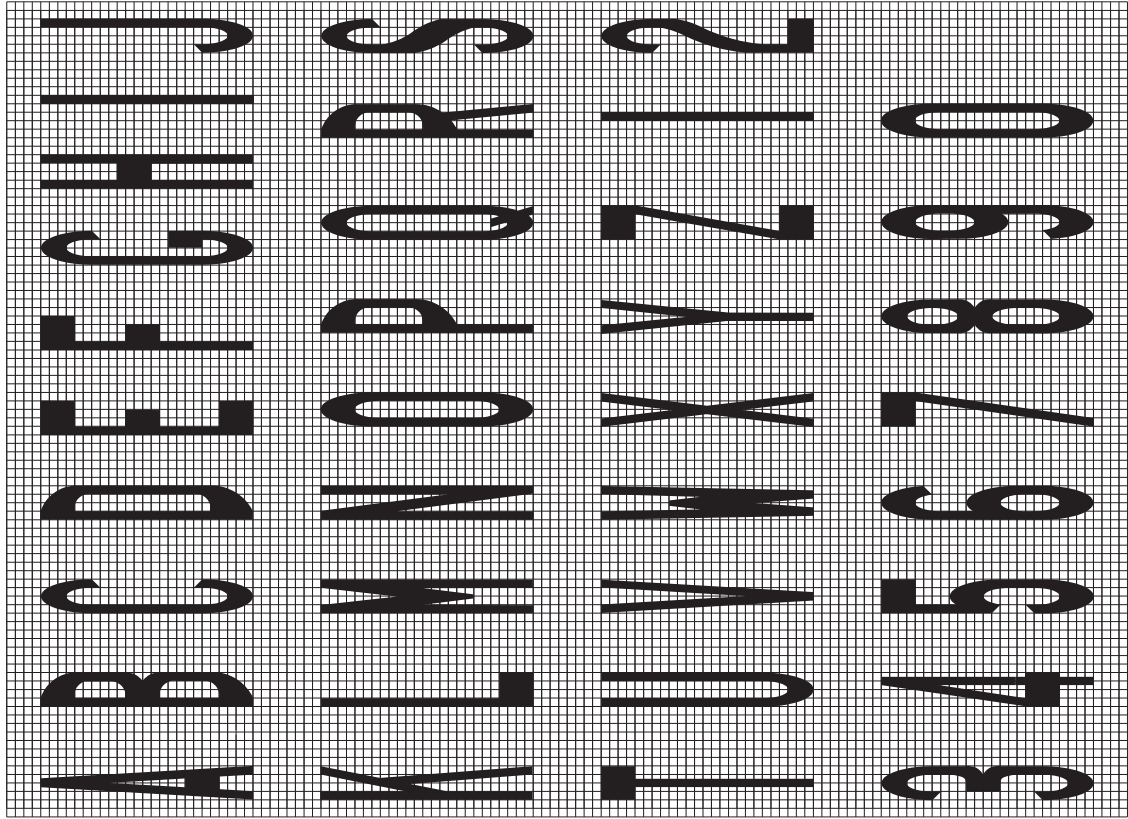

Legend Height	Arrow Size	a
6' (1.8 m)	Small	2.9 (74)
8' (2.4 m)	Large	3.8 (96)

The space between adjacent letters or numerals should be approximately 3/75) for 6' (1.8 m) legend and 4/100) for 8' (2.4 m) legend.

LETTER AND ARROW GRID SCALE

Illinois Department of Transportation
 APPROVED *John Allen* January 1, 2015
 ENGINEER OF OPERATIONS
 APPROVED *[Signature]* January 1, 2015
 ENGINEER OF DESIGN AND ENVIRONMENT

ISSUED 1-1-97

TYPICAL PAVEMENT MARKINGS

(Sheet 2 of 3)

STANDARD 780001-05



Small size: urban
Large size: rural

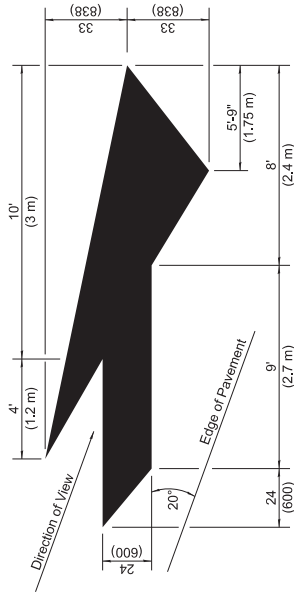

LANE-REDUCTION ARROW

Right lane-reduction arrow shown.
Use mirror image for left lane.



WORD AND ARROW LAYOUT

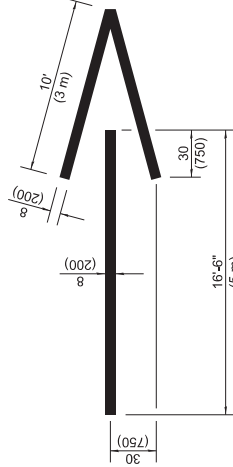

WRONG WAY ARROW

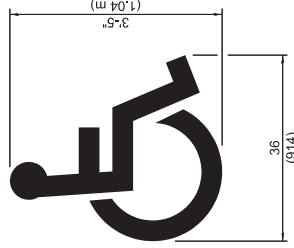

INTERNATIONAL SYMBOL OF ACCESSIBILITY

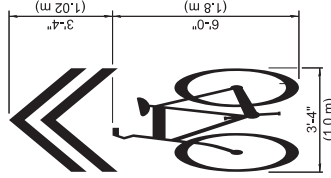

SHARED LANE SYMBOL

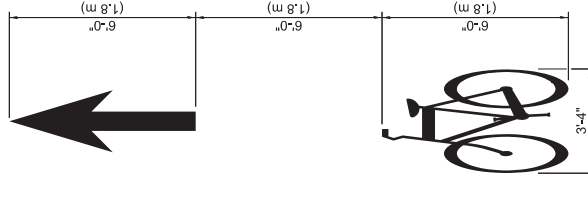

BIKE SYMBOL
(Arrow is optional)

Illinois Department of Transportation

APPROVED January 1, 2015

ENGINEER OF OPERATIONS

APPROVED January 1, 2015

ENGINEER OF DESIGN AND ENVIRONMENT

ISSUED 11-1-97

TYPICAL PAVEMENT MARKINGS

(Sheet 3 of 3)

STANDARD 780001-05

REQUIRED CONTRACT PROVISIONS FEDERAL-AID CONSTRUCTION CONTRACTS

- I. General
- II. Nondiscrimination
- III. Non-segregated Facilities
- IV. Davis-Bacon and Related Act Provisions
- V. Contract Work Hours and Safety Standards Act Provisions
- VI. Subletting or Assigning the Contract
- VII. Safety: Accident Prevention
- VIII. False Statements Concerning Highway Projects
- IX. Implementation of Clean Air Act and Federal Water Pollution Control Act
- X. Certification Regarding Debarment, Suspension, Ineligibility and Voluntary Exclusion
- XI. Certification Regarding Use of Contract Funds for Lobbying
- XII. Use of United States-Flag Vessels:

ATTACHMENTS

A. Employment and Materials Preference for Appalachian Development Highway System or Appalachian Local Access Road Contracts (included in Appalachian contracts only)

I. GENERAL

1. Form FHWA-1273 must be physically incorporated in each construction contract funded under title 23, United States Code, as required in 23 CFR 633.102(b) (excluding emergency contracts solely intended for debris removal). The contractor (or subcontractor) must insert this form in each subcontract and further require its inclusion in all lower tier subcontracts (excluding purchase orders, rental agreements and other agreements for supplies or services). 23 CFR 633.102(e).

The applicable requirements of Form FHWA-1273 are incorporated by reference for work done under any purchase order, rental agreement or agreement for other services. The prime contractor shall be responsible for compliance by any subcontractor, lower-tier subcontractor or service provider. 23 CFR 633.102(e).

Form FHWA-1273 must be included in all Federal-aid design-build contracts, in all subcontracts and in lower tier subcontracts (excluding subcontracts for design services, purchase orders, rental agreements and other agreements for supplies or services) in accordance with 23 CFR 633.102. The design-builder shall be responsible for compliance by any subcontractor, lower-tier subcontractor or service provider.

Contracting agencies may reference Form FHWA-1273 in solicitation-for-bids or request-for-proposals documents, however, the Form FHWA-1273 must be physically incorporated (not referenced) in all contracts, subcontracts and lower-tier subcontracts (excluding purchase orders, rental agreements and other agreements for supplies or services related to a construction contract). 23 CFR 633.102(b).

2. Subject to the applicability criteria noted in the following sections, these contract provisions shall apply to all work

performed on the contract by the contractor's own organization and with the assistance of workers under the contractor's immediate superintendence and to all work performed on the contract by piecework, station work, or by subcontract. 23 CFR 633.102(d).

3. A breach of any of the stipulations contained in these Required Contract Provisions may be sufficient grounds for withholding of progress payments, withholding of final payment, termination of the contract, suspension / debarment or any other action determined to be appropriate by the contracting agency and FHWA.

4. Selection of Labor: During the performance of this contract, the contractor shall not use convict labor for any purpose within the limits of a construction project on a Federal-aid highway unless it is labor performed by convicts who are on parole, supervised release, or probation. 23 U.S.C. 114(b). The term Federal-aid highway does not include roadways functionally classified as local roads or rural minor collectors. 23 U.S.C. 101(a).

II. NONDISCRIMINATION (23 CFR 230.107(a); 23 CFR Part 230, Subpart A, Appendix A; EO 11246)

The provisions of this section related to 23 CFR Part 230, Subpart A, Appendix A are applicable to all Federal-aid construction contracts and to all related construction subcontracts of \$10,000 or more. The provisions of 23 CFR Part 230 are not applicable to material supply, engineering, or architectural service contracts.

In addition, the contractor and all subcontractors must comply with the following policies: Executive Order 11246, 41 CFR Part 60, 29 CFR Parts 1625-1627, 23 U.S.C. 140, Section 504 of the Rehabilitation Act of 1973, as amended (29 U.S.C. 794), Title VI of the Civil Rights Act of 1964, as amended (42 U.S.C. 2000d et seq.), and related regulations including 49 CFR Parts 21, 26, and 27; and 23 CFR Parts 200, 230, and 633.

The contractor and all subcontractors must comply with: the requirements of the Equal Opportunity Clause in 41 CFR 60-1.4(b) and, for all construction contracts exceeding \$10,000, the Standard Federal Equal Employment Opportunity Construction Contract Specifications in 41 CFR 60-4.3.

Note: The U.S. Department of Labor has exclusive authority to determine compliance with Executive Order 11246 and the policies of the Secretary of Labor including 41 CFR Part 60, and 29 CFR Parts 1625-1627. The contracting agency and the FHWA have the authority and the responsibility to ensure compliance with 23 U.S.C. 140, Section 504 of the Rehabilitation Act of 1973, as amended (29 U.S.C. 794), and Title VI of the Civil Rights Act of 1964, as amended (42 U.S.C. 2000d et seq.), and related regulations including 49 CFR Parts 21, 26, and 27; and 23 CFR Parts 200, 230, and 633.

The following provision is adopted from 23 CFR Part 230, Subpart A, Appendix A, with appropriate revisions to conform to the U.S. Department of Labor (US DOL) and FHWA requirements.

1. Equal Employment Opportunity: Equal Employment Opportunity (EEO) requirements not to discriminate and to take affirmative action to assure equal opportunity as set forth under laws, executive orders, rules, regulations (see 28 CFR Part 35, 29 CFR Part 1630, 29 CFR Parts 1625-1627, 41 CFR Part 60 and 49 CFR Part 27) and orders of the Secretary of Labor as modified by the provisions prescribed herein, and imposed pursuant to 23 U.S.C. 140, shall constitute the EEO and specific affirmative action standards for the contractor's project activities under this contract. The provisions of the Americans with Disabilities Act of 1990 (42 U.S.C. 12101 et seq.) set forth under 28 CFR Part 35 and 29 CFR Part 1630 are incorporated by reference in this contract. In the execution of this contract, the contractor agrees to comply with the following minimum specific requirement activities of EEO:

a. The contractor will work with the contracting agency and the Federal Government to ensure that it has made every good faith effort to provide equal opportunity with respect to all of its terms and conditions of employment and in their review of activities under the contract. 23 CFR 230.409 (g)(4) & (5).

b. The contractor will accept as its operating policy the following statement:

"It is the policy of this Company to assure that applicants are employed, and that employees are treated during employment, without regard to their race, religion, sex, sexual orientation, gender identity, color, national origin, age or disability. Such action shall include: employment, upgrading, demotion, or transfer; recruitment or recruitment advertising; layoff or termination; rates of pay or other forms of compensation; and selection for training, including apprenticeship, pre-apprenticeship, and/or on-the-job training."

2. EEO Officer: The contractor will designate and make known to the contracting officers an EEO Officer who will have the responsibility for and must be capable of effectively administering and promoting an active EEO program and who must be assigned adequate authority and responsibility to do so.

3. Dissemination of Policy: All members of the contractor's staff who are authorized to hire, supervise, promote, and discharge employees, or who recommend such action or are substantially involved in such action, will be made fully cognizant of and will implement the contractor's EEO policy and contractual responsibilities to provide EEO in each grade and classification of employment. To ensure that the above agreement will be met, the following actions will be taken as a minimum:

a. Periodic meetings of supervisory and personnel office employees will be conducted before the start of work and then not less often than once every six months, at which time the contractor's EEO policy and its implementation will be reviewed and explained. The meetings will be conducted by the EEO Officer or other knowledgeable company official.

b. All new supervisory or personnel office employees will be given a thorough indoctrination by the EEO Officer, covering all major aspects of the contractor's EEO obligations within thirty days following their reporting for duty with the contractor.

c. All personnel who are engaged in direct recruitment for the project will be instructed by the EEO Officer in the contractor's procedures for locating and hiring minorities and women.

d. Notices and posters setting forth the contractor's EEO policy will be placed in areas readily accessible to employees, applicants for employment and potential employees.

e. The contractor's EEO policy and the procedures to implement such policy will be brought to the attention of employees by means of meetings, employee handbooks, or other appropriate means.

4. Recruitment: When advertising for employees, the contractor will include in all advertisements for employees the notation: "An Equal Opportunity Employer." All such advertisements will be placed in publications having a large circulation among minorities and women in the area from which the project work force would normally be derived.

a. The contractor will, unless precluded by a valid bargaining agreement, conduct systematic and direct recruitment through public and private employee referral sources likely to yield qualified minorities and women. To meet this requirement, the contractor will identify sources of potential minority group employees and establish with such identified sources procedures whereby minority and women applicants may be referred to the contractor for employment consideration.

b. In the event the contractor has a valid bargaining agreement providing for exclusive hiring hall referrals, the contractor is expected to observe the provisions of that agreement to the extent that the system meets the contractor's compliance with EEO contract provisions. Where implementation of such an agreement has the effect of discriminating against minorities or women, or obligates the contractor to do the same, such implementation violates Federal nondiscrimination provisions.

c. The contractor will encourage its present employees to refer minorities and women as applicants for employment. Information and procedures with regard to referring such applicants will be discussed with employees.

5. Personnel Actions: Wages, working conditions, and employee benefits shall be established and administered, and personnel actions of every type, including hiring, upgrading, promotion, transfer, demotion, layoff, and termination, shall be taken without regard to race, color, religion, sex, sexual orientation, gender identity, national origin, age or disability. The following procedures shall be followed:

a. The contractor will conduct periodic inspections of project sites to ensure that working conditions and employee facilities do not indicate discriminatory treatment of project site personnel.

b. The contractor will periodically evaluate the spread of wages paid within each classification to determine any evidence of discriminatory wage practices.

c. The contractor will periodically review selected personnel actions in depth to determine whether there is evidence of discrimination. Where evidence is found, the contractor will promptly take corrective action. If the review indicates that the discrimination may extend beyond the actions reviewed, such corrective action shall include all affected persons.

d. The contractor will promptly investigate all complaints of alleged discrimination made to the contractor in connection with its obligations under this contract, will attempt to resolve such complaints, and will take appropriate corrective action

within a reasonable time. If the investigation indicates that the discrimination may affect persons other than the complainant, such corrective action shall include such other persons. Upon completion of each investigation, the contractor will inform every complainant of all of their avenues of appeal.

6. Training and Promotion:

a. The contractor will assist in locating, qualifying, and increasing the skills of minorities and women who are applicants for employment or current employees. Such efforts should be aimed at developing full journey level status employees in the type of trade or job classification involved.

b. Consistent with the contractor's work force requirements and as permissible under Federal and State regulations, the contractor shall make full use of training programs (i.e., apprenticeship and on-the-job training programs for the geographical area of contract performance). In the event a special provision for training is provided under this contract, this subparagraph will be superseded as indicated in the special provision. The contracting agency may reserve training positions for persons who receive welfare assistance in accordance with 23 U.S.C. 140(a).

c. The contractor will advise employees and applicants for employment of available training programs and entrance requirements for each.

d. The contractor will periodically review the training and promotion potential of employees who are minorities and women and will encourage eligible employees to apply for such training and promotion.

7. Unions: If the contractor relies in whole or in part upon unions as a source of employees, the contractor will use good faith efforts to obtain the cooperation of such unions to increase opportunities for minorities and women. 23 CFR 230.409. Actions by the contractor, either directly or through a contractor's association acting as agent, will include the procedures set forth below:

a. The contractor will use good faith efforts to develop, in cooperation with the unions, joint training programs aimed toward qualifying more minorities and women for membership in the unions and increasing the skills of minorities and women so that they may qualify for higher paying employment.

b. The contractor will use good faith efforts to incorporate an EEO clause into each union agreement to the end that such union will be contractually bound to refer applicants without regard to their race, color, religion, sex, sexual orientation, gender identity, national origin, age, or disability.

c. The contractor is to obtain information as to the referral practices and policies of the labor union except that to the extent such information is within the exclusive possession of the labor union and such labor union refuses to furnish such information to the contractor, the contractor shall so certify to the contracting agency and shall set forth what efforts have been made to obtain such information.

d. In the event the union is unable to provide the contractor with a reasonable flow of referrals within the time limit set forth in the collective bargaining agreement, the contractor will, through independent recruitment efforts, fill the employment vacancies without regard to race, color, religion, sex, sexual orientation, gender identity, national origin, age, or disability; making full efforts to obtain qualified and/or qualifiable minorities and women. The failure of a union to provide

sufficient referrals (even though it is obligated to provide exclusive referrals under the terms of a collective bargaining agreement) does not relieve the contractor from the requirements of this paragraph. In the event the union referral practice prevents the contractor from meeting the obligations pursuant to Executive Order 11246, as amended, and these special provisions, such contractor shall immediately notify the contracting agency.

8. Reasonable Accommodation for Applicants /

Employees with Disabilities: The contractor must be familiar with the requirements for and comply with the Americans with Disabilities Act and all rules and regulations established thereunder. Employers must provide reasonable accommodation in all employment activities unless to do so would cause an undue hardship.

9. Selection of Subcontractors, Procurement of Materials and Leasing of Equipment: The contractor shall not discriminate on the grounds of race, color, religion, sex, sexual orientation, gender identity, national origin, age, or disability in the selection and retention of subcontractors, including procurement of materials and leases of equipment. The contractor shall take all necessary and reasonable steps to ensure nondiscrimination in the administration of this contract.

a. The contractor shall notify all potential subcontractors, suppliers, and lessors of their EEO obligations under this contract.

b. The contractor will use good faith efforts to ensure subcontractor compliance with their EEO obligations.

10. Assurances Required:

a. The requirements of 49 CFR Part 26 and the State DOT's FHWA-approved Disadvantaged Business Enterprise (DBE) program are incorporated by reference.

b. The contractor, subrecipient or subcontractor shall not discriminate on the basis of race, color, national origin, or sex in the performance of this contract. The contractor shall carry out applicable requirements of 49 CFR part 26 in the award and administration of DOT-assisted contracts. Failure by the contractor to carry out these requirements is a material breach of this contract, which may result in the termination of this contract or such other remedy as the recipient deems appropriate, which may include, but is not limited to:

- (1) Withholding monthly progress payments;
- (2) Assessing sanctions;
- (3) Liquidated damages; and/or
- (4) Disqualifying the contractor from future bidding as non-responsible.

c. The Title VI and nondiscrimination provisions of U.S. DOT Order 1050.2A at Appendixes A and E are incorporated by reference. 49 CFR Part 21.

11. Records and Reports: The contractor shall keep such records as necessary to document compliance with the EEO requirements. Such records shall be retained for a period of three years following the date of the final payment to the contractor for all contract work and shall be available at reasonable times and places for inspection by authorized representatives of the contracting agency and the FHWA.

a. The records kept by the contractor shall document the following:

(1) The number and work hours of minority and non-minority group members and women employed in each work classification on the project;

(2) The progress and efforts being made in cooperation with unions, when applicable, to increase employment opportunities for minorities and women; and

(3) The progress and efforts being made in locating, hiring, training, qualifying, and upgrading minorities and women.

b. The contractors and subcontractors will submit an annual report to the contracting agency each July for the duration of the project indicating the number of minority, women, and non-minority group employees currently engaged in each work classification required by the contract work. This information is to be reported on [Form FHWA-1391](#). The staffing data should represent the project work force on board in all or any part of the last payroll period preceding the end of July. If on-the-job training is being required by special provision, the contractor will be required to collect and report training data. The employment data should reflect the work force on board during all or any part of the last payroll period preceding the end of July.

III. NONSEGREGATED FACILITIES

This provision is applicable to all Federal-aid construction contracts and to all related construction subcontracts of more than \$10,000. 41 CFR 60-1.5.

As prescribed by 41 CFR 60-1.8, the contractor must ensure that facilities provided for employees are provided in such a manner that segregation on the basis of race, color, religion, sex, sexual orientation, gender identity, or national origin cannot result. The contractor may neither require such segregated use by written or oral policies nor tolerate such use by employee custom. The contractor's obligation extends further to ensure that its employees are not assigned to perform their services at any location under the contractor's control where the facilities are segregated. The term "facilities" includes waiting rooms, work areas, restaurants and other eating areas, time clocks, restrooms, washrooms, locker rooms and other storage or dressing areas, parking lots, drinking fountains, recreation or entertainment areas, transportation, and housing provided for employees. The contractor shall provide separate or single-user restrooms and necessary dressing or sleeping areas to assure privacy between sexes.

IV. DAVIS-BACON AND RELATED ACT PROVISIONS

This section is applicable to all Federal-aid construction projects exceeding \$2,000 and to all related subcontracts and lower-tier subcontracts (regardless of subcontract size), in accordance with 29 CFR 5.5. The requirements apply to all projects located within the right-of-way of a roadway that is functionally classified as Federal-aid highway. 23 U.S.C. 113. This excludes roadways functionally classified as local roads or rural minor collectors, which are exempt. 23 U.S.C. 101. Where applicable law requires that projects be treated as a project on a Federal-aid highway, the provisions of this subpart will apply regardless of the location of the project. Examples include: Surface Transportation Block Grant Program projects funded under 23 U.S.C. 133 [excluding recreational trails projects], the Nationally Significant Freight and Highway

Projects funded under 23 U.S.C. 117, and National Highway Freight Program projects funded under 23 U.S.C. 167.

The following provisions are from the U.S. Department of Labor regulations in 29 CFR 5.5 "Contract provisions and related matters" with minor revisions to conform to the FHWA- 1273 format and FHWA program requirements.

1. Minimum wages (29 CFR 5.5)

a. *Wage rates and fringe benefits.* All laborers and mechanics employed or working upon the site of the work (or otherwise working in construction or development of the project under a development statute), will be paid unconditionally and not less often than once a week, and without subsequent deduction or rebate on any account (except such payroll deductions as are permitted by regulations issued by the Secretary of Labor under the Copeland Act ([29 CFR part 3](#))), the full amount of basic hourly wages and bona fide fringe benefits (or cash equivalents thereof) due at time of payment computed at rates not less than those contained in the wage determination of the Secretary of Labor which is attached hereto and made a part hereof, regardless of any contractual relationship which may be alleged to exist between the contractor and such laborers and mechanics. As provided in paragraphs (d) and (e) of 29 CFR 5.5, the appropriate wage determinations are effective by operation of law even if they have not been attached to the contract. Contributions made or costs reasonably anticipated for bona fide fringe benefits under the Davis-Bacon Act ([40 U.S.C. 3141\(2\)\(B\)](#)) on behalf of laborers or mechanics are considered wages paid to such laborers or mechanics, subject to the provisions of paragraph 1.e. of this section; also, regular contributions made or costs incurred for more than a weekly period (but not less often than quarterly) under plans, funds, or programs which cover the particular weekly period, are deemed to be constructively made or incurred during such weekly period. Such laborers and mechanics must be paid the appropriate wage rate and fringe benefits on the wage determination for the classification(s) of work actually performed, without regard to skill, except as provided in paragraph 4. of this section. Laborers or mechanics performing work in more than one classification may be compensated at the rate specified for each classification for the time actually worked therein: *Provided*, That the employer's payroll records accurately set forth the time spent in each classification in which work is performed. The wage determination (including any additional classifications and wage rates conformed under paragraph 1.c. of this section) and the Davis-Bacon poster (WH-1321) must be posted at all times by the contractor and its subcontractors at the site of the work in a prominent and accessible place where it can be easily seen by the workers.

b. *Frequently recurring classifications.* (1) In addition to wage and fringe benefit rates that have been determined to be prevailing under the procedures set forth in [29 CFR part 1](#), a wage determination may contain, pursuant to § 1.3(f), wage and fringe benefit rates for classifications of laborers and mechanics for which conformance requests are regularly submitted pursuant to paragraph 1.c. of this section, provided that:

(i) The work performed by the classification is not performed by a classification in the wage determination for which a prevailing wage rate has been determined;

(ii) The classification is used in the area by the construction industry; and

(iii) The wage rate for the classification bears a reasonable relationship to the prevailing wage rates contained in the wage determination.

(2) The Administrator will establish wage rates for such classifications in accordance with paragraph 1.c.(1)(iii) of this section. Work performed in such a classification must be paid at no less than the wage and fringe benefit rate listed on the wage determination for such classification.

c. *Conformance.* (1) The contracting officer must require that any class of laborers or mechanics, including helpers, which is not listed in the wage determination and which is to be employed under the contract be classified in conformance with the wage determination. Conformance of an additional classification and wage rate and fringe benefits is appropriate only when the following criteria have been met:

(i) The work to be performed by the classification requested is not performed by a classification in the wage determination; and

(ii) The classification is used in the area by the construction industry; and

(iii) The proposed wage rate, including any bona fide fringe benefits, bears a reasonable relationship to the wage rates contained in the wage determination.

(2) The conformance process may not be used to split, subdivide, or otherwise avoid application of classifications listed in the wage determination.

(3) If the contractor and the laborers and mechanics to be employed in the classification (if known), or their representatives, and the contracting officer agree on the classification and wage rate (including the amount designated for fringe benefits where appropriate), a report of the action taken will be sent by the contracting officer by email to DBAconformance@dol.gov. The Administrator, or an authorized representative, will approve, modify, or disapprove every additional classification action within 30 days of receipt and so advise the contracting officer or will notify the contracting officer within the 30-day period that additional time is necessary.

(4) In the event the contractor, the laborers or mechanics to be employed in the classification or their representatives, and the contracting officer do not agree on the proposed classification and wage rate (including the amount designated for fringe benefits, where appropriate), the contracting officer will, by email to DBAconformance@dol.gov, refer the questions, including the views of all interested parties and the recommendation of the contracting officer, to the Administrator for determination. The Administrator, or an authorized representative, will issue a determination within 30 days of receipt and so advise the contracting officer or will notify the contracting officer within the 30-day period that additional time is necessary.

(5) The contracting officer must promptly notify the contractor of the action taken by the Wage and Hour Division

under paragraphs 1.c.(3) and (4) of this section. The contractor must furnish a written copy of such determination to each affected worker or it must be posted as a part of the wage determination. The wage rate (including fringe benefits where appropriate) determined pursuant to paragraph 1.c.(3) or (4) of this section must be paid to all workers performing work in the classification under this contract from the first day on which work is performed in the classification.

d. *Fringe benefits not expressed as an hourly rate.*

Whenever the minimum wage rate prescribed in the contract for a class of laborers or mechanics includes a fringe benefit which is not expressed as an hourly rate, the contractor may either pay the benefit as stated in the wage determination or may pay another bona fide fringe benefit or an hourly cash equivalent thereof.

e. *Unfunded plans.* If the contractor does not make payments to a trustee or other third person, the contractor may consider as part of the wages of any laborer or mechanic the amount of any costs reasonably anticipated in providing bona fide fringe benefits under a plan or program, *Provided*, That the Secretary of Labor has found, upon the written request of the contractor, in accordance with the criteria set forth in § 5.28, that the applicable standards of the Davis-Bacon Act have been met. The Secretary of Labor may require the contractor to set aside in a separate account assets for the meeting of obligations under the plan or program.

f. *Interest.* In the event of a failure to pay all or part of the wages required by the contract, the contractor will be required to pay interest on any underpayment of wages.

2. Withholding (29 CFR 5.5)

a. *Withholding requirements.* The contracting agency may, upon its own action, or must, upon written request of an authorized representative of the Department of Labor, withhold or cause to be withheld from the contractor so much of the accrued payments or advances as may be considered necessary to satisfy the liabilities of the prime contractor or any subcontractor for the full amount of wages and monetary relief, including interest, required by the clauses set forth in this section for violations of this contract, or to satisfy any such liabilities required by any other Federal contract, or federally assisted contract subject to Davis-Bacon labor standards, that is held by the same prime contractor (as defined in § 5.2). The necessary funds may be withheld from the contractor under this contract, any other Federal contract with the same prime contractor, or any other federally assisted contract that is subject to Davis-Bacon labor standards requirements and is held by the same prime contractor, regardless of whether the other contract was awarded or assisted by the same agency, and such funds may be used to satisfy the contractor liability for which the funds were withheld. In the event of a contractor's failure to pay any laborer or mechanic, including any apprentice or helper working on the site of the work all or part of the wages required by the contract, or upon the contractor's failure to submit the required records as discussed in paragraph 3.d. of this section, the contracting agency may on its own initiative and after written notice to the contractor, take such action as may be necessary to cause the suspension of any further payment, advance, or guarantee of funds until such violations have ceased.

b. *Priority to withheld funds.* The Department has priority to funds withheld or to be withheld in accordance with paragraph

2.a. of this section or Section V, paragraph 3.a., or both, over claims to those funds by:

- (1) A contractor's surety(ies), including without limitation performance bond sureties and payment bond sureties;
- (2) A contracting agency for its procurement costs;
- (3) A trustee(s) (either a court-appointed trustee or a U.S. trustee, or both) in bankruptcy of a contractor, or a contractor's bankruptcy estate;
- (4) A contractor's assignee(s);
- (5) A contractor's successor(s); or
- (6) A claim asserted under the Prompt Payment Act, [31 U.S.C. 3901–3907](#).

3. Records and certified payrolls (29 CFR 5.5)

a. Basic record requirements (1) Length of record retention. All regular payrolls and other basic records must be maintained by the contractor and any subcontractor during the course of the work and preserved for all laborers and mechanics working at the site of the work (or otherwise working in construction or development of the project under a development statute) for a period of at least 3 years after all the work on the prime contract is completed.

(2) Information required. Such records must contain the name; Social Security number; last known address, telephone number, and email address of each such worker; each worker's correct classification(s) of work actually performed; hourly rates of wages paid (including rates of contributions or costs anticipated for bona fide fringe benefits or cash equivalents thereof of the types described in [40 U.S.C. 3141\(2\)\(B\)](#) of the Davis-Bacon Act); daily and weekly number of hours actually worked in total and on each covered contract; deductions made; and actual wages paid.

(3) Additional records relating to fringe benefits. Whenever the Secretary of Labor has found under paragraph 1.e. of this section that the wages of any laborer or mechanic include the amount of any costs reasonably anticipated in providing benefits under a plan or program described in [40 U.S.C. 3141\(2\)\(B\)](#) of the Davis-Bacon Act, the contractor must maintain records which show that the commitment to provide such benefits is enforceable, that the plan or program is financially responsible, and that the plan or program has been communicated in writing to the laborers or mechanics affected, and records which show the costs anticipated or the actual cost incurred in providing such benefits.

(4) Additional records relating to apprenticeship. Contractors with apprentices working under approved programs must maintain written evidence of the registration of apprenticeship programs, the registration of the apprentices, and the ratios and wage rates prescribed in the applicable programs.

b. Certified payroll requirements (1) Frequency and method of submission. The contractor or subcontractor must submit weekly, for each week in which any DBA- or Related Acts-covered work is performed, certified payrolls to the contracting

agency. The prime contractor is responsible for the submission of all certified payrolls by all subcontractors. A contracting agency or prime contractor may permit or require contractors to submit certified payrolls through an electronic system, as long as the electronic system requires a legally valid electronic signature; the system allows the contractor, the contracting agency, and the Department of Labor to access the certified payrolls upon request for at least 3 years after the work on the prime contract has been completed; and the contracting agency or prime contractor permits other methods of submission in situations where the contractor is unable or limited in its ability to use or access the electronic system.

(2) Information required. The certified payrolls submitted must set out accurately and completely all of the information required to be maintained under paragraph 3.a.(2) of this section, except that full Social Security numbers and last known addresses, telephone numbers, and email addresses must not be included on weekly transmittals. Instead, the certified payrolls need only include an individually identifying number for each worker (e.g., the last four digits of the worker's Social Security number). The required weekly certified payroll information may be submitted using Optional Form WH-347 or in any other format desired. Optional Form WH-347 is available for this purpose from the Wage and Hour Division website at <https://www.dol.gov/sites/dolgov/files/WHDLegacy/files/wh347.pdf> or its successor website. It is not a violation of this section for a prime contractor to require a subcontractor to provide full Social Security numbers and last known addresses, telephone numbers, and email addresses to the prime contractor for its own records, without weekly submission by the subcontractor to the contracting agency.

(3) Statement of Compliance. Each certified payroll submitted must be accompanied by a "Statement of Compliance," signed by the contractor or subcontractor, or the contractor's or subcontractor's agent who pays or supervises the payment of the persons working on the contract, and must certify the following:

(i) That the certified payroll for the payroll period contains the information required to be provided under paragraph 3.b. of this section, the appropriate information and basic records are being maintained under paragraph 3.a. of this section, and such information and records are correct and complete;

(ii) That each laborer or mechanic (including each helper and apprentice) working on the contract during the payroll period has been paid the full weekly wages earned, without rebate, either directly or indirectly, and that no deductions have been made either directly or indirectly from the full wages earned, other than permissible deductions as set forth in [29 CFR part 3](#); and

(iii) That each laborer or mechanic has been paid not less than the applicable wage rates and fringe benefits or cash equivalents for the classification(s) of work actually performed, as specified in the applicable wage determination incorporated into the contract.

(4) Use of Optional Form WH-347. The weekly submission of a properly executed certification set forth on the reverse side of Optional Form WH-347 will satisfy the requirement for submission of the "Statement of Compliance" required by paragraph 3.b.(3) of this section.

(5) *Signature.* The signature by the contractor, subcontractor, or the contractor's or subcontractor's agent must be an original handwritten signature or a legally valid electronic signature.

(6) *Falsification.* The falsification of any of the above certifications may subject the contractor or subcontractor to civil or criminal prosecution under [18 U.S.C. 1001](#) and [31 U.S.C. 3729](#).

(7) *Length of certified payroll retention.* The contractor or subcontractor must preserve all certified payrolls during the course of the work and for a period of 3 years after all the work on the prime contract is completed.

c. *Contracts, subcontracts, and related documents.* The contractor or subcontractor must maintain this contract or subcontract and related documents including, without limitation, bids, proposals, amendments, modifications, and extensions. The contractor or subcontractor must preserve these contracts, subcontracts, and related documents during the course of the work and for a period of 3 years after all the work on the prime contract is completed.

d. *Required disclosures and access* (1) *Required record disclosures and access to workers.* The contractor or subcontractor must make the records required under paragraphs 3.a. through 3.c. of this section, and any other documents that the contracting agency, the State DOT, the FHWA, or the Department of Labor deems necessary to determine compliance with the labor standards provisions of any of the applicable statutes referenced by § 5.1, available for inspection, copying, or transcription by authorized representatives of the contracting agency, the State DOT, the FHWA, or the Department of Labor, and must permit such representatives to interview workers during working hours on the job.

(2) *Sanctions for non-compliance with records and worker access requirements.* If the contractor or subcontractor fails to submit the required records or to make them available, or refuses to permit worker interviews during working hours on the job, the Federal agency may, after written notice to the contractor, sponsor, applicant, owner, or other entity, as the case may be, that maintains such records or that employs such workers, take such action as may be necessary to cause the suspension of any further payment, advance, or guarantee of funds. Furthermore, failure to submit the required records upon request or to make such records available, or to permit worker interviews during working hours on the job, may be grounds for debarment action pursuant to § 5.12. In addition, any contractor or other person that fails to submit the required records or make those records available to WHD within the time WHD requests that the records be produced will be precluded from introducing as evidence in an administrative proceeding under [29 CFR part 6](#) any of the required records that were not provided or made available to WHD. WHD will take into consideration a reasonable request from the contractor or person for an extension of the time for submission of records. WHD will determine the reasonableness of the request and may consider, among other things, the location of the records and the volume of production.

(3) *Required information disclosures.* Contractors and subcontractors must maintain the full Social Security number and last known address, telephone number, and email address

of each covered worker, and must provide them upon request to the contracting agency, the State DOT, the FHWA, the contractor, or the Wage and Hour Division of the Department of Labor for purposes of an investigation or other compliance action.

4. Apprentices and equal employment opportunity (29 CFR 5.5)

a. *Apprentices (1) Rate of pay.* Apprentices will be permitted to work at less than the predetermined rate for the work they perform when they are employed pursuant to and individually registered in a bona fide apprenticeship program registered with the U.S. Department of Labor, Employment and Training Administration, Office of Apprenticeship (OA), or with a State Apprenticeship Agency recognized by the OA. A person who is not individually registered in the program, but who has been certified by the OA or a State Apprenticeship Agency (where appropriate) to be eligible for probationary employment as an apprentice, will be permitted to work at less than the predetermined rate for the work they perform in the first 90 days of probationary employment as an apprentice in such a program. In the event the OA or a State Apprenticeship Agency recognized by the OA withdraws approval of an apprenticeship program, the contractor will no longer be permitted to use apprentices at less than the applicable predetermined rate for the work performed until an acceptable program is approved.

(2) *Fringe benefits.* Apprentices must be paid fringe benefits in accordance with the provisions of the apprenticeship program. If the apprenticeship program does not specify fringe benefits, apprentices must be paid the full amount of fringe benefits listed on the wage determination for the applicable classification. If the Administrator determines that a different practice prevails for the applicable apprentice classification, fringe benefits must be paid in accordance with that determination.

(3) *Apprenticeship ratio.* The allowable ratio of apprentices to journeyworkers on the job site in any craft classification must not be greater than the ratio permitted to the contractor as to the entire work force under the registered program or the ratio applicable to the locality of the project pursuant to paragraph 4.a.(4) of this section. Any worker listed on a payroll at an apprentice wage rate, who is not registered or otherwise employed as stated in paragraph 4.a.(1) of this section, must be paid not less than the applicable wage rate on the wage determination for the classification of work actually performed. In addition, any apprentice performing work on the job site in excess of the ratio permitted under this section must be paid not less than the applicable wage rate on the wage determination for the work actually performed.

(4) *Reciprocity of ratios and wage rates.* Where a contractor is performing construction on a project in a locality other than the locality in which its program is registered, the ratios and wage rates (expressed in percentages of the journeyworker's hourly rate) applicable within the locality in which the construction is being performed must be observed. If there is no applicable ratio or wage rate for the locality of the project, the ratio and wage rate specified in the contractor's registered program must be observed.

b. *Equal employment opportunity.* The use of apprentices and journeyworkers under this part must be in conformity with

the equal employment opportunity requirements of Executive Order 11246, as amended, and [29 CFR part 30](#).

c. Apprentices and Trainees (programs of the U.S. DOT).

Apprentices and trainees working under apprenticeship and skill training programs which have been certified by the Secretary of Transportation as promoting EEO in connection with Federal-aid highway construction programs are not subject to the requirements of paragraph 4 of this Section IV. 23 CFR 230.111(e)(2). The straight time hourly wage rates for apprentices and trainees under such programs will be established by the particular programs. The ratio of apprentices and trainees to journeyworkers shall not be greater than permitted by the terms of the particular program.

5. Compliance with Copeland Act requirements. The contractor shall comply with the requirements of 29 CFR part 3, which are incorporated by reference in this contract as provided in 29 CFR 5.5.

6. Subcontracts. The contractor or subcontractor must insert FHWA-1273 in any subcontracts, along with the applicable wage determination(s) and such other clauses or contract modifications as the contracting agency may by appropriate instructions require, and a clause requiring the subcontractors to include these clauses and wage determination(s) in any lower tier subcontracts. The prime contractor is responsible for the compliance by any subcontractor or lower tier subcontractor with all the contract clauses in this section. In the event of any violations of these clauses, the prime contractor and any subcontractor(s) responsible will be liable for any unpaid wages and monetary relief, including interest from the date of the underpayment or loss, due to any workers of lower-tier subcontractors, and may be subject to debarment, as appropriate. 29 CFR 5.5.

7. Contract termination: debarment. A breach of the contract clauses in 29 CFR 5.5 may be grounds for termination of the contract, and for debarment as a contractor and a subcontractor as provided in 29 CFR 5.12.

8. Compliance with Davis-Bacon and Related Act requirements. All rulings and interpretations of the Davis-Bacon and Related Acts contained in 29 CFR parts 1, 3, and 5 are herein incorporated by reference in this contract as provided in 29 CFR 5.5.

9. Disputes concerning labor standards. As provided in 29 CFR 5.5, disputes arising out of the labor standards provisions of this contract shall not be subject to the general disputes clause of this contract. Such disputes shall be resolved in accordance with the procedures of the Department of Labor set forth in 29 CFR parts 5, 6, and 7. Disputes within the meaning of this clause include disputes between the contractor (or any of its subcontractors) and the contracting agency, the U.S. Department of Labor, or the employees or their representatives.

10. Certification of eligibility. a. By entering into this contract, the contractor certifies that neither it nor any person or firm who has an interest in the contractor's firm is a person or firm ineligible to be awarded Government contracts by virtue of [40 U.S.C. 3144\(b\)](#) or § 5.12(a).

b. No part of this contract shall be subcontracted to any person or firm ineligible for award of a Government contract by virtue of [40 U.S.C. 3144\(b\)](#) or § 5.12(a).

c. The penalty for making false statements is prescribed in the U.S. Code, Title 18 Crimes and Criminal Procedure, [18 U.S.C. 1001](#).

11. Anti-retaliation. It is unlawful for any person to discharge, demote, intimidate, threaten, restrain, coerce, blacklist, harass, or in any other manner discriminate against, or to cause any person to discharge, demote, intimidate, threaten, restrain, coerce, blacklist, harass, or in any other manner discriminate against, any worker or job applicant for:

a. Notifying any contractor of any conduct which the worker reasonably believes constitutes a violation of the DBA, Related Acts, this part, or [29 CFR part 1](#) or [3](#);

b. Filing any complaint, initiating or causing to be initiated any proceeding, or otherwise asserting or seeking to assert on behalf of themselves or others any right or protection under the DBA, Related Acts, this part, or [29 CFR part 1](#) or [3](#);

c. Cooperating in any investigation or other compliance action, or testifying in any proceeding under the DBA, Related Acts, this part, or [29 CFR part 1](#) or [3](#); or

d. Informing any other person about their rights under the DBA, Related Acts, this part, or [29 CFR part 1](#) or [3](#).

V. CONTRACT WORK HOURS AND SAFETY STANDARDS ACT

Pursuant to 29 CFR 5.5(b), the following clauses apply to any Federal-aid construction contract in an amount in excess of \$100,000 and subject to the overtime provisions of the Contract Work Hours and Safety Standards Act. These clauses shall be inserted in addition to the clauses required by 29 CFR 5.5(a) or 29 CFR 4.6. As used in this paragraph, the terms laborers and mechanics include watchpersons and guards.

1. Overtime requirements. No contractor or subcontractor contracting for any part of the contract work which may require or involve the employment of laborers or mechanics shall require or permit any such laborer or mechanic in any workweek in which he or she is employed on such work to work in excess of forty hours in such workweek unless such laborer or mechanic receives compensation at a rate not less than one and one-half times the basic rate of pay for all hours worked in excess of forty hours in such workweek. 29 CFR 5.5.

2. Violation; liability for unpaid wages; liquidated damages. In the event of any violation of the clause set forth in paragraph 1. of this section the contractor and any subcontractor responsible therefor shall be liable for the unpaid wages and interest from the date of the underpayment. In addition, such contractor and subcontractor shall be liable to the United States (in the case of work done under contract for the District of Columbia or a territory, to such District or to such territory), for liquidated damages. Such liquidated damages shall be computed with respect to each individual laborer or

mechanic, including watchpersons and guards, employed in violation of the clause set forth in paragraph 1. of this section, in the sum currently provided in 29 CFR 5.5(b)(2)* for each calendar day on which such individual was required or permitted to work in excess of the standard workweek of forty hours without payment of the overtime wages required by the clause set forth in paragraph 1. of this section.

* \$31 as of January 15, 2023 (See 88 FR 88 FR 2210) as may be adjusted annually by the Department of Labor, pursuant to the Federal Civil Penalties Inflation Adjustment Act of 1990.

3. Withholding for unpaid wages and liquidated damages

a. *Withholding process.* The FHWA or the contracting agency may, upon its own action, or must, upon written request of an authorized representative of the Department of Labor, withhold or cause to be withheld from the contractor so much of the accrued payments or advances as may be considered necessary to satisfy the liabilities of the prime contractor or any subcontractor for any unpaid wages; monetary relief, including interest; and liquidated damages required by the clauses set forth in this section on this contract, any other Federal contract with the same prime contractor, or any other federally assisted contract subject to the Contract Work Hours and Safety Standards Act that is held by the same prime contractor (as defined in § 5.2). The necessary funds may be withheld from the contractor under this contract, any other Federal contract with the same prime contractor, or any other federally assisted contract that is subject to the Contract Work Hours and Safety Standards Act and is held by the same prime contractor, regardless of whether the other contract was awarded or assisted by the same agency, and such funds may be used to satisfy the contractor liability for which the funds were withheld.

b. *Priority to withheld funds.* The Department has priority to funds withheld or to be withheld in accordance with Section IV paragraph 2.a. or paragraph 3.a. of this section, or both, over claims to those funds by:

- (1) A contractor's surety(ies), including without limitation performance bond sureties and payment bond sureties;
- (2) A contracting agency for its procurement costs;
- (3) A trustee(s) (either a court-appointed trustee or a U.S. trustee, or both) in bankruptcy of a contractor, or a contractor's bankruptcy estate;
- (4) A contractor's assignee(s);
- (5) A contractor's successor(s); or
- (6) A claim asserted under the Prompt Payment Act, [31 U.S.C. 3901](#)–3907.

4. Subcontracts. The contractor or subcontractor must insert in any subcontracts the clauses set forth in paragraphs 1. through 5. of this section and a clause requiring the subcontractors to include these clauses in any lower tier subcontracts. The prime contractor is responsible for compliance by any subcontractor or lower tier subcontractor with the clauses set forth in paragraphs 1. through 5. In the

event of any violations of these clauses, the prime contractor and any subcontractor(s) responsible will be liable for any unpaid wages and monetary relief, including interest from the date of the underpayment or loss, due to any workers of lower-tier subcontractors, and associated liquidated damages and may be subject to debarment, as appropriate.

5. Anti-retaliation. It is unlawful for any person to discharge, demote, intimidate, threaten, restrain, coerce, blacklist, harass, or in any other manner discriminate against, or to cause any person to discharge, demote, intimidate, threaten, restrain, coerce, blacklist, harass, or in any other manner discriminate against, any worker or job applicant for:

- a. Notifying any contractor of any conduct which the worker reasonably believes constitutes a violation of the Contract Work Hours and Safety Standards Act (CWHSSA) or its implementing regulations in this part;
- b. Filing any complaint, initiating or causing to be initiated any proceeding, or otherwise asserting or seeking to assert on behalf of themselves or others any right or protection under CWHSSA or this part;
- c. Cooperating in any investigation or other compliance action, or testifying in any proceeding under CWHSSA or this part; or
- d. Informing any other person about their rights under CWHSSA or this part.

VI. SUBLETTING OR ASSIGNING THE CONTRACT

This provision is applicable to all Federal-aid construction contracts on the National Highway System pursuant to 23 CFR 635.116.

1. The contractor shall perform with its own organization contract work amounting to not less than 30 percent (or a greater percentage if specified elsewhere in the contract) of the total original contract price, excluding any specialty items designated by the contracting agency. Specialty items may be performed by subcontract and the amount of any such specialty items performed may be deducted from the total original contract price before computing the amount of work required to be performed by the contractor's own organization (23 CFR 635.116).

a. The term "perform work with its own organization" in paragraph 1 of Section VI refers to workers employed or leased by the prime contractor, and equipment owned or rented by the prime contractor, with or without operators. Such term does not include employees or equipment of a subcontractor or lower tier subcontractor, agents of the prime contractor, or any other assignees. The term may include payments for the costs of hiring leased employees from an employee leasing firm meeting all relevant Federal and State regulatory requirements. Leased employees may only be included in this term if the prime contractor meets all of the following conditions: (based on longstanding interpretation)

- (1) the prime contractor maintains control over the supervision of the day-to-day activities of the leased employees;
- (2) the prime contractor remains responsible for the quality of the work of the leased employees;

- (3) the prime contractor retains all power to accept or exclude individual employees from work on the project; and
- (4) the prime contractor remains ultimately responsible for the payment of predetermined minimum wages, the submission of payrolls, statements of compliance and all other Federal regulatory requirements.

b. "Specialty Items" shall be construed to be limited to work that requires highly specialized knowledge, abilities, or equipment not ordinarily available in the type of contracting organizations qualified and expected to bid or propose on the contract as a whole and in general are to be limited to minor components of the overall contract. 23 CFR 635.102.

2. Pursuant to 23 CFR 635.116(a), the contract amount upon which the requirements set forth in paragraph (1) of Section VI is computed includes the cost of material and manufactured products which are to be purchased or produced by the contractor under the contract provisions.

3. Pursuant to 23 CFR 635.116(c), the contractor shall furnish (a) a competent superintendent or supervisor who is employed by the firm, has full authority to direct performance of the work in accordance with the contract requirements, and is in charge of all construction operations (regardless of who performs the work) and (b) such other of its own organizational resources (supervision, management, and engineering services) as the contracting officer determines is necessary to assure the performance of the contract.

4. No portion of the contract shall be sublet, assigned or otherwise disposed of except with the written consent of the contracting officer, or authorized representative, and such consent when given shall not be construed to relieve the contractor of any responsibility for the fulfillment of the contract. Written consent will be given only after the contracting agency has assured that each subcontract is evidenced in writing and that it contains all pertinent provisions and requirements of the prime contract. (based on long-standing interpretation of 23 CFR 635.116).

5. The 30-percent self-performance requirement of paragraph (1) is not applicable to design-build contracts; however, contracting agencies may establish their own self-performance requirements. 23 CFR 635.116(d).

VII. SAFETY: ACCIDENT PREVENTION

This provision is applicable to all Federal-aid construction contracts and to all related subcontracts.

1. In the performance of this contract the contractor shall comply with all applicable Federal, State, and local laws governing safety, health, and sanitation (23 CFR Part 635). The contractor shall provide all safeguards, safety devices and protective equipment and take any other needed actions as it determines, or as the contracting officer may determine, to be reasonably necessary to protect the life and health of employees on the job and the safety of the public and to protect property in connection with the performance of the work covered by the contract. 23 CFR 635.108.

2. It is a condition of this contract, and shall be made a condition of each subcontract, which the contractor enters into pursuant to this contract, that the contractor and any subcontractor shall not permit any employee, in performance of the contract, to work in surroundings or under conditions which are unsanitary, hazardous or dangerous to his/her health or safety, as determined under construction safety and

health standards (29 CFR Part 1926) promulgated by the Secretary of Labor, in accordance with Section 107 of the Contract Work Hours and Safety Standards Act (40 U.S.C. 3704). 29 CFR 1926.10.

3. Pursuant to 29 CFR 1926.3, it is a condition of this contract that the Secretary of Labor or authorized representative thereof, shall have right of entry to any site of contract performance to inspect or investigate the matter of compliance with the construction safety and health standards and to carry out the duties of the Secretary under Section 107 of the Contract Work Hours and Safety Standards Act (40 U.S.C. 3704).

VIII. FALSE STATEMENTS CONCERNING HIGHWAY PROJECTS

This provision is applicable to all Federal-aid construction contracts and to all related subcontracts.

In order to assure high quality and durable construction in conformity with approved plans and specifications and a high degree of reliability on statements and representations made by engineers, contractors, suppliers, and workers on Federal-aid highway projects, it is essential that all persons concerned with the project perform their functions as carefully, thoroughly, and honestly as possible. Willful falsification, distortion, or misrepresentation with respect to any facts related to the project is a violation of Federal law. To prevent any misunderstanding regarding the seriousness of these and similar acts, Form FHWA-1022 shall be posted on each Federal-aid highway project (23 CFR Part 635) in one or more places where it is readily available to all persons concerned with the project:

18 U.S.C. 1020 reads as follows:

"Whoever, being an officer, agent, or employee of the United States, or of any State or Territory, or whoever, whether a person, association, firm, or corporation, knowingly makes any false statement, false representation, or false report as to the character, quality, quantity, or cost of the material used or to be used, or the quantity or quality of the work performed or to be performed, or the cost thereof in connection with the submission of plans, maps, specifications, contracts, or costs of construction on any highway or related project submitted for approval to the Secretary of Transportation; or

Whoever knowingly makes any false statement, false representation, false report or false claim with respect to the character, quality, quantity, or cost of any work performed or to be performed, or materials furnished or to be furnished, in connection with the construction of any highway or related project approved by the Secretary of Transportation; or

Whoever knowingly makes any false statement or false representation as to material fact in any statement, certificate, or report submitted pursuant to provisions of the Federal-aid Roads Act approved July 11, 1916, (39 Stat. 355), as amended and supplemented;

Shall be fined under this title or imprisoned not more than 5 years or both."

IX. IMPLEMENTATION OF CLEAN AIR ACT AND FEDERAL WATER POLLUTION CONTROL ACT (42 U.S.C. 7606; 2 CFR 200.88; EO 11738)

This provision is applicable to all Federal-aid construction contracts in excess of \$150,000 and to all related subcontracts. 48 CFR 2.101; 2 CFR 200.327.

By submission of this bid/proposal or the execution of this contract or subcontract, as appropriate, the bidder, proposer, Federal-aid construction contractor, subcontractor, supplier, or vendor agrees to comply with all applicable standards, orders or regulations issued pursuant to the Clean Air Act (42 U.S.C. 7401-7671q) and the Federal Water Pollution Control Act, as amended (33 U.S.C. 1251-1387). Violations must be reported to the Federal Highway Administration and the Regional Office of the Environmental Protection Agency. 2 CFR Part 200, Appendix II.

The contractor agrees to include or cause to be included the requirements of this Section in every subcontract, and further agrees to take such action as the contracting agency may direct as a means of enforcing such requirements. 2 CFR 200.327.

X. CERTIFICATION REGARDING DEBARMENT, SUSPENSION, INELIGIBILITY AND VOLUNTARY EXCLUSION

This provision is applicable to all Federal-aid construction contracts, design-build contracts, subcontracts, lower-tier subcontracts, purchase orders, lease agreements, consultant contracts or any other covered transaction requiring FHWA approval or that is estimated to cost \$25,000 or more – as defined in 2 CFR Parts 180 and 1200. 2 CFR 180.220 and 1200.220.

1. Instructions for Certification – First Tier Participants:

a. By signing and submitting this proposal, the prospective first tier participant is providing the certification set out below.

b. The inability of a person to provide the certification set out below will not necessarily result in denial of participation in this covered transaction. The prospective first tier participant shall submit an explanation of why it cannot provide the certification set out below. The certification or explanation will be considered in connection with the department or agency's determination whether to enter into this transaction. However, failure of the prospective first tier participant to furnish a certification or an explanation shall disqualify such a person from participation in this transaction. 2 CFR 180.320.

c. The certification in this clause is a material representation of fact upon which reliance was placed when the contracting agency determined to enter into this transaction. If it is later determined that the prospective participant knowingly rendered an erroneous certification, in addition to other remedies available to the Federal Government, the contracting agency may terminate this transaction for cause of default. 2 CFR 180.325.

d. The prospective first tier participant shall provide immediate written notice to the contracting agency to whom this proposal is submitted if any time the prospective first tier participant learns that its certification was erroneous when submitted or has become erroneous by reason of changed circumstances. 2 CFR 180.345 and 180.350.

e. The terms "covered transaction," "debarred," "suspended," "ineligible," "participant," "person," "principal," and "voluntarily excluded," as used in this clause, are defined in 2 CFR Parts 180, Subpart I, 180.900-180.1020, and 1200. "First Tier Covered Transactions" refers to any covered transaction between a recipient or subrecipient of Federal funds and a participant (such as the prime or general contract). "Lower Tier Covered Transactions" refers to any covered transaction under a First Tier Covered Transaction (such as subcontracts). "First Tier Participant" refers to the participant who has entered into a covered transaction with a recipient or subrecipient of Federal funds (such as the prime or general contractor). "Lower Tier Participant" refers any participant who has entered into a covered transaction with a First Tier Participant or other Lower Tier Participants (such as subcontractors and suppliers).

f. The prospective first tier participant agrees by submitting this proposal that, should the proposed covered transaction be entered into, it shall not knowingly enter into any lower tier covered transaction with a person who is debarred, suspended, declared ineligible, or voluntarily excluded from participation in this covered transaction, unless authorized by the department or agency entering into this transaction. 2 CFR 180.330.

g. The prospective first tier participant further agrees by submitting this proposal that it will include the clause titled "Certification Regarding Debarment, Suspension, Ineligibility and Voluntary Exclusion-Lower Tier Covered Transactions," provided by the department or contracting agency, entering into this covered transaction, without modification, in all lower tier covered transactions and in all solicitations for lower tier covered transactions exceeding the \$25,000 threshold. 2 CFR 180.220 and 180.300.

h. A participant in a covered transaction may rely upon a certification of a prospective participant in a lower tier covered transaction that is not debarred, suspended, ineligible, or voluntarily excluded from the covered transaction, unless it knows that the certification is erroneous. 2 CFR 180.300; 180.320, and 180.325. A participant is responsible for ensuring that its principals are not suspended, debarred, or otherwise ineligible to participate in covered transactions. 2 CFR 180.335. To verify the eligibility of its principals, as well as the eligibility of any lower tier prospective participants, each participant may, but is not required to, check the System for Award Management website (<https://www.sam.gov/>). 2 CFR 180.300, 180.320, and 180.325.

i. Nothing contained in the foregoing shall be construed to require the establishment of a system of records in order to render in good faith the certification required by this clause. The knowledge and information of the prospective participant is not required to exceed that which is normally possessed by a prudent person in the ordinary course of business dealings.

j. Except for transactions authorized under paragraph (f) of these instructions, if a participant in a covered transaction knowingly enters into a lower tier covered transaction with a person who is suspended, debarred, ineligible, or voluntarily excluded from participation in this transaction, in addition to other remedies available to the Federal Government, the department or agency may terminate this transaction for cause or default. 2 CFR 180.325.

* * * * *

2. Certification Regarding Debarment, Suspension, Ineligibility and Voluntary Exclusion – First Tier Participants:

a. The prospective first tier participant certifies to the best of its knowledge and belief, that it and its principals:

(1) Are not presently debarred, suspended, proposed for debarment, declared ineligible, or voluntarily excluded from participating in covered transactions by any Federal department or agency, 2 CFR 180.335;

(2) Have not within a three-year period preceding this proposal been convicted of or had a civil judgment rendered against them for commission of fraud or a criminal offense in connection with obtaining, attempting to obtain, or performing a public (Federal, State, or local) transaction or contract under a public transaction; violation of Federal or State antitrust statutes or commission of embezzlement, theft, forgery, bribery, falsification or destruction of records, making false statements, or receiving stolen property, 2 CFR 180.800;

(3) Are not presently indicted for or otherwise criminally or civilly charged by a governmental entity (Federal, State or local) with commission of any of the offenses enumerated in paragraph (a)(2) of this certification, 2 CFR 180.700 and 180.800; and

(4) Have not within a three-year period preceding this application/proposal had one or more public transactions (Federal, State or local) terminated for cause or default. 2 CFR 180.335(d).

(5) Are not a corporation that has been convicted of a felony violation under any Federal law within the two-year period preceding this proposal (USDOT Order 4200.6 implementing appropriations act requirements); and

(6) Are not a corporation with any unpaid Federal tax liability that has been assessed, for which all judicial and administrative remedies have been exhausted, or have lapsed, and that is not being paid in a timely manner pursuant to an agreement with the authority responsible for collecting the tax liability (USDOT Order 4200.6 implementing appropriations act requirements).

b. Where the prospective participant is unable to certify to any of the statements in this certification, such prospective participant should attach an explanation to this proposal. 2 CFR 180.335 and 180.340.

* * * * *

3. Instructions for Certification - Lower Tier Participants:

(Applicable to all subcontracts, purchase orders, and other lower tier transactions requiring prior FHWA approval or estimated to cost \$25,000 or more - 2 CFR Parts 180 and 1200). 2 CFR 180.220 and 1200.220.

a. By signing and submitting this proposal, the prospective lower tier participant is providing the certification set out below.

b. The certification in this clause is a material representation of fact upon which reliance was placed when this transaction was entered into. If it is later determined that the prospective lower tier participant knowingly rendered an erroneous certification, in addition to other remedies available to the Federal Government, the department, or agency with which

this transaction originated may pursue available remedies, including suspension and/or debarment.

c. The prospective lower tier participant shall provide immediate written notice to the person to which this proposal is submitted if at any time the prospective lower tier participant learns that its certification was erroneous by reason of changed circumstances. 2 CFR 180.365.

d. The terms "covered transaction," "debarred," "suspended," "ineligible," "participant," "person," "principal," and "voluntarily excluded," as used in this clause, are defined in 2 CFR Parts 180, Subpart I, 180.900 – 180.1020, and 1200. You may contact the person to which this proposal is submitted for assistance in obtaining a copy of those regulations. "First Tier Covered Transactions" refers to any covered transaction between a recipient or subrecipient of Federal funds and a participant (such as the prime or general contract). "Lower Tier Covered Transactions" refers to any covered transaction under a First Tier Covered Transaction (such as subcontracts). "First Tier Participant" refers to the participant who has entered into a covered transaction with a recipient or subrecipient of Federal funds (such as the prime or general contractor). "Lower Tier Participant" refers any participant who has entered into a covered transaction with a First Tier Participant or other Lower Tier Participants (such as subcontractors and suppliers).

e. The prospective lower tier participant agrees by submitting this proposal that, should the proposed covered transaction be entered into, it shall not knowingly enter into any lower tier covered transaction with a person who is debarred, suspended, declared ineligible, or voluntarily excluded from participation in this covered transaction, unless authorized by the department or agency with which this transaction originated. 2 CFR 1200.220 and 1200.332.

f. The prospective lower tier participant further agrees by submitting this proposal that it will include this clause titled "Certification Regarding Debarment, Suspension, Ineligibility and Voluntary Exclusion-Lower Tier Covered Transaction," without modification, in all lower tier covered transactions and in all solicitations for lower tier covered transactions exceeding the \$25,000 threshold. 2 CFR 180.220 and 1200.220.

g. A participant in a covered transaction may rely upon a certification of a prospective participant in a lower tier covered transaction that is not debarred, suspended, ineligible, or voluntarily excluded from the covered transaction, unless it knows that the certification is erroneous. A participant is responsible for ensuring that its principals are not suspended, debarred, or otherwise ineligible to participate in covered transactions. To verify the eligibility of its principals, as well as the eligibility of any lower tier prospective participants, each participant may, but is not required to, check the System for Award Management website (<https://www.sam.gov>), which is compiled by the General Services Administration. 2 CFR 180.300, 180.320, 180.330, and 180.335.

h. Nothing contained in the foregoing shall be construed to require establishment of a system of records in order to render in good faith the certification required by this clause. The knowledge and information of participant is not required to exceed that which is normally possessed by a prudent person in the ordinary course of business dealings.

i. Except for transactions authorized under paragraph e of these instructions, if a participant in a covered transaction knowingly enters into a lower tier covered transaction with a person who is suspended, debarred, ineligible, or voluntarily

excluded from participation in this transaction, in addition to other remedies available to the Federal Government, the department or agency with which this transaction originated may pursue available remedies, including suspension and/or debarment. 2 CFR 180.325.

* * * * *

4. Certification Regarding Debarment, Suspension, Ineligibility and Voluntary Exclusion--Lower Tier Participants:

a. The prospective lower tier participant certifies, by submission of this proposal, that neither it nor its principals:

(1) is presently debarred, suspended, proposed for debarment, declared ineligible, or voluntarily excluded from participating in covered transactions by any Federal department or agency, 2 CFR 180.355;

(2) is a corporation that has been convicted of a felony violation under any Federal law within the two-year period preceding this proposal (USDOT Order 4200.6 implementing appropriations act requirements); and

(3) is a corporation with any unpaid Federal tax liability that has been assessed, for which all judicial and administrative remedies have been exhausted, or have lapsed, and that is not being paid in a timely manner pursuant to an agreement with the authority responsible for collecting the tax liability. (USDOT Order 4200.6 implementing appropriations act requirements)

b. Where the prospective lower tier participant is unable to certify to any of the statements in this certification, such prospective participant should attach an explanation to this proposal.

* * * * *

XI. CERTIFICATION REGARDING USE OF CONTRACT FUNDS FOR LOBBYING

This provision is applicable to all Federal-aid construction contracts and to all related subcontracts which exceed \$100,000. 49 CFR Part 20, App. A.

1. The prospective participant certifies, by signing and submitting this bid or proposal, to the best of his or her knowledge and belief, that:

a. No Federal appropriated funds have been paid or will be paid, by or on behalf of the undersigned, to any person for influencing or attempting to influence an officer or employee of any Federal agency, a Member of Congress, an officer or employee of Congress, or an employee of a Member of Congress in connection with the awarding of any Federal contract, the making of any Federal grant, the making of any Federal loan, the entering into of any cooperative agreement, and the extension, continuation, renewal, amendment, or modification of any Federal contract, grant, loan, or cooperative agreement.

b. If any funds other than Federal appropriated funds have been paid or will be paid to any person for influencing or attempting to influence an officer or employee of any Federal agency, a Member of Congress, an officer or employee of Congress, or an employee of a Member of Congress in connection with this Federal contract, grant, loan, or

cooperative agreement, the undersigned shall complete and submit Standard Form-LLL, "Disclosure Form to Report Lobbying," in accordance with its instructions.

2. This certification is a material representation of fact upon which reliance was placed when this transaction was made or entered into. Submission of this certification is a prerequisite for making or entering into this transaction imposed by 31 U.S.C. 1352. Any person who fails to file the required certification shall be subject to a civil penalty of not less than \$10,000 and not more than \$100,000 for each such failure.

3. The prospective participant also agrees by submitting its bid or proposal that the participant shall require that the language of this certification be included in all lower tier subcontracts, which exceed \$100,000 and that all such recipients shall certify and disclose accordingly.

XII. USE OF UNITED STATES-FLAG VESSELS:

This provision is applicable to all Federal-aid construction contracts, design-build contracts, subcontracts, lower-tier subcontracts, purchase orders, lease agreements, or any other covered transaction. 46 CFR Part 381.

This requirement applies to material or equipment that is acquired for a specific Federal-aid highway project. 46 CFR 381.7. It is not applicable to goods or materials that come into inventories independent of an FHWA funded-contract.

When oceanic shipments (or shipments across the Great Lakes) are necessary for materials or equipment acquired for a specific Federal-aid construction project, the bidder, proposer, contractor, subcontractor, or vendor agrees:

1. To utilize privately owned United States-flag commercial vessels to ship at least 50 percent of the gross tonnage (computed separately for dry bulk carriers, dry cargo liners, and tankers) involved, whenever shipping any equipment, material, or commodities pursuant to this contract, to the extent such vessels are available at fair and reasonable rates for United States-flag commercial vessels. 46 CFR 381.7.

2. To furnish within 20 days following the date of loading for shipments originating within the United States or within 30 working days following the date of loading for shipments originating outside the United States, a legible copy of a rated, 'on-board' commercial ocean bill-of-lading in English for each shipment of cargo described in paragraph (b)(1) of this section to both the Contracting Officer (through the prime contractor in the case of subcontractor bills-of-lading) and to the Office of Cargo and Commercial Sealift (MAR-620), Maritime Administration, Washington, DC 20590. (MARAD requires copies of the ocean carrier's (master) bills of lading, certified onboard, dated, with rates and charges. These bills of lading may contain business sensitive information and therefore may be submitted directly to MARAD by the Ocean Transportation Intermediary on behalf of the contractor). 46 CFR 381.7.

**ATTACHMENT A - EMPLOYMENT AND MATERIALS
PREFERENCE FOR APPALACHIAN DEVELOPMENT HIGHWAY
SYSTEM OR APPALACHIAN LOCAL ACCESS**

ROAD CONTRACTS (23 CFR 633, Subpart B, Appendix B)
This provision is applicable to all Federal-aid projects funded under the Appalachian Regional Development Act of 1965.

1. During the performance of this contract, the contractor undertaking to do work which is, or reasonably may be, done as on-site work, shall give preference to qualified persons who regularly reside in the labor area as designated by the DOL wherein the contract work is situated, or the subregion, or the Appalachian counties of the State wherein the contract work is situated, except:

a. To the extent that qualified persons regularly residing in the area are not available.

b. For the reasonable needs of the contractor to employ supervisory or specially experienced personnel necessary to assure an efficient execution of the contract work.

c. For the obligation of the contractor to offer employment to present or former employees as the result of a lawful collective bargaining contract, provided that the number of nonresident persons employed under this subparagraph (1c) shall not exceed 20 percent of the total number of employees employed by the contractor on the contract work, except as provided in subparagraph (4) below.

2. The contractor shall place a job order with the State Employment Service indicating (a) the classifications of the laborers, mechanics and other employees required to perform the contract work, (b) the number of employees required in each classification, (c) the date on which the participant estimates such employees will be required, and (d) any other pertinent information required by the State Employment Service to complete the job order form. The job order may be placed with the State Employment Service in writing or by telephone. If during the course of the contract work, the information submitted by the contractor in the original job order is substantially modified, the participant shall promptly notify the State Employment Service.

3. The contractor shall give full consideration to all qualified job applicants referred to him by the State Employment Service. The contractor is not required to grant employment to any job applicants who, in his opinion, are not qualified to perform the classification of work required.

4. If, within one week following the placing of a job order by the contractor with the State Employment Service, the State Employment Service is unable to refer any qualified job applicants to the contractor, or less than the number requested, the State Employment Service will forward a certificate to the contractor indicating the unavailability of applicants. Such certificate shall be made a part of the contractor's permanent project records. Upon receipt of this certificate, the contractor may employ persons who do not normally reside in the labor area to fill positions covered by the certificate, notwithstanding the provisions of subparagraph (1c) above.

5. The provisions of 23 CFR 633.207(e) allow the contracting agency to provide a contractual preference for the use of mineral resource materials native to the Appalachian region.

6. The contractor shall include the provisions of Sections 1 through 4 of this Attachment A in every subcontract for work which is, or reasonably may be, done as on-site work.