

**ELEVATION - FLOORBEAM L17 (SHOWN)**  
**ELEVATION - FLOORBEAM L17' (SIMILAR)**

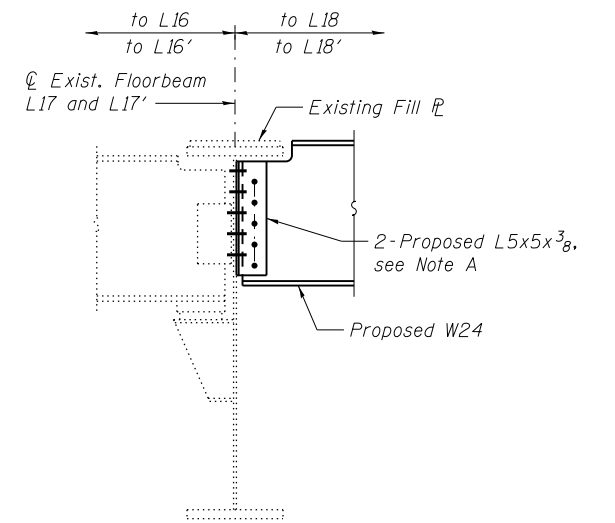

**SECTION A-A**

Note A:  
 Field drill holes using existing holes as template. Remainder of holes may be shop or field drilled.

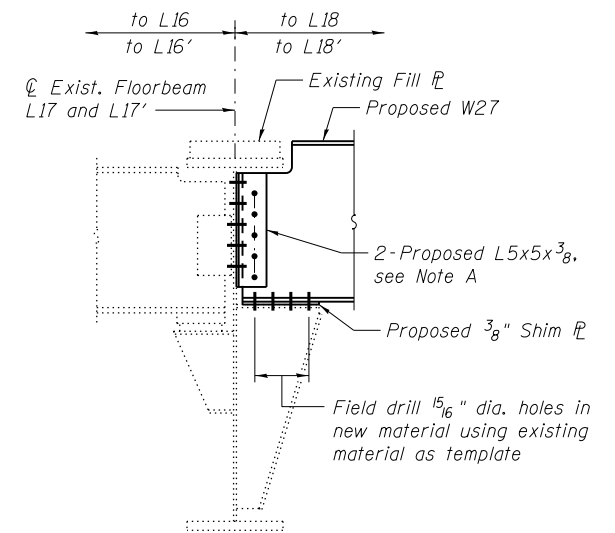

**SECTION B-B**

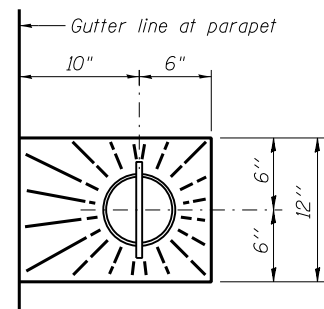

**TOP PLAN**

Cut grid deck cross and supplemental bars as required for placing anchor bolts. Do not cut bearing bars.

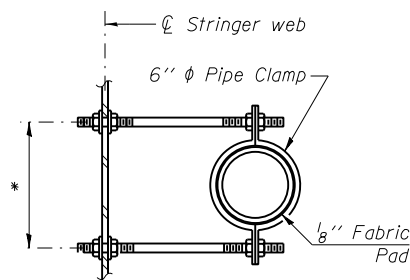

**SECTION THRU PIPE AT STRINGER CONNECTION**

\*Dimension as required by Pipe Clamp

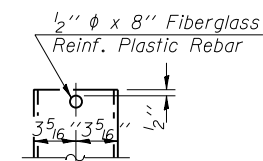

**FIBERGLASS PIPE**

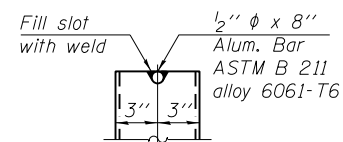

**ALUMINUM TUBE**

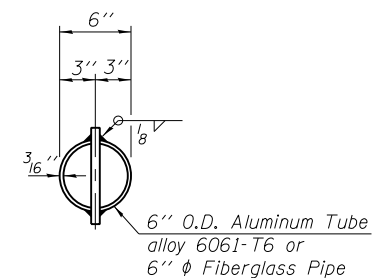

**TOP PLAN (Showing Aluminum Tube)**

**FLOOR DRAIN DETAILS**

**Floor Drain Notes:**

The exterior surfaces of the floor drains shall be painted with the finish coat as specified in the special provisions for Cleaning and Painting New Metal Structures. The exterior surfaces of the drains shall be cleaned according to Society of Protective Coatings Spec. SSPC-SP1 prior to painting.

Fiberglass pipe shall conform to ASTM D 2996, with short-time rupture strength hoop tensile stress of 30,000 p.s.i. minimum.

Galvanize clamping device according to AASHTO M232. Cost of clamping device and inserts is included with Floor Drains.

Note:  
 Cost of stringer connection angles and shim plates shall be included in Furnishing and Erecting Structural Steel.



USER NAME =	DESIGNED - YSS	REVISED
	CHECKED - ZJB	REVISED
PLOT SCALE =	DRAWN - PRC	REVISED
PLOT DATE = 05/02/2014	CHECKED - YSS	REVISED

STATE OF ILLINOIS  
 DEPARTMENT OF TRANSPORTATION

MAIN SPANS GRID DECK FRAMING DETAILS - 1  
 S.N. 082-6001 MLK BRIDGE OVER MISSISSIPPI RIVER

SHEET NO. S17 OF S138 SHEETS

F.A.P. RTE.	SECTION	COUNTY	TOTAL SHEETS	SHEET NO.
799	IBR, DRS-2	ST. CLAIR	156	35
CONTRACT NO. 76B03				

ILLINOIS FED. AID PROJECT