

F.A.I. RTE.	SECTION	COUNTY	TOTAL SHEETS	SHEET NO.
*	2023 VAR SWEEPING	COOK	10	1
		ILLINOIS	CONTRACT NO. 02W17	

90/94, 290, 55

DEPARTMENT OF TRANSPORTATION

PROPOSED HIGHWAY PLANS

FOR INDEX OF SHEETS, SEE SHEET NO. 2

ROUTES: VARIOUS SECTION 2023 VAR SWEEPING EXPRESSWAY DAYTIME SWEEPING COOK COUNTY

C-91-111-24

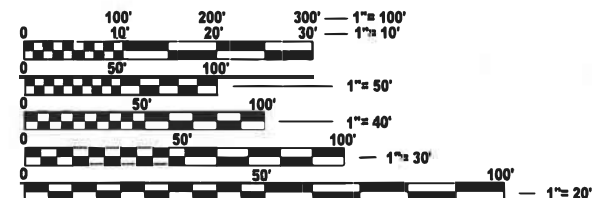

FULL SIZE PLANS HAVE BEEN PREPARED USING STANDARD ENGINEERING SCALES. REDUCED SIZED PLANS WILL NOT CONFORM TO STANDARD SCALES. IN MAKING MEASUREMENTS ON REDUCED PLANS, THE ABOVE SCALES MAY BE USED.

J.U.L.I.E. JOINT UTILITY LOCATION INFORMATION FOR EXCAVATION 1-800-892-0123 OR 811

LOCATION MAPS - SEE INDEX OF SHEETS

PROJECT ENGINEER: RODRIGO LEDEZMA PROJECT MANAGER: J. ALAIN MIDY

(847) 705-4580 (847) 221-3056

CONTRACT NO. 62W17

STATE OF ILLINOIS DEPARTMENT OF TRANSPORTATION

SUBMITTED NOVEMBER 22ND 23

Jose Rio Lopez REGIONAL ENGINEER

February 2, 2024 [Signature] ENGINEER OF DESIGN AND ENVIRONMENT

February 2, 2024 [Signature] DIRECTOR OF HIGHWAYS PROJECT IMPLEMENTATION

PRINTED BY THE AUTHORITY OF THE STATE OF ILLINOIS

INDEX OF SHEETS

SHEET NO.	DESCRIPTION
1	TITLE SHEET
2	INDEX OF SHEETS, APPLICABLE STATE STANDARDS
3	SUMMARY OF QUANTITIES, SCHEDULE OF CLEANING STARTING DATES
4	EXPRESSWAY TYPICAL SECTIONS
5	TYPICAL ROADWAY CLEANING DETAILS
6	EXPRESSWAY CLEANING: I-90/94 (KENNEDY)
7	EXPRESSWAY CLEANING: I-290 (EISENHOWER), I-90/94 (DAN RYAN)
8	EXPRESSWAY CLEANING: I-55 (STEVENSON)
9	TRAFFIC CONTROL DETAILS FOR FREEWAY SHOULDER CLOSURES AND PARTIAL RAMP CLOSURES (TC-17)
10	SINGLE LANE WEAVE AND MULTI LANE WEAVE (TC-09)

STATE STANDARDS

STANDARD NO.	DESCRIPTION
701400-12	APPROACH TO LANE CLOSURE, FREEWAY / EXPRESSWAY
701401-13	LANE CLOSURE, FREEWAY/EXPRESSWAY
701411-09	LANE CLOSURE, MULTILANE AT ENTERANCE/EXIT RAMP FOR SPEEDS > 45 MPH
701426-09	LANE CLOSURE, MULTILANE, INTERMITTENT OR MOVING OPER., FOR SPEEDS > 45 MPH
701428-01	TRAFFIC CONTROL SETUP AND REMOVAL FREEWAY / EXPRESSWAY
701901-09	TRAFFIC CONTROL DEVICES

MODEL: GenNotesSh01 (Sheet)
 FILE NAME: c:\pw\work\pav\ledezma\mmd0918684D\09724-shh-gennote.dgn

	USER NAME = rodrigo.ledezma	DESIGNED -	REVISED -	STATE OF ILLINOIS DEPARTMENT OF TRANSPORTATION	INDEX OF SHEETS AND STATE STANDARDS	F.A.I RTE.	SECTION	COUNTY	TOTAL SHEETS	SHEET NO.
		DRAWN -	REVISED -			*	2023 VAR SWEEPING	COOK	10	2
	PLOT SCALE = 0.16666633' / in.	CHECKED -	REVISED -							
	PLOT DATE = 1/9/2024	DATE -	REVISED -		SCALE:					
					SHEET	OF 2	SHEETS	STA.		TO STA.
								ILLINOIS		FED. AID PROJECT

SUMMARY OF QUANTITIES

CODE NO.	ITEM	UNIT	URBAN	100 % STATE 0044
			TOTAL QUANTITIES	EXPRESSWAY
Z0010617	SUPPLEMENTAL SWEEPING	MILE	294	294
X0329915	FULL EXPRESSWAY CLEANING CYCLE	EACH	3	3

NOTES:

1. SCHEDULE MAY VARY AS DIRECTED BY THE ENGINEER.
2. THE CONTRACTOR MAY NOT START CLEANING CYCLES BEFORE THE DATES SCHEDULED IN THE PLANS WITHOUT WRITTEN AUTHORIZATION FROM THE ENGINEER.
3. NO WORK WILL BE ALLOWED DURING ANY LEGAL HOLIDAY PERIOD.
4. NO DAILY CONTRACTOR WORK REQUESTS / SCHEDULING SHALL BE AUTHORIZED OR APPROVED TO START WHEN IT IS DETERMINED BY THE ENGINEER THAT WEATHER CONDITIONS WILL BE UNFAVORABLE. APPROVAL OF ALL DAILY CONTRACTOR WORK SCHEDULE REQUEST SHALL BE SOLELY DETERMINED BY THE ENGINEER AND/OR PROJECT SUPERVISOR.
5. ALL LANE AND SHOULDER CLOSURES SHALL BE IMMEDIATELY REMOVED DURING ALL ADVERSE WEATHER CONDITIONS WITHOUT EXCEPTION, INCLUDING BUT NOT LIMITED TO RAIN, WET ROAD SURFACE (SPRAY FROM TIRES), MIST, DRIZZLE, SLEET, SNOW, FOG AND ANY OTHER CIRCUMSTANCE DETERMINED UNSAFE BY THE ENGINEER. THE CONTRACTOR SHALL IMPLEMENT THIS CONTRACT REQUIREMENT IMMEDIATELY WITHOUT WAITING FOR DEPARTMENT INSTRUCTIONS.
6. SWEEPING WILL NOT BE ALLOWED WHEN TEMPERATURES OR WIND CHILL FACTORS ARE FORECASTED BY THE DEPARTMENTS CERTIFIED CONSULTING METEOROLOGISTS TO BE AT OR DROP BELOW FREEZING. TEMPERATURE MUST BE ABOVE THIRTY-TWO (32) DEGREES FAHRENHEIT. ALL SHOULDER AND CURB LINES MUST BE FREE OF ANY EXISTING SNOW AND/OR ICE. DRY SWEEPING SHALL BE ALLOWED ONLY IF IT IS CONSIDERED AN EMERGENCY, IMMEDIATE HAZARD, OR ANY WORK AS DESIGNATED BY THE DEPARTMENT THAT REQUIRES FIRST PRIORITY CORRECTIVE ACTION.
7. EXPRESSWAY CLEANING CYCLE SCHEDULE WILL BE COORDINATED DURING THE PRE-CONSTRUCTION MEETING.
8. NO WORK WILL BE ALLOWED DAY OR NIGHT ON THE FOLLOWING DATES UNLESS IT IS CONSIDERED AN EMERGENCY, IMMEDIATE HAZARD OR ANY WORK AS DESIGNATED BY THE DEPARTMENT THAT REQUIRES FIRST PRIORITY CORRECTIVE ACTION:

2024: MARCH 29 - APRIL 1	EASTER HOLIDAY
MAY 24 - 28	MEMORIAL DAY HOLIDAY
JULY 3 - 8	INDEPENDENCE DAY HOLIDAY
NOVEMBER 27 - DECEMBER 2	THANKSGIVING HOLIDAY
DECEMBER 22 - JANUARY 1/2025	CHRISTMAS / NEW YEAR'S HOLIDAY

MODEL: GenNotesSh02 [Sheet]
 FILE NAME: c:\p\work\pav\01\ledezma\m\0918584\ID109724-sh-gennote.dgn

USER NAME = rodrigo.ledezma PLOT SCALE = 0.16666833' / in. PLOT DATE = 10/31/2023	DESIGNED - DRAWN - CHECKED - DATE -	REVISED - REVISED - REVISED - REVISED -	STATE OF ILLINOIS DEPARTMENT OF TRANSPORTATION	SUMMARY OF QUANTITIES & SCHEDULE OF STARTING DATES	F.A.I RTE. *	SECTION 2023 VAR SWEEPING	COUNTY COOK	TOTAL SHEETS 10	SHEET NO. 3	
SCALE:				SHEET OF 2 SHEETS	STA.	TO STA.				
						ILLINOIS	FED. AID PROJECT			

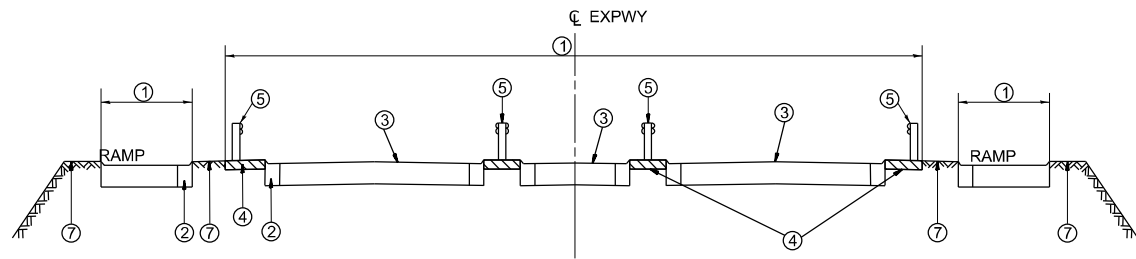

TYPICAL EXPRESSWAY CROSS-SECTION NO. 1

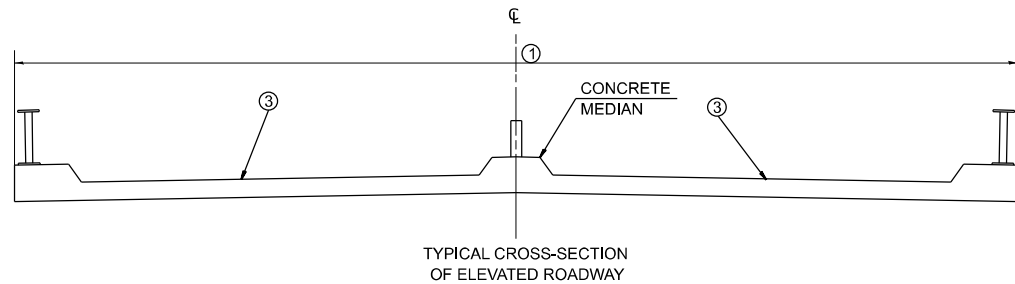

TYPICAL EXPRESSWAY CROSS-SECTION NO. 2

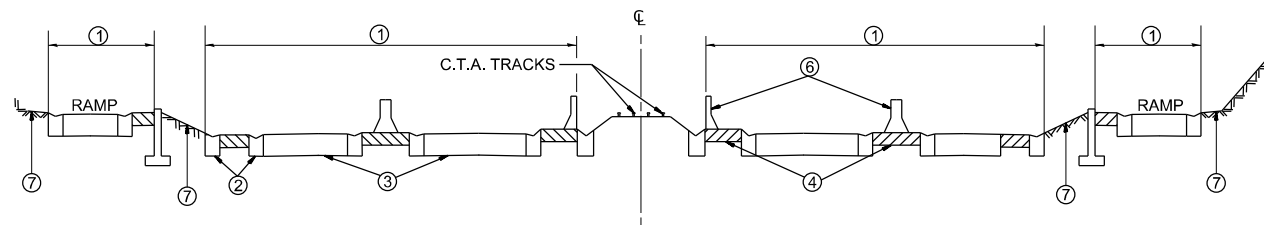

TYPICAL EXPRESSWAY CROSS-SECTION NO. 3

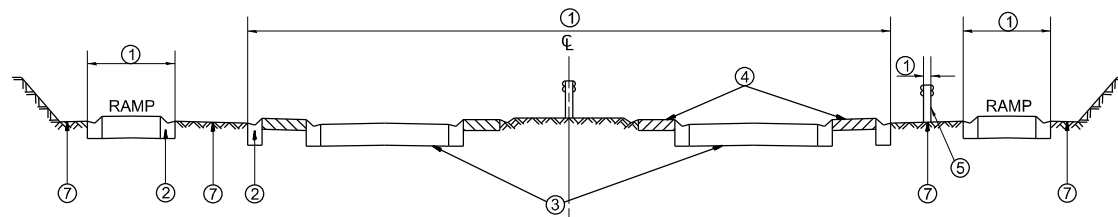

TYPICAL EXPRESSWAY CROSS-SECTION NO. 4

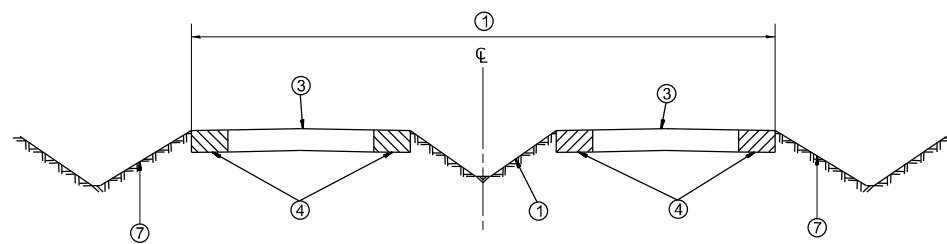

TYPICAL EXPRESSWAY CROSS-SECTION NO. 5

LEGEND

- ① AREA OF ROADWAY CLEANING, DEBRIS AND RUBBISH REMOVAL
- ② CURB AND GUTTER
- ③ TRAVELED ROADWAY
- ④ STABILIZED SHOULDER OR MEDIAN OR SIDEWALK OR NON STABILIZED SURFACES
- ⑤ STEEL PLATE GUARD RAIL (SEE NOTE A)
- ⑥ CONCRETE BARRIER
- ⑦ NON STABILIZED SURFACE
- ⑧ RAISED CONCRETE MEDIAN

NOTE:

- A) ALL MATERIAL/DEBRIS REGARDLESS OF THE THICKNESS AND SIZE SHALL BE REMOVED AND PROPERLY DISPOSED FROM THE STABILIZED SURFACE.
- B) ALL DRAINAGE STRUCTURES MUST BE CLEARED OF DEBRIS WITHIN THE MEDIAN.

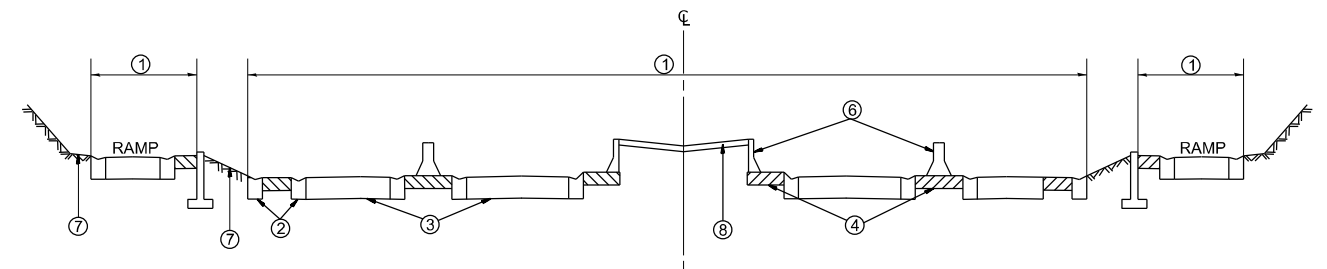

TYPICAL EXPRESSWAY CROSS-SECTION NO. 6

MODEL: TYP (Sheet)
FILE NAME: c:\p\work\project\ledezma\m0918584\109724-sh-typical.dgn

USER NAME = rodrigo.ledezma	DESIGNED -	REVISED -
PLOT SCALE = 0.16666833' / in.	DRAWN -	REVISED -
PLOT DATE = 9/6/2023	CHECKED -	REVISED -
	DATE -	REVISED -

**STATE OF ILLINOIS
DEPARTMENT OF TRANSPORTATION**

TYPICAL EXPRESSWAY CROSS SECTIONS

SCALE: 1"=50' SHEET OF 2 SHEETS STA. TO STA.

F.A.I. RTE.	SECTION	COUNTY	TOTAL SHEETS	SHEET NO.
*	2023 VAR SWEEPING	COOK	10	4
CONTRACT NO. 62W17				
ILLINOIS FED. AID PROJECT				

LEGEND

- ① AREA OF ROADWAY CLEANING, DEBRIS AND RUBBISH REMOVAL
- ② CURB AND GUTTER
- ③ TRAVELED ROADWAY
- ④ STABILIZED SHOULDER OR MEDIAN OR SIDEWALK OR NON STABILIZED SURFACES
- ⑤ STEEL PLATE GUARD RAIL (SEE NOTE A)
- ⑥ CONCRETE BARRIER
- ⑦ NON STABILIZED SURFACE
- ⑧ RAISED CONCRETE MEDIAN

NOTE:

- A) ALL MATERIAL/DEBRIS REGARDLESS OF THE THICKNESS AND SIZE SHALL BE REMOVED AND PROPERLY DISPOSED FROM THE STABILIZED SURFACE.
- B) ALL DRAINAGE STRUCTURES MUST BE CLEARED OF DEBRIS WITHIN THE MEDIAN.

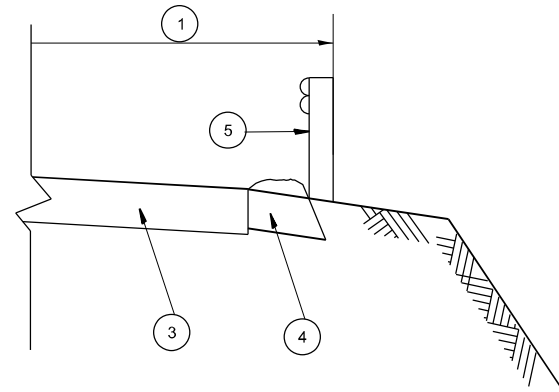

GUARDRAIL LABOR DETAIL

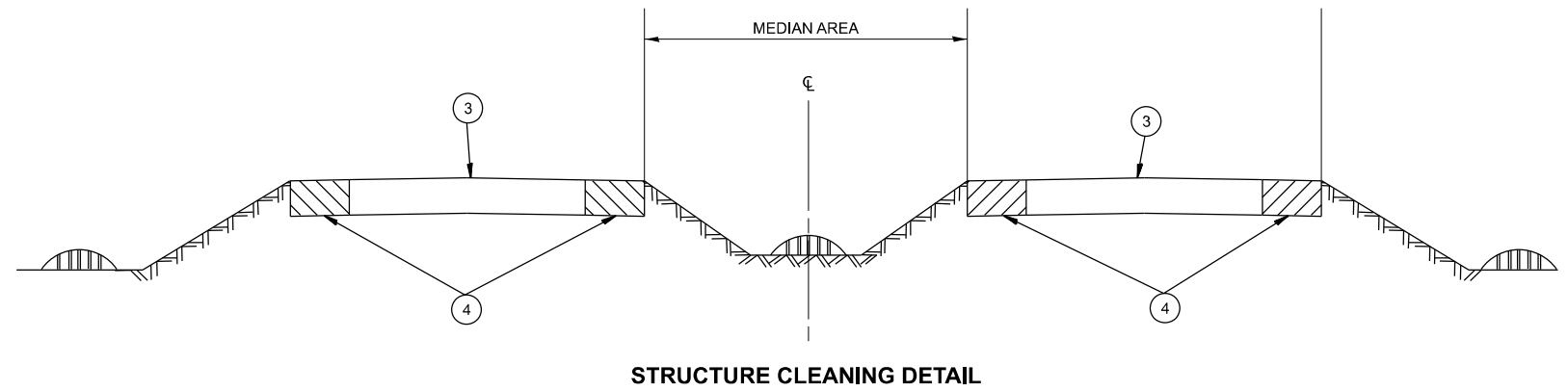
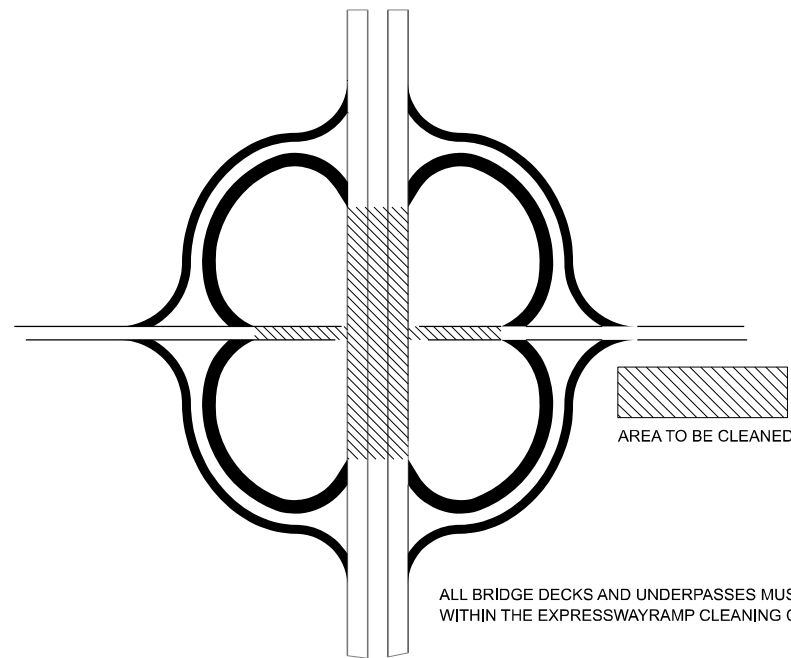

STRUCTURE CLEANING DETAIL

MODEL: TYP-1 | Sheet1
FILE NAME: c:\p\work\p\work\ledezma\m\0918584\109724-sh-typical.dgn

USER NAME = rodrigo.ledezma	DESIGNED -	REVISED -
PLOT SCALE = 0.16666633' / in.	DRAWN -	REVISED -
PLOT DATE = 9/6/2023	CHECKED -	REVISED -
	DATE -	REVISED -

**STATE OF ILLINOIS
DEPARTMENT OF TRANSPORTATION**

TYPICAL EXPRESSWAY CROSS SECTIONS

SCALE: 1"=50' SHEET OF 2 SHEETS STA. TO STA.

F.A.I RTE.	SECTION	COUNTY	TOTAL SHEETS	SHEET NO.
*	2023 VAR SWEEPING	COOK	10	5
CONTRACT NO. 62W17				
ILLINOIS FED. AID PROJECT				



DAY CLEANING ONLY

I-290 Extension
 I-290 from Illinois 83 to Interstate 90 Jane Addams Tollway, Illinois 53 from Interstate 90 Jane Addams Tollway to Lake Cook Road including I-355 from I-290 to Army Trail Road.

Edens Expressway
 Interstate 94 from Montrose to Dundee Road and U.S. 41 from Dundee Road to 700 lineal feet north of Illinois 137 including two ramps at Clavey Road, two ramps at West Park Avenue, four ramps at Deerpath Road and the entire US 41/Deerfield Road interchange. Also included is Tower Road from Edens Expressway to Forestway Drive.

Kennedy Expressway
 All ramps on Interstate 90/94 from Ogden Ave. to Interstate 90/94 Junction at Edens Expressway, Interstate 90 from Interstate 90/94 Junction at Edens Expressway to Interstate 90/190 Junction, and Interstate 190 from Interstate 90/190 Junction to the East Limits of O'Hare International Airport (Bessie Coleman Rd.) unless ramps are too narrow to allow traffic to pass sweeping crew.

ACCIDENT INVESTIGATION SITES:

- 1 INBOUND INTERSTATE 90/94 AT ADDISON STREET OFF RAMP.
- 2 INBOUND INTERSTATE 90/94 ALONG FULLERTON AVENUE UNDER INTERSTATE 90/94.
- 3 INBOUND INTERSTATE 90/94 IN THE OHIO STREET INFIELD.
- 4 INTERSTATE 90/94 AT POLK AVENUE.
- 5 OUTBOUND INTERSTATE 90/94 ALONG DIVISION STREET OFF RAMP.
- 6 OUTBOUND INTERSTATE 90/94 ALONG INTERSTATE 90/94 AT DAMEN AVENUE.
- 7 OUTBOUND INTERSTATE 90/94 ALONG FULLERTON AVENUE UNDER INTERSTATE 90/94.
- 8 OUTBOUND INTERSTATE 90/94 ALONG KIMBALL STREET OFF RAMP.
- 9 OUTBOUND INTERSTATE 94 ALONG FOSTER AVENUE OFF RAMP.
- 10 OUTBOUND INTERSTATE 90/94 JUST BEFORE LAWRENCE AVENUE OFF RAMP.

DISTRICT NO. 1

- STATE HIGHWAYS & EXPRESSWAYS WITHIN STATE JURISDICTION (EXCEPT TOLLWAYS)
- STATE HIGHWAYS & EXPRESSWAYS TO BE CLEANED
- FUTURE HIGHWAYS
- VARIOUS AGENCIES HIGHWAYS

MODEL: NorthDetail01 (Sheet)
 FILE NAME: c:\p\work\wis\cd\ledezma\m0918584d\09724-sh-4details.dgn

USER NAME = rodrigo.ledezma	DESIGNED -	REVISED -
	DRAWN -	REVISED -
PLOT SCALE = 0.16666833 ' / in.	CHECKED -	REVISED -
PLOT DATE = 10/31/2023	DATE -	REVISED -

**STATE OF ILLINOIS
 DEPARTMENT OF TRANSPORTATION**

**EXPRESSWAY CLEANING LOCATION MAP
 I-90/94 (KENNEDY)**

SCALE: SHEET OF 3 SHEETS STA. TO STA.

F.A.I RTE.	SECTION	COUNTY	TOTAL SHEETS	SHEET NO.
*	2023 VAR SWEEPING	COOK	10	6
			CONTRACT NO. 62W17	

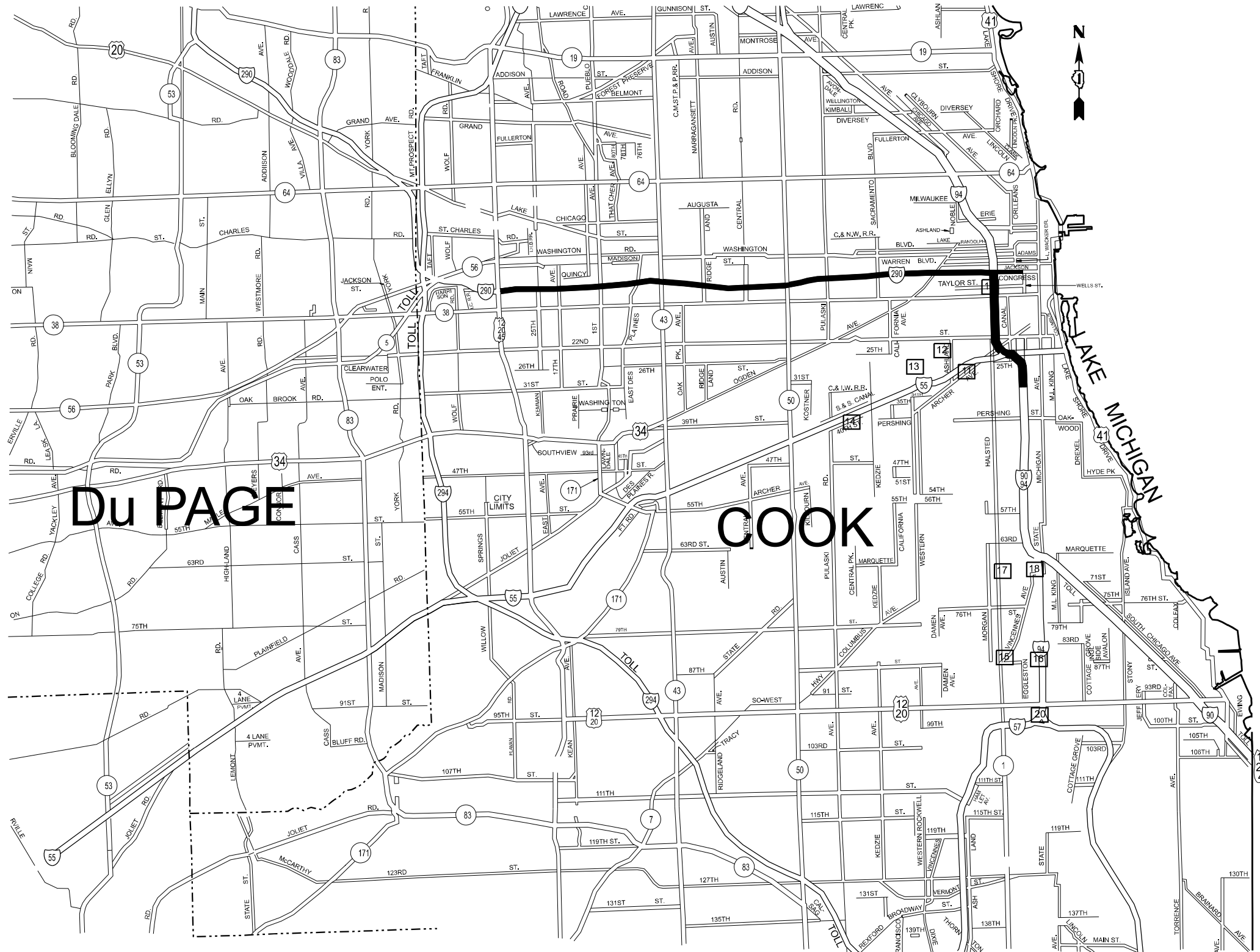

Du PAGE

COOK

DAY CLEANING ONLY

Eisenhower Expressway

Interstate 290 and its appurtenances from Wells St. to Austin Blvd. in its entirety, from Austin Blvd. to IL-83 right hand side and all ramps, the eastbound collector-distributor lanes and ramps at the U.S. 12/20/45 (Mannheim Rd.) interchange and westbound to Roosevelt Rd. on its extension.

Stevenson Expressway

Interstate 55 (Stevenson Expressway) from Lake Shore Drive to the Cook-DuPage county line (County Line Rd.), including First Avenue, from 43rd Street to Archer Avenue, the ramps to and from Joliet Rd. from Interstate 55 to Wolf Rd, the ramps from northbound Interstate 55 to northbound Interstate 294 Tollway and from southbound Interstate 294 Tollway to northbound Interstate 55 (Limits of cleaning on these ramps are from Interstate 55 to the first painted gore south of the bridge over Joliet rd), and all accident investigation sites, excluding the entire Stevenson - Dan Ryan Interchange.

I 55 Expressway

Interstate 55 from Cook - DuPage county line (County Line Rd.) to I-355, I & M Canal to Will - Grundy county line (Reed Rd.) in its entirety, including all ramps and the entire I-55 - I-80 interchange, all accident investigation sites, Blodgett Rd. from Kelly Rd. to West Frontage Rd., Arsenal Rd. from the East Frontage Rd. to Elwood International Port Rd. (Baseline Rd.), and the West Frontage Rd. Connector from Arsenal Rd. to the southbound entrance ramp.

Dan Ryan Expressway

Interstate 94 from Cottage Grove Ave to 31st St right hand side of both local and express lanes and all ramps except slip ramps between local and express lanes and any ramps too narrow to allow traffic to pass sweeping crew.

ACCIDENT INVESTIGATION SITES:

FOR LOCATIONS 1-10, SEE INNER CITY EXPRESSWAY (NORTH SECTION)

- 11 INBOUND INTERSTATE 55 AT HALSTED STREET
- 12 OUTBOUND INTERSTATE 55 AT THROOP STREET
- 13 INBOUND INTERSTATE 55 AT WOOD STREET. (LOCATED UNDER I-55)
- 14 OUTBOUND INTERSTATE 55 AT KEDZIE AVENUE
- 15 INTERSTATE 90/94 AT 87th STREET (NORTHBOUND AND SOUTHBOUND)
- 16 INTERSTATE 90/94 AT 71st STREET (NORTHBOUND AND SOUTHBOUND)
- 17 INTERSTATE 90/94 AT POLK STREET
- 18 INTERSTATE 90/94 AT KING DRIVE
- 19 INTERSTATE 90/94 AT KING DRIVE
- 20 INTERSTATE 90/94 AT KING DRIVE

DISTRICT NO. 1

- STATE HIGHWAYS & EXPRESSWAYS WITHIN STATE JURISDICTION (EXCEPT TOLLWAYS)
- STATE HIGHWAYS & EXPRESSWAYS TO BE CLEANED
- FUTURE HIGHWAYS
- VARIOUS AGENCIES HIGHWAYS

MODEL: NorthDetail02 (Sheet)
FILE NAME: c:\p\work\pav\cld\des\marm\0918584D109724-sh-detailed.dgn

USER NAME = rodrigo.ledezma	DESIGNED -	REVISED -
	DRAWN -	REVISED -
PLOT SCALE = 0.16666833' / in.	CHECKED -	REVISED -
PLOT DATE = 10/31/2023	DATE -	REVISED -

STATE OF ILLINOIS
DEPARTMENT OF TRANSPORTATION

EXPRESSWAY CLEANING LOCATION MAP
I-290 (EISENHOWER) & I-90/94 (DAN RYAN)

SCALE: SHEET OF 3 SHEETS STA. TO STA.

F.A.I RTE.	SECTION	COUNTY	TOTAL SHEETS	SHEET NO.
*	2023 VAR SWEEPING	COOK	10	7
			CONTRACT NO. 62W17	
ILLINOIS FED. AID PROJECT				

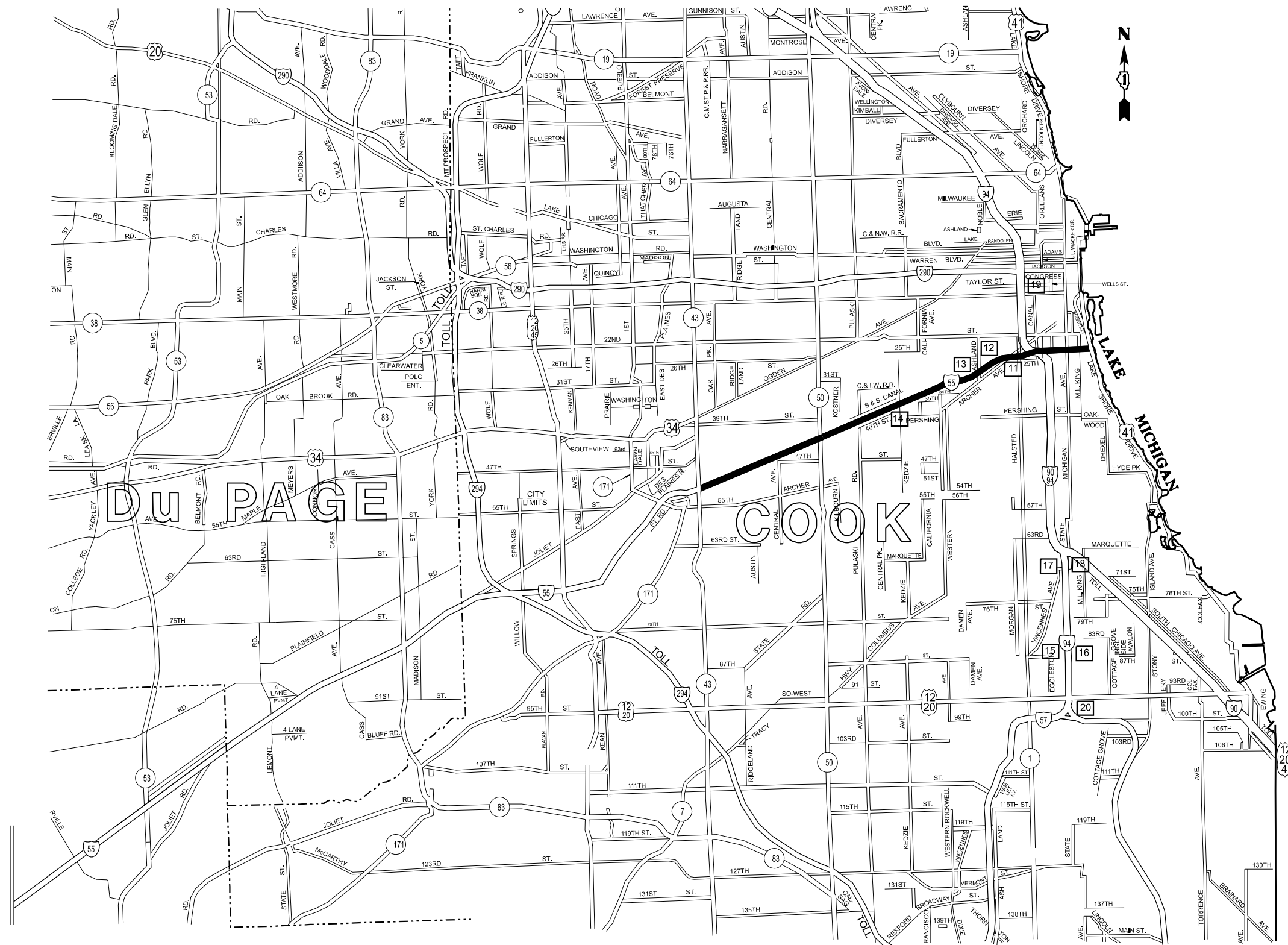

Eisenhower Expressway

Interstate 290 and its appurtenances from Wells St. to Austin Blvd. in its entirety, from Austin Blvd. to IL-83 right hand side and all ramps, the eastbound collector-distributor lanes and ramps at the U.S. 12/20/45 (Mannheim Rd.) interchange and westbound to Roosevelt Rd. on its extension.

Stevenson Expressway

Interstate 55 (Stevenson Expressway) from Lake Shore Drive to the Cook-DuPage county line (County Line Rd.), including First Avenue, from 43rd Street to Archer Avenue, the ramps to and from Joliet Rd. from Interstate 55 to Wolf Rd, the ramps from northbound Interstate 55 to northbound Interstate 294 Tollway and from southbound Interstate 294 Tollway to northbound Interstate 55 (Limits of cleaning on these ramps are from Interstate 55 to the first painted gore south of the bridge over Joliet rd), and all accident investigation sites, excluding the entire Stevenson - Dan Ryan Interchange.

I 55 Expressway

Interstate 55 from Cook - DuPage county line (County Line Rd.) to I-355, I & M Canal to Will - Grundy county line (Reed Rd.) in its entirety, including all ramps and the entire I-55 - I-80 interchange, all accident investigation sites, Blodgett Rd. from Kelly Rd. to West Frontage Rd., Arsenal Rd. from the East Frontage Rd. to Elwood International Port Rd. (Baseline Rd.), and the West Frontage Rd. Connector from Arsenal Rd. to the southbound entrance ramp.

Dan Ryan Expressway

Interstate 94 from Cottage Grove Ave to 31st St right hand side of both local and express lanes and all ramps except slip ramps between local and express lanes and any ramps too narrow to allow traffic to pass sweeping crew.

ACCIDENT INVESTIGATION SITES:

FOR LOCATIONS 1-10, SEE INNER CITY EXPRESSWAY (NORTH SECTION)

- 11 INBOUND INTERSTATE 55 AT HALSTED STREET
- 12 OUTBOUND INTERSTATE 55 AT THROOP STREET
- 13 INBOUND INTERSTATE 55 AT WOOD STREET. (LOCATED UNDER I-55)
- 14 OUTBOUND INTERSTATE 55 AT KEDZIE AVENUE
- 15 INTERSTATE 90/94 AT 87th STREET (NORTHBOUND AND SOUTHBOUND)
- 16 INTERSTATE 90/94 AT 71st STREET (NORTHBOUND AND SOUTHBOUND)
- 17 INTERSTATE 90/94 AT POLK STREET
- 18 INTERSTATE 90/94 AT KING DRIVE

DISTRICT NO. 1

- STATE HIGHWAYS & EXPRESSWAYS WITHIN STATE JURISDICTION (EXCEPT TOLLWAYS)
- STATE HIGHWAYS & EXPRESSWAYS TO BE CLEANED
- FUTURE HIGHWAYS
- VARIOUS AGENCIES HIGHWAYS

MODEL: SouthDetail03 (Sheet)
FILE NAME: c:\p\work\civil\ledezma\m0918584d\09724-sh-details.dgn

USER NAME = rodrigo.ledezma	DESIGNED -	REVISED -
	DRAWN -	REVISED -
PLOT SCALE = 0.16666833' / in.	CHECKED -	REVISED -
PLOT DATE = 10/31/2023	DATE -	REVISED -

**STATE OF ILLINOIS
DEPARTMENT OF TRANSPORTATION**

**EXPRESSWAY CLEANING LOCATION MAP
I-55 (STEVENSON)**

SCALE: SHEET OF 3 SHEETS STA. TO STA.

F.A.I RTE.	SECTION	COUNTY	TOTAL SHEETS	SHEET NO.
*	2023 VAR SWEEPING	COOK	10	8
CONTRACT NO. 62W17				

SINGLE LANE WEAVE

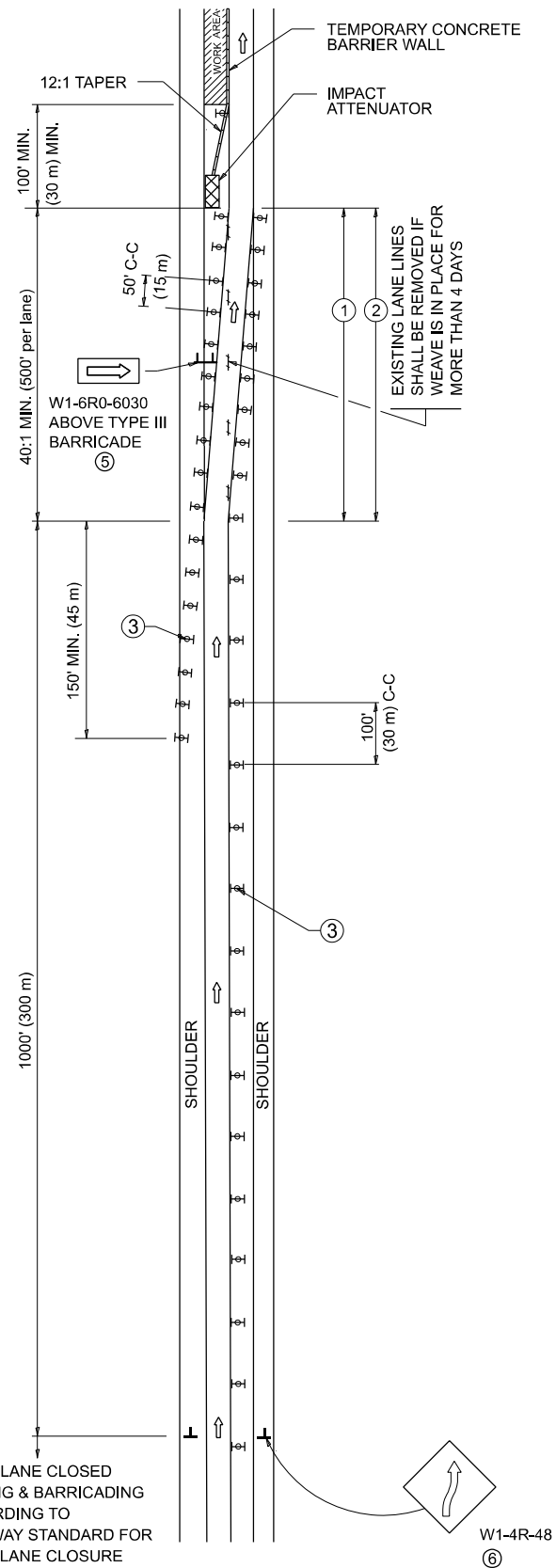

MULTI-LANE WEAVE

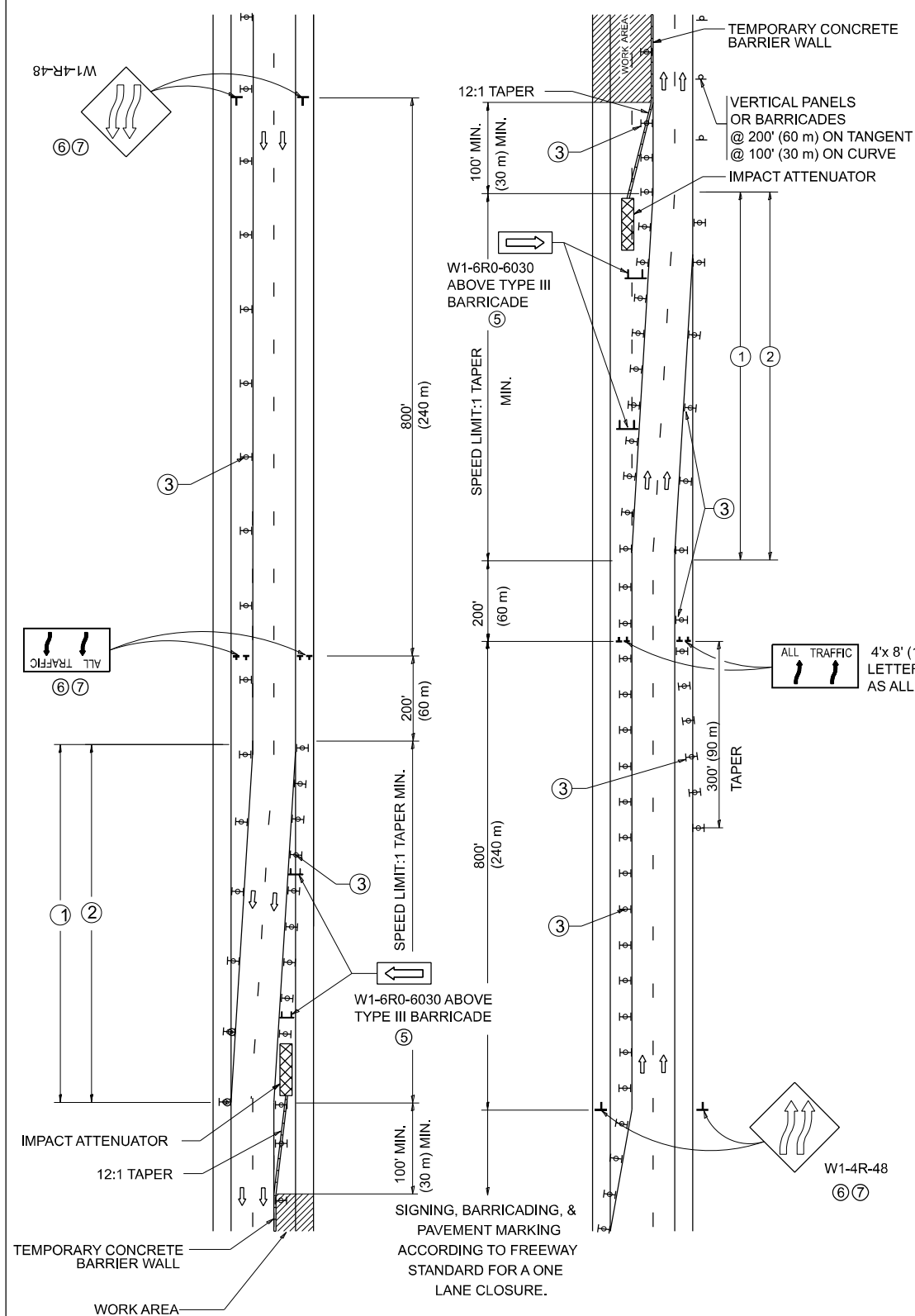

GENERAL NOTES:

- ① EXISTING CONFLICTING PAVEMENT MARKING LINES SHALL BE REMOVED. PAVEMENT MARKING REMOVAL SHALL NOT BE REQUIRED FOR SINGLE LANE WEAVES UNDER 4 DAYS IN DURATION.
- ② CONTINUOUS REFLECTIVE TEMPORARY PAVEMENT MARKING TAPE SHALL BE PLACED THROUGHOUT THE TAPER AND FOR 300' (90 m) ALONG SIDE THE WORK AREA WHERE THE CLOSURE TIME IS GREATER THAN FOURTEEN DAYS, THE LEFT EDGE LINE SHALL BE YELLOW AND THE RIGHT EDGE LINE SHALL BE WHITE, FOR MULTI-LANE WEAVES LANE LINES SHALL BE 5 INCH, 10'-30' (3 m-9 m) SKIP DASH, WHITE.
- ③ PLASTIC DRUMS WITH STEADY BURN LIGHTS AT 50' (15 m) C-C SPACING IN TAPERS AND 100' (30 m) C-C SPACING IN TANGENTS.
- ④ ALL SIGNS SHALL BE POST MOUNTED IF THE CLOSURE TIME EXCEEDS FOUR DAYS.
- ⑤ TYPE III BARRICADES MAY BE OMITTED FOR SINGLE-LANE WEAVES UNDER 24-HOURS IN DURATION. W1-6 SIGNS WILL STILL BE REQUIRED. IF THE WIDTH OF OFFSET IS LESS THAN 6' THEN THE TYPE III BARRICADE WITH ATTACHED ARROW SIGN PANEL CAN BE ELIMINATED IN THE TAPER AREAS.
- ⑥ WHEN THE LENGTH OF THE SHIFTED SEGMENT (DISTANCE BETWEEN WEAVE POINTS) IS LESS THAN 1500', DOUBLE REVERSE CURVE SIGNS (W24-1) SHOULD BE USED INSTEAD OF THE REVERSE CURVE (W1-4) SIGNS. ARROWS ON THE 4'X8' "ALL TRAFFIC" SIGNS SHALL BE THE SAME SHAPE.
- ⑦ THE NUMBER OF ARROWS ON THESE SIGNS SHALL MATCH THE NUMBER OF LANES OPEN TO TRAFFIC.

SYMBOLS

- DIRECTION OF TRAFFIC
- WORK AREA
- SIGN ON PORTABLE OR PERMANENT SUPPORT
- TYPE II BARRICADE OR DRUM WITH MONO-DIRECTIONAL STEADY BURNING LIGHT
- TEMPORARY CONCRETE BARRIER WALL
- IMPACT ATTENUATOR
- W1-4R-48
- W24-1-48

ALL DIMENSIONS ARE IN INCHES (MILLIMETERS) UNLESS OTHERWISE SHOWN

MODEL: TC-09 (Sheet)
FILE NAME: c:\p\work\project\ledezma\m1d0918584d109724-shh-Distatus.dgn

USER NAME = rodrigo.ledezma	DESIGNED - D.W.S.	REVISED - J.A.F. 02-06
PLOT SCALE = 0.16666633' / in.	CHECKED -	REVISED - S.P.B. 01-07
PLOT DATE = 1/9/2024	DATE - 02-87	REVISED - S.P.B. 12-09
		REVISED - M.D. 06-13

STATE OF ILLINOIS
DEPARTMENT OF TRANSPORTATION

TRAFFIC CONTROL DETAILS FOR
FREEWAY SINGLE & MULTI-LANE WEAVE

SCALE: NONE SHEET 1 OF 2 SHEETS STA. TO STA.

F.A.I. RTE.	SECTION	COUNTY	TOTAL SHEETS	SHEET NO.
*	2023 VAR SWEEPING	COOK	10	10
TC-09		CONTRACT NO. 62W17		
ILLINOIS FED. AID PROJECT				