

\_\_\_ Sq. M. each  
 8.25 Sq. Ft. each  
 \_\_\_ 2 Required  
 Design Series D

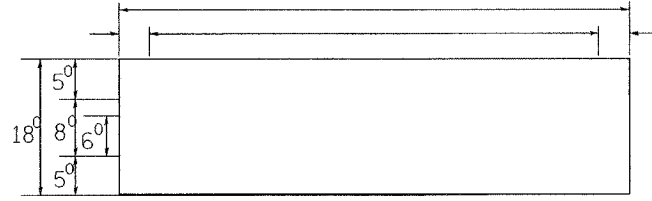

\_\_\_ Sq. M. each  
 9.0 Sq. Ft. each  
 \_\_\_ 2 Required  
 Design Series C

NOTE: SIGN DIMENSIONS ARE IN ENGLISH UNITS

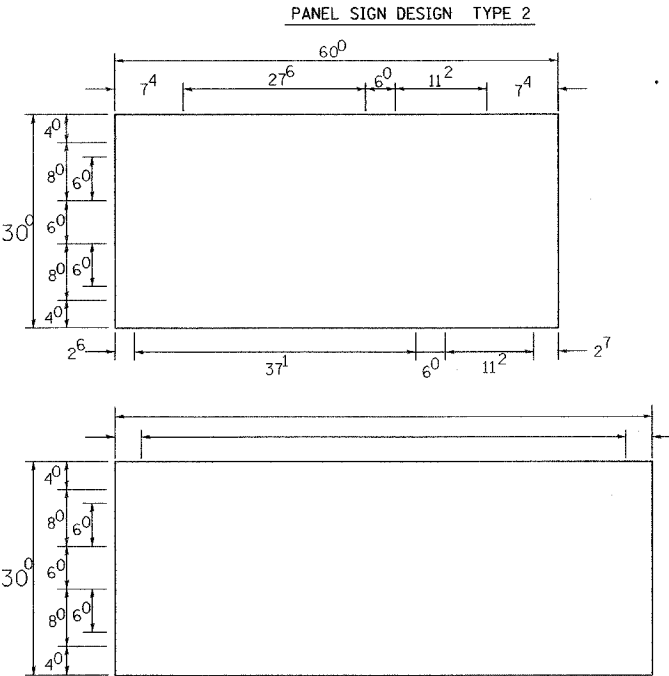

\_\_\_ Sq. M. each  
 \_\_\_ Sq. Ft. each  
 \_\_\_ Required  
 Design Series \_\_\_

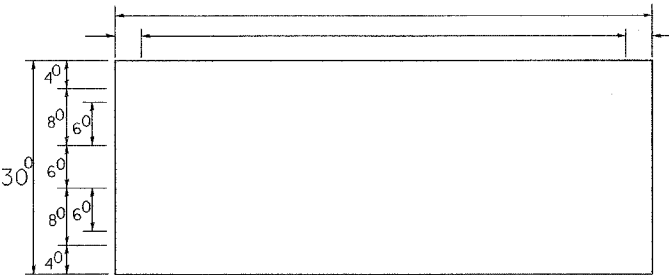

\_\_\_ Sq. M. each  
 \_\_\_ Sq. Ft. each  
 \_\_\_ Required  
 Design Series \_\_\_

GENERAL NOTES

- WHERE MAST ARM MOUNTED STREET NAME SIGNS ARE SPECIFIED, THE MAST ARM ASSEMBLY AND POLES SHALL BE DESIGNED TO SUPPORT THE LOADINGS CALLED FOR ON STANDARDS 834001, 834006 AND 834011, AS APPLICABLE, PLUS TWO (2) SIGN PANELS 2'-6" x 6'-0" MOUNTED AS SHOWN. THE DESIGN SHALL BE IN ACCORDANCE WITH THE REQUIREMENTS OF THE CURRENT "STANDARD SPECIFICATIONS FOR STRUCTURAL SUPPORTS FOR HIGHWAY SIGNS, LUMINAIRES, AND TRAFFIC SIGNALS" AS PUBLISHED BY THE AMERICAN ASSOCIATION OF STATE HIGHWAY AND TRANSPORTATION OFFICIALS FOR 80 M.P.H. WIND VELOCITY.
- ALL SIGNS SHALL HAVE A WHITE REFLECTORIZED LEGEND AND BORDER ON A GREEN REFLECTORIZED BACKGROUND, TYPE A SHEETING.
- THE SIGN LENGTH SHOULD BE INCREASED IN 6-INCH INCREMENTS, BUT THE OVERALL LENGTH SHOULD NOT EXCEED 6'-0".
- ALL BORDERS SHALL BE 3/4" WIDE AND CORNER RADIUS SHALL BE 2-1/4".
- SIGNFIX ALUMINUM CHANNEL FRAMING SYSTEM SHALL BE USED FOR ALL SIGNS ATTACHED TO SIGNAL POLES AND POSTS. LOCAL SUPPLIERS OF THE SIGNFIX ALUMINUM CHANNEL FRAMING SYSTEM ARE:
  - \* A.K.T. CORPORATION, SCHAUMBURG, IL
  - \* AMERICAN FABRICATION CO., CHICAGO HEIGHTS, IL
  - \* TUCKER COMPANY, INC., WAUWATOSA, WI
  - \* WESTERN TRAFFIC CONTROL INC., CICERO, IL

- PARTS LISTING:
- SIGN CHANNEL: PART #HPN053 (MED. CHANNEL)
  - SIGN SCREWS: 1/4" x 14 x 1" H.W.H. #3
  - BRACKETS: SELF TAPPING WITH NEOPRENE WASHER
  - CHANNEL CLAMPS WITH STAINLESS STEEL STRAPPING: PART #HPN034 (UNIVERSAL)
- OTHER BRANDS OF MOUNTING HARDWARE ARE ACCEPTABLE, BASED UPON THE DEPARTMENT'S APPROVAL AND COMPATIBILITY WITH THE CHANNEL/BACKET OF THE ABOVE PRODUCT.

SUPPORTING CHANNELS

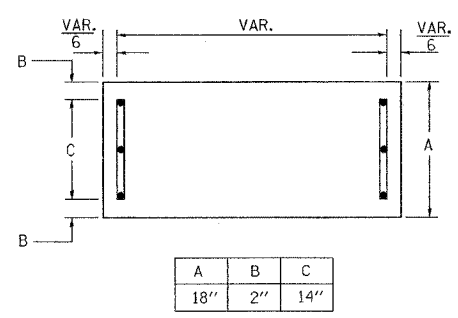

SINGLE ARM

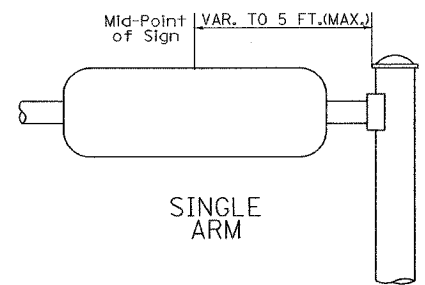

SUPPORTING CHANNELS

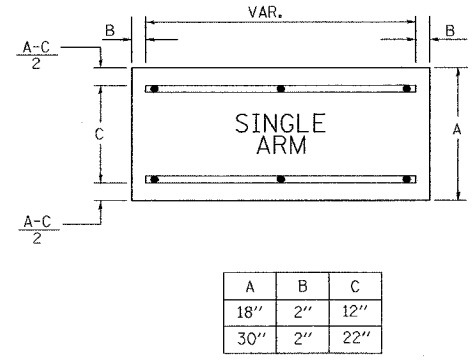

SINGLE ARM

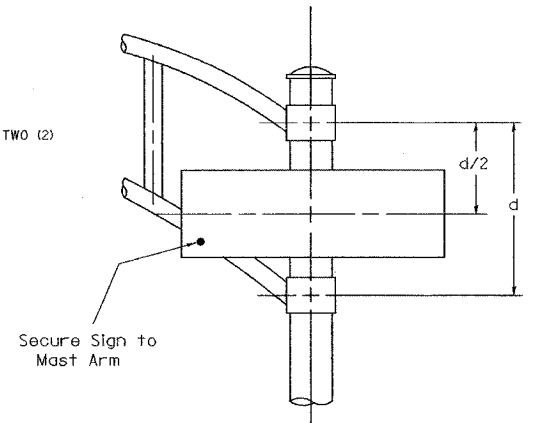

DUAL ARM

SIGNFIX ALUMINUM CHANNEL FRAMING SYSTEM Shall be used. See Note #5.

Upper Case To Lower Case Spacing Chart 8-6 Inch Series "C & D"

EXAMPLE, 2 DENOTES 3/8"

FIRST LETTER	SECOND LETTER															
	acde		bhikl		fw		J		st		vy		x z			
	g	o	q		m	n	p	r								
SERIES	C	D	C	D	C	D	C	D	C	D	C	D	C	D		
A W X	12	14	14	15	12	14	06	10	11	14	06	10	11	12	12	14
B	14	15	20	21	14	15	11	12	14	15	12	14	12	14	16	17
C E G	14	15	20	21	12	14	06	10	12	14	12	14	14	15	14	15
D O Q R	14	15	20	21	14	15	06	10	12	14	12	14	14	15	14	15
F	05	06	14	15	06	10	05	06	06	10	06	10	06	10	11	12
H I M N	20	21	22	24	20	21	14	15	16	17	16	17	20	21	20	21
J U	20	21	20	21	16	17	14	15	16	17	16	17	16	17	20	21
K L	11	12	16	17	11	12	05	06	11	12	11	12	11	12	12	14
P	12	14	14	15	12	14	05	06	11	12	11	12	12	14	12	14
S	12	14	16	17	12	14	06	10	12	14	12	14	12	14	12	14
T	11	12	16	17	06	10	06	10	11	12	11	12	11	12	12	14
V	06	10	14	15	11	12	06	10	12	14	12	14	12	14	12	14
Y	05	06	14	15	06	10	05	06	05	07	05	06	06	10	11	12
Z	16	17	22	24	16	17	12	14	16	17	16	17	16	17	20	21

Lower Case To Lower Case Spacing Chart 6 Inch Series "C & D"

FIRST LETTER	SECOND LETTER															
	acde		bhikl		fw		J		st		vy		x z			
	g	o	q		m	n	p	r								
SERIES	C	D	C	D	C	D	C	D	C	D	C	D	C	D		
adhgi	16	17	22	24	16	17	12	14	14	15	14	15	16	17	16	17
lmnqu																
bkops	12	14	16	17	11	12	05	06	11	12	11	12	12	14	12	14
ce	12	14	16	17	12	14	06	10	12	14	12	14	12	14	12	14
r	06	10	12	14	06	10	03	03	05	06	05	06	06	10	06	10
tz	12	14	16	17	12	14	06	10	11	12	11	12	12	14	12	14
vy	11	12	14	15	11	12	05	06	06	10	06	10	11	12	11	12
w	11	12	14	15	11	12	05	06	11	12	11	12	11	12	12	14
x	12	14	16	17	11	12	05	06	11	12	11	12	11	12	12	14

Number To Number Spacing Chart 8 Inch Series "C & D"

FIRST NUMBER	SECOND NUMBER																			
	0		1		2		3		4		5		6		7		8		9	
	C	D	C	D	C	D	C	D	C	D	C	D	C	D	C	D	C	D	C	D
0 9	16	17	16	17	14	15	12	14	14	15	14	15	16	17	12	14	16	17	16	17
1	20	21	20	21	20	21	16	17	14	15	20	21	20	21	14	15	20	21	20	21
2 3 4	14	15	14	15	14	15	12	14	12	14	14	15	14	15	11	12	16	17	14	15
5	14	15	14	15	14	15	11	12	11	12	14	15	14	15	11	12	14	15	14	15
6	16	17	14	15	14	15	12	14	14	15	14	15	14	15	11	12	14	15	14	15
7	12	14	12	14	14	15	12	14	05	06	12	14	14	15	11	12	14	15	12	14
8	16	17	16	17	14	15	12	14	14	15	16	17	12	14	16	17	14	15	14	15

UPPER AND LOWER CASE LETTER WIDTHS

LETTERS	6 INCH UPPER CASE LETTERS		8 INCH UPPER CASE LETTERS		LETTERS	6 INCH LOWER CASE LETTERS	
	SERIES		SERIES			SERIES	
	C	D	C	D		C	D
A	36	50	50	65	a	35	42
B	32	40	43	53	b	35	42
C	32	40	43	53	c	35	41
D	32	40	43	53	d	35	42
E	30	35	40	47	e	35	42
F	30	35	40	47	f	23	26
G	32	40	43	53	g	35	42
H	32	40	43	53	h	35	42
I	07	07	11	12	i	11	11
J	30	36	40	50	j	20	22
K	32	41	43	54	k	35	42
L	30	35	40	47	l	11	11
M	37	45	51	61	m	60	70
N	32	40	43	53	n	35	42
O	34	42	45	55	o	36	43
P	32	40	43	53	p	35	42
Q	34	42	45	55	q	35	42
R	32	40	43	53	r	26	32
S	32	40	43	53	s	36	42
T	30	35	40	47	t	27	32
U	32	40	43	53	u	35	42
V	35	44	47	60	v	42	47
W	44	52	60	70	w	55	64
X	34	40	45	53	x	44	51
Y	36	50	50	66	y	46	53
Z	32	40	43	53	z	36	43

NUMBER	6 INCH SERIES		8 INCH SERIES	
	C	D	C	D
1	12	14	15	20
2	32	40	43	53
3	32	40	43	53
4	35	43	47	57
5	32	40	43	53
6	32	40	43	53
7	32	40	43	53
8	32	40	43	53
9	32	40	43	53
0	34	42	45	55

REVISIONS	
NAME	DATE

ILLINOIS DEPARTMENT OF TRANSPORTATION

MAST ARM MOUNTED STREET NAME SIGNS

US ROUTE 20 (LAKE STREET)

SCALE: NONE  
 DATE: 03/01/05

DRAWN BY: RDB  
 DESIGNED BY: JHE  
 CHECKED BY: DAD

FILE: d6v171484\_us20cad1484drt701-1b.rvt