

F.A.P. RTE.	SECTION	COUNTY	TOTAL SHEETS	SHEET NO.
549	116RS-1	OGLE	593	252
STA.		TO STA.		
FED. ROAD DIST. NO.		ILLINOIS FED. AID PROJECT		

ENTRANCE APPROACHES - URBAN AREA

TYPICAL APPLICATION OF ENTRANCES

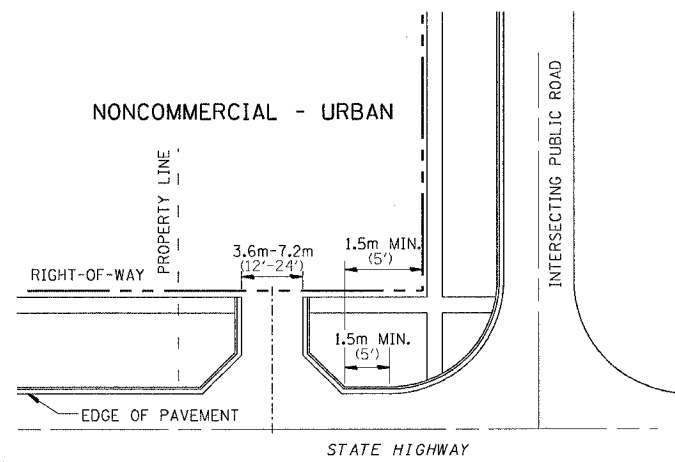
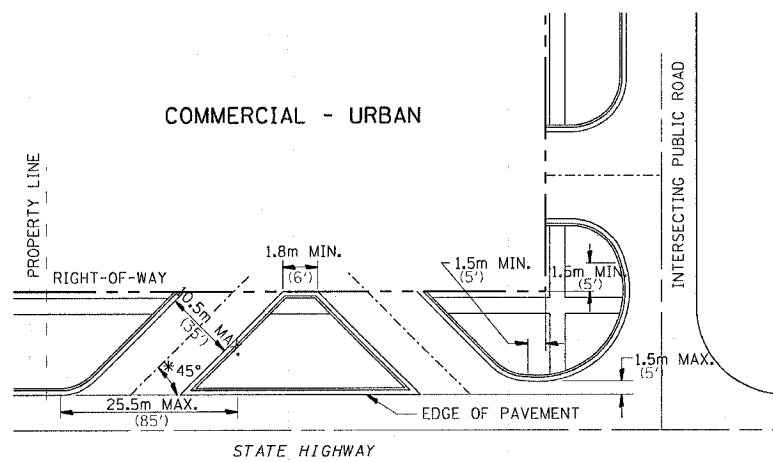

WHEN THE ISLAND BETWEEN DRIVES IS LESS THAN 7.5m (25') LONG OR LESS THAN 10 FEET WIDE, IT SHALL BE DEFINED BY CURBS, MASONRY, OR OTHER DEVICES.
 * 45° MIN. ANGLE PERMITTED ONLY FOR ONE-WAY DRIVEWAYS.
 60° MIN. ANGLE FOR TWO-WAY DRIVEWAYS.

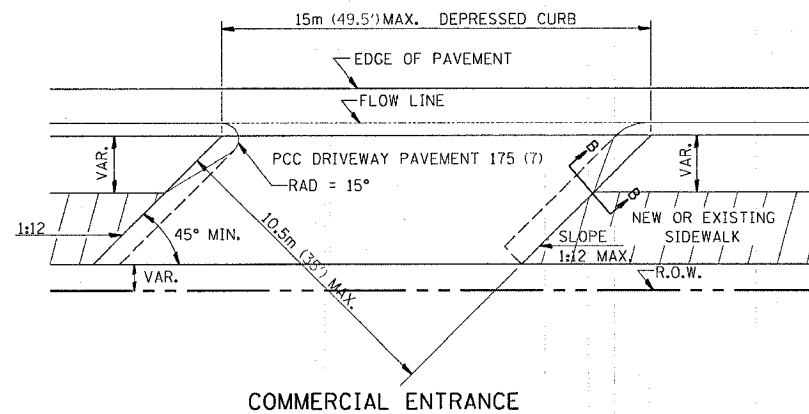

COMMERCIAL ENTRANCE

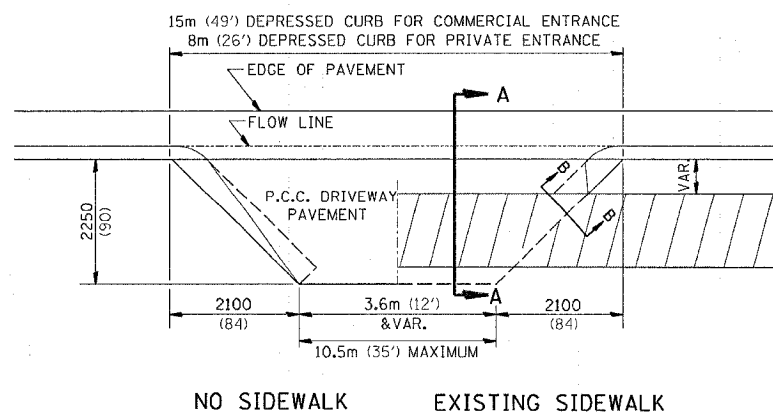

NO SIDEWALK EXISTING SIDEWALK

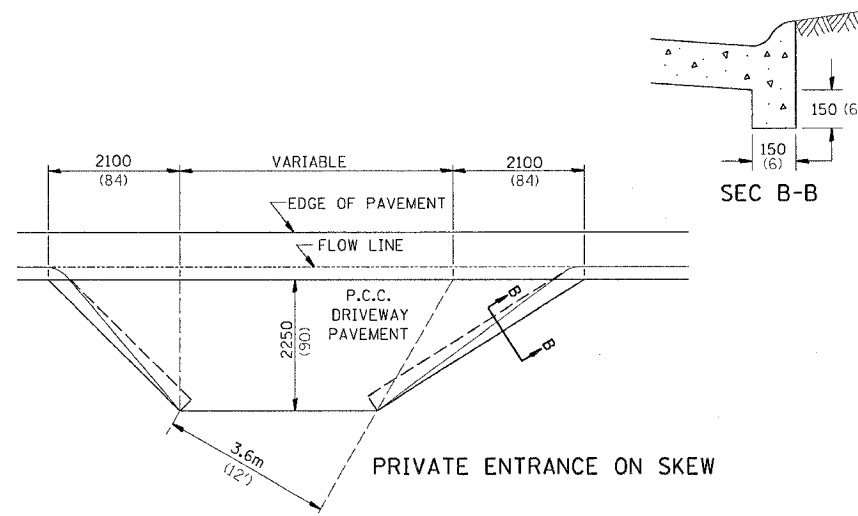

PRIVATE ENTRANCE ON SKEW

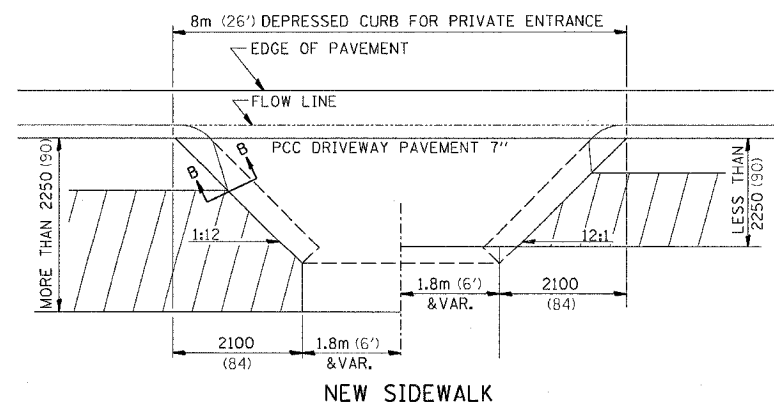

NEW SIDEWALK

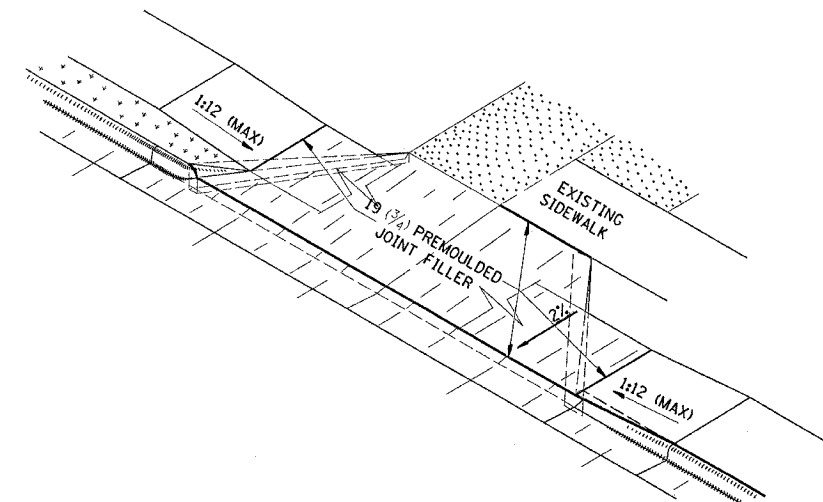

ASCENDING APPROACH

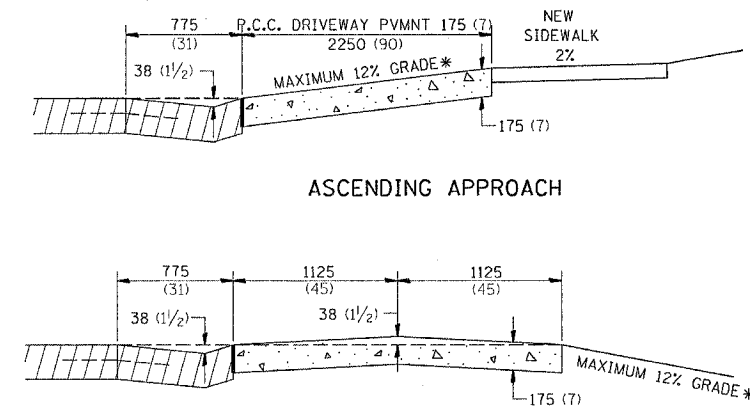

DESCENDING APPROACH

* IN CASES WHERE GRADE EXCEEDS 12%, THE RESIDENT ENGINEER SHALL CHECK WITH DISTRICT DESIGN OFFICE TO DETERMINE NEW APPROACH GRADE. PARTICULAR ATTENTION SHALL BE PAID TO THE NEGATIVE GRADE TO PREVENT DRAINAGE FROM OVER FLOWING INTO THE PRIVATE ENTRANCE.

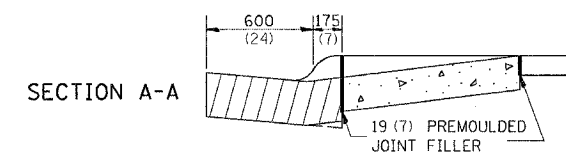

SECTION A-A

THE VARIABLE HEIGHT INTEGRAL CURB AND PREMOULDED JOINT FILLER WILL NOT BE PAID FOR SEPARATELY, BUT SHALL BE INCLUDED IN THE CONTRACT UNIT PRICE OF DRIVEWAY PAVEMENT OF THE THICKNESS SPECIFIED.

ALL DIMENSIONS ARE IN MILLIMETERS (INCHES) UNLESS OTHERWISE NOTED.

DATE-TIME
 CON-SPEC
 REF
 REF
 REF