

TYPE A - CABLE SPLICE

FOR SPLICES IN HOMERUNS AND FOR EXTENSIONS TO EXISTING CABLES ONLY
N.T.S.

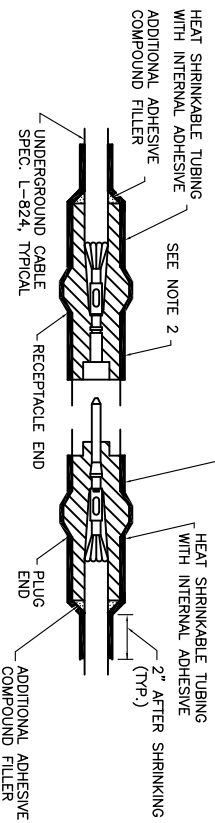

TYPE B - CABLE SPLICE

FOR SPLICES FOR USE AT JUNCTION OF HOMERUN WITH LOOP CIRCUIT
N.T.S.

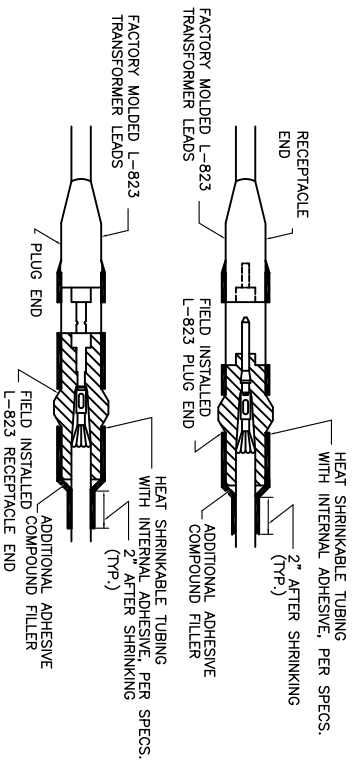

TYPE C AND D - CABLE SPLICE

FOR SPLICES AT RUNWAY/TAXIWAY LIGHTS AND SIGNS
N.T.S.

NOTES

1. INSIDE DIAMETER OF CONNECTOR SHALL PROPERLY MATCH THE OUTSIDE DIAMETER OF CABLE.
2. WRAP WITH AT LEAST ONE LAYER OF RUBBER OR SYNTHETIC RUBBER TAPE AND ONE LAYER OF PLASTIC TAPE, ONE-HALF LAPPED, EXTENDING AT LEAST 1-1/2 INCHES ON EACH SIDE OF JOINT.
3. THE COST OF FURNISHING AND INSTALLING ALL SPLICE MATERIALS SHALL BE INCIDENTAL TO THE ASSOCIATED CABLE ITEMS.
4. THE CONTRACTOR SHALL HAVE A MINIMUM OF TWO (2) TYPE A SPLICE KITS ON THE JOB SITE AT ALL TIMES FOR EMERGENCY REPAIRS.

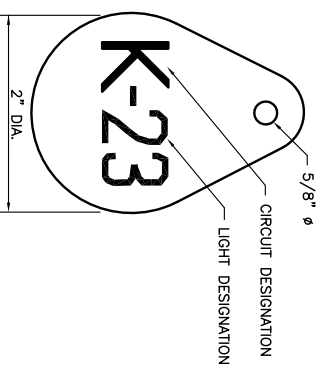

NOTES

1. INSTALL A NONCORROSIVE DISC OF 2" MINIMUM DIAMETER WITH THE NUMBER PERMANENTLY STAMPED, CUT OUT, OR ENGRAVED UNDER THE HEAD OF THE BASE PLATE BOLT OR ATTACHED TO LIGHT FLANGE WITH A SET SCREW.
2. NUMERALS SHOWN ARE FOR ILLUSTRATIVE PURPOSES ONLY. ALL EXISTING AND PROPOSED LIGHTS AND SIGNALS TO BE LOCATED AND SIZED AS SHOWN BY THE RESIDENT ENGINEER. ALL LIGHTS ON EXISTING CIRCUITS THAT HAVE LIGHTING IMPROVEMENTS (PROPOSED OR RELOCATED LIGHTS) SHALL BE RETAGGED.
3. COST OF TAGGING LIGHTS SHALL NOT BE PAID FOR SEPARATELY BUT SHALL BE CONSIDERED INCIDENTAL TO THE CONTRACT.

LIGHT IDENTIFICATION DETAIL

NOT TO SCALE

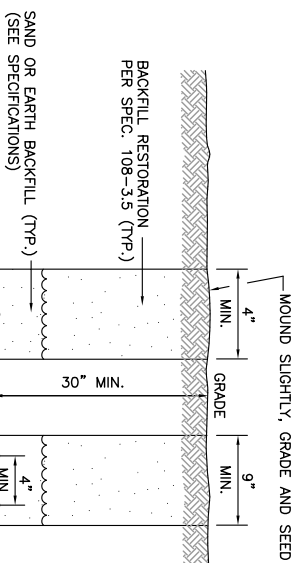

TURF AREA CABLE TRENCH DETAIL

NOT TO SCALE

NOTES

1. TRENCHES WITH MORE THAN 2 CABLES SHALL BE INCREASED 3" IN WIDTH FOR EACH ADDITIONAL CABLE. IF SPECIFIED ON PLANS, TWO PARALLEL TRENCHES MAY BE CONSTRUCTED.
2. DEPTH OF TRENCHES SHALL BE AS SHOWN UNLESS OTHERWISE SPECIFIED ON THE PLANS.
3. SAND BACKFILL SHALL BE USED IF THE EXISTING SOIL DOES NOT MEET THE BACKFILL REQUIREMENTS.
4. ALL DISTURBED SURFACES SHALL BE RESTORED TO THEIR ORIGINAL CONDITION. COST IS INCIDENTAL.

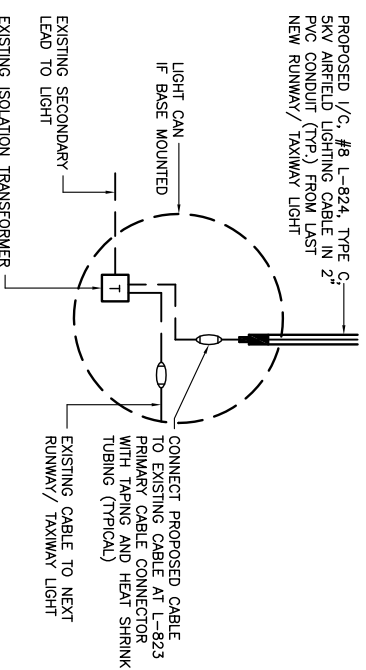

RUNWAY/TAXIWAY LIGHTING CIRCUIT CONNECTION DETAIL

NOT TO SCALE

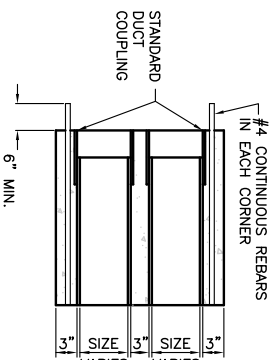

CONCRETE ENCASED DUCT END DETAIL

NO SCALE

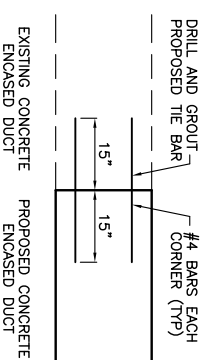

EXTENSION OF EXISTING DUCT

NO SCALE

NOTE: COST OF CONNECTION SHALL BE CONSIDERED INCIDENTAL TO PROPOSED DUCT.

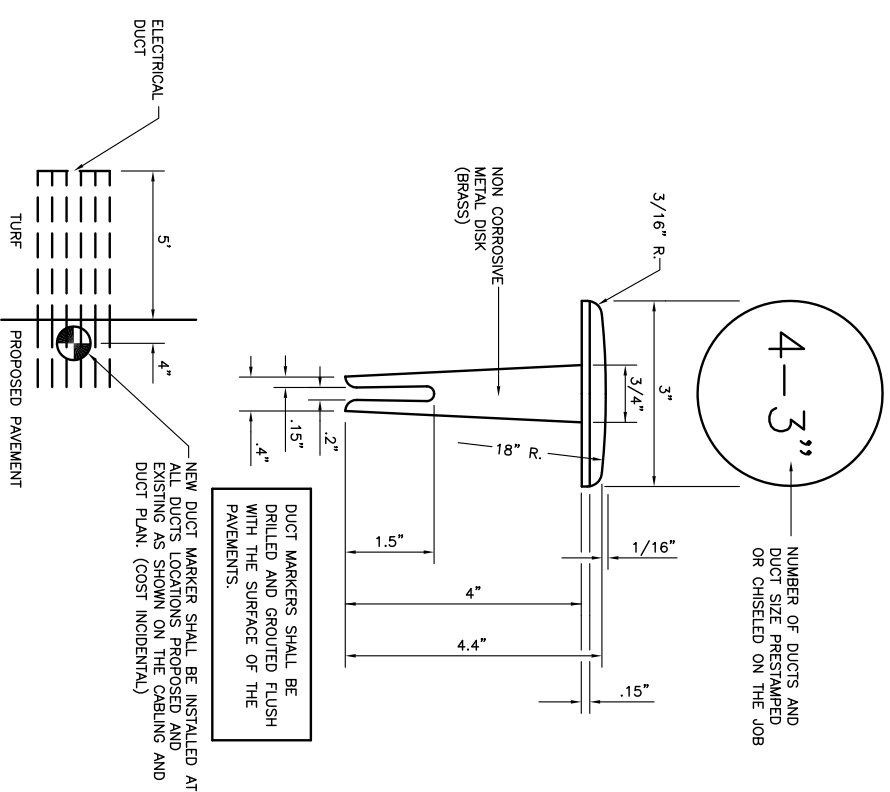

DUCT MARKER DETAIL

NOT TO SCALE

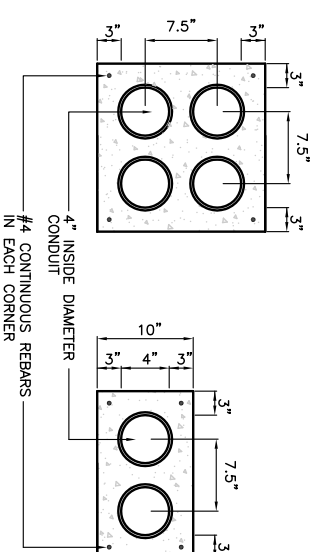

CONCRETE ENCASED DUCT BANKS

NOT TO SCALE

NOTES:

1. DIMENSIONS ARE MINIMUM.
2. CONCRETE SHALL CONFORM TO ITEM 610.
3. ALL CONDUIT SHALL BE SCHEDULE 40 PVC.
4. TOP OF CONCRETE ENCASMENT IN TURF AREAS SHALL NOT BE LESS THAN 24" BELOW SUBGRADE.
5. 4" SPLIT DUCT SHALL BE CONCRETE ENCASED WITH 3" MINIMUM CONCRETE SURROUNDING 4" CONDUIT. COST INCIDENTAL TO SPLIT DUCT.

K:\Chicago\ee\p\0829008.txd E:\Draw\Sheets\Towhee
FILE: txy-elec-dt-1.dwg
LAYOUT: Layout1
UPDATE BY: mtkatz
SURVEY BOOK #
DATE: Fri 4/1/11 9:19am
XREF DWG: tb.dwg
tbcont.dwg
tblcint_txy.dwg

NUMBER	BY	DATE

0 1 2
THIS BAR IS EQUAL TO 2" AT FULL SCALE (34X22).

**CHICAGO EXECUTIVE AIRPORT
WHEELING/PROSPECT HEIGHTS, ILLINOIS
CONSTRUCT PARTIAL PARALLEL TAXIWAY ECHO AND
PARTIAL OVERLAY OF TAXIWAY ECHO**

ELECTRICAL DETAILS - SHEET 1

© Copyright CMT, Inc.
CMT
CRAWFORD, MURPHY & TILLY, INC.
CONSULTING ENGINEERS
License No. 184-000613



DESIGN BY:	MLK
DRAWN BY:	JRO
CHECKED BY:	MLK
APPROVED BY:	DLP
DATE:	04/22/11
JOB No.:	08290-08

ILLINOIS PROJECT: PWK-3244
A.I.P. PROJECT: 3-17-0018-B32

SHEET 30 OF 49 SHEETS