

STATE OF ILLINOIS
DEPARTMENT OF TRANSPORTATION

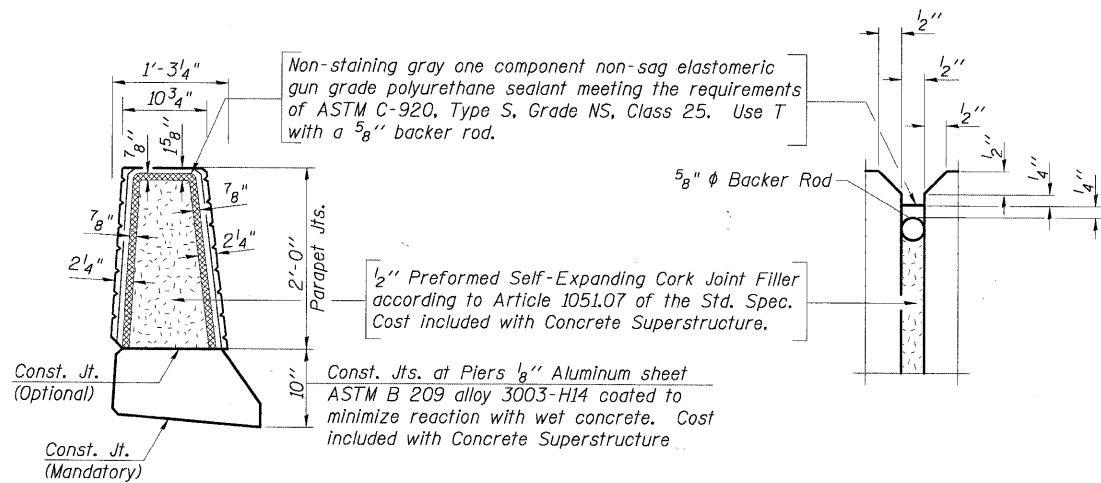

PARAPET JOINT DETAILS

Notes:

The exterior surfaces of the floor drains shall be painted with the finish coat as specified in the special provisions for Cleaning and Painting New Metal Structures. The exterior surfaces of the drains shall be cleaned according to Society of Protective Coatings Spec. SSPC-SP1 prior to painting.
Fiberglass pipe shall conform to ASTM D 2996, with short-time rupture strength hoop tensile stress of 30,000 p.s.i. minimum.

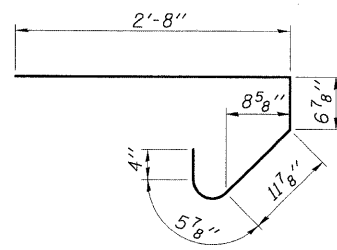

BAR s(E)

Notes:

Reinforcement bars in diaphragm are bitted with superstructure on sheet S-7.
Concrete in diaphragm is included with Concrete Superstructure on sheet S-7.
The s(E) and s₁(E) bars shall be placed parallel to the beams. Spacing for these bars shall be at right angles to the beams.
Epoxy grout d₅(E) bars in 6" (min.) drilled holes according to Section 584 of Standard Specification

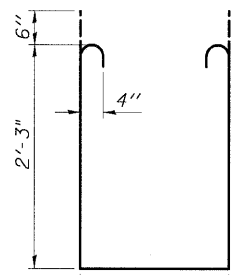

BAR s₁(E)

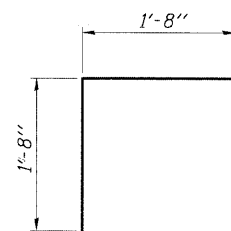

BAR v(E)

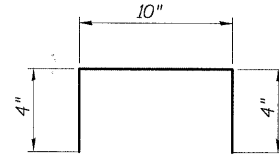

BAR u(E)

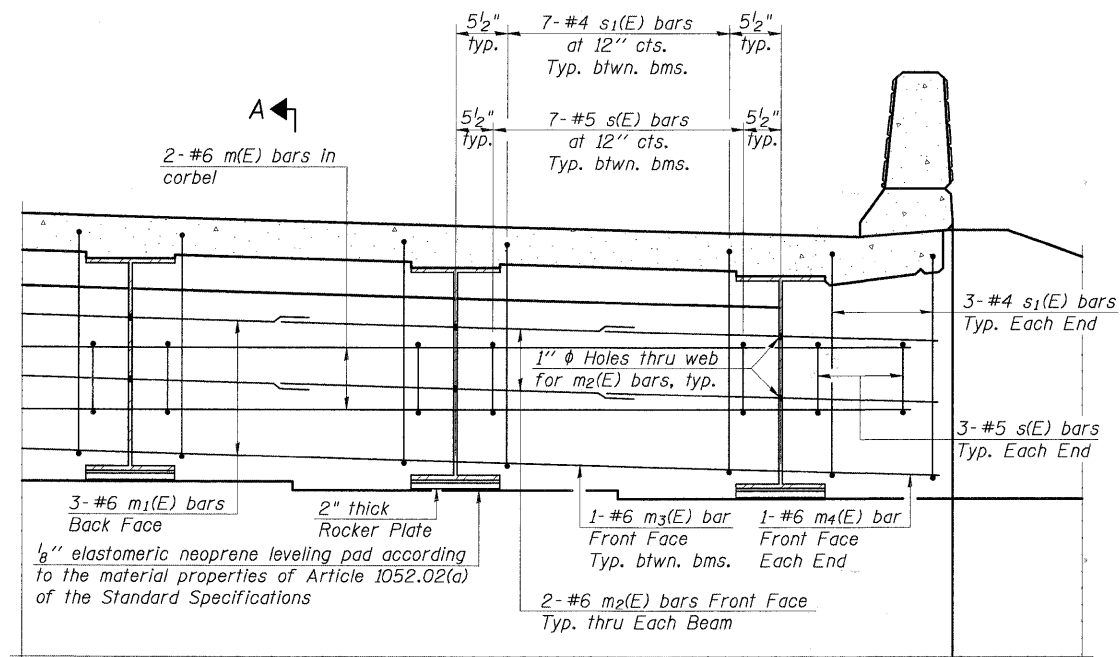

DIAPHRAGM ELEVATION AT ABUTMENT

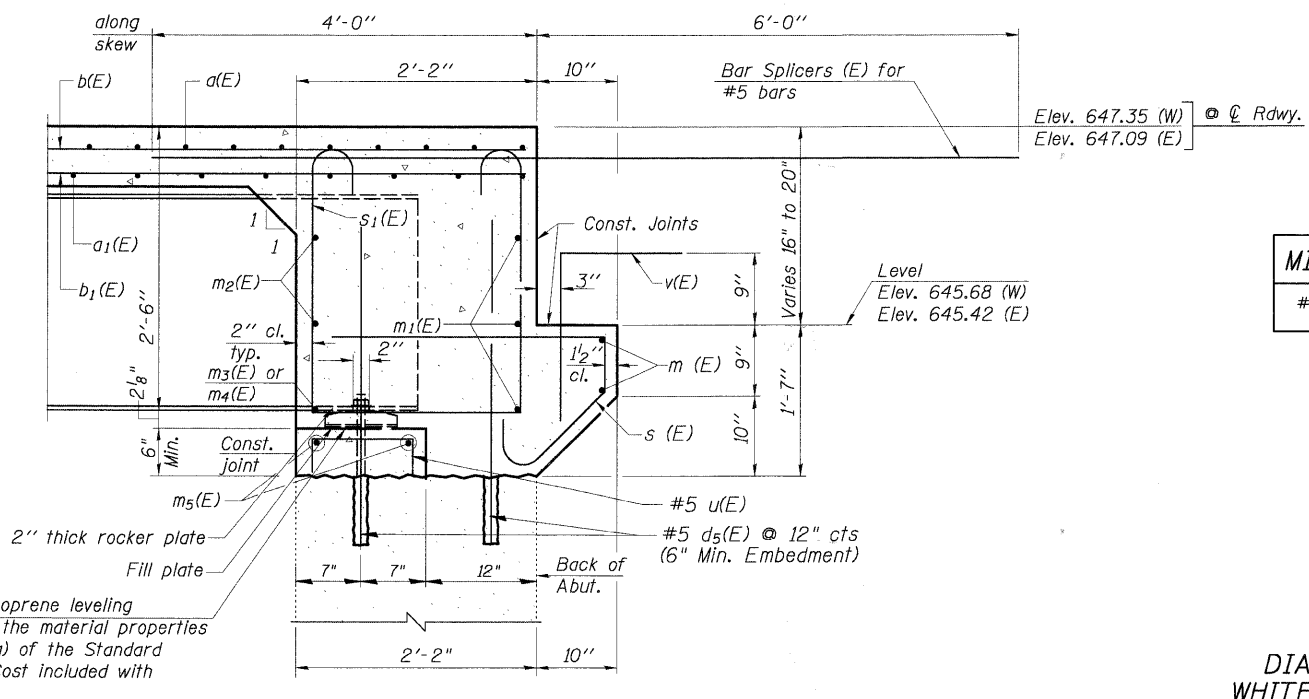

MIN. BAR LAP	
#6	2'-9"

SECTION A-A

Dimensions at right angles to abutment, except as shown.

DIAPHRAGM DETAILS
WHITEHALL AVENUE OVER
ADDISON CREEK
F.A. RTE. 4025
SECTION 09-00071-00-BR
COOK COUNTY
STATION 30+67.04
STRUCTURE No. 016-7618

DESIGNED -	200
CHECKED -	EXAMINED
DRAWN -	PASSED
CHECKED -	ENGINEER OF BRIDGES AND STRUCTURES

SHEET NO. S-8 SHEETS	F.A. RTE. 4025	SECTION 09-00071-00-BR	COUNTY COOK	TOTAL SHEETS 31	SHEET NO. 20
	CONTRACT NO. 63437				
FED. ROAD DIST. NO.		ILLINOIS FED. AID PROJECT			