

CHICAGO EXECUTIVE AIRPORT WHEELING/PROSPECT HEIGHTS, ILLINOIS

CONSTRUCTION PLANS FOR

CHICAGO EXECUTIVE AIRPORT

REHABILITATE RUNWAY 16/34 (BASE BID) INCLUDING AIRFIELD LIGHTING (ADDITIVE ALTERNATE 1)



811 Know what's below. Call before you dig.

J.U.L.I.E. JOINT UTILITY LOCATING INFORMATION FOR EXCAVATORS
www.illinois1call.com

THE LOCATION, SIZE AND TYPE OF MATERIAL OF EXISTING UNDERGROUND UTILITIES INDICATED ON THE PLANS IS NOT REPRESENTED AS BEING ACCURATE, SUFFICIENT OR COMPLETE IT SHALL BE THE CONTRACTOR'S RESPONSIBILITY TO DETERMINE ACTUAL LOCATIONS OF ALL SUCH FACILITIES, INCLUDING SERVICE CONNECTIONS TO UNDERGROUND UTILITIES. PRIOR TO CONSTRUCTION, THE CONTRACTOR SHALL NOTIFY UTILITY COMPANIES OF HIS OPERATIONAL PLANS, OBTAIN FROM RESPECTIVE UTILITY COMPANIES DETAILED INFORMATION AND ASSISTANCE RELATIVE TO THE LOCATION OF THEIR FACILITIES AND THE WORKING SCHEDULE OF THE COMPANIES FOR REMOVAL OR ADJUSTMENT WHERE REQUIRED. IN THE EVENT AN UNEXPECTED UTILITY INTERFERENCE IS ENCOUNTERED DURING CONSTRUCTION, THE CONTRACTOR SHALL IMMEDIATELY NOTIFY THE UTILITY COMPANY OF JURISDICTION AND THE ONE-CALL NOTICE SYSTEM. THE ENGINEER SHALL ALSO BE IMMEDIATELY NOTIFIED. ANY SUCH UTILITY OR SERVICES SHALL BE RESTORED TO SERVICE AT ONCE AND PAID FOR BY THE CONTRACTOR AT NO ADDITIONAL COST TO THE CONTRACT.

CALL J.U.L.I.E. FOR UTILITY INFORMATION AT 811.

ILLINOIS PROJECT: PWK-4414
S.B.G. PROJECT: 3-17-SBGP-XX



DATE: JUNE 19, 2015

CHICAGO EXECUTIVE AIRPORT

TOWNSHIP: 42 NORTH WHEELING TOWNSHIP
RANGE: 11 EAST (SECTION: 13)
COOK COUNTY

CMT 14290-05
CRAWFORD MURPHY & TILLY, INC.
CONSULTING ENGINEERS

SUBMITTED BY *Sean M. Smith*
SEAN M. SMITH, P.E.

DATE 17 JUNE 2015

CHICAGO EXECUTIVE AIRPORT

APPROVED *Jamie Abbott* EXECUTIVE DIRECTOR
JAMIE ABBOTT

DATE 11 June 2015

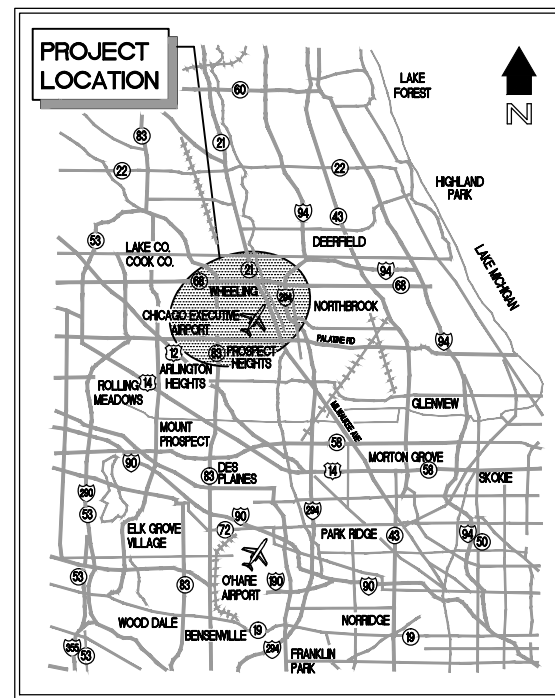

LOCATION MAP

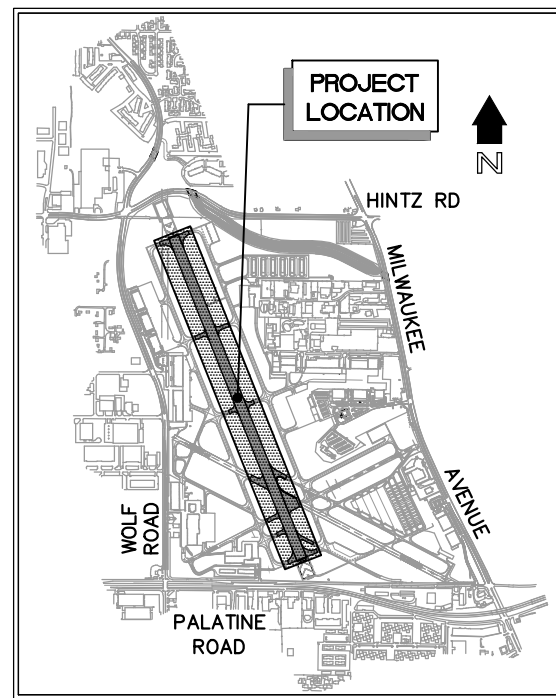

SITE PLAN

PROJECT INFORMATION

CONTRACTOR:
RESIDENT ENGINEER:
ORIGINAL CONTRACT AMOUNT:
FINAL CONSTRUCTION COST:
IDOT LETTING DATE:
IDOT AWARD DATE:
NOTICE TO PROCEED:
START OF CONSTRUCTION:
SUBSTANTIAL COMPLETION:

LOCAL AGENCY CONTACT INFORMATION

VILLAGE OF WHEELING - 847.459.2600
CITY OF PROSPECT HEIGHTS - 847.398.6070

ENGINEER'S PROJECT PERMIT LOG

NPDES #
FAA AIRSPACE #
CCDD LPC-663 DATED 11/16/12
MWRDGC PERMIT # 03-246 & RL 09-063
VILLAGE APP FOR CONSTRUCTION PERMIT #
VILLAGE FLOODPLAIN PERMIT #
CONTRACTORS REGISTRATION WITH VILLAGE
VILLAGE SITE ALTERATION PERMIT #
CITY APPLICATION FOR PERMIT #
CITY FLOODPLAIN PERMIT #
CITY SITE GRADING PERMIT #
CONTRACTOR'S REGISTRATION WITH CITY

DATE: Thursday, July 9, 2015 09:23:30
 FILE: K:\Chicago\cdwg\14290-05_RehabRW16-34\Draw\Sheets\02_INDEX_AND_S00.dwg
 UPDATE BY: Sean Smith
 LAYOUT: 02_INDEX_AND_S00
 IMAGE FILES: pwknewLOGO_CEA-4-Color-Small (2).jpg
 XREF DWG: bchml_runway.dwg

SHEET LIST	
SHEET NUMBER	SHEET TITLE
01	COVER SHEET
02	INDEX TO SHEETS AND SUMMARY OF QUANTITIES
03	SITE PLAN AND PROJECT CONTROL POINT PLAN
04	SEQUENCE OF CONSTRUCTION PHASE 1
05	SEQUENCE OF CONSTRUCTION PHASE 2
06	SEQUENCE OF CONSTRUCTION PHASE 3
07	SEQUENCE OF CONSTRUCTION PHASE 4
08	SEQUENCE OF CONSTRUCTION PHASE 5
09	SEQUENCE OF CONSTRUCTION GENERAL NOTES AND DETAILS 1
10	SEQUENCE OF CONSTRUCTION GENERAL NOTES AND DETAILS 1
11	SEQUENCE OF CONSTRUCTION SUGGESTED SCHEDULE AND DURATION
12	STORM WATER POLLUTION PREVENTION PLAN
13	STORM WATER POLLUTION PREVENTION PLAN NOTES AND DETAILS SHEET 1
14	STORM WATER POLLUTION PREVENTION PLAN NOTES AND DETAILS SHEET 2
15	TYPICAL SECTIONS - RUNWAY 16-34
16	TYPICAL SECTIONS - ALL TAXIWAYS AND RUNWAYS 6-24 AND 12-30
17	EXISTING CONDITIONS AND PROPOSED REMOVALS SHEET 1
18	EXISTING CONDITIONS AND PROPOSED REMOVALS SHEET 2
19	EXISTING CONDITIONS AND PROPOSED REMOVALS SHEET 3
20	EXISTING CONDITIONS AND PROPOSED REMOVALS SHEET 4
21	EXISTING CONDITIONS AND PROPOSED REMOVALS SHEET 5
22	RUNWAY 16-34 PLAN AND PROFILE SHEET 1
23	RUNWAY 16-34 PLAN AND PROFILE SHEET 2
24	RUNWAY 16-34 PLAN AND PROFILE SHEET 3
25	RUNWAY 16-34 PLAN AND PROFILE SHEET 4
26	RUNWAY 16-34 PLAN AND PROFILE SHEET 5
27	TAXIWAY K AND L PLAN AND PROFILE
28	TAXIWAY K2 AND L2 PLAN AND PROFILE
29	TAXIWAY K3 AND L3 PLAN AND PROFILE
30	TAXIWAY E PLAN AND PROFILE
31	RUNWAY 12-30 PLAN AND PROFILE
32	RUNWAY 6-24 PLAN AND PROFILE
33	TAXIWAY L4 PLAN AND PROFILE
34	TAXIWAY D PLAN AND PROFILE
35	TAXIWAY K5 AND L5 PLAN AND PROFILE
36	INTERSECTION GRADING PLAN RUNWAYS 6-24, 12-30 AND 16-34
37	INTERSECTION GRADING PLAN TAXIWAYS D, L4, K5 AND L5
38	INTERSECTION GRADING PLAN TAXIWAYS K2, L2, K3 AND L3
39	INTERSECTION GRADING PLAN TAXIWAYS K AND L
40	BITUMINOUS MILLING DEPTH TABLE RUNWAY 16-34
41	SHOULDER AND STRUCTURE ADJUSTMENT DETAILS
42	PAVEMENT MARKING SHEET 1
43	PAVEMENT MARKING SHEET 2
44	PAVEMENT MARKING SHEET 3
45	PAVEMENT MARKING SHEET 4
46	PAVEMENT MARKING SHEET 5
47	PAVEMENT MARKING DETAILS
48	ELECTRICAL IMPROVEMENTS SHEET 1
49	ELECTRICAL IMPROVEMENTS SHEET 2
50	ELECTRICAL IMPROVEMENTS SHEET 3
51	ELECTRICAL IMPROVEMENTS SHEET 4
52	ELECTRICAL IMPROVEMENTS SHEET 5
53	RUNWAY 16-34 HOMERUN PLAN
54	VAULT IMPROVEMENTS
55	ELECTRICAL DETAILS SHEET 1
56	ELECTRICAL DETAILS SHEET 2
57	ELECTRICAL DETAILS SHEET 3
58	GROOVING PLAN AND DETAILS

SUMMARY OF QUANTITIES

BASE BID CONSTRUCTION - REHABILITATE RUNWAY 16/34 PAVEMENT				
ITEM NO.	DESCRIPTION	UNIT	ESTIMATED QUANTITY	RECORD QUANTITY
AR110947	ADJUST ELECTRICAL MANHOLE	EACH	17	
AR125470	MODIFY EXISTING SIGN PANEL	EACH	1	
AR125923	REPLACE INPAVEMENT LIGHT	EACH	8	
AR150510	ENGINEER'S FIELD OFFICE	LS	1	
AR150520	MOBILIZATION	LS	1	
AR152480	SHOULDER ADJUSTMENT	SY	14,140	
AR156510	SILT FENCE	LF	2,000	
AR156520	INLET PROTECTION	EACH	20	
AR201661	CLEAN & SEAL BITUMINOUS CRACKS	LF	15,000	
AR201663	SAND MIX CRACK REPAIR	LF	1,500	
AR401610	BITUMINOUS SURFACE COURSE	TON	21,450	
AR401630	BITUMINOUS SURFACE TEST SECTION	EACH	1	
AR401640	BITUMINOUS PAVEMENT GROOVING	SY	75,050	
AR401650	BITUMINOUS PAVEMENT MILLING	SY	83,345	
AR401655	BUTT JOINT CONSTRUCTION	SY	22,955	
AR603510	BITUMINOUS TACK COAT	GAL	28,400	
AR620520	PAVEMENT MARKING-WATERBORNE	SF	122,520	
AR620590	TEMPORARY MARKING	SF	217,730	
AR705945	ADJUST COLLECTION STRUCTURE	EACH	6	
AR751943	ADJUST MANHOLE	EACH	1	
AR800131	REMOVE LAHSO LIGHT INSTALLATION	LS	1	
AR800132	LAHSO LIGHT INSTALLATION	LS	1	
AR901510	SEEDING	ACRE	3	
AR904510	SODDING	SY	5,700	
AR908515	HEAVY-DUTY HYDRAULIC MULCH	ACRE	3	
ADDITIVE ALTERNATIVE 1 - REHABILITATE RUNWAY 16/34 LIGHTING				
ITEM NO.	DESCRIPTION	UNIT	ESTIMATED QUANTITY	ESTIMATED UNIT PRICE
AS108108	1/C #8 5 KV UG CABLE	LF	20,000	
AS109210	VAULT MODIFICATIONS	LS	1	
AS109362	30 KW REGULATOR, STYLE 2	EACH	1	
AS110202	2" PVC DUCT, DIRECT BURY	LF	4,500	
AS125565	SPLICE CAN	EACH	6	
AS125922	REPLACE BASE MOUNTED LIGHT	EACH	42	
AS125924	REPLACE TAXI GUIDANCE SIGN	EACH	4	

NOTES

- SPECIAL ATTENTION IS NECESSARY WHEN WORKING NEAR FAA POWER AND CONTROL CABLES. ANY FAA UTILITY THAT IS DAMAGED OR CUT DURING CONSTRUCTION SHALL BE REPAIRED IMMEDIATELY. **FAA REQUIRES THAT ANY DAMAGED CABLE BE REPLACED IN ITS ENTIRETY, FROM POWER/CONTROL SOURCE TO THE EQUIPMENT/SERVICE. SPLICES OF ANY KIND WILL NOT BE PERMITTED.** EXPOSURES OF ANY FAA CABLES MUST BE DONE BY HAND DIGGING OR HYDRO-EXCAVATION. NO ADDITIONAL COMPENSATION WILL BE MADE FOR LOCATING, REPLACEMENT OR REPAIR OF FAA FACILITIES OR CABLES BUT, SHALL BE INCIDENTAL TO THE CONTRACT.
- WHEN FAA CABLES ARE REQUIRED TO BE LOCATED, OR THE CONTRACTOR IS PLANNING ON WORKING ON OR AROUND FAA CABLES, CONDUITS OR EQUIPMENT, A 10 WORKING DAY ADVANCED NOTICE SHALL BE GIVEN TO THE FAA BEFORE ANY SUCH MARKINGS ARE REQUIRED. ONCE FAA MARKS THE CABLES, THE CONTRACTOR WILL BE REQUIRED TO SURVEY THE FAA UTILITIES SO THEY CAN BE REPLACED DURING CONSTRUCTION WITHOUT REMARKING BY THE FAA. THIS SHALL BE INCIDENTAL TO THE CONTRACT. THE FAA PERSONNEL ARE ONLY AVAILABLE FROM 9 AM TO 3 PM, MONDAY THROUGH FRIDAY WITH ADVANCED NOTICE.
- ALL ELEVATIONS SHOWN ON PLANS ARE IN 1929 DATUM. SUBTRACT 0.24 FEET FROM ELEVATIONS SHOWN TO OBTAIN 1988 NAVD.

MUNICIPALITIES GENERAL NOTES

- THE CHICAGO EXECUTIVE AIRPORT IS A JOINT OWNERSHIP BY BOTH THE VILLAGE OF WHEELING AND CITY OF PROSPECT HEIGHTS. ALL WORK SHALL BE PERFORMED IN ACCORDANCE WITH VILLAGE AND CITY CODES, ORDINANCES AND STANDARDS AS APPLICABLE.
- ALL CONTRACTORS AND SUBCONTRACTORS SHALL BE REGISTERED WITH THE VILLAGE AND CITY PRIOR TO THE NOTICE TO PROCEED. ALL REGISTRATION FEES SHALL BE INCIDENTAL TO THE CONTRACT.
- THE CONTRACTOR SHALL WORK WITH THE AIRPORT AND ENGINEER TO SECURE THE REQUIRED VILLAGE AND CITY LOCAL CONSTRUCTION PERMITS PRIOR TO THE NOTICE TO PROCEED.
- THE CONTRACTOR SHALL COORDINATE WITH THE VILLAGE AND CITY AT THE WEEKLY PROGRESS MEETINGS AND SHALL NOTIFY THE CITY OF PROSPECT HEIGHTS (847.398.6700) AND THE VILLAGE OF WHEELING (847.459.2600) A MINIMUM OF 48 HOURS PRIOR TO ANY REQUIRED VILLAGE/CITY INSPECTIONS.
- ALL STORM SEWERS AND SANITARY SEWERS ON THE AIRPORT SITE ARE OWNED, OPERATED AND MAINTAINED BY THE CHICAGO EXECUTIVE AIRPORT UNLESS LABELED OTHERWISE.

IL. CONTRACT: **PA059**
 IL. LETTING ITEM: **18A**
 IL. PROJECT: **PWK-4414**
 S.B.G. PROJECT: **3-17-SBGP-XX**

SURVEY BOOK # 1302

REVISIONS

NUMBER	BY	DATE

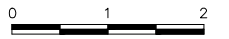
 THIS BAR IS EQUAL TO 2"
 AT FULL SCALE (34X22).

**CHICAGO EXECUTIVE AIRPORT
 WHEELING/PROSPECT HEIGHTS, ILLINOIS
 REHABILITATE RUNWAY 16/34**

**INDEX TO SHEETS AND
 SUMMARY OF QUANTITIES**

© Copyright CMT, Inc.



CMT
 CRAWFORD, MURPHY & TILLY, INC.
 CONSULTING ENGINEERS
 License No. 184-000613



DESIGN BY:	SMS
DRAWN BY:	JRO
CHECKED BY:	SMS
APPROVED BY:	DKP
DATE:	06/19/2015
JOB No:	14290-05-00

FINAL

REF DWG: 16chicgo_executive_airport.dwg
 C:\Users\jg34\OneDrive\Documents\16chicgo_executive_airport.dwg

IMAGE FILES: pwknewLOGO_CEA-4-Color-Small (2).jpg

UPDATE BY: Sean Smith
 LAYOUT: 03 SITE PLAN

DATE: Thursday, July 9, 2015, 09:23:54
 FILE: K:\ChicagoExec\14290-05-16chicgo_executive_airport.dwg

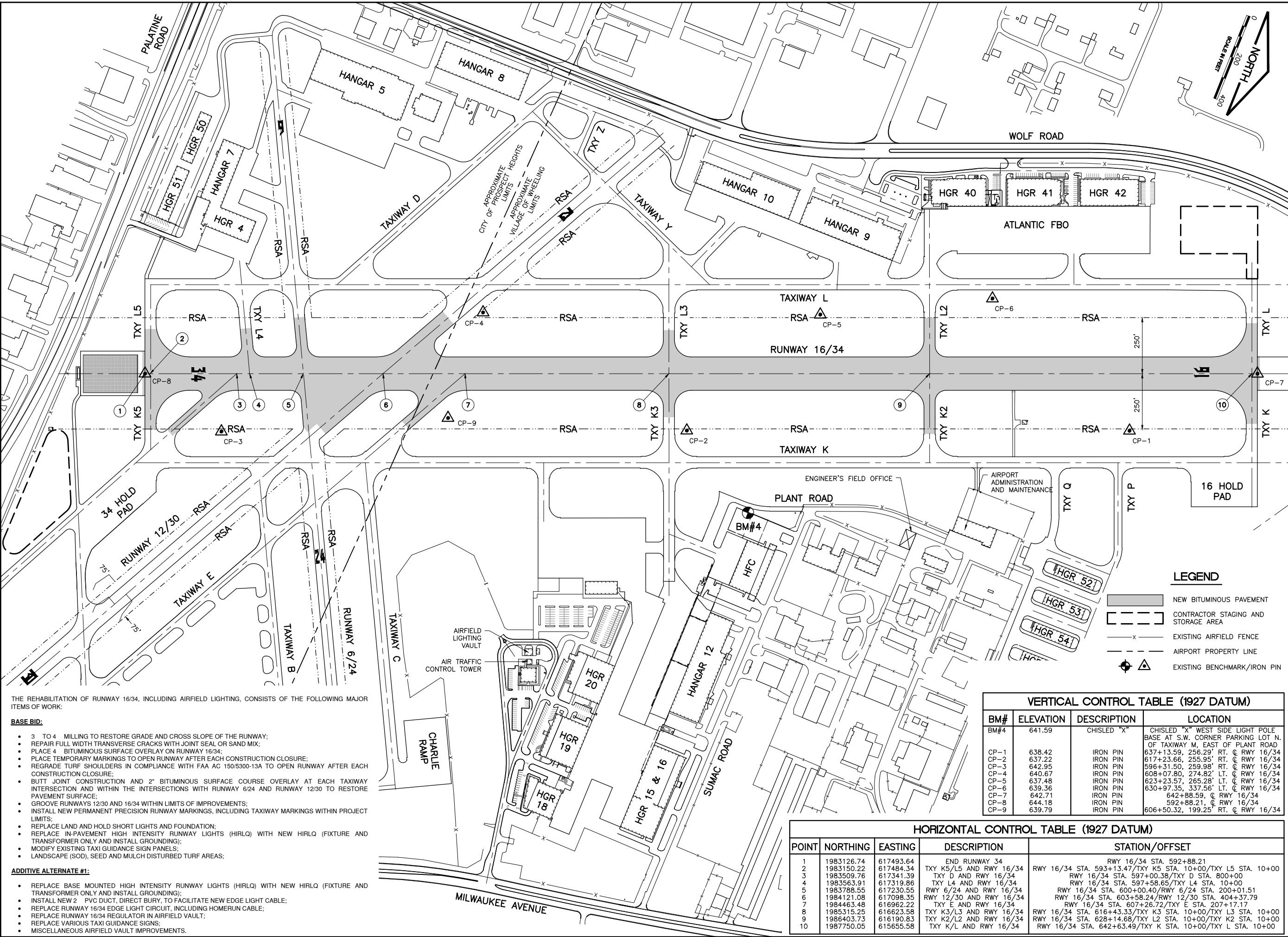

IL CONTRACT: PA059
 IL LETTING ITEM: 18A
 IL PROJECT: PWK-4414
 S.B.G. PROJECT: 3-17-SBGP-XX

SURVEY BOOK # 1302

REVISIONS		
NUMBER	BY	DATE

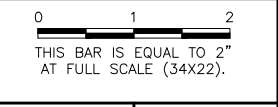

**CHICAGO EXECUTIVE AIRPORT
 WHEELING/PROSPECT HEIGHTS, ILLINOIS
 REHABILITATE RUNWAY 16/34
 PROJECT CONTROL POINT PLAN**

LEGEND

- NEW BITUMINOUS PAVEMENT
- CONTRACTOR STAGING AND STORAGE AREA
- EXISTING AIRFIELD FENCE
- AIRPORT PROPERTY LINE
- EXISTING BENCHMARK/IRON PIN

THE REHABILITATION OF RUNWAY 16/34, INCLUDING AIRFIELD LIGHTING, CONSISTS OF THE FOLLOWING MAJOR ITEMS OF WORK:

- BASE BID:**
- 3 TO 4 MILLING TO RESTORE GRADE AND CROSS SLOPE OF THE RUNWAY;
 - REPAIR FULL WIDTH TRANSVERSE CRACKS WITH JOINT SEAL OR SAND MIX;
 - PLACE 4 BITUMINOUS SURFACE OVERLAY ON RUNWAY 16/34;
 - PLACE TEMPORARY MARKINGS TO OPEN RUNWAY AFTER EACH CONSTRUCTION CLOSURE;
 - REGRADE TURF SHOULDERS IN COMPLIANCE WITH FAA AC 150/5300-13A TO OPEN RUNWAY AFTER EACH CONSTRUCTION CLOSURE;
 - BUTT JOINT CONSTRUCTION AND 2" BITUMINOUS SURFACE COURSE OVERLAY AT EACH TAXIWAY INTERSECTION AND WITHIN THE INTERSECTIONS WITH RUNWAY 6/24 AND RUNWAY 12/30 TO RESTORE PAVEMENT SURFACE;
 - GROOVE RUNWAYS 12/30 AND 16/34 WITHIN LIMITS OF IMPROVEMENTS;
 - INSTALL NEW PERMANENT PRECISION RUNWAY MARKINGS, INCLUDING TAXIWAY MARKINGS WITHIN PROJECT LIMITS;
 - REPLACE LAND AND HOLD SHORT LIGHTS AND FOUNDATION;
 - REPLACE IN-PAVEMENT HIGH INTENSITY RUNWAY LIGHTS (HIRLO) WITH NEW HIRLO (FIXTURE AND TRANSFORMER ONLY AND INSTALL GROUNDING);
 - MODIFY EXISTING TAXI GUIDANCE SIGNS;
 - LANDSCAPE (SOD), SEED AND MULCH DISTURBED TURF AREAS;
- ADDITIVE ALTERNATE #1:**
- REPLACE BASE MOUNTED HIGH INTENSITY RUNWAY LIGHTS (HIRLO) WITH NEW HIRLO (FIXTURE AND TRANSFORMER ONLY AND INSTALL GROUNDING);
 - INSTALL NEW 2" PVC DUCT, DIRECT BURY, TO FACILITATE NEW EDGE LIGHT CABLE;
 - REPLACE RUNWAY 16/34 EDGE LIGHT CIRCUIT, INCLUDING HOMERUN CABLE;
 - REPLACE RUNWAY 16/34 REGULATOR IN AIRFIELD VAULT;
 - REPLACE VARIOUS TAXI GUIDANCE SIGNS;
 - MISCELLANEOUS AIRFIELD VAULT IMPROVEMENTS.

VERTICAL CONTROL TABLE (1927 DATUM)

BM#	ELEVATION	DESCRIPTION	LOCATION
BM#4	641.59	CHISLED "X"	CHISLED "X" WEST SIDE LIGHT POLE BASE AT S.W. CORNER PARKING LOT N. OF TAXIWAY M, EAST OF PLANT ROAD
CP-1	638.42	IRON PIN	637+13.59, 256.29' RT. @ RWY 16/34
CP-2	637.22	IRON PIN	617+23.66, 255.95' RT. @ RWY 16/34
CP-3	642.95	IRON PIN	596+31.50, 259.98' RT. @ RWY 16/34
CP-4	640.67	IRON PIN	608+07.80, 274.82' LT. @ RWY 16/34
CP-5	637.48	IRON PIN	623+23.57, 265.28' LT. @ RWY 16/34
CP-6	639.36	IRON PIN	630+97.35, 337.56' LT. @ RWY 16/34
CP-7	642.71	IRON PIN	642+88.59, @ RWY 16/34
CP-8	644.18	IRON PIN	592+88.21, @ RWY 16/34
CP-9	639.79	IRON PIN	606+50.32, 199.25' RT. @ RWY 16/34

HORIZONTAL CONTROL TABLE (1927 DATUM)

POINT	NORTHING	EASTING	DESCRIPTION	STATION/OFFSET
1	1983126.74	617493.64	END RUNWAY 34	RWY 16/34 STA. 592+88.21
2	1983150.22	617484.34	TXY K5/L5 AND RWY 16/34	RWY 16/34 STA. 593+13.47/TXY K5 STA. 10+00/TXY L5 STA. 10+00
3	1983509.76	617341.39	TXY D AND RWY 16/34	RWY 16/34 STA. 597+00.38/TXY D STA. 800+00
4	1983563.91	617319.86	TXY L4 AND RWY 16/34	RWY 16/34 STA. 597+58.65/TXY L4 STA. 10+00
5	1983788.55	617230.55	RWY 6/24 AND RWY 16/34	RWY 16/34 STA. 600+00.40/RWY 6/24 STA. 200+01.51
6	1984121.08	617098.35	RWY 12/30 AND RWY 16/34	RWY 16/34 STA. 603+58.24/RWY 12/30 STA. 404+37.79
7	1984463.48	616982.22	TXY E AND RWY 16/34	RWY 16/34 STA. 607+26.72/TXY E STA. 207+17.17
8	1985315.25	616623.58	TXY K3/L3 AND RWY 16/34	RWY 16/34 STA. 616+43.33/TXY K3 STA. 10+00/TXY L3 STA. 10+00
9	1986403.73	616190.83	TXY K2/L2 AND RWY 16/34	RWY 16/34 STA. 628+14.68/TXY L2 STA. 10+00/TXY K2 STA. 10+00
10	1987750.05	615655.58	TXY K/L AND RWY 16/34	RWY 16/34 STA. 642+63.49/TXY K STA. 10+00/TXY L STA. 10+00

© Copyright CMT, Inc.

CMT
 CRAWFORD, MURPHY & TILLY, INC.
 CONSULTING ENGINEERS
 License No. 184-000613

CHICAGO EXECUTIVE AIRPORT

DESIGN BY: SMS
 DRAWN BY: JRO
 CHECKED BY: SMS
 APPROVED BY: DKP
 DATE: 06/19/2015
 JOB No: 14290-05-00
FINAL
 SHEET 03 OF 58 SHEETS

REF: DWG: runway 16-34 base-NEW.dwg
 C:\A\Projects\14290-05-16-34\Drawings\16-34.dwg
 IMAGE FILES: pwrkml000_CEA-4-Color-Small (2).jpg
 UPDATE BY: Sean Smith
 LAYOUT: 04 SEQUENCE 1
 DATE: Thursday, July 9, 2015 09:24:23
 FILE: K:\Chicago\14290-05-16-34\Drawings\16-34.dwg

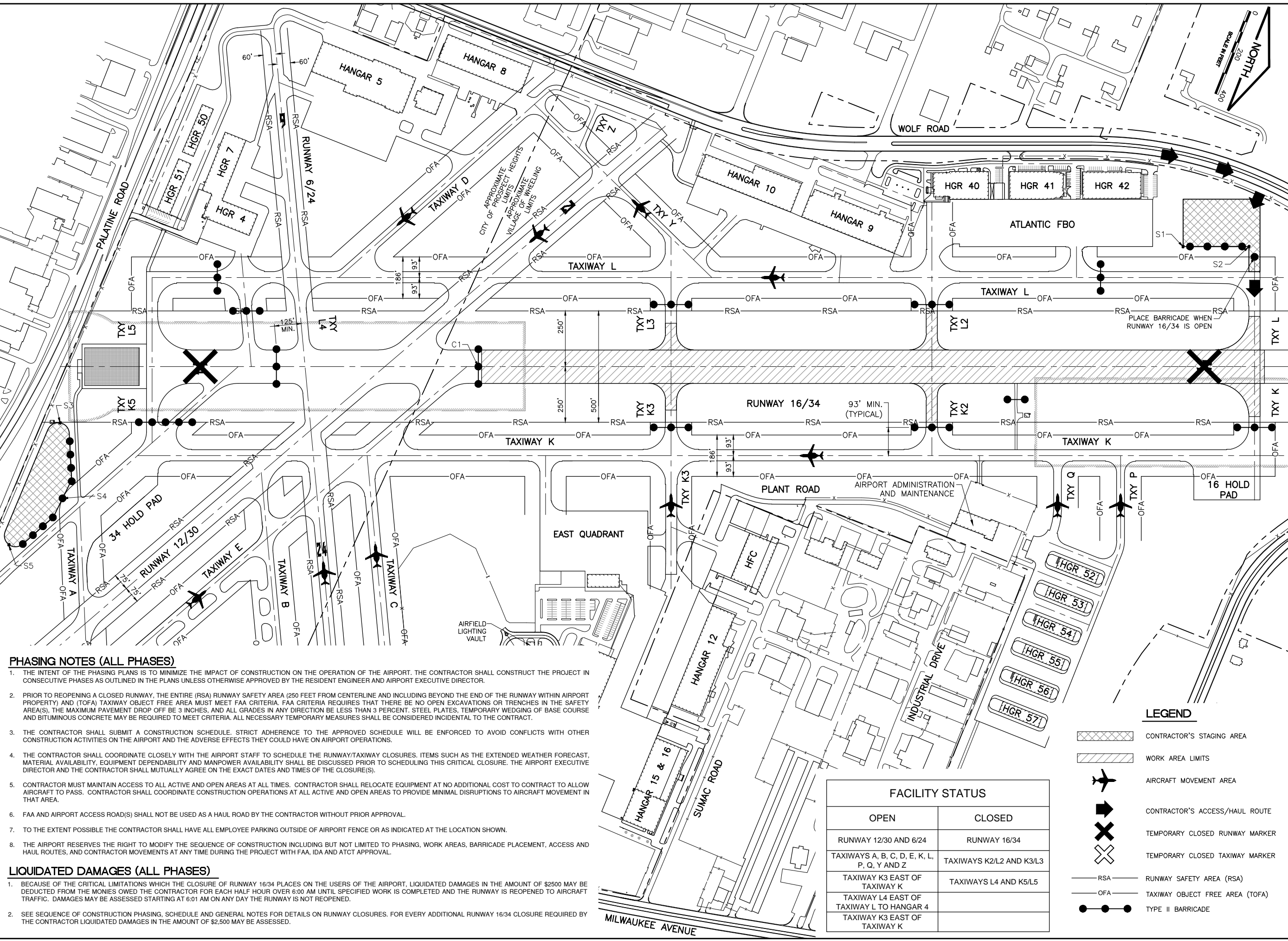

IL CONTRACT: PA059
 IL LETTING ITEM: 18A
 IL PROJECT: PWK-4414
 S.B.G. PROJECT: 3-17-SBGP-XX

SURVEY BOOK # 1302

REVISIONS		
NUMBER	BY	DATE

0 1 2
 THIS BAR IS EQUAL TO 2" AT FULL SCALE (34X22).

CHICAGO EXECUTIVE AIRPORT
WHEELING/PROSPECT HEIGHTS, ILLINOIS
REHABILITATE RUNWAY 16-34
SEQUENCE OF CONSTRUCTION
PHASE 1

PHASING NOTES (ALL PHASES)

1. THE INTENT OF THE PHASING PLANS IS TO MINIMIZE THE IMPACT OF CONSTRUCTION ON THE OPERATION OF THE AIRPORT. THE CONTRACTOR SHALL CONSTRUCT THE PROJECT IN CONSECUTIVE PHASES AS OUTLINED IN THE PLANS UNLESS OTHERWISE APPROVED BY THE RESIDENT ENGINEER AND AIRPORT EXECUTIVE DIRECTOR.
2. PRIOR TO REOPENING A CLOSED RUNWAY, THE ENTIRE (RSA) RUNWAY SAFETY AREA (250 FEET FROM CENTERLINE AND INCLUDING BEYOND THE END OF THE RUNWAY WITHIN AIRPORT PROPERTY) AND (TOFA) TAXIWAY OBJECT FREE AREA MUST MEET FAA CRITERIA. FAA CRITERIA REQUIRES THAT THERE BE NO OPEN EXCAVATIONS OR TRENCHES IN THE SAFETY AREA(S), THE MAXIMUM PAVEMENT DROP OFF BE 3 INCHES, AND ALL GRADES IN ANY DIRECTION BE LESS THAN 3 PERCENT. STEEL PLATES, TEMPORARY WEDGING OF BASE COURSE AND BITUMINOUS CONCRETE MAY BE REQUIRED TO MEET CRITERIA. ALL NECESSARY TEMPORARY MEASURES SHALL BE CONSIDERED INCIDENTAL TO THE CONTRACT.
3. THE CONTRACTOR SHALL SUBMIT A CONSTRUCTION SCHEDULE. STRICT ADHERENCE TO THE APPROVED SCHEDULE WILL BE ENFORCED TO AVOID CONFLICTS WITH OTHER CONSTRUCTION ACTIVITIES ON THE AIRPORT AND THE ADVERSE EFFECTS THEY COULD HAVE ON AIRPORT OPERATIONS.
4. THE CONTRACTOR SHALL COORDINATE CLOSELY WITH THE AIRPORT STAFF TO SCHEDULE THE RUNWAY/TAXIWAY CLOSURES. ITEMS SUCH AS THE EXTENDED WEATHER FORECAST, MATERIAL AVAILABILITY, EQUIPMENT DEPENDABILITY AND MANPOWER AVAILABILITY SHALL BE DISCUSSED PRIOR TO SCHEDULING THIS CRITICAL CLOSURE. THE AIRPORT EXECUTIVE DIRECTOR AND THE CONTRACTOR SHALL MUTUALLY AGREE ON THE EXACT DATES AND TIMES OF THE CLOSURE(S).
5. CONTRACTOR MUST MAINTAIN ACCESS TO ALL ACTIVE AND OPEN AREAS AT ALL TIMES. CONTRACTOR SHALL RELOCATE EQUIPMENT AT NO ADDITIONAL COST TO CONTRACT TO ALLOW AIRCRAFT TO PASS. CONTRACTOR SHALL COORDINATE CONSTRUCTION OPERATIONS AT ALL ACTIVE AND OPEN AREAS TO PROVIDE MINIMAL DISRUPTIONS TO AIRCRAFT MOVEMENT IN THAT AREA.
6. FAA AND AIRPORT ACCESS ROAD(S) SHALL NOT BE USED AS A HAUL ROAD BY THE CONTRACTOR WITHOUT PRIOR APPROVAL.
7. TO THE EXTENT POSSIBLE THE CONTRACTOR SHALL HAVE ALL EMPLOYEE PARKING OUTSIDE OF AIRPORT FENCE OR AS INDICATED AT THE LOCATION SHOWN.
8. THE AIRPORT RESERVES THE RIGHT TO MODIFY THE SEQUENCE OF CONSTRUCTION INCLUDING BUT NOT LIMITED TO PHASING, WORK AREAS, BARRICADE PLACEMENT, ACCESS AND HAUL ROUTES, AND CONTRACTOR MOVEMENTS AT ANY TIME DURING THE PROJECT WITH FAA, IDA AND ATCT APPROVAL.

LIQUIDATED DAMAGES (ALL PHASES)

1. BECAUSE OF THE CRITICAL LIMITATIONS WHICH THE CLOSURE OF RUNWAY 16/34 PLACES ON THE USERS OF THE AIRPORT, LIQUIDATED DAMAGES IN THE AMOUNT OF \$2500 MAY BE DEDUCTED FROM THE MONIES OWED THE CONTRACTOR FOR EACH HALF HOUR OVER 6:00 AM UNTIL SPECIFIED WORK IS COMPLETED AND THE RUNWAY IS REOPENED TO AIRCRAFT TRAFFIC. DAMAGES MAY BE ASSESSED STARTING AT 6:01 AM ON ANY DAY THE RUNWAY IS NOT REOPENED.
2. SEE SEQUENCE OF CONSTRUCTION PHASING, SCHEDULE AND GENERAL NOTES FOR DETAILS ON RUNWAY CLOSURES. FOR EVERY ADDITIONAL RUNWAY 16/34 CLOSURE REQUIRED BY THE CONTRACTOR LIQUIDATED DAMAGES IN THE AMOUNT OF \$2,500 MAY BE ASSESSED.

FACILITY STATUS	
OPEN	CLOSED
RUNWAY 12/30 AND 6/24	RUNWAY 16/34
TAXIWAYS A, B, C, D, E, K, L, P, Q, Y AND Z	TAXIWAYS K2/L2 AND K3/L3
TAXIWAY K3 EAST OF TAXIWAY K	TAXIWAYS L4 AND K5/L5
TAXIWAY L4 EAST OF TAXIWAY L TO HANGAR 4	
TAXIWAY K3 EAST OF TAXIWAY K	

LEGEND

- CONTRACTOR'S STAGING AREA
- WORK AREA LIMITS
- AIRCRAFT MOVEMENT AREA
- CONTRACTOR'S ACCESS/HAUL ROUTE
- TEMPORARY CLOSED RUNWAY MARKER
- TEMPORARY CLOSED TAXIWAY MARKER
- RSA - RUNWAY SAFETY AREA (RSA)
- OFA - TAXIWAY OBJECT FREE AREA (TOFA)
- TYPE II BARRICADE

© Copyright CMT, Inc.
CMT
 CRAWFORD, MURPHY & TILLY, INC.
 CONSULTING ENGINEERS
 License No. 184-000613

CHICAGO EXECUTIVE AIRPORT

DESIGN BY:	SMS
DRAWN BY:	JRO
CHECKED BY:	SMS
APPROVED BY:	DKP
DATE:	06/19/2015
JOB No:	14290-05-00

FINAL

SHEET 04 OF 58 SHEETS

DATE: Thursday, July 9, 2015 09:24:44
 FILE: K:\Chicago\esha\14290-05_RehabRwy16-34\Draw\Sheet\05_SEQUENCE_2.dwg
 UPDATE BY: Sean Smith
 LAYOUT: 05_SEQUENCE_2
 IMAGE FILES: pmknewLOGO_CEA-4_Color_Smol (2).jpg
 REF: DWG: runway_16-34_base-NEW.dwg
 bchm\runway.dwg

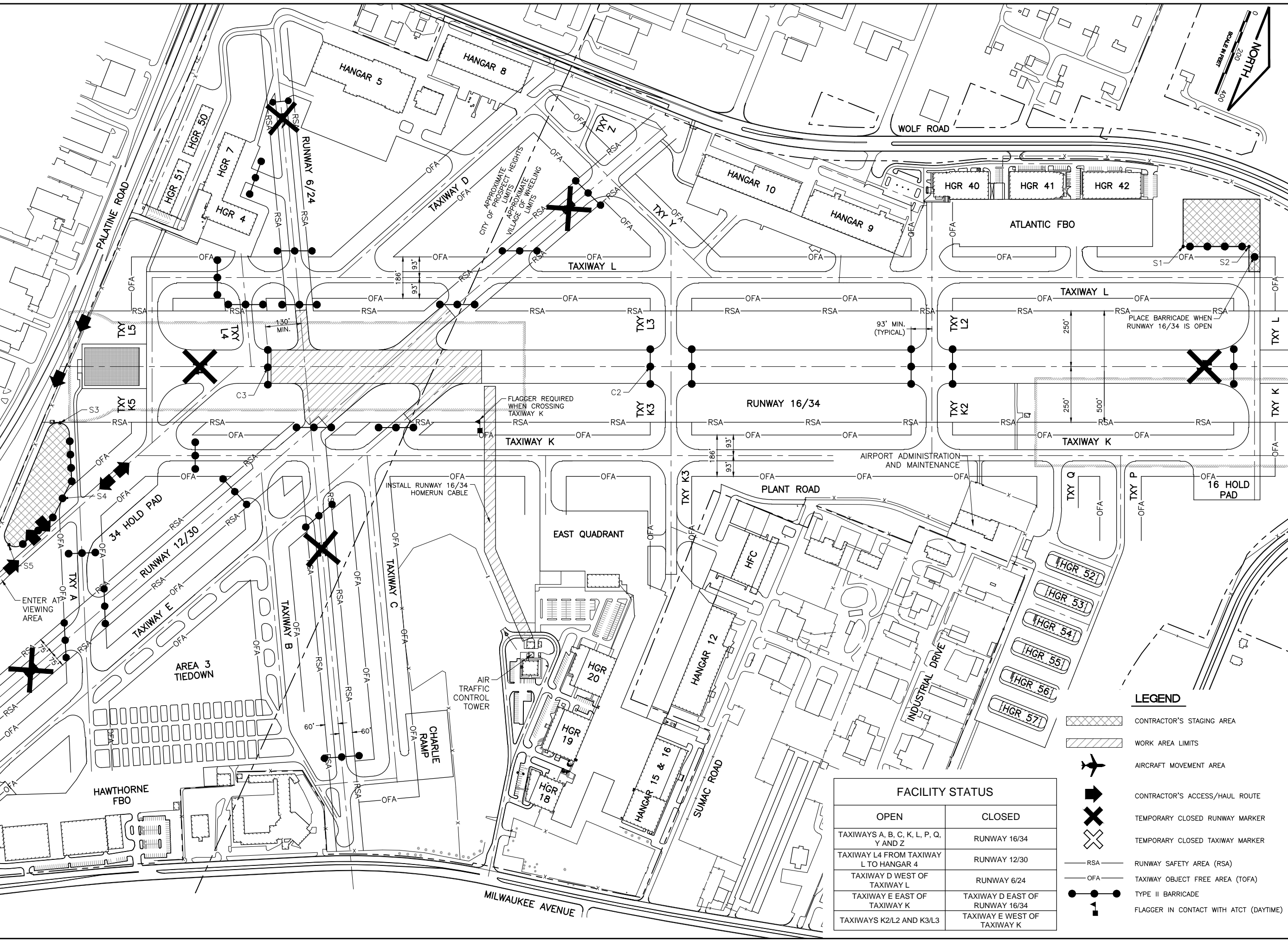

IL. CONTRACT: **PA059**
 IL. LETTING ITEM: **18A**
 IL. PROJECT: **PWK-4414**
 S.B.G. PROJECT: **3-17-SBGP-XX**

SURVEY BOOK # 1302

REVISIONS		
NUMBER	BY	DATE

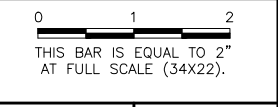

CHICAGO EXECUTIVE AIRPORT
WHEELING/PROSPECT HEIGHTS, ILLINOIS
REHABILITATE RUNWAY 16/34
SEQUENCE OF CONSTRUCTION
PHASE 2

FACILITY STATUS	
OPEN	CLOSED
TAXIWAYS A, B, C, K, L, P, Q, Y AND Z	RUNWAY 16/34
TAXIWAY L4 FROM TAXIWAY L TO HANGAR 4	RUNWAY 12/30
TAXIWAY D WEST OF TAXIWAY L	RUNWAY 6/24
TAXIWAY E EAST OF TAXIWAY K	TAXIWAY D EAST OF RUNWAY 16/34
TAXIWAYS K2/L2 AND K3/L3	TAXIWAY E WEST OF TAXIWAY K

- LEGEND**
- CONTRACTOR'S STAGING AREA
 - WORK AREA LIMITS
 - AIRCRAFT MOVEMENT AREA
 - CONTRACTOR'S ACCESS/HAUL ROUTE
 - TEMPORARY CLOSED RUNWAY MARKER
 - TEMPORARY CLOSED TAXIWAY MARKER
 - RSA
 - OFA
 - TYPE II BARRICADE
 - FLAGGER IN CONTACT WITH ATCT (DAYTIME)

© Copyright CMT, Inc.

CMT
 CRAWFORD, MURPHY & TILLY, INC.
 CONSULTING ENGINEERS
 License No. 184-000613

CHICAGO EXECUTIVE AIRPORT

DESIGN BY:	SMS
DRAWN BY:	JRO
CHECKED BY:	SMS
APPROVED BY:	DKP
DATE:	06/19/2015
JOB No:	14290-05-00

DATE: Thursday, July 9, 2015, 09:25:09
 FILE: K:\Chicago\14290-05-Relief\16-34\Draw\Sheet\06_SEQUENCE_3.dwg
 UPDATE BY: Sean Smith
 LAYOUT: 06_SEQUENCE_3
 IMAGE FILES: pmknewLOGO_CEA-4-Color-Small (2).jpg
 REF DWG: bchrt1_ranroy.dwg
 RANROY: 16-34_Dose-NEW.dwg

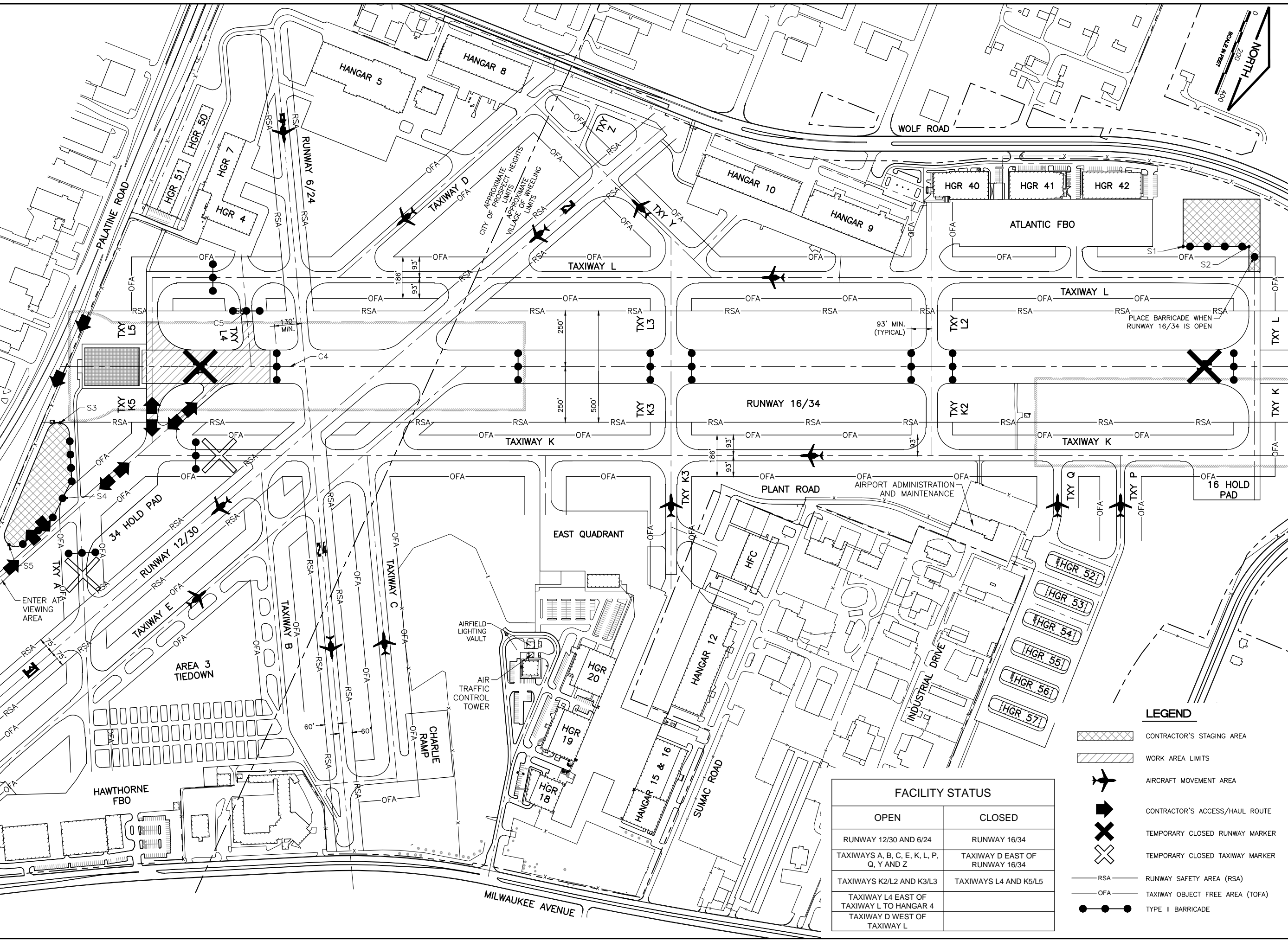

IL CONTRACT: PA059
 IL LETTING ITEM: 18A
 IL PROJECT: PWK-4414
 S.B.G. PROJECT: 3-17-SBGP-XX

SURVEY BOOK # 1302

REVISIONS		
NUMBER	BY	DATE

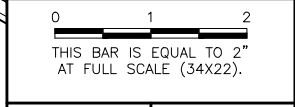

CHICAGO EXECUTIVE AIRPORT
WHEELING/PROSPECT HEIGHTS, ILLINOIS
REHABILITATE RUNWAY 16/34
SEQUENCE OF CONSTRUCTION
PHASE 3

© Copyright CMT, Inc.

CMT
 CRAWFORD, MURPHY & TILLY, INC.
 CONSULTING ENGINEERS
 License No. 184-000613

CHICAGO EXECUTIVE AIRPORT

DESIGN BY:	SMS
DRAWN BY:	JRO
CHECKED BY:	SMS
APPROVED BY:	DKP
DATE:	06/19/2015
JOB No:	14290-05-00

FACILITY STATUS	
OPEN	CLOSED
RUNWAY 12/30 AND 6/24	RUNWAY 16/34
TAXIWAYS A, B, C, E, K, L, P, Q, Y AND Z	TAXIWAY D EAST OF RUNWAY 16/34
TAXIWAYS K2/L2 AND K3/L3	TAXIWAYS L4 AND K5/L5
TAXIWAY L4 EAST OF TAXIWAY L TO HANGAR 4	
TAXIWAY D WEST OF TAXIWAY L	

- LEGEND**
- CONTRACTOR'S STAGING AREA
 - WORK AREA LIMITS
 - AIRCRAFT MOVEMENT AREA
 - CONTRACTOR'S ACCESS/HAUL ROUTE
 - TEMPORARY CLOSED RUNWAY MARKER
 - TEMPORARY CLOSED TAXIWAY MARKER
 - RSA
 - TOFA
 - TYPE II BARRICADE

DATE: Thursday, July 9, 2015, 09:25:34
 FILE: K:\Chicago\esha\14290-05_RehabRwy16-34\Draw\Sheet\07_SEQUENCE.dwg
 UPDATE BY: Sean Smith
 LAYOUT: 07_SEQUENCE 5
 IMAGE FILES: pmknewLOGO_CEA-4_Color_Smol (2).jpg
 REF DWG: bchrt1_ranroy.dwg
 RANROY: 16-34_Dose-NEW.dwg

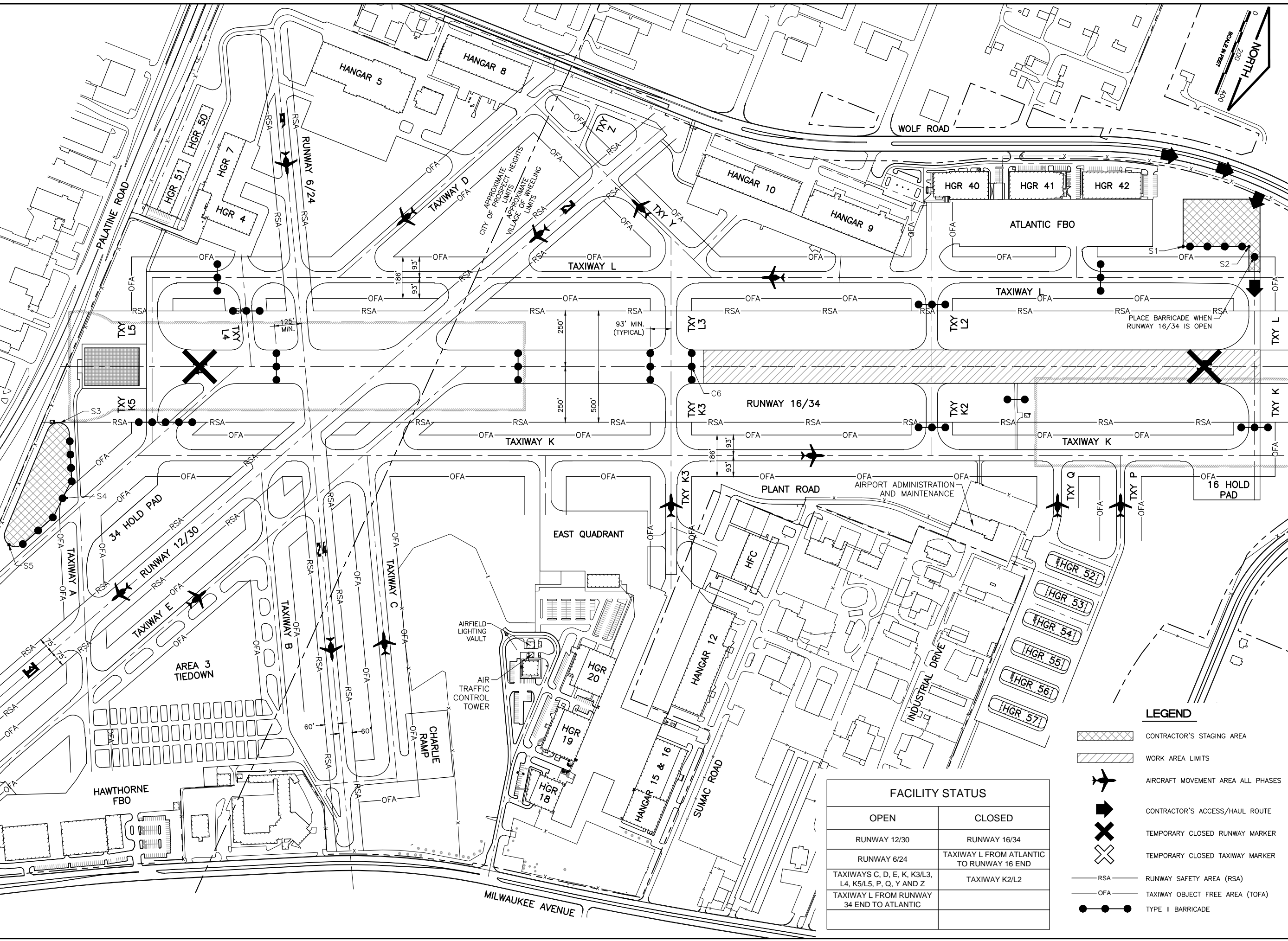

IL CONTRACT: **PA059**
 IL LETTING ITEM: **18A**
 IL PROJECT: **PWK-4414**
 S.B.G. PROJECT: **3-17-SBGP-XX**

SURVEY BOOK # 1302

REVISIONS		
NUMBER	BY	DATE

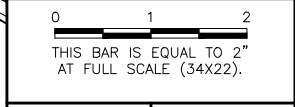

CHICAGO EXECUTIVE AIRPORT
WHEELING/PROSPECT HEIGHTS, ILLINOIS
REHABILITATE RUNWAY 16/34
SEQUENCE OF CONSTRUCTION
PHASE 4

FACILITY STATUS	
OPEN	CLOSED
RUNWAY 12/30	RUNWAY 16/34
RUNWAY 6/24	TAXIWAY L FROM ATLANTIC TO RUNWAY 16 END
TAXIWAYS C, D, E, K, K3/L3, L4, K5/L5, P, Q, Y AND Z	TAXIWAY K2/L2
TAXIWAY L FROM RUNWAY 34 END TO ATLANTIC	

- LEGEND**
- CONTRACTOR'S STAGING AREA
 - WORK AREA LIMITS
 - AIRCRAFT MOVEMENT AREA ALL PHASES
 - CONTRACTOR'S ACCESS/HAUL ROUTE
 - TEMPORARY CLOSED RUNWAY MARKER
 - TEMPORARY CLOSED TAXIWAY MARKER
 - RSA
 - TOFA
 - TYPE II BARRICADE

© Copyright CMT, Inc.

CMT
 CRAWFORD, MURPHY & TILLY, INC.
 CONSULTING ENGINEERS
 License No. 184-000613

CHICAGO EXECUTIVE AIRPORT

DESIGN BY:	SMS
DRAWN BY:	JRO
CHECKED BY:	SMS
APPROVED BY:	DKP
DATE:	06/19/2015
JOB No:	14290-05-00

FINAL

SHEET 07 OF 58 SHEETS

DATE: Thursday, July 9, 2015, 09:25:59
 FILE: K:\Chicago\esha\14290-05-Relief\16-34\Draw\Sheet\08_SEQUENCE 5.dwg
 UPDATE BY: Sean Smith
 LAYOUT: 07_SEQUENCE 4
 IMAGE FILES: pmknewLOGO_CEA-4_Color_Smol (2).jpg
 KREF DWG: bchrt1_ranroy.dwg
 Runway 16-34 Base-NEW.dwg

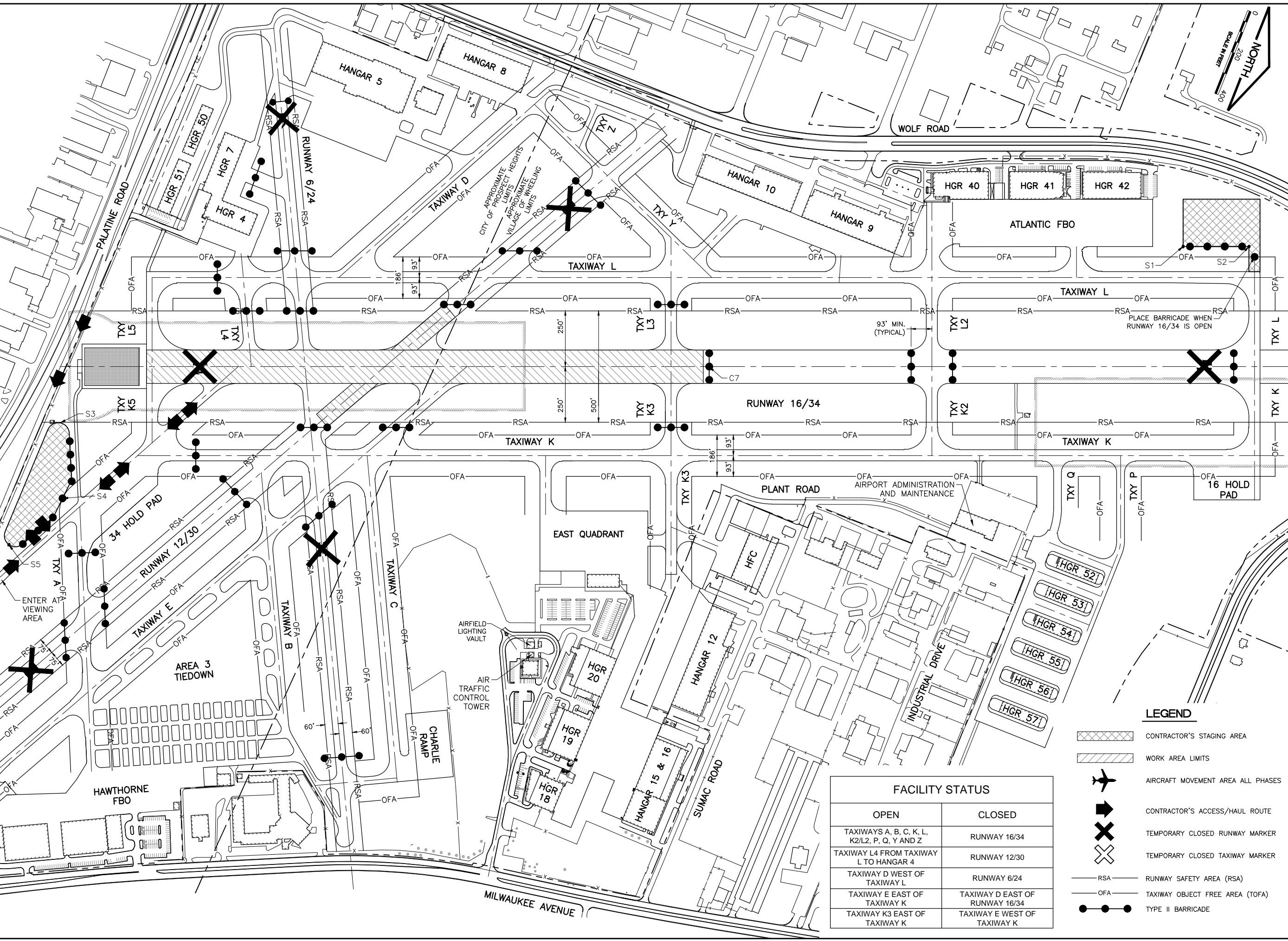

IL CONTRACT: PA059
 IL LETTING ITEM: 18A
 IL PROJECT: PWK-4414
 S.B.G. PROJECT: 3-17-SBGP-XX
 SURVEY BOOK # 1302

REVISIONS		
NUMBER	BY	DATE

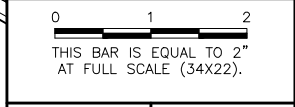

CHICAGO EXECUTIVE AIRPORT
WHEELING/PROSPECT HEIGHTS, ILLINOIS
REHABILITATE RUNWAY 16/34
SEQUENCE OF CONSTRUCTION
PHASE 5

© Copyright CMT, Inc.
CMT
 CRAWFORD, MURPHY & TILLY, INC.
 CONSULTING ENGINEERS
 License No. 184-000613
CHICAGO EXECUTIVE AIRPORT

DESIGN BY:	SMS
DRAWN BY:	JRO
CHECKED BY:	SMS
APPROVED BY:	DKP
DATE:	06/19/2015
JOB No:	14290-05-00

FINAL
 SHEET 08 OF 58 SHEETS

FACILITY STATUS	
OPEN	CLOSED
TAXIWAYS A, B, C, K, L, K2/L2, P, Q, Y AND Z	RUNWAY 16/34
TAXIWAY L4 FROM TAXIWAY L TO HANGAR 4	RUNWAY 12/30
TAXIWAY D WEST OF TAXIWAY L	RUNWAY 6/24
TAXIWAY E EAST OF TAXIWAY K	TAXIWAY D EAST OF RUNWAY 16/34
TAXIWAY K3 EAST OF TAXIWAY K	TAXIWAY E WEST OF TAXIWAY K

- LEGEND**
- CONTRACTOR'S STAGING AREA
 - WORK AREA LIMITS
 - AIRCRAFT MOVEMENT AREA ALL PHASES
 - CONTRACTOR'S ACCESS/HAUL ROUTE
 - TEMPORARY CLOSED RUNWAY MARKER
 - TEMPORARY CLOSED TAXIWAY MARKER
 - RSA
 - TOFA
 - TYPE II BARRICADE

XREF DWG: bchml_rumway.dwg

IMAGE FILES: pmknewLOGO_CEA-4-Color-Small (2).jpg

UPDATE BY: Sean Smith
LAYOUT: 60 SEC NOTION

DATE: Thursday, July 9, 2015 09:26:15
FILE: K:\Chicago\ref\14290-05_Retab\RWY16-34\Draw\Sheets\09_SEQUENCE NOTES_1.dwg

GENERAL NOTES

1. THE SUGGESTED SEQUENCE OF CONSTRUCTION SHOWN IS INTENDED TO ALLOW FOR THE ORDERLY CONSTRUCTION OF THE PROPOSED IMPROVEMENTS WHILE MAINTAINING AIRCRAFT ACCESS AT ALL TIMES. THE PHASING SHOWN IS A SUGGESTED SEQUENCE OF CONSTRUCTION ONLY. THIS SEQUENCE MAY BE MODIFIED HOWEVER, ALTERNATE STAGING PLANS MUST MAINTAIN AIRPORT OPERATIONS TO THE SATISFACTION OF THE AIRPORT MANAGER AND RESIDENT ENGINEER AND BE APPROVED BY THE DIVISION OF AERONAUTICS AND FEDERAL AVIATION ADMINISTRATION.
2. ALL OPERATIONS SHALL BE IN CONFORMANCE WITH AC 150/5370-2F (LATEST EDITION) "OPERATIONAL SAFETY ON AIRPORTS DURING CONSTRUCTION".
3. CONTRACTOR'S EQUIPMENT SHALL BE STORED IN THE EQUIPMENT AND MATERIAL STORAGE/STAGING AREA WHEN CONSTRUCTION IS NOT IN PROGRESS. NO EXCEPTIONS FOR SLOW MOVING EQUIPMENT SHALL BE ALLOWED
4. THE AIRPORT MANAGER SHALL HAVE FINAL SAY IN THE APPROVAL OF THE CONSTRUCTION OPERATING PHASING AND SEQUENCE AS IT RELATES TO PEDESTRIAN, VEHICULAR AND AIRCRAFT SAFETY.
5. ALL EXISTING PAVEMENTS, DRIVES OR ANY OTHER AREAS USED AS A HAUL ROAD OR STORAGE AREA BY THE CONTRACTOR SHALL BE RESTORED IN KIND TO THEIR PRE-CONSTRUCTION CONDITION OR TO THE SATISFACTION OF THE RESIDENT ENGINEER AND AIRPORT MANAGER. THE COST OF MAINTAINING, REPAIRING OR CONSTRUCTING THESE PAVEMENTS AND AREAS SHALL BE INCIDENTAL TO THE CONTRACT. EXISTING AREAS OUTSIDE THE PROJECT LIMITS WHICH ARE DISTURBED BY THE CONTRACTOR'S OPERATIONS SHALL BE RESTORED BY HIM AT HIS EXPENSE TO THE SATISFACTION OF THE RESIDENT ENGINEER AND THE AIRPORT MANAGER.
6. THE CONTRACTOR SHALL KEEP ALL TRUCKS, EQUIPMENT AND MATERIALS OFF OF THE EXISTING TAXIWAYS, APRONS AND RUNWAYS OUTSIDE OF THE PROJECT LIMITS EXCEPT AS SHOWN OR WITH THE PRIOR PERMISSION OF THE ENGINEER AND AIRPORT.
7. WORK PERFORMED BY THE CONTRACTOR OUTSIDE OF DAYLIGHT HOURS SHALL BE DONE UNDER SUFFICIENT ARTIFICIAL LIGHTING TO ALLOW FOR PROPER CONSTRUCTION METHODS AND INSPECTIONS. LIGHT SHALL CONSIST OF MOVABLE POLE MOUNTED FLOODLIGHTS AND/OR SPOTLIGHTS OF SUFFICIENT NUMBER TO ILLUMINATE THE WORK AREA. VEHICLE HEADLIGHTS WILL BE ALLOWED ONLY IN ADDITION TO OTHER LIGHTS MENTIONED ABOVE. LIGHTING SHALL BE AS APPROVED BY THE ENGINEER AND SHALL NOT BE USED IF THEY AFFECT FLIGHT SAFETY. CONTRACTOR'S WORK HOURS SHALL BE IN ACCORDANCE WITH LOCAL ORDINANCES.
8. THE CONTRACTOR SHALL PROVIDE PORTABLE FLOOD LIGHTING FOR NIGHTTIME CONSTRUCTION. SUFFICIENT UNITS SHALL BE PROVIDED SO THAT WORK AREAS ARE ILLUMINATED TO A LEVEL OF FIVE HORIZONTAL FOOT CANDLES. THE LIGHTING LEVELS SHALL BE CALCULATED AND MEASURED IN ACCORDANCE WITH THE CURRENT STANDARDS OF THE ILLUMINATION ENGINEERING SOCIETY. LIGHTS SHALL BE POSITIONED SO AS NOT TO INTERFERE WITH AIRPORT OPERATIONS.
9. THE CONTRACTOR WILL BE REQUIRED TO HAVE A SWEEPER AVAILABLE FOR USE AT ALL TIMES. WHEN ACTIVE AIRFIELD PAVEMENTS ARE UTILIZED AS HAUL ROADS BY THE CONTRACTOR, MATERIAL TRACKED ON TO THE PAVEMENT SHALL BE CONTINUALLY REMOVED WITH SAID SWEEPER. THIS SWEEPING SHALL NOT BE PAID FOR SEPARATELY BUT SHALL BE CONSIDERED INCIDENTAL TO THE CONTRACT.
10. MATERIALS REMOVED FROM THE PROJECT WILL BECOME PROPERTY OF THE CONTRACTOR AND SHALL BE DISPOSED OF OFF AIRPORT PROPERTY, UNLESS NOTED OTHERWISE.
11. PAYMENT FOR TRAFFIC CONTROL INCLUDING, BUT NOT LIMITED TO BARRICADES, CONSTRUCTION FENCE, SIGNING, RUNWAY AND TAXIWAY CLOSED MARKERS, SAFETY AND OBJECT FREE AREAS, LATHE AND RIBBON, ETC. SHALL NOT BE PAID SEPARATELY, BUT SHALL BE CONSIDERED INCIDENTAL TO THE CONTRACT. LOW PROFILE BARRICADES END TO END AND IDOT TYPE II BARRICADES AT 10-FOOT CENTERS WITH TWO ORANGE FLAGS (20" x 20") BETWEEN EACH SET OF BARRICADES OR 4' HIGH ORANGE CONSTRUCTION FENCE SECURELY ATTACHED TO EACH BARRICADE SHALL BE PLACED AT THE LOCATIONS SHOWN ON THE PLANS OR AS DIRECTED BY THE ENGINEER. BARRICADES SHALL BE WEIGHTED TO PREVENT BLOWING OVER. BARRICADES SHALL HAVE FLASHING RED LIGHT(S) AND CONFORM TO IDOT STANDARD 701901-02. TYPE II AND LOW PROFILE BARRICADES SHALL CONFORM TO THE DETAILS IN THE PLANS AND SEQUENCE OF CONSTRUCTION. BARRICADE INSTALLATION WILL BE REQUIRED PRIOR TO ACCESS TO THE WORK AREA BY CONTRACTOR'S WORKERS, EQUIPMENT OR MATERIAL. SIGNS SHALL BE PLACED AT EACH TAXIWAY/RUNWAY CLOSURE LOCATION AND SHALL BE ATTACHED TO THE BARRICADES. EACH BARRICADE LOCATION SHALL CONSIST OF ONE "DO NOT ENTER" SIGN AND ONE "AIRCRAFT MOVEMENT AREA" SIGN. SIGNS SHALL BE CONSIDERED INCIDENTAL TO THE CONTRACT. ALL BARRICADES SHALL BE PLACED OUTSIDE OF ACTIVE SAFETY AREAS AND OBJECT FREE AREAS.
12. THE CONTRACTOR SHALL CONTACT THE AIRPORT MANAGER THROUGH THE RESIDENT ENGINEER TEN (10) WORKING DAYS IN ADVANCE OF THE START OF CONSTRUCTION SO THAT THE APPROPRIATE NOTAMS MAY BE ISSUED.
13. THE CONTRACTOR SHALL BE RESPONSIBLE FOR KEEPING ALL CONSTRUCTION ACCESS GATES CLOSED DURING NON WORKING HOURS. THE CONTRACTOR SHALL PROVIDE A SIGN AT THE ACCESS GATE SAYING "AUTHORIZED PERSONNEL ONLY". THE CONTRACTOR SHALL CLOSE AND LOCK THE ACCESS GATE UPON LEAVING THE SITE. THROUGHOUT THE DURATION OF THE CONTRACT, ANY DAMAGES TO THE ACCESS ROAD, ACCESS GATE OR FENCING ADJACENT TO THE PROJECT SHALL BE REPAIRED BY THE CONTRACTOR TO THE SATISFACTION OF THE RESIDENT ENGINEER. ALL COST RELATING TO CONTRACTOR'S ACCESS AND SECURITY SHALL BE THE RESPONSIBILITY OF THE CONTRACTOR.
14. CONTRACTOR WILL BE REQUIRED TO PUT AIRPORT FLAGS OR A WORKING BEACON LIGHT ON ALL EQUIPMENT AT ALL TIMES DURING CONSTRUCTION. SEE FLAG DETAIL.
15. IN THE CASE OF AN EMERGENCY, CONTRACTOR SHALL NOTIFY AIRPORT MANAGER AND THE RESIDENT ENGINEER IMMEDIATELY.
16. DURING ADVERSE WEATHER, THE CONTRACTOR SHALL MAKE PROVISIONS FOR ACCESS TO THE WORK AT NO ADDITIONAL COST TO THE CONTRACT. NO EXTENSION OF CONTRACT TIME WILL BE CONSIDERED FOR DELAYS DUE TO LACK OF ADEQUATE ACCESS TO THE WORK.
17. THE TALLEST PIECE OF CONSTRUCTION EQUIPMENT IS ANTICIPATED TO BE AN ASPHALT/STONE TRUCK WHICH HAS A MAXIMUM HEIGHT OF 25 FEET IN A DUMP POSITION.
18. IF RUNWAY NUMERALS ARE PRESENT DURING CONSTRUCTION THEN CONTRACTOR SHALL PLACE CLOSED RUNWAY MARKER OVER NUMERALS AS DETAILED, OTHERWISE PLACE RUNWAY CLOSED MARKER IN TURF AT ENDS OF RUNWAY AS DETAILED.
19. CHICAGO EXECUTIVE AIRPORT WILL BE IN OPERATION DURING THE CONSTRUCTION OF THIS PROJECT. COORDINATION OF WORK WITH THE AIRPORT IS MANDATORY SO AS TO MINIMIZE IMPACTS ON AIRPORT OPERATIONS.
20. APPROXIMATE LOCATION OF HAUL ROUTES ON THE AIRPORT SITE ARE SHOWN ON THE GENERAL PROJECT LAYOUT AND THE PHASING PLANS. IT SHALL BE THE CONTRACTOR'S RESPONSIBILITY TO COORDINATE OFF-SITE HAUL ROUTES (STATE HIGHWAYS, COUNTY ROADS OR CITY STREETS) WITH THE APPROPRIATE OWNER WHO HAS JURISDICTION OVER THE AFFECTED ROUTE. ON-SITE ROADS USED AS HAUL ROUTES SHALL BE MAINTAINED BY THE CONTRACTOR AND SHALL BE RESTORED AT THE CONTRACTOR'S EXPENSE TO THEIR ORIGINAL CONDITION UPON COMPLETION OF BEING USED AS A HAUL ROUTE. THE BEFORE AND AFTER CONDITION OF ON-SITE HAUL ROUTES SHALL BE JOINTLY INSPECTED AND DETERMINED BY THE CONTRACTOR AND THE ENGINEER. FENCING, DRAINAGE, GRADING AND OTHER MISCELLANEOUS CONSTRUCTION REQUIRED TO CONSTRUCT TEMPORARY HAUL ROUTES OR ACCESS POINTS ON THE AIRPORT WILL BE THE CONTRACTOR'S TOTAL RESPONSIBILITY AND SHALL BE APPROVED BY THE ENGINEER PRIOR TO THE WORK. ALL ON-SITE ACCESS ROADS TO AIRPORT FACILITIES SHALL REMAIN OPEN AND MAINTAINED AT ALL TIMES.
21. MOBILIZATION/EQUIPMENT STORAGE AREA WILL BE MADE AVAILABLE FOR CONTRACTOR'S MOBILIZATION AND STORAGE AS SHOWN ON THE PLANS. THIS AREA SHALL BE RESTORED TO THE ORIGINAL CONDITION UPON COMPLETION OF THE PROJECT AT THE CONTRACTOR'S EXPENSE.

22. LOCATION OF KNOWN EXISTING AIRPORT UNDERGROUND CABLES ARE SHOWN ON THE PLANS AND MUST BE VERIFIED BY THE CONTRACTOR. REPAIR OF DAMAGED CABLE MUST BE STARTED IMMEDIATELY AND CONTINUED UNTIL COMPLETED. ALL SUCH REPAIRS SHALL BE IN ACCORDANCE WITH THE SPECIFICATIONS, OR AS DIRECTED BY THE OWNER OF THE CABLE OR FACILITY, AND SHALL BE AT THE CONTRACTOR'S EXPENSE. IF FAA CABLES ARE DAMAGED, REPAIRS SHALL BE DONE FROM PREVIOUS EXISTING TERMINATION POINT TO PREVIOUS EXISTING TERMINATION POINT IN ACCORDANCE WITH FAA REQUIREMENTS AND IN THE PRESENCE OF A FAA REPRESENTATIVE. THE OWNER MAY ELECT TO HAVE THE REPAIR PERFORMED BY OTHERS IN WHICH CASE THE CONTRACTOR SHALL BE RESPONSIBLE FOR PAYING THE INCURRED COSTS OF REPAIRS.
23. COORDINATION MEETINGS - THE CONTRACTOR SHALL CONDUCT WEEKLY COORDINATION MEETINGS TO DISCUSS WORK AREAS AND SCHEDULING, ETC. WITH THE ENGINEER, AIRPORT OPERATIONS, FAA, AND OTHER APPROPRIATE OFFICIALS. MINUTES FROM THE WEEKLY MEETINGS SHALL BE PREPARED BY THE CONTRACTOR, FURNISHED TO ALL ATTENDEES PRIOR TO THE SUBSEQUENT MEETING, AND KEPT ON FILE AT THE FIELD OFFICE. THE COORDINATION MEETING COSTS SHALL BE CONSIDERED INCIDENTAL TO THE PROJECT.
24. THE CONTRACTOR SHALL PROVIDE THE PHONE NUMBERS OF THREE PERSONNEL, INCLUDING THE PROJECT SUPERINTENDENT, WHO MAY BE CONTACTED IN AN EMERGENCY. PERSONNEL SHALL BE ON CALL 24 HOURS PER DAY FOR MAINTAINING AIRPORT HAZARD LIGHTING AND BARRICADES.
25. DRAINAGE MODIFICATIONS SHALL BE SEQUENCED TO PROVIDE POSITIVE DRAINAGE AT ALL TIMES AT NO ADDITIONAL COST TO THE CONTRACT.
26. VEHICLES AND EQUIPMENT SHALL NOT BE ALLOWED WITHIN THE TAXIWAY OBJECT FREE AREA AND RUNWAY SAFETY AREA OF ACTIVE TAXIWAYS AND RUNWAYS.
27. CONTRACTOR SHALL STORE EQUIPMENT AND MATERIALS IN SUCH A MANNER AS NOT TO VIOLATE FEDERAL AVIATION ADMINISTRATION PART 77 IMAGINARY SURFACES OR RUNWAY AND TAXIWAY SAFETY AREAS.
28. ALL EXISTING TAXIWAY AND RUNWAY AIRFIELD LIGHTING CIRCUITS, FAA CABLES AND OTHER ELECTRICAL CABLES SHALL REMAIN IN SERVICE AT ALL TIMES. ALL EXISTING LIGHTING AND VAULT EQUIPMENT SHALL REMAIN IN SERVICE UNTIL PROPOSED IMPROVEMENTS ARE INSTALLED AND OPERATIONAL, UNLESS OTHERWISE APPROVED BY THE ENGINEER. ANY CABLES DAMAGED BY THE CONTRACTOR SHALL BE IMMEDIATELY REPAIRED AT HIS EXPENSE. ANY NECESSARY TEMPORARY JUMPER CABLES SHALL BE CONSIDERED INCIDENTAL TO THE CONTRACT.
29. COORDINATION BY THE CONTRACTOR WITH THE EXISTING UTILITIES SHALL BE COMPLETED BEFORE CONSTRUCTION IS STARTED. CONTRACTOR IS REFERRED TO SECTION 50-17 OF THE SPECIAL PROVISIONS FOR SPECIFIC REQUIREMENTS. THE LOCATION OF UNDERGROUND UTILITIES AS INDICATED ON THE PLANS HAS BEEN OBTAINED FROM EXISTING RECORDS. NEITHER THE OWNER OR THE DESIGN ENGINEER ASSUME ANY RESPONSIBILITY WHATSOEVER IN RESPECT TO THE ACCURACY, COMPLETENESS OR SUFFICIENCY OF THE INFORMATION. THERE IS NO GUARANTEE, EITHER EXPRESSED OR IMPLIED THAT THE LOCATIONS, SIZE AND TYPE MATERIAL OF EXISTING UNDERGROUND UTILITIES AS INDICATED ARE REPRESENTATIVE OF THOSE TO BE ENCOUNTERED DURING CONSTRUCTION. IT SHALL BE THE CONTRACTOR'S RESPONSIBILITY TO DETERMINE THE ACTUAL LOCATION OF ALL SUCH FACILITIES, INCLUDING SERVICE CONNECTIONS TO UNDERGROUND UTILITIES. PRIOR TO CONSTRUCTION, THE CONTRACTOR SHALL NOTIFY THE UTILITY COMPANY OF HIS OPERATIONAL PLANS. THE CONTRACTOR SHALL MAKE ARRANGEMENTS FOR DETAILED INFORMATION AND ASSISTANCE IN LOCATING UTILITIES. IN THE EVENT AN UNEXPECTED UTILITY INTERFERENCE IS ENCOUNTERED DURING CONSTRUCTION, THE CONTRACTOR SHALL IMMEDIATELY NOTIFY THE UTILITY COMPANY, THE RESIDENT ENGINEER AND THE AIRPORT MANAGER. ANY SUCH MAINS AND/OR SERVICES DISTURBED BY THE CONTRACTOR'S OPERATIONS SHALL BE RESTORED IMMEDIATELY AT HIS EXPENSE TO THE SATISFACTION OF THE RESIDENT ENGINEER AND AIRPORT MANAGER.
30. ALL AIRFIELD LIGHTING AND LIGHTING GUIDANCE SYSTEMS (NAVAIDS) LOCATED WITHIN AND IMMEDIATELY ADJACENT TO THE CONTRACTORS WORK ZONE SHALL BE CHECKED FOR OPERATIONAL CONDITION PRIOR TO THE DEPARTURE FROM THE AIRPORT WITH THE AIRPORT MANAGER. ANY DEFICIENCIES IN THESE SYSTEMS DUE TO THE ACTS OF CONTRACTOR OR HIS SUBCONTRACTORS, SUPPLIERS OR CONSULTANTS SHALL BE REPAIRED IMMEDIATELY.

CONTRACTOR CROSSING RUNWAY SAFETY AREAS (RSA) AND TAXIWAY OBJECT FREE AREAS (TOFA)

31. ANYTIME THE CONTRACTOR IS REQUIRED TO UTILIZE OR CROSS ACTIVE AIRFIELD PAVEMENTS FOR ACCESS TO AND FROM THE WORK ZONE, A FULL TIME CROSSING GUARD IN RADIO CONTACT WITH THE CONTROL TOWER SHALL BE FURNISHED BY THE CONTRACTOR FOR MOVEMENTS OF VEHICLES OR EQUIPMENT TO AND FROM THE WORK ZONE. THE RADIO OPERATOR SHALL BE FAMILIAR WITH AIRPORT GROUND CONTROL PROCEDURES AND DEMONSTRATE KNOWLEDGE OF SAME TO THE AIRPORT. THE AIRPORT RESERVES THE RIGHT TO APPROVE THE CROSSING GUARDS. THE CONTRACTOR SHALL PROVIDE THEIR OWN RADIOS. THIS COST SHALL BE CONSIDERED INCIDENTAL TO THE CONTRACT. THE CONTRACTOR SHALL BE RESPONSIBLE FOR PAYMENT OF MUNICIPAL FINES (\$500 PER OCCURRENCE) DUE TO AIRFIELD INCURSIONS BY HIS EMPLOYEES, SUBCONTRACTORS, SUPPLIERS, CONSULTANTS AND/OR AGENTS.
32. ANY PAVEMENT DAMAGED BY CONTRACTOR'S OPERATIONS SHALL BE REPAIRED IMMEDIATELY BY HIM TO THE SATISFACTION OF THE RESIDENT ENGINEER AND AIRPORT MANAGER AT NO ADDITIONAL COST TO THE OWNER. PAVEMENT SHALL BE CONTINUALLY SWEEPED TO PROVIDE DEBRIS FREE SURFACE DURING ALL HAUL ROAD OPERATIONS. THIS COST SHALL NOT BE PAID SEPARATELY BUT SHALL BE CONSIDERED INCIDENTAL TO THE CONTRACT.

LIMITATIONS ON CONSTRUCTION WITHIN RUNWAY SAFETY AREAS (RSA) AND TAXIWAY OBJECT FREE AREAS (TOFA)

RUNWAYS:

33. THE CONTRACTOR SHALL NOTIFY THE RESIDENT ENGINEER AND AIRPORT MANAGER TEN (10) WORKING DAYS IN ADVANCE OF ANY PLANNED CONSTRUCTION WITHIN THESE LIMITS. ANY WORK WITHIN THE RUNWAY SAFETY AREA WILL REQUIRE A RUNWAY CLOSURE. WORK SHALL BE EXPEDITED IN THESE AREAS AND AT THE END OF EACH WORKING PERIOD THESE AREAS SHALL BE SMOOTHLY GRADED TO ALLOW THE RUNWAY TO BE REOPENED PER FAA REQUIREMENTS. AT LEAST ONE OF THE RUNWAYS SHALL REMAIN IN OPERATION AT ALL TIMES. IF NECESSARY, STEEL PLATES SHALL BE FURNISHED AND INSTALLED BY THE CONTRACTOR TO COVER ANY OPEN TRENCHES OR EXCAVATION WITHIN THE RSA AT NO ADDITIONAL COST TO THE CONTRACT. NO MATERIAL SHALL BE STOCKPILED WITHIN THE RSA. IF DURING RUNWAY CLOSURE AN EMERGENCY IS DECLARED, THE CONTRACTOR SHALL IMMEDIATELY CLEAR THE RUNWAY OF ALL VEHICLES, MEN, EQUIPMENT AND BARRICADES.

TAXIWAYS:

34. THE CONTRACTOR SHALL NOTIFY THE RESIDENT ENGINEER AND AIRPORT MANAGER FIVE (5) WORKING DAYS IN ADVANCE FOR WORK WITHIN THE TAXIWAY OBJECT FREE AREA. ANY WORK WITHIN THE TAXIWAY OBJECT FREE AREA WILL REQUIRE A TAXIWAY CLOSURE. WORK WITHIN THE TAXIWAY OBJECT FREE AREA SHALL BE EXPEDITED AND AT THE END OF EACH WORKING PERIOD THESE AREAS SHALL BE SMOOTHLY GRADED TO ALLOW THE TAXIWAY TO BE REOPENED PER FAA REQUIREMENTS. IF NECESSARY, STEEL PLATES SHALL BE FURNISHED AND INSTALLED BY THE CONTRACTOR TO COVER ANY OPEN TRENCHES OR EXCAVATION WITHIN THE TOFA AT NO ADDITIONAL COST TO THE CONTRACT. NO MATERIAL OR EQUIPMENT SHALL BE STOCKPILED OR STORED WITHIN THE TOFA. SHOULD IT BE NECESSARY FOR THE CONTRACTOR TO TEMPORARILY RELOCATE EQUIPMENT TO ALLOW AIRCRAFT TO PASS, THEY SHALL DO SO AT NO EXTRA COST TO THE PROJECT.

**DESIGN AIRCRAFT APPROACH CATEGORY: D
DESIGN AIRPORT GROUP: III**

REHABILITATE RUNWAY 16/34
MAXIMUM ANTICIPATED WINGSPAN OF ADG III
GULFSTREAM G500 - WINGSPAN = 93.5'

CONTRACTOR SHALL PLAN AND PERFORM HIS WORK SO AS NOT TO INTERFERE OR HINDER THE PROGRESS, WORK OR HAUL ROAD ACCESS OF OTHER CONTRACTORS (SEE SPECIAL PROVISIONS SECTION 30-05). THE PRIME CONTRACTOR WILL BE RESPONSIBLE TO COORDINATE CONSTRUCTION ACTIVITIES AND ACCESS BETWEEN ALL ON-SITE CONTRACTORS SUBCONTRACTORS. IT IS ANTICIPATED THE FOLLOWING PROJECTS MAY BE UNDER CONSTRUCTION CONCURRENTLY WITH THIS PROJECT. NO ADDITIONAL COMPENSATION SHALL BE CONSIDERED FOR ANY EFFORTS TO COORDINATE AND ACCESS THE TAXIWAY SITE DUE TO ADJACENT BUILDING CONSTRUCTION

- CONSTRUCTION OF BYPASS TAXIWAY IN NW QUADRANT
- REHABILITATION OF EAST QUADRANT APRON IN EAST QUADRANT
- EAST QUADRANT HANGAR AND APRON DEVELOPMENT IN EAST QUADRANT

GROUND CONTROL FREQUENCY: 121.7 MHz
AIR CONTROL FREQUENCY: 119.9 MHz

MAXIMUM ANTICIPATED HEIGHT OF CONSTRUCTION EQUIPMENT: DUMP TRUCK IN DUMP POSITION - 25'

IN THE EVENT THE CONTRACTOR PROPOSES TO UTILIZE CONSTRUCTION EQUIPMENT THAT IS TALLER THAN WHAT IS LISTED, THE CONTRACTOR WILL BE RESPONSIBLE TO SUBMIT FAA FORM 7460 FOR AIRSPACE APPROVAL. THE RESIDENT ENGINEER WILL PROVIDE BASE AIRPORT INFORMATION FOR THE CONTRACTOR'S USE.

TABLE 1 - CRITICAL POINTS

WORK AREA	POINT	APPROXIMATE ELEVATION OF GROUND (1929 DATUM)	ANTICIPATED EQUIPMENT AND HEIGHT	APPROXIMATE ELEVATION OF EQUIPMENT (1929 DATUM)	LATITUDE (NAD 83)	LONGITUDE (NAD 83)
1	C1	644	SEMI/DUMP TRUCK - 25'	669	42°06'51.69"	87°54'08.66"
2	C2	642	SEMI/DUMP TRUCK - 25'	667	42°06'58.80"	87°54'12.40"
2	C3	645	SEMI/DUMP TRUCK - 25'	670	42°06'43.64"	87°54'04.43"
3	C4	642	SEMI/DUMP TRUCK - 25'	667	42°06'43.92"	87°54'04.58"
3	C5	642	SEMI/DUMP TRUCK - 25'	667	42°06'41.21"	87°54'06.71"
4	C6	642	GROOVING MACHINE - 25'	667	42°07'00.51"	87°54'13.30"
5	C7	642	GROOVING MACHINE - 25'	667	42°07'01.23"	87°54'13.68"
STAGING	S1	642	PICK UP TRUCK - 10'	652	42°07'18.86"	87°54'30.65"
STAGING	S2	642	PICK UP TRUCK - 10'	652	42°07'21.58"	87°54'32.08"
STAGING	S3	642	PICK UP TRUCK - 10'	652	42°06'35.33"	87°53'56.45"
STAGING	S4	641	PICK UP TRUCK - 10'	651	42°06'36.65"	87°53'52.31"
STAGING	S5	640	PICK UP TRUCK - 10'	650	42°06'35.19"	87°53'48.58"

EXISTING CRITICAL AIRCRAFT AND REQUIRED SAFETY AREAS

RUNWAY	16/34	12/30	6/24
APPROACH CATEGORY	D	B	B
DESIGN GROUP	III	II	I
DESIGN AIRCRAFT	GULFSTREAM 550	KING AIR B200	CESSNA 421
APPROACH SPEED	141 KNOTS	103 KNOTS	96 KNOTS
WINGSPAN	94 FEET	55 FEET	42 FEET
TAIL HEIGHT	25.8 FEET	15.0 FEET	11.6 FEET
STRENGTH (MGTW)	90,500 LBS.	12,500 LBS.	7,450 LBS.
LENGTH	97 FEET	44 FEET	37 FEET
RUNWAY SAFETY AREA WIDTH (RSA)	500 (250' FROM \varnothing)	150 (75' FROM \varnothing)	120 (60' FROM \varnothing)
(1)(3) RWY OBJECT FREE AREA WIDTH (ROFA)	800	500	400
TAXIWAY SAFETY AREA WIDTH (TSA)	118	79	49
(1)(3) TXY OBJECT FREE AREA WIDTH (TOFA)	186 (93' FROM \varnothing)	131 (65.5' FROM \varnothing)	89 (44.5' FRM \varnothing)

DATA FROM 2009 CEA APPROVED ALP

1. TOFA, ROFA, RSA, CRITICAL AREAS, PART 77 AND DEPARTURE/APPROACH SURFACES ARE SHOWN FOR RUNWAY 16/34 WHICH SHALL BE CLOSED DURING THE CONSTRUCTION PHASE DURATION.
2. RUNWAY 16/34 END COORDINATES ARE NOT CHANGING IN THIS PROJECT.
3. NO CONSTRUCTION WITHIN THESE LIMITS WILL BE ALLOWED WITHOUT THE RUNWAY AND/OR TAXIWAY BEING CLOSED.
4. AT THE END OF THE WORK DAY NO CONSTRUCTION EQUIPMENT SHALL BE PARKED/STORED WITHIN THE OBJECT FREE AREA(S) OF OPEN OR CLOSED RUNWAYS AND/OR TAXIWAYS. PARKED/STORED EQUIPMENT HEIGHT SHALL NOT PENETRATE PART 77 SURFACE(S).

NOTES - ALL PHASES

1. ALL EXISTING TAXIWAY AND RUNWAY AIRFIELD LIGHTING CIRCUITS, FAA CABLES AND OTHER AIRPORT ELECTRICAL CABLES SHALL REMAIN IN SERVICE UNTIL REPLACED AS ACCEPTABLE TO THE RESIDENT ENGINEER. ALL TEMPORARY CABLING AND SPLICING NECESSARY TO KEEP THE CIRCUITS IN OPERATION SHALL BE CONSIDERED INCIDENTAL TO CONTRACT.
2. ALL TEMPORARY FENCING REQUIRED FOR CONTRACTOR ACCESS AND SECURITY SHALL BE 6' CHAIN LINK FENCING AS APPROVED BY THE AIRPORT AND SHALL BE CONSIDERED INCIDENTAL TO THE CONTRACT, UNLESS SPECIFICALLY CALLED OUT IN THE PLANS.
3. WHEN FAA CABLES ARE REQUIRED TO BE LOCATED, A 10 WORKING DAY ADVANCED NOTICE SHALL BE GIVEN TO THE FAA BEFORE ANY SUCH MARKINGS ARE REQUIRED. ONCE FAA MARKS THE CABLES, THE CONTRACTOR WILL BE REQUIRED TO SURVEY THE FAA UTILITIES SO THEY CAN BE REPLACED DURING CONSTRUCTION WITHOUT REMARKING BY THE FAA. THIS SHALL BE INCIDENTAL AND AT THE CONTRACTOR'S EXPENSE. THE FAA PERSONNEL ARE ONLY AVAILABLE FROM 9 AM TO 3 PM, MONDAY THROUGH FRIDAY WITH ADVANCED NOTICE.
4. SPECIAL ATTENTION IS NECESSARY WHEN WORKING NEAR FAA POWER AND CONTROL CABLES. ANY FAA UTILITY THAT IS DAMAGED OR CUT DURING CONSTRUCTION SHALL BE REPAIRED IMMEDIATELY. FAA REQUIRES THAT ANY DAMAGED CABLE BE REPLACED IN ITS ENTIRETY, FROM POWER/CONTROL SOURCE TO THE EQUIPMENT/SERVICE. SPLICES OF ANY KIND WILL NOT BE PERMITTED. EXPOSURES OF ANY FAA CABLES MUST BE DONE BY HAND DIGGING OR HYDRO-EXCAVATION. NO ADDITIONAL COMPENSATION WILL BE MADE FOR LOCATING, REPLACEMENT OR REPAIR OF FAA FACILITIES OR CABLES BUT, SHALL BE INCIDENTAL AND AT THE CONTRACTOR'S EXPENSE.
5. ACCESS TO THE STAGING AREAS WHEN RUNWAY 16/34 IS OPEN SHALL REQUIRE AIRPORT ESCORT. COORDINATE ACCESS THROUGH THE RESIDENT ENGINEER AND THE AIRPORT OPERATIONS COORDINATOR.

IL. CONTRACT: **PA059**

IL. LETTING ITEM: **18A**

IL. PROJECT: **PWK-4414**
S.B.G. PROJECT: **3-17-SBGP-XX**

SURVEY BOOK # 1302

REVISIONS

NUMBER	BY	DATE

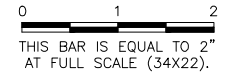

**CHICAGO EXECUTIVE AIRPORT
WHEELING/PROSPECT HEIGHTS, ILLINOIS
REHABILITATE RUNWAY 16/34**

**SEQUENCE OF CONSTRUCTION
GENERAL NOTES AND DETAILS 1**

© Copyright CMT, Inc.

CMT
CRAWFORD, MURPHY & TILLY, INC.
CONSULTING ENGINEERS
License No. 184-000613

CHICAGO EXECUTIVE AIRPORT

DESIGN BY: SMS

DRAWN BY: JRO

CHECKED BY: SMS

APPROVED BY: DKP

DATE: 06/19/2015

JOB No: 14290-05-00

FINAL

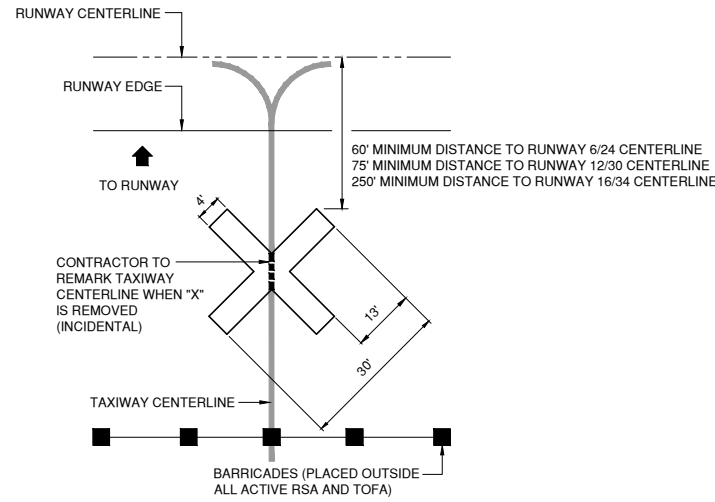

CLOSED TAXIWAY MARKER DETAIL
NOT TO SCALE

CLOSED TAXIWAY MARKER DETAIL NOTES

1. CLOSED TAXIWAY MARKERS SHALL BE PAINTED YELLOW WITH TEMPORARY MARKING CAPABLE OF BEING REMOVED WITH LOW PRESSURE WATER BLASTING OR OTHER MATERIAL THAT DOES NOT VIOLATE THE OBJECT FREE AREA CRITERIA AND RUNWAY SAFETY AREA CRITERIA PER ADVISORY CIRCULAR 150/5300-13A (LATEST EDITION) AND ARE APPROVED BY THE RESIDENT ENGINEER AND AIRPORT.
2. CONTRACTOR SHALL MAINTAIN AND RELOCATE MARKERS AS SHOWN ON THE PLANS OR AS NEEDED TO FACILITATE CONSTRUCTION
3. COST OF FURNISHING, INSTALLING, MAINTAINING AND REMOVING MARKERS SHALL BE CONSIDERED INCIDENTAL TO THE CONTRACT.
4. PLACE MARKERS OVER TAXIWAY CENTERLINE.
5. MARKERS SHALL BE ADEQUATELY SECURED TO PREVENT MOVEMENT BY PROPELLER WASH, JET BLAST OR OTHER WIND CURRENTS.
6. MARKERS ARE ONLY REQUIRED FOR CLOSURES EXCEEDING 72 HOURS.

CLOSED RUNWAY MARKER NOTES

1. DURING VARIOUS PHASES OF WORK, IT WILL BE NECESSARY TO CLOSE RUNWAYS TO AIR TRAFFIC ON A TEMPORARY BASIS AS COORDINATED WITH THE AIRPORT AND TOWER PERSONNEL.
2. FOR RUNWAY CLOSURES INVOLVING A SINGLE RUNWAY, IT IS ANTICIPATED THAT THE AIRPORT SHALL MOBILIZE THE AIRPORT OWNED LIGHTED "X'S ON EACH END OF THE CLOSED RUNWAY. THE CONTRACTOR SHALL BE REQUIRED TO MAINTAIN THE LIGHTED "X'S DURING EACH CLOSURE PERIOD. CONTRACTOR SUPPLIED MAINTENANCE SHALL INCLUDE, BUT NOT BE LIMITED TO, FUELING, REPLACING LAMPS, CHECKING AND SUPPLYING OIL, ETC. IF ANY DAMAGE IS INCURRED TO THE AIRPORT LIGHTED "X'S DURING CONSTRUCTION BY THE CONTRACTOR, THE CONTRACTOR SHALL REPLACE THE LIGHTED "X" IN KIND AT NO COST TO THE CONTRACT OR AIRPORT.
3. FOR RUNWAY CLOSURES INVOLVING MORE THAN ONE RUNWAY, OR IF THE AIRPORT OWNED LIGHTED "X'S ARE NOT AVAILABLE, THE CONTRACTOR SHALL MARK THE RUNWAYS TO BE CLOSED BY PLACING YELLOW CROSSES AT THE LOCATION AND DIMENSIONS DETAILED ON THE SEQUENCE OF CONSTRUCTION AND PER AC 150/5370-2F (LATEST EDITION). THE CROSSES ARE SHOWN ON THE RESPECTIVE RUNWAYS ACCORDING TO THE VARIOUS PHASES OF WORK AS DELINEATED IN THE SUGGESTED SEQUENCE OF CONSTRUCTION.
4. TEMPORARY CLOSED RUNWAY MARKERS SHALL BE YELLOW.
5. TEMPORARY MARKERS SHALL BE MATERIAL APPROVED BY THE ENGINEER.
6. CONTRACTOR SHALL MAINTAIN AND RELOCATE MARKERS AS SHOWN ON THE PLANS OR AS NEEDED TO FACILITATE CONSTRUCTION.
7. MARKERS ON PAVEMENT SHALL BE PLACED OVER EXISTING RUNWAY NUMERALS AS SHOWN.
8. COST OF FURNISHING, INSTALLING, MAINTAINING AND REMOVING MARKERS SHALL BE CONSIDERED INCIDENTAL TO THE CONTRACT.

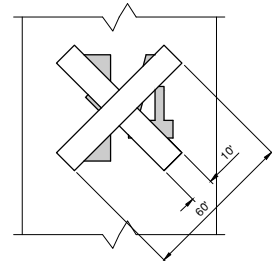

TEMPORARY CLOSED RUNWAY MARKER DETAIL
ON PAVEMENT - NO SCALE

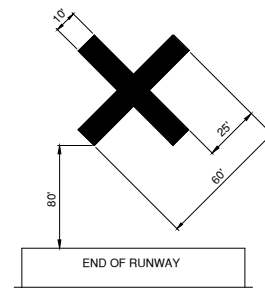

OFF PAVEMENT TEMPORARY CLOSED RUNWAY MARKER DETAIL
NO SCALE

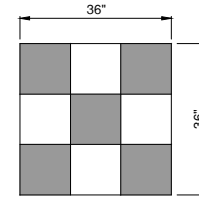

CONSTRUCTION EQUIPMENT AND TRUCK SIGNAL FLAG
NOT TO SCALE

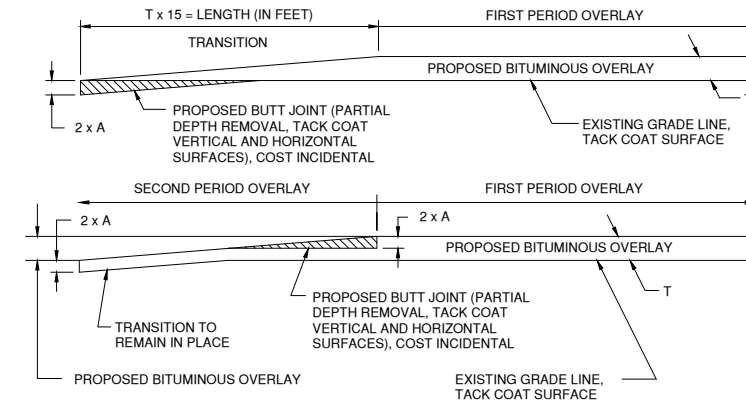

T = THICKNESS OF OVERLAY/LIFT (INCHES)
A = SIZE OF MAXIMUM AGGREGATE (INCHES)

TEMPORARY BITUMINOUS TRANSITION RAMP
NO SCALE

IL. CONTRACT: **PA059**
IL. LETTING ITEM: **18A**
IL. PROJECT: **PWK-4414**
S.B.G. PROJECT: **3-17-SBGP-XX**

SURVEY BOOK # 1302

REVISIONS

NUMBER	BY	DATE

0 1 2
THIS BAR IS EQUAL TO 2" AT FULL SCALE (34x22).

**CHICAGO EXECUTIVE AIRPORT
WHEELING/PROSPECT HEIGHTS, ILLINOIS
REHABILITATE RUNWAY 16/34**

**SEQUENCE OF CONSTRUCTION
GENERAL NOTES AND DETAILS 2**

SUGGESTED SEQUENCE OF CONSTRUCTION

PHASE 1, WEEKEND 1

1. PLACE BARRICADES AND CLOSURE MARKERS AS SHOWN.
2. MILL EXISTING RUNWAY 16/34 PAVEMENT TO CREATE A SUITABLY SIZED AREA FOR THE BITUMINOUS SURFACE TEST SECTION. MILL DEPTH SHALL NOT EXCEED 2 INCHES.
3. PLACE BITUMINOUS SURFACE COURSE FOR TEST SECTION. COMPLETE TESTING REQUIREMENTS AS OUTLINED BY THE DIVISION OF AERONAUTICS.
4. REPLACE RUNWAY MARKINGS DISTURBED BY TEST SECTION WITH TEMPORARY MARKINGS.
5. OPTIONAL: BEGIN WORK TO REPLACE LAHSO LIGHT INSTALLATION AND ELECTRICAL IMPROVEMENTS.
6. CLEANUP AND REMOVE BARRICADES AND CLOSURE MARKERS.

PHASE 1, WEEKEND 2

1. PLACE BARRICADES AND CLOSURE MARKERS AS SHOWN.
2. CONTINUE ELECTRICAL IMPROVEMENTS.
3. MILL BITUMINOUS PAVEMENT WITHIN LIMITS SHOWN. ONLY THE AREA THAT CAN BE COVERED WITH ONE LIFT OF BITUMINOUS SURFACE COURSE (2") SHALL BE MILLED.
4. PLACE FIRST LIFT OF BITUMINOUS OVERLAY (2") ON RUNWAY 16/34 IN MILLED AREA.
5. PLACE TEMPORARY PAVEMENT MARKINGS WITHIN LIMITS OF NEW BITUMINOUS PAVEMENT PLACEMENT. TEMPORARY MARKINGS ARE ONLY REQUIRED ON RUNWAY 6/24, 12/30 AND 16/34.
6. CLEANUP AND REMOVE BARRICADES AND CLOSURE MARKERS.

PHASE 1, WEEKEND 3

1. PLACE BARRICADES AND CLOSURE MARKERS AS SHOWN.
2. CONTINUE ELECTRICAL IMPROVEMENTS.
3. CONTINUE PAVEMENT MILLING WITHIN LIMITS SHOWN.
4. PLACE FIRST LIFT OF BITUMINOUS OVERLAY (2") ON RUNWAY 16/34 IN MILLED AREA.
5. PLACE TEMPORARY PAVEMENT MARKINGS WITHIN LIMITS OF NEW BITUMINOUS PAVEMENT PLACEMENT.
6. CLEANUP AND REMOVE BARRICADES AND CLOSURE MARKERS.

PHASE 1, WEEKEND 4

1. PLACE BARRICADES AND CLOSURE MARKERS AS SHOWN.
2. CONTINUE ELECTRICAL IMPROVEMENTS.
3. CONTINUE PAVEMENT MILLING WITHIN LIMITS SHOWN.
4. PLACE FIRST LIFT OF BITUMINOUS OVERLAY (2") ON RUNWAY 16/34 IN MILLED AREA.
5. PLACE TEMPORARY PAVEMENT MARKINGS WITHIN LIMITS OF NEW BITUMINOUS PAVEMENT PLACEMENT.
6. CLEANUP AND REMOVE BARRICADES AND CLOSURE MARKERS.

PHASE 1, WEEKEND 5

1. PLACE BARRICADES AND CLOSURE MARKERS AS SHOWN.
2. CONTINUE ELECTRICAL IMPROVEMENTS.
3. COMPLETE PAVEMENT MILLING WITHIN LIMITS SHOWN.
4. COMPLETE FIRST LIFT OF BITUMINOUS OVERLAY (2") ON RUNWAY 16/34 IN MILLED AREA.
5. PLACE TEMPORARY PAVEMENT MARKINGS WITHIN LIMITS OF NEW BITUMINOUS PAVEMENT PLACEMENT.
6. CLEANUP AND REMOVE BARRICADES AND CLOSURE MARKERS.

PHASE 1, WEEKEND 6

1. PLACE BARRICADES AND CLOSURE MARKERS AS SHOWN.
2. CONTINUE ELECTRICAL IMPROVEMENTS.
3. PLACE SECOND LIFT OF BITUMINOUS OVERLAY (2") ON RUNWAY 16/34 (FULL LENGTH OF LIMITS SHOWN). COMPLETE SHOULDER ADJUSTMENT AND LANDSCAPING.
4. PLACE TEMPORARY PAVEMENT MARKINGS WITHIN LIMITS OF NEW BITUMINOUS PAVEMENT PLACEMENT.
5. CONSTRUCT BUTT JOINT, PLACE 2" BITUMINOUS SURFACE COURSE AND PLACE PERMANENT PAVEMENT MARKINGS ON CONNECTING TAXIWAYS K/L, K2/L2 AND K3/L3.
6. CLEANUP AND REMOVE BARRICADES AND CLOSURE MARKERS.

PHASE 2, WEEKEND 7

1. PLACE BARRICADES AND CLOSURE MARKERS AS SHOWN.
2. CONTINUE ELECTRICAL IMPROVEMENTS.
3. MILL BITUMINOUS PAVEMENT (RUNWAY 16/34) AND PLACE FIRST LIFT OF BITUMINOUS SURFACE COURSE.
4. PLACE TEMPORARY PAVEMENT MARKINGS WITHIN LIMITS OF NEW BITUMINOUS PAVEMENT PLACEMENT.
5. CLEANUP AND REMOVE BARRICADES AND CLOSURE MARKERS.

PHASE 2, WEEKEND 8

1. PLACE BARRICADES AND CLOSURE MARKERS AS SHOWN.
2. CONTINUE ELECTRICAL IMPROVEMENTS.
3. PLACE SECOND LIFT OF BITUMINOUS OVERLAY ON RUNWAY 16/34.
4. CONSTRUCT BUTT JOINT AND PLACE 2" BITUMINOUS PAVEMENT ON RUNWAYS 6/24 AND 12/30 AND TAXIWAY E. SHOULDER ADJUSTMENT AND LANDSCAPING.
5. PLACE TEMPORARY PAVEMENT MARKINGS ON RUNWAYS 12/30 AND 16/34. PLACE PERMANENT PAVEMENT MARKINGS ON RUNWAY 6/24 AND TAXIWAY E.
6. CLEANUP AND REMOVE BARRICADES AND CLOSURE MARKERS.

PHASE 3, WEEKENDS 9 AND 10

1. PLACE BARRICADES AND CLOSURE MARKERS AS SHOWN.
2. COMPLETE ELECTRICAL IMPROVEMENTS.
3. MILL RUNWAY 16/34 AND PLACE FIRST AND SECOND LIFT OF BITUMINOUS OVERLAY.
4. CONSTRUCT BUTT JOINT AND PLACE 2" BITUMINOUS PAVEMENT ON TAXIWAYS D, L4 AND K5/L5. SHOULDER ADJUSTMENT AND LANDSCAPING.
5. PLACE TEMPORARY PAVEMENT MARKINGS ON RUNWAY 16/34. PLACE PERMANENT PAVEMENT MARKINGS ON TAXIWAYS D, L4 AND K5/L5.
6. CLEANUP AND REMOVE BARRICADES AND CLOSURE MARKERS.

PHASE 4, WEEKEND 10

1. PLACE BARRICADES AND CLOSURE MARKERS AS SHOWN.
2. PERFORM GROOVING TEST STRIP.
3. GROOVE RUNWAY 12/30 AND 16/34 WITHIN THE LIMITS SHOWN.
4. CONTINUOUSLY CLEAN WASTE FROM GROOVING OPERATIONS.
5. PLACE PERMANENT PAVEMENT MARKINGS ON RUNWAYS 12/30 AND 16/34 WITHIN THE LIMITS SHOWN.
6. COMPLETE PUNCH LIST ITEMS WITHIN LIMITS SHOWN.
7. CLEANUP AND REMOVE BARRICADES AND CLOSURE MARKERS.

PHASE 5, WEEKEND 11

1. PLACE BARRICADES AND CLOSURE MARKERS AS SHOWN.
2. GROOVE RUNWAY 16/34 WITHIN THE LIMITS SHOWN.
3. CONTINUOUSLY CLEAN WASTE FROM GROOVING OPERATIONS.
4. PLACE PERMANENT PAVEMENT MARKINGS ON RUNWAY 16/34 WITHIN THE LIMITS SHOWN.
5. COMPLETE PUNCH LIST ITEMS WITHIN LIMITS SHOWN.
6. CLEANUP AND REMOVE BARRICADES AND CLOSURE MARKERS.
7. ASSIST FAA WITH FLIGHT CHECK AS REQUIRED (COORDINATE TURNING ON NAVAIDS, COORDINATE TIME OF FLIGHT CHECK).

ALL PHASES

1. ALL MILLED SURFACES SHALL BE COVERED BY AT LEAST ONE LIFT OF BITUMINOUS SURFACE COURSE PRIOR TO REOPENING THE RUNWAY.
2. TURF SHOULDER SHALL BE CONTINUOUSLY GRADED TO BE FLUSH WITH THE PAVEMENT EDGE TO NO MORE THAN 3 INCHES BELOW PAVEMENT EDGE.
3. FINAL LIFT OF OVERLAY ON RUNWAY 16/34 SHALL BE PLACED IN NO MORE THAN THREE LONGITUDINAL SECTIONS, RESULTING IN NO MORE THAN TWO (2) FULL WIDTH TRANSVERSE COLD JOINTS IN THE FINISHED SURFACE.

© Copyright CMT, Inc.

CMT
CRAWFORD MURPHY & TILLY, INC.
CONSULTING ENGINEERS
License No. 184-000613

CHICAGO EXECUTIVE AIRPORT

DESIGN BY: SMS
DRAWN BY: JRO
CHECKED BY: SMS
APPROVED BY: DKP
DATE: 06/19/2015
JOB No: 14290-05-00

FINAL

DATE: Thursday, July 9, 2015, 09:27:00
 FILE: K:\Chicago\res\14290-05-Relat\16-34\Draw\Sheets\11_SUGGESTED_SCHEDULE.dwg
 UPDATE BY: Sean Smith
 LAYOUT: 11_SCH.D
 IMAGE FILES: pwknewLOGO_CEA-4-Color-Small (2).jpg
 XREF DWG: bchint_runway.dwg

ANTICIPATED ACCELERATED CONSTRUCTION SCHEDULE

ITEM	DESCRIPTION	ANTICIPATED ACCELERATED CONSTRUCTION SCHEDULE										
		PHASE 1						PHASE 2		PHASE 3	PHASE 4	PHASE 5
		Weekend 1 10PM Fri -6AM Mon 5	Weekend 2 10PM Fri -6AM Mon 5	Weekend 3 10PM Fri -6AM Mon 5	Weekend 4 10PM Fri -6AM Mon 5	Weekend 5 10PM Fri -6AM Mon 5	Weekend 6 10PM Fri -6AM Mon 5	Weekend 7 10PM Fri -6AM Mon 5	Weekend 8 10PM Fri -6AM Mon 5	Weekend 9 10PM Fri -6AM Mon 5	Weekend 10 10PM Fri -6AM Mon 5	Weekend 11 10PM Fri -6AM Mon 5
WORK PERIODS	WORK PERIODS	WORK PERIODS	WORK PERIODS	WORK PERIODS	WORK PERIODS	WORK PERIODS	WORK PERIODS	WORK PERIODS	WORK PERIODS	WORK PERIODS	WORK PERIODS	
ALL PHASES - PRIOR TO CLOSING RUNWAY												
-	Coordinate temporary Runway 16/34 closure with Engineer and Airport.											
-	Coordinate FAA NAVaids shutdown with FAA.											
-	Disconnect appropriate electrical circuits in airfield vault.											
-	Place temporary runway closure markers at ends of closed runway(s).											
-	Place barricades and cones as shown or as directed by the Airport.											
ALL PHASES - PRIOR TO OPENING RUNWAY												
-	Patchfill all trenches and grade in conformance with plans in runway safety area.											
-	Place temporary pavement markings in conformance with plans.											
-	Turn on and check all appropriate electrical circuits in airfield vault.											
-	Sweep Runway, perform safety inspection with Airport and coordinate runway opening.											
PHASE 1 - MILL AND OVERLAY NORTH PORTION OF RUNWAY 16/34 AND CONNECTING TAXIWAYS												
AR108XXX	CABLE											
AR110202	2" PVC DUCT, DIRECT BURY											
AR110 / 125 / 800 / 910	ELEC. ITEMS, ADJUSTMENTS, MARKERS & SIGNS											
AR150520	MOBILIZATION											
AR152480	SHOULDER ADJUSTMENT											
AR156XXX	EROSION CONTROL & SWPPP											
AR401610	BITUMINOUS SURFACE COURSE											
AR401630	BITUMINOUS SURFACE TEST SECTION											
AR401XXX	BIT. PAVEMENT MILLING & BUTT JOINT CONSTRUCTION											
AR603510	BITUMINOUS TACK COAT											
AR6205XX	PAVEMENT MARKING											
AR620590	TEMPORARY PAVEMENT MARKING											
AR901/AR904/AR908	LANDSCAPING											
PHASE 2 - MILL AND OVERLAY RUNWAY 6/24, 12/30 AND 16/34 INTERSECTION												
AR108XXX	CABLE											
AR110202	2" PVC DUCT, DIRECT BURY											
AR110 / 125 / 800 / 910	ELEC. ITEMS, ADJUSTMENTS, MARKERS & SIGNS											
AR152480	SHOULDER ADJUSTMENT											
AR156XXX	EROSION CONTROL & SWPPP											
AR401610	BITUMINOUS SURFACE COURSE											
AR401XXX	BIT. PAVEMENT MILLING & BUTT JOINT CONSTRUCTION											
AR603510	BITUMINOUS TACK COAT											
AR6205XX	PAVEMENT MARKING											
AR620590	TEMPORARY PAVEMENT MARKING											
AR901/AR904/AR908	LANDSCAPING											
PHASE 3 - MILL AND OVERLAY SOUTHERN PORTION OF RUNWAY 16/34 AND CONNECTING TAXIWAYS												
AR108XXX	CABLE											
AR110202	2" PVC DUCT, DIRECT BURY											
AR110 / 125 / 800 / 910	ELEC. ITEMS, ADJUSTMENTS, MARKERS & SIGNS											
AR152480	SHOULDER ADJUSTMENT											
AR156XXX	EROSION CONTROL & SWPPP											
AR401610	BITUMINOUS SURFACE COURSE											
AR401XXX	BIT. PAVEMENT MILLING & BUTT JOINT CONSTRUCTION											
AR603510	BITUMINOUS TACK COAT											
AR6205XX	PAVEMENT MARKING											
AR620590	TEMPORARY PAVEMENT MARKING											
AR901/AR904/AR908	LANDSCAPING											
PHASE 4 - GROOVE AND PAINT SOUTHERN HALF OF RUNWAY 16/34 AND RUNWAY 12/30												
AR401640	BITUMINOUS PAVEMENT GROOVING											
AR6205XX	PAVEMENT MARKING											
PHASE 5 - GROOVE AND PAINT NORTHERN HALF OF RUNWAY 16/34												
AR401640	BITUMINOUS PAVEMENT GROOVING											
AR6205XX	PAVEMENT MARKING											
END OF PROJECT												
-	Coordinate turning on FAA NAVaids with FAA.											
-	Coordinate FAA Flight Check with Engineer, Airport and FAA.											

NOTES:

- ASSUMPTION: 1 WORK PERIOD = 8 HOURS OF WORK
1 WEEKEND 10 PM FRIDAY TO 6 AM MONDAY = 56 HOURS. ANTICIPATE 40 HOURS WORK PER WEEKEND = 5 WORK PERIODS. REMAINING TIME IS BUFFER FOR OPENING, EMERGENCIES AND WEATHER.
- WEEKNIGHT CLOSURES, IF APPROVED, SHALL BE FROM 10 PM THROUGH 6 AM THE FOLLOWING DAY, MONDAY THROUGH THURSDAY.
- AS APPROVED BY THE AIRPORT, ADDITIONAL WEEKNIGHT CLOSURES AND/OR WEEKEND CLOSURES MAY BE REQUIRED TO COMPLETE THE PROJECT IF CLOSURES ARE CANCELED DUE TO ADVERSE WEATHER CONDITIONS.
- A PASSING FAA FLIGHT INSPECTION IS REQUIRED PRIOR TO RETURNING FAA EQUIPMENT BACK TO SERVICE. THE FAA WILL PERFORM THE FLIGHT INSPECTION FOR THE FAA EQUIPMENT ON RUNWAY 16/34 AFTER THE PROJECT HAS BEEN COMPLETED BY THE CONTRACTOR. THE INITIAL COST OF THE FLIGHT INSPECTION SHALL BE THE RESPONSIBILITY OF THE AIRPORT. IF A FLIGHT INSPECTION IS REQUIRED TO RE-INSPECT THE SYSTEM DUE TO IMPROPER INSTALLATION BY THE CONTRACTOR INCLUDING, BUT NOT LIMITED TO AN ADJUSTMENT, EQUIPMENT MALFUNCTION OR CONSTRUCTION NOT COMPLETED, THE ADDITIONAL CHARGE FOR SUBSEQUENT FLIGHT INSPECTIONS SHALL BE BORNE BY THE CONTRACTOR. THE COST FOR ANN FAA FLIGHT INSPECTION AT THIS LOCATION IS APPROXIMATELY \$10,000 PER THE FAA REIMBURSABLE AGREEMENT.

NOTES (CONTINUED):

- IT SHALL BE UNDERSTOOD THAT AFTER PAVING IS COMPLETE, BITUMINOUS PAVEMENT GROOVING WILL BE THE CONTROLLING ITEM, WHICH REQUIRES A CURE TIME OF 28 DAYS. WHILE CALENDAR DAYS WILL BE RECORDED, THESE DAYS WILL BE CONSIDERED UNWORKABLE. BASED ON THE SUGGESTED SEQUENCE AND SCHEDULE, IT IS ESTIMATED THAT 21 DAYS WILL NOT BE CHARGED AGAINST CONTRACT TIME.
- ONE ADDITIONAL WEEKEND CLOSURE (WEEKEND 12) WILL BE ALLOWED FOR FINAL CLEANUP AND PUNCH LIST ITEMS.

IL. CONTRACT: **PA059**
 IL. LETTING ITEM: **18A**
 IL. PROJECT: **PWK-4414**
 S.B.G. PROJECT: **3-17-SBGP-XX**

SURVEY BOOK # 1302

REVISIONS

NUMBER	BY	DATE

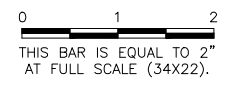

CHICAGO EXECUTIVE AIRPORT
WHEELING/PROSPECT HEIGHTS, ILLINOIS
REHABILITATE RUNWAY 16/34

SEQUENCE OF CONSTRUCTION
SUGGESTED SCHEDULE AND DURATION

© Copyright CMT, Inc.

CMT
 CRAWFORD, MURPHY & TILLY, INC.
 CONSULTING ENGINEERS
 License No. 184-000613

CHICAGO EXECUTIVE AIRPORT

DESIGN BY:	SMS
DRAWN BY:	JRO
CHECKED BY:	SMS
APPROVED BY:	DKP
DATE:	06/19/2015
JOB No:	14290-05-00

FINAL

REF DWG: 16chil_cranoy.dwg
C:\Users\j\OneDrive - NEW.dwg
CDL Alignment.dwg

IMAGE FILES: pwrkwlogo_cea-4-Color-Small (2).jpg

UPDATE BY: Sean Smith
LAYOUT: SWPPP

DATE: Thursday, July 9, 2015, 09:27:41
FILE: K:\Chicago\14290-05_Rehab\16-34_Drum_Sheets\12_SWPPP.dwg

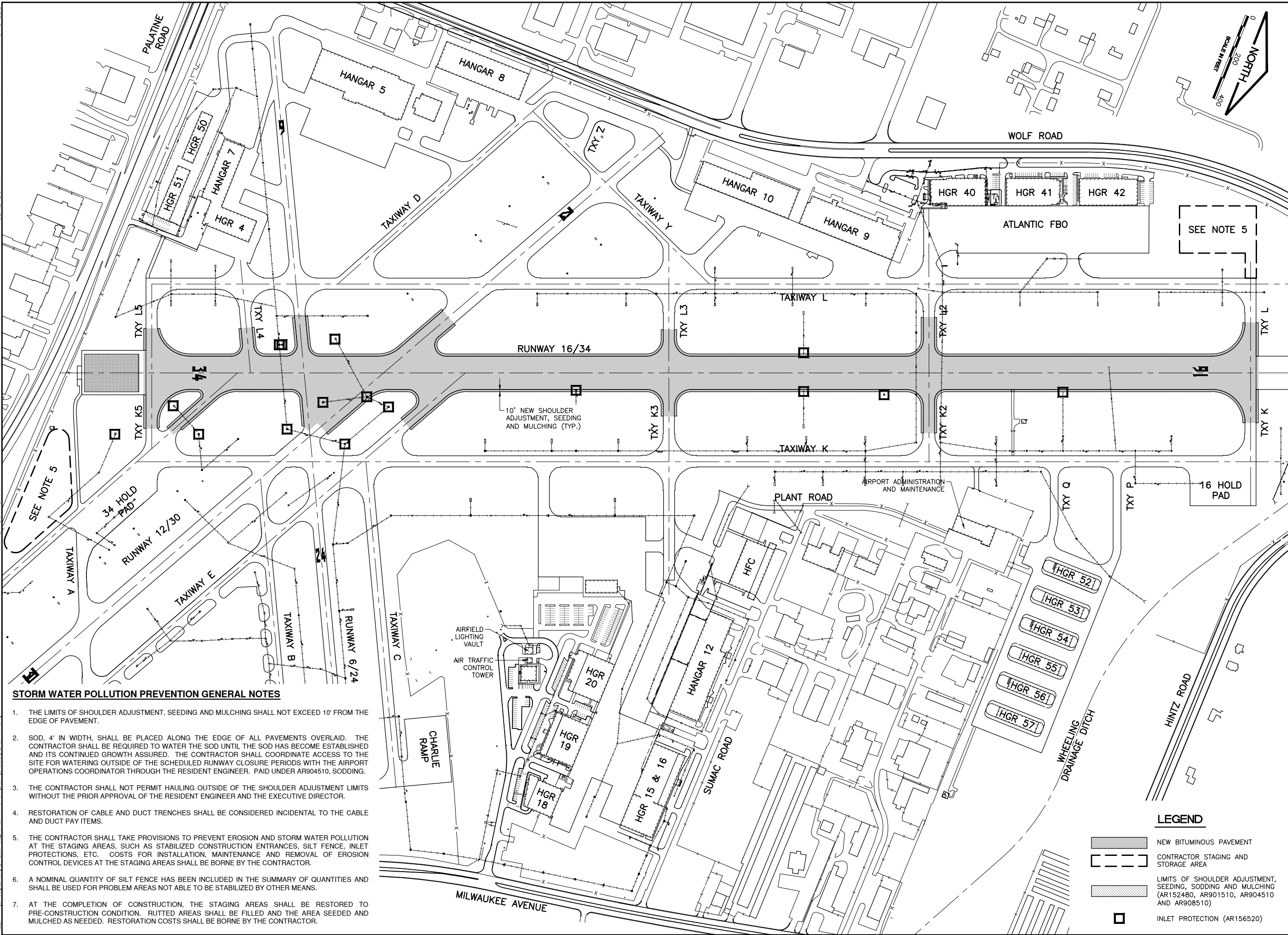

IL CONTRACT: **PA059**
 IL LETTING ITEM: **18A**
 IL PROJECT: **PWK-4414**
 S.B.G. PROJECT: **3-17-SBGP-XX**

SURVEY BOOK # 1302

REVISIONS		
NUMBER	BY	DATE

0 1 2
 THIS BAR IS EQUAL TO 2"
 AT FULL SCALE (34X22).

**CHICAGO EXECUTIVE AIRPORT
 WHEELING/PROSPECT HEIGHTS, ILLINOIS
 REHABILITATE RUNWAY 16/34
 STORM WATER POLLUTION PREVENTION PLAN**

STORM WATER POLLUTION PREVENTION GENERAL NOTES

1. THE LIMITS OF SHOULDER ADJUSTMENT, SEEDING AND MULCHING SHALL NOT EXCEED 10' FROM THE EDGE OF PAVEMENT.
2. SOD, 4" IN WIDTH, SHALL BE PLACED ALONG THE EDGE OF ALL PAVEMENTS OVERLAID. THE CONTRACTOR SHALL BE REQUIRED TO WATER THE SOD UNTIL THE SOD HAS BECOME ESTABLISHED AND ITS CONTINUED GROWTH ASSURED. THE CONTRACTOR SHALL COORDINATE ACCESS TO THE SITE FOR WATERING OUTSIDE OF THE SCHEDULED RUNWAY CLOSURE PERIODS WITH THE AIRPORT OPERATIONS COORDINATOR THROUGH THE RESIDENT ENGINEER. PAID UNDER AR904510, SODDING.
3. THE CONTRACTOR SHALL NOT PERMIT HAULING OUTSIDE OF THE SHOULDER ADJUSTMENT LIMITS WITHOUT THE PRIOR APPROVAL OF THE RESIDENT ENGINEER AND THE EXECUTIVE DIRECTOR.
4. RESTORATION OF CABLE AND DUCT TRENCHES SHALL BE CONSIDERED INCIDENTAL TO THE CABLE AND DUCT PAY ITEMS.
5. THE CONTRACTOR SHALL TAKE PROVISIONS TO PREVENT EROSION AND STORM WATER POLLUTION AT THE STAGING AREAS, SUCH AS STABILIZED CONSTRUCTION ENTRANCES, SILT FENCE, INLET PROTECTIONS, ETC. COSTS FOR INSTALLATION, MAINTENANCE AND REMOVAL OF EROSION CONTROL DEVICES AT THE STAGING AREAS SHALL BE BORNE BY THE CONTRACTOR.
6. A NOMINAL QUANTITY OF SILT FENCE HAS BEEN INCLUDED IN THE SUMMARY OF QUANTITIES AND SHALL BE USED FOR PROBLEM AREAS NOT ABLE TO BE STABILIZED BY OTHER MEANS.
7. AT THE COMPLETION OF CONSTRUCTION, THE STAGING AREAS SHALL BE RESTORED TO PRE-CONSTRUCTION CONDITION. RUTTED AREAS SHALL BE FILLED AND THE AREA SEEDING AND MULCHED AS NEEDED. RESTORATION COSTS SHALL BE BORNE BY THE CONTRACTOR.

LEGEND

- NEW BITUMINOUS PAVEMENT
- CONTRACTOR STAGING AND STORAGE AREA
- LIMITS OF SHOULDER ADJUSTMENT, SEEDING, SODDING AND MULCHING (AR152480, AR901510, AR904510 AND AR908510)
- INLET PROTECTION (AR156520)

© Copyright CMT, Inc.

CMT
 CRAWFORD, MURPHY & TILLY, INC.
 CONSULTING ENGINEERS
 License No. 184-000613

CHICAGO EXECUTIVE AIRPORT

DESIGN BY:	SMS
DRAWN BY:	JRO
CHECKED BY:	SMS
APPROVED BY:	DKP
DATE:	06/19/2015
JOB No:	14290-05-00

FINAL

SHEET 12 OF 58 SHEETS

STORM WATER POLLUTION PREVENTION PLAN

THE FOLLOWING PLAN IS ESTABLISHED AND INCORPORATED IN THE PROJECT TO DIRECT THE CONTRACTOR IN THE PLACEMENT OF TEMPORARY EROSION CONTROL SYSTEMS AND TO PROVIDE A STORM WATER POLLUTION PREVENTION PLAN FOR COMPLIANCE WITH NPDES.

THE PURPOSE OF THIS PLAN IS TO MINIMIZE EROSION WITHIN THE CONSTRUCTION SITE AND TO LIMIT SEDIMENTS FROM LEAVING THE SITE BY UTILIZING PROPER TEMPORARY EROSION CONTROL SYSTEMS AND PROVIDING GROUND COVER WITHIN A REASONABLE AMOUNT OF TIME.

CERTAIN EROSION CONTROL FACILITIES SHALL BE INSTALLED BY THE CONTRACTOR AT THE BEGINNING OF CONSTRUCTION. OTHER ITEMS SHALL BE INSTALLED BY THE CONTRACTOR AS DIRECTED BY THE ENGINEER ON A CASE BY CASE SITUATION DEPENDING ON THE CONTRACTOR'S SEQUENCE OF ACTIVITIES, TIME OF YEAR, AND EXPECTED WEATHER CONDITIONS.

THE CONTRACTOR SHALL INSTALL PERMANENT EROSION CONTROL SYSTEMS AND SEEDING WITHIN A TIMEFRAME SPECIFIED HEREIN AND AS DIRECTED BY THE ENGINEER, THEREFORE MINIMIZING THE AMOUNT OF AREA SUSCEPTIBLE TO EROSION AND REDUCING THE AMOUNT OF TEMPORARY SEEDING, WHICH WILL BE AT THE CONTRACTOR'S COST. THE ENGINEER WILL DETERMINE IF ANY TEMPORARY EROSION CONTROL SYSTEMS SHOWN IN THE PLAN CAN BE DELETED AND IF ANY ADDITIONAL TEMPORARY EROSION CONTROL SYSTEMS, WHICH ARE NOT INCLUDED IN THIS PLAN, SHALL BE ADDED. THE CONTRACTOR SHALL PERFORM ALL WORK AS DIRECTED BY THE ENGINEER AND AS SHOWN ON THE PLANS.

SITE DESCRIPTION:

THE FOLLOWING IS A DESCRIPTION OF THE CONSTRUCTION ACTIVITY WHICH IS THE SUBJECT OF THIS PLAN:

THIS PROJECT CONSISTS OF REHABILITATION OF AN EXISTING BITUMINOUS PAVEMENT AT THE CHICAGO EXECUTIVE AIRPORT. THE PROJECT INCLUDES TURF SHOULDER ADJUSTMENT, VARIOUS PAVEMENT ITEMS, ELECTRICAL WORK, PAVEMENT MARKING AND OTHER MISCELLANEOUS CONSTRUCTION WORK.

DESCRIPTION OF CONSTRUCTION ACTIVITY:

THE FOLLOWING IS A DESCRIPTION OF THE INTENDED SEQUENCE OF MAJOR ACTIVITIES WHICH WILL DISTURB SOILS FOR MAJOR PORTIONS OF THE CONSTRUCTION SITE, SUCH AS GRUBBING, EXCAVATION AND GRADING:

- PLACEMENT, MAINTENANCE, REMOVAL AND PROPER CLEAN-UP OF TEMPORARY EROSION CONTROL. SUCH AS INLET PROTECTION.
- REMOVAL, ADJUSTMENTS AND INSTALLATION OF ELECTRICAL AND MISCELLANEOUS ITEMS.
- VARIABLE DEPTH BITUMINOUS PAVEMENT MILLING AND PAVING.
- TURF SHOULDER ADJUSTMENT, SODDING, SEEDING AND MULCHING.
- BITUMINOUS PAVEMENT GROOVING.
- INSTALLATION OF NEW PAVEMENT MARKING.
- REMOVAL AND DISPOSAL OF TEMPORARY SOIL EROSION AND SEDIMENT CONTROL MEASURES.

AREA OF CONSTRUCTION SITE:

THE TOTAL AREA OF THE CONSTRUCTION SITE IS ESTIMATED TO BE 25 ACRES OF WHICH 3 ACRES WILL BE DISTURBED BY GRADING AND OTHER ACTIVITIES.

OTHER REPORTS, STUDIES AND PLANS WHICH AID IN THE DEVELOPMENT OF THE STORM WATER POLLUTION PREVENTION PLAN AS REFERENCED DOCUMENTS:

1. INFORMATION OF THE SOILS AND TERRAIN WITHIN THE SITE WAS OBTAINED FROM TOPOGRAPHIC SURVEYS AND SOIL BORINGS THAT WERE UTILIZED FOR THE DEVELOPMENT OF THE PROPOSED TEMPORARY EROSION CONTROL SYSTEMS.
2. PROJECT PLAN DOCUMENTS, SPECIFICATION AND SPECIAL PROVISIONS, AND PLAN DRAWINGS INDICATING DRAINAGE PATTERNS AND APPROXIMATE SLOPES ANTICIPATED AFTER GRADING ACTIVITIES WERE UTILIZED FOR THE PROPOSED PLACEMENT OF THE TEMPORARY EROSION CONTROL SYSTEMS.

DRAINAGE TRIBUTARIES AND SENSITIVE AREAS RECEIVING RUNOFF FROM THIS CONSTRUCTION SITE:

THE CONSTRUCTION SITE DRAINS INTO THE DES PLAINES RIVER THROUGH A STORM SEWER SYSTEM.

EROSION AND SEDIMENT CONTROL:

DESCRIPTION OF STABILIZATION PRACTICES AT THE BEGINNING OF CONSTRUCTION:

THE DRAWINGS SPECIFICATIONS AND SPECIAL PROVISIONS WILL ENSURE THAT EXISTING VEGETATION IS PRESERVED WHERE ATTAINABLE AND DISTURBED PORTIONS OF THE SITE WILL BE STABILIZED. STABILIZATION PRACTICES INCLUDE: TEMPORARY SEEDING, PERMANENT SEEDING, MULCHING, SOD, PROTECTION OF TREES, PRESERVATION OF NATURAL VEGETATION, AND ALL OTHER APPROPRIATE MEASURES AS DIRECTED BY THE ENGINEER. STABILIZATION MEASURES SHALL BE INITIATED AS SOON AS PRACTICABLE IN PORTIONS OF THE SITE WHERE CONSTRUCTION ACTIVITIES HAVE TEMPORARILY OR PERMANENTLY CEASED, BUT IN NO CASE MORE THAN 7 DAYS AFTER THE CONSTRUCTION ACTIVITY IN THAT PORTION OF THE SITE HAS TEMPORARILY OR PERMANENTLY CEASED.

AREAS OF EXISTING VEGETATION (WOOD AND GRASSLANDS) OUTSIDE THE PROPOSED CONSTRUCTION LIMITS SHALL BE IDENTIFIED BY THE ENGINEER FOR PRESERVING AND SHALL BE PROTECTED FROM CONSTRUCTION ACTIVITIES.

DEAD, DISEASED, OR UNSUITABLE VEGETATION WITHIN THE SITE SHALL BE REMOVED AS DIRECTED BY THE ENGINEER.

AS SOON AS REASONABLE ACCESS IS AVAILABLE TO ALL LOCATIONS WHERE WATER DRAINS AWAY FROM THE PROJECT, INLET PROTECTIONS SHALL BE INSTALLED AS CALLED OUT IN THE PLAN AND DIRECTED BY THE ENGINEER.

THIS PLAN HAS BEEN PREPARED TO COMPLY WITH THE PROVISIONS OF THE NPDES PERMIT NUMBER ILR10, ISSUED BY THE ILLINOIS ENVIRONMENTAL PROTECTION AGENCY FOR STORM WATER DISCHARGES FROM CONSTRUCTION SITE ACTIVITIES.

DESCRIPTION OF STABILIZATION PRACTICES DURING CONSTRUCTION:

DURING CONSTRUCTION, AREAS OUTSIDE THE CONSTRUCTION LIMITS AS OUTLINED PREVIOUSLY HEREIN SHALL BE PROTECTED. THE CONTRACTOR SHALL NOT USE THIS AREA FOR STAGING (EXCEPT AS DESCRIBED ON THE PLANS AND DIRECTED BY THE ENGINEER), PARKING OF VEHICLES OR CONSTRUCTION EQUIPMENT, STORAGE OF MATERIALS, OR OTHER CONSTRUCTION RELATED ACTIVITIES.

WITHIN THE CONSTRUCTION LIMITS, AREAS WHICH MAY BE SUSCEPTIBLE TO EROSION AS DETERMINED BY THE ENGINEER SHALL REMAIN UNDISTURBED UNTIL FULL SCALE CONSTRUCTION IS UNDERWAY TO PREVENT UNNECESSARY SOIL EROSION.

EARTH STOCKPILES SHALL BE TEMPORARILY SEEDED AT THE CONTRACTOR'S EXPENSE, IF THEY ARE TO REMAIN UNUSED FOR MORE THAN SEVEN (7) DAYS.

THE DOWN STREAM SIDE OF ALL STOCKPILES SHALL BE ENCOMPASSED WITH EROSION CONTROL BARRIER.

AS CONSTRUCTION PROCEEDS, THE CONTRACTOR SHALL INSTITUTE THE FOLLOWING AS DIRECTED BY THE ENGINEER:

A. PLACE TEMPORARY EROSION CONTROL FACILITIES AT LOCATIONS SHOWN ON THE PLANS.

CONSTRUCTION EQUIPMENT SHALL BE STORED AND FUELED ONLY AT DESIGNATED LOCATIONS WITHIN THE STAGING AREA. ALL NECESSARY MEASURES SHALL BE TAKEN TO CONTAIN ANY FUEL OR POLLUTANT IN ACCORDANCE WITH EPA WATER QUALITY REGULATIONS. LEAKING EQUIPMENT OR SUPPLIES SHALL BE IMMEDIATELY REPAIRED OR REMOVED FROM THE SITE.

THE RESIDENT ENGINEER SHALL INSPECT THE PROJECT PERIODICALLY DURING CONSTRUCTION ACTIVITIES. INSPECTION SHALL ALSO BE DONE WEEKLY AND AFTER RAINS OF 1/2" OR GREATER OR EQUIVALENT SNOWFALL AND DURING WINTER SHUTDOWN PERIOD. THE PROJECT SHALL ADDITIONALLY BE INSPECTED BY THE RESIDENT ENGINEER ON A BI-WEEKLY BASIS TO DETERMINE THAT THE EROSION AND SEDIMENT CONTROL EFFORTS ARE IN PLACE AND EFFECTIVE AND IF OTHER EROSION CONTROL WORK IS NECESSARY.

SEDIMENT COLLECTED DURING CONSTRUCTION OF THE VARIOUS TEMPORARY EROSION CONTROL SYSTEMS SHALL BE DISPOSED OF ON SITE ON A REGULAR BASIS AS DIRECTED BY THE ENGINEER. THE COST OF THIS MAINTENANCE SHALL BE INCLUDED IN THE UNIT BID PRICE FOR UNCLASSIFIED EXCAVATION AND EROSION CONTROL ITEMS.

THE TEMPORARY EROSION CONTROL SYSTEMS SHALL BE REMOVED AS DIRECTED BY THE ENGINEER AFTER USE IS NO LONGER NEEDED OR NO LONGER FUNCTIONING. THE COST OF THIS REMOVAL SHALL BE INCLUDED IN THE UNIT BID PRICE FOR VARIOUS TEMPORARY EROSION CONTROL PAY ITEMS.

THE CONTRACTOR SHALL BE RESPONSIBLE FOR PREVENTING SOIL CONTAMINATION FROM BUILDING MATERIALS, FERTILIZERS, CHEMICALS, PAVEMENT MARKING, WASTE PILES, FUEL CONTAINMENT, AND ANY OTHER POTENTIAL HAZARDOUS MATERIALS THAT MAY EXIST ONSITE.

NO DEDICATED CONCRETE OR ASPHALT BATCH PLANTS SHALL BE LOCATED ON THIS SITE.

DESCRIPTION OF STRUCTURAL PRACTICES AFTER FINAL GRADING:

TEMPORARY EROSION CONTROL SYSTEMS SHALL BE LEFT IN PLACE WITH PROPER MAINTENANCE UNTIL PERMANENT EROSION CONTROL IS IN PLACE AND WORKING PROPERLY AND ALL PROPOSED TURF AREAS ARE SEEDED AND ESTABLISHED.

COST OF MAINTAINING THE VARIOUS TEMPORARY EROSION CONTROL SYSTEMS SHALL BE INCLUDED INCLUDED IN THE UNIT BID PRICE FOR THE VARIOUS TEMPORARY EROSION CONTROL PAY ITEMS.

ONCE PERMANENT EROSION CONTROL SYSTEMS AS PROPOSED IN THE PLANS ARE FUNCTIONAL AND ESTABLISHED, TEMPORARY ITEMS SHALL BE REMOVED, CLEANED UP, AND DISTURBED TURF RE-SEEDED AND/OR SODDED.

MAINTENANCE AFTER CONSTRUCTION:

CONSTRUCTION IS COMPLETE AFTER FINAL ACCEPTANCE BY THE ILLINOIS DIVISION OF AERONAUTICS. MAINTENANCE OF TEMPORARY AND PERMANENT EROSION CONTROL SYSTEMS UP TO THIS DATE WILL BE REQUIRED BY THE CONTRACTOR.

DOCUMENTATION:

PRIOR TO BEGINNING WORK, THE CONTRACTOR SHALL COMPLETE AND SUBMIT A "NOTICE OF INTENT (NOI)" PROPERLY SIGNED TO THE ILLINOIS ENVIRONMENTAL PROTECTION AGENCY.

PRIOR TO BEGINNING WORK, THE CONTRACTOR SHALL POST A SIGN OR OTHER NOTICE NEAR THE MAIN ENTRANCE OF THE CONSTRUCTION SITE. IF THIS IS NOT POSSIBLE, THEN IT MAY BE PERMITTED TO POST THIS NOTICE IN A LOCAL PUBLIC BUILDING. THE SIGN OR NOTICE MUST CONTAIN THE FOLLOWING:

1. A COPY OF THE COMPLETED NOTICE OF INTENT (NOI) AS SUBMITTED TO THE IEPA
2. THE LOCATION OF THE SWPPP AND NAME AND 24/7 TELEPHONE NUMBER OF THE CONTACT PERSON.

THROUGHOUT CONSTRUCTION, THE CONTRACTOR SHALL MAINTAIN AND UPDATE AN "AS-BUILT" SET OF STORM WATER POLLUTION PREVENTION PLANS IN THE PROJECT FILES. THE SWPPP SHALL BE UPDATED WITHIN 7-DAYS OF ANY MODIFICATIONS TO THE PLANS. THE SWPPP AND ALL REVISIONS SHALL BE RETAINED FOR THREE YEARS AFTER FINAL STABILIZATION OF THE SITE, WHICH SHALL BE DEFINED AS VEGETATION COVER OF AT LEAST 70% OF HISTORIC CONDITIONS.

A STORM WATER POLLUTION PREVENTION PLAN EROSION CONTROL INSPECTION REPORT (FORM BC 2259) SHALL BE COMPLETED WITH INSPECTION FREQUENCIES AS OUTLINED HEREIN. SWPPP REPORTS SHALL BE RETAINED FOR THREE YEARS AFTER THE DATE OF FINAL STABILIZATION AS DEFINED HEREIN.

IF ANY VIOLATION OF THE PROVISIONS OF THE PLAN IS IDENTIFIED DURING THE CONDUCT OF THE CONSTRUCTION COVERED IN THIS PLAN, THE ENGINEER AND/OR CONTRACTOR SHALL COMPLETE AND FILE AN "INCIDENT OF NONCOMPLIANCE (ION)" REPORT FOR THE IDENTIFIED VIOLATION. THE FORMS SHALL BE AS PROVIDED BY THE ILLINOIS ENVIRONMENTAL PROTECTION AGENCY, AND SHALL INCLUDE SPECIFIC INFORMATION ON THE INCIDENT THAT CAUSED NONCOMPLIANCE, ACTIONS THAT WERE TAKEN TO CORRECT THE NONCOMPLIANCE AND TO PREVENT ITS REOCCURRENCE, AND A STATEMENT DETAILING ANY ENVIRONMENTAL IMPACT WHICH MAY HAVE RESULTED FROM THE NONCOMPLIANCE. ALL REPORTS OF NONCOMPLIANCE SHALL BE SIGNED BY A RESPONSIBLE AUTHORITY IN ACCORDANCE WITH PART VI. G. OF THE GENERAL PERMIT.

AFTER PROJECT FINAL ACCEPTANCE, THE CONTRACTOR SHALL COMPLETE AND SUBMIT A "NOTICE OF TERMINATION (NOT)" FORM PROPERLY SIGNED TO THE ILLINOIS ENVIRONMENTAL PROTECTION AGENCY. FORMS FOR THE IEPA SHALL BE MAILED TO THE FOLLOWING ADDRESS"

ILLINOIS ENVIRONMENTAL PROTECTION AGENCY
DIVISION OF WATER POLLUTION CONTROL, MAIL CODE #15
ATTN: PERMIT SECTION
1021 NORTH GRAND AVENUE EAST
P.O. BOX 19276
SPRINGFIELD, ILLINOIS 62794-9276

GENERAL NOTES FOR SOIL EROSION AND SEDIMENT CONTROL:

1. ALL TREE PROTECTION, SEDIMENT CONTROL MEASURES, AND PERMANENT AND TEMPORARY STORM WATER PRACTICES SHALL BE IN PLACE PRIOR TO STARTING CONSTRUCTION.
2. NO WORK SHALL BE PERFORMED IN FLOWING WATER. WORK IN AND NEAR FLOWING WATER SHALL BE ISOLATED FROM CONCENTRATED FLOWS OR STREAM FLOWS AT ALL TIMES. THE USE OF EARTHEN MATERIAL FOR ISOLATION WILL NOT BE ACCEPTABLE.
3. CONSTRUCTION MATERIALS AND/OR OTHER STOCKPILES SHALL NOT BE LOCATED ON STREAM BANKS NOR IN THE PATH OF STREAM FLOW.
4. TEMPORARY EROSION CONTROL DEVICES SHALL BE CONSTRUCTED AS SHOWN ON THE PLANS OR AS DIRECTED BY THE ENGINEER.
5. PERMANENT SEEDING SHALL BE USED WHENEVER POSSIBLE. UNDER NO CIRCUMSTANCES SHALL THE CONTRACTOR PROLONG GRADING OR SHAPING SO THAT THE ENTIRE PROJECT CAN BE PERMANENTLY SEEDED AT ONE TIME.
6. THE CONTRACTOR SHALL INSPECT ADJACENT STREETS DAILY AND CLEAN ADJACENT STREETS WHEN NECESSARY. ADJACENT STREETS SHALL BE KEPT FREE OF SOIL AND DEBRIS.
7. SHOULD IT BE NECESSARY TO REMOVE ANY EROSION CONTROL DEVICES FOR CONSTRUCTION REASONS, THE CONTRACTOR SHALL FIRST OBTAIN PERMISSION AND SHALL REPLACE AND/OR REPAIR THE REMOVED DEVICES THE SAME DAY. THE COST OF REMOVING AND REPLACING THE DEVICE SHALL BE CONSIDERED INCIDENTAL TO THE CONTRACT.
8. ALL OTHER SOIL EROSION AND SEDIMENT CONTROL DEVICES AND MEASURES DEEMED NECESSARY BY THE RESIDENT ENGINEER, COOK COUNTY, CHICAGO EXECUTIVE AIRPORT, IDOT DIVISION OF AERONAUTICS, AND THE IEPA SHALL BE IMPLEMENTED IMMEDIATELY UPON NOTIFICATION OF THE CONTRACTOR.
9. THE CONTRACTOR SHALL PROVIDE LOCATIONS FOR CONCRETE TRUCK WASHOUT, AS APPROVED BY THE ENGINEER, PRIOR TO ANY CONCRETE POURS. THESE LOCATIONS SHALL NOT BE NEAR ANY STREAM OR BODY OF WATER. LOCATIONS SHALL BE APPROVED BY THE ENGINEER PRIOR TO ANY CONCRETE POURS. ADDITIONALLY THE CONTRACTOR SHALL PROVIDE ADEQUATE FACILITIES TO WASH OUT PAVING EQUIPMENT AND FINISHING TOOLS. ALL WASTE WATER AND EXCESS CONCRETE MATERIALS SHALL BE CONTAINED BY AN APPROVED CONCRETE WASHOUT FACILITY.
10. THE CONTRACTOR SHALL COORDINATE CONSTRUCTION ACTIVITIES TO ENSURE THAT EROSION CONTROL MEASURES ARE CONSISTENT BETWEEN ALL PROJECT PHASES AND ALL SUB-CONTRACTORS.
11. THE CONTRACTOR SHALL TAKE ALL PRECAUTIONS TO PROTECT WETLANDS TO REMAIN FROM DAMAGE BY SEDIMENT, CONSTRUCTION EQUIPMENT, OR BY HIS PERSONNEL. THE CONTRACTOR SHALL ASSURE THAT DEBRIS OR ANY CONSTRUCTION MATERIAL IS NOT DISPOSED OF IN THE WETLANDS.
12. WATER PUMPED OR OTHERWISE DISCHARGED FROM THE SITE DURING CONSTRUCTION DEWATERING SHALL BE FILTERED BY AN APPROVED MEANS.
13. SEDIMENT COLLECTED DURING CONSTRUCTION BY THE VARIOUS TEMPORARY EROSION CONTROL SYSTEMS SHALL BE DISPOSED OF ON A REGULAR BASIS. SEDIMENT SHALL BE REMOVED FROM EROSION CONTROL SYSTEMS WHEN THE HEIGHT OF THE SEDIMENT EXCEEDS ONE-HALF OF THE HEIGHT OF THE DEVICE OR AS RECOMMENDED BY THE MANUFACTURER, WHICHEVER IS LESS.
14. ALL EROSION CONTROL MEASURES SHALL BE KEPT OPERATIONAL AND MAINTAINED CONTINUOUSLY THROUGHOUT THE PERIOD OF LAND DISTURBANCE UNTIL PERMANENT SOIL EROSION AND SEDIMENT CONTROL MEASURES ARE OPERATIONAL.
15. THE CONDITION OF THE CONSTRUCTION SITE FOR WINTER SHUTDOWN SHALL BE ADDRESSED EARLY IN THE FALL GROWING SEASON SO THAT SLOPES AND OTHER BARE EARTH AREAS MAY BE STABILIZED WITH TEMPORARY AND/OR PERMANENT VEGETATIVE COVER. ALL OPEN AREAS THAT ARE TO REMAIN IDLE THROUGHOUT THE WINTER SHALL RECEIVE TEMPORARY EROSION CONTROL MEASURES INCLUDING TEMPORARY SEEDING, MULCHING AND/OR EROSION CONTROL BLANKET PRIOR TO THE END OF THE FALL GROWING SEASON. THE AREAS TO BE WORKED BEYOND THE END OF THE GROWING SEASON MUST INCORPORATE SOIL STABILIZATION MEASURES THAT DO NOT RELY ON VEGETATIVE COVER SUCH AS EROSION CONTROL BLANKET AND HEAVY MULCHING.
16. PERMANENT STABILIZATION SHALL BE COMPLETED WITHIN 7 DAYS FOR AREAS WHERE WORK IS COMPLETED.

CONTRACTOR CERTIFICATION STATEMENT

THIS CERTIFICATION STATEMENT IS A PART OF THE STORM WATER POLLUTION PREVENTION PLAN FOR THE PROJECT DESCRIBED BELOW IN ACCORDANCE WITH NPDES PERMIT NO. ILR10 ISSUED BY THE ILLINOIS ENVIRONMENTAL PROTECTION AGENCY.

PROJECT INFORMATION:

ROUTE: CHICAGO EXECUTIVE AIRPORT MARKED: REHABILITATE RUNWAY 16/34
SECTION: 13 PROJECT NUMBER: PWK-4414
COUNTY: COOK CONTRACT NUMBER: 3-17-SBGP-XX (PAOXX)

I CERTIFY UNDER PENALTY OF LAW THAT I UNDERSTAND THE TERMS AND CONDITIONS OF THE GENERAL NATIONAL POLLUTION DISCHARGE ELIMINATION SYSTEM (NPDES) PERMIT (ILR10) THAT AUTHORIZES THE STORM WATER DISCHARGES ASSOCIATED WITH INDUSTRIAL ACTIVITY FROM THE CONSTRUCTION SITE IDENTIFIED AS PART OF THIS CERTIFICATION.

SIGNATURE: _____ DATE: _____
PRINTED NAME: _____ TITLE: _____
NAME OF FIRM: _____
STREET ADDRESS: _____
CITY, STATE, ZIP: _____
PHONE NUMBER: _____

THE INFORMATION WITHIN THIS BOX SHALL BE COMPLETED BY THE CONTRACTOR AFTER THE AWARD OF THE CONTRACT TO OBTAIN THE REQUIRED NPDES PERMIT FROM IEPA. COMPLETION OF THIS IS A CONTRACT REQUIREMENT.

RECORD OF SITE DISTURBANCE AND STABILIZATION

MAJOR GRADING ACTIVITIES: LOCATION: _____	BEGINNING DATE: _____ COMPLETION DATE: _____
MAJOR GRADING ACTIVITIES: LOCATION: _____	BEGINNING DATE: _____ COMPLETION DATE: _____
SITE STABILIZATION: LOCATION: _____	BEGINNING DATE: _____ COMPLETION DATE: _____
SITE STABILIZATION: LOCATION: _____	BEGINNING DATE: _____ COMPLETION DATE: _____
CONSTRUCTION CEASED: EXPLANATION: _____	BEGINNING DATE: _____ COMPLETION DATE: _____

THE INFORMATION WITHIN THIS BOX SHALL BE COMPLETED BY THE CONTRACTOR AS CONSTRUCTION PROGRESSES IN ACCORDANCE WITH THE NPDES GENERAL PERMIT FOR STORMWATER DISCHARGES. THIS INFORMATION MAY ALSO BE NOTED DIRECTLY ON THE SWPPP SITE MAP.

NPDES PERMIT # _____
DATE ISSUED _____
DATE EXPIRED _____

IL. CONTRACT: **PA059**
IL. LETTING ITEM: **18A**
IL. PROJECT: **PWK-4414**
S.B.G. PROJECT: **3-17-SBGP-XX**

SURVEY BOOK # 1302

REVISIONS		
NUMBER	BY	DATE

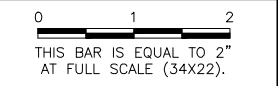

**CHICAGO EXECUTIVE AIRPORT
WHEELING/PROSPECT HEIGHTS, ILLINOIS
REHABILITATE RUNWAY 16/34**

**STORMWATER POLLUTION PREVENTION PLAN
NOTES AND DETAILS SHEET 1**

© Copyright CMT, Inc.

CMT
CRAWFORD, MURPHY & TILLY, INC.
CONSULTING ENGINEERS
License No. 184-000613

CHICAGO EXECUTIVE AIRPORT

DESIGN BY:	SMS
DRAWN BY:	JRO
CHECKED BY:	SMS
APPROVED BY:	DKP
DATE:	06/19/2015
JOB No:	14290-05-00

FINAL

KREF DWG: bchnt_rumovj.dwg

IMAGE FILES: IUM-5148C.dwg
IUM-620A.dwg
IUM-620B(A).dwt
pwknewLOGO_CEA-4-Color-Small (2).jpg

UPDATE BY: Sean Smith
LAYOUT: 14 SWPPP.DETS

DATE: Thursday, July 9, 2015 09:28:21
FILE: K:\Chicago\resg\14290-05_Rehab\SW16-5A\Draw\Sheets\14_SWPPP.DETS.dwg

IPP Flexstorm Inlet Filter Specifications			
Material Property	Test Method	Value (min ave)	
> Inner Filter Bag Specs (2 ft³ min vol)			
Grab Tensile	ASTM D 4632	100 lbs	200 lbs
Puncture Strength	ASTM D 4833	65 lbs	90 lbs
Trapezoidal Tear	ASTM D 4533	45 lbs	75 lbs
UV Resistance	ASTM D 4355	70% at 500 hrs	90%
App Open Size (AOS)	ASTM D 4751	70 sieve (.212 mm)	40 sieve (.425 mm)
Permittivity	ASTM D 4491	2.0 /sec	2.1/sec
Water Flow Rate	ASTM D 4491	145 gpm/sqft	145 gpm/sqft
> Polyester Outer Reinforcement Bag Specifications			
Weight	ASTM D 3776	4.55 oz/sqyd +/- 15%	
Thickness	ASTM D 1777	.040 +/- .005	
> Frame Construction			
A36 Structural Steel; 11 Gauge; Zinc Plated	ASTM A 576	Tensile Strength > 58,000 psi; Yield Strength > 36,000 psi	

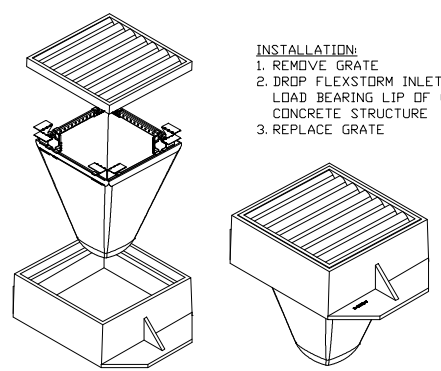
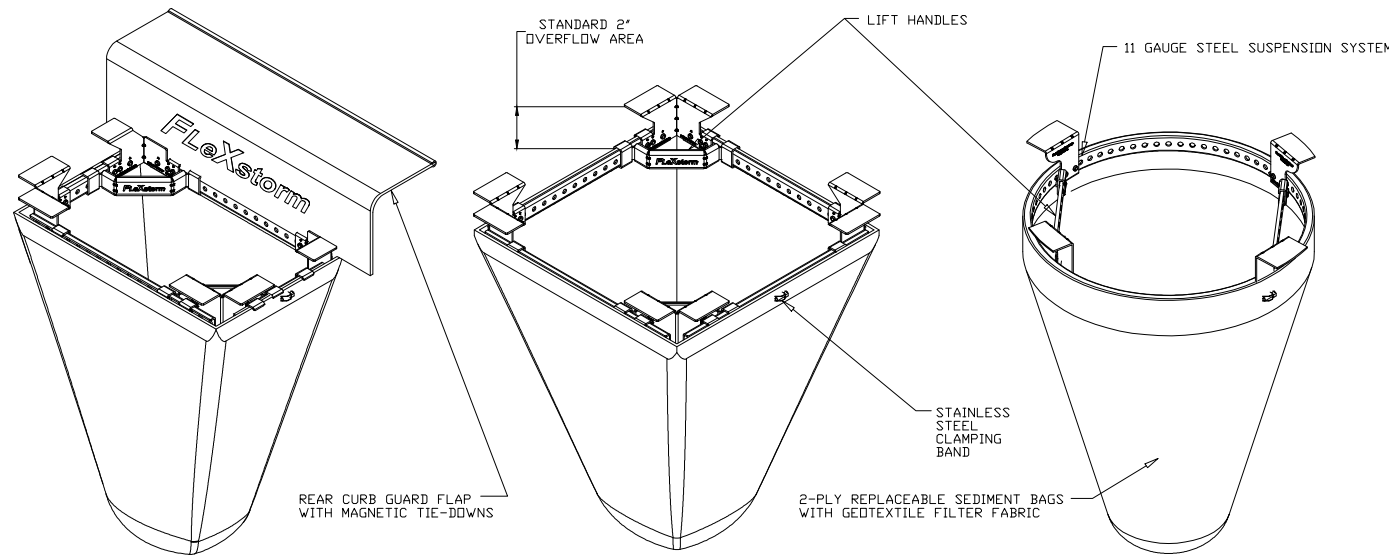

- INSTALLATION:**
1. REMOVE GRATE
 2. DROP FLEXSTORM INLET FILTER ONTO LOAD BEARING LIP OF CASTING OR CONCRETE STRUCTURE
 3. REPLACE GRATE

TYPICAL CURB BOX INLET FILTER
TYPICAL FLAT/RECTANGULAR/ROLLED CURB INLET FILTER
TYPICAL ROUND INLET FILTER

INLET PROTECTION / SEDIMENT TRAP

- NOT TO SCALE
1. STORM SEWER INLET PROTECTION SHALL BE FLEXSTORM INLET FILTERS AS DETAILED HEREIN OR APPROVED EQUAL
 2. ONLY THOSE INLET PROTECTIONS SHOWN ON THE STORM WATER POLLUTION PREVENTION PLAN SHALL BE PAID UNDER AR156520, INLET PROTECTION. INLET PROTECTIONS REQUIRED DUE TO CONTRACTOR REQUIREMENTS AT THE STAGING AREA SHALL BE CONSIDERED INCIDENTAL TO THE CONTRACT.

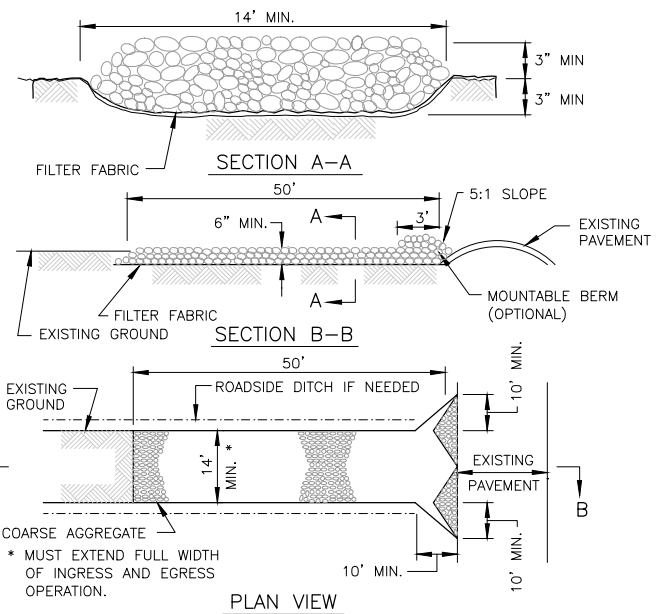

1. FILTER FABRIC SHALL MEET THE REQUIREMENTS OF MATERIAL SPECIFIED FOR AR152540 IN THE ILLINOIS DEPARTMENT OF TRANSPORTATION DIVISION OF AERONAUTICS SUPPLEMENTAL SPECIFICATIONS AND RECURRING SPECIAL PROVISIONS.
2. ROCK OR RECLAIMED CONCRETE SHALL MEET ONE OF THE FOLLOWING IDOT COARSE AGGREGATE GRADATION, CA-1, CA-2, CA-3 OR CA-4.
3. ANY DRAINAGE FACILITIES REQUIRED BECAUSE OF WASHING SHALL BE CONSTRUCTED ACCORDING TO MANUFACTURERS SPECIFICATIONS AND SHALL BE INCIDENTAL TO THE CONTRACT.
4. MINIMUM WIDTH IS 14' FOR ONE-WAY TRAFFIC AND 20' FOR TWO WAY TRAFFIC. TWO-WAY TRAFFIC WIDTHS SHALL BE INCREASED A MINIMUM OF 4' FOR TRAILER TRAFFIC. DEPENDING ON THE TYPE OF VEHICLE OR EQUIPMENT, SPEED, LOADS, CLIMATIC AND OTHER CONDITIONS UNDER WHICH VEHICLES AND EQUIPMENT OPERATE AN INCREASE IN THE MINIMUM WIDTHS MAY BE REQUIRED.
5. ROADWAY SHALL FOLLOW THE CONTOUR OF THE NATURAL TERRAIN TO THE EXTENT POSSIBLE.
6. STABILIZED CONSTRUCTION ENTRANCE(S) SHALL BE INCIDENTAL TO THE CONTRACT.

STABILIZED CONSTRUCTION ENTRANCE
FROM NRCS STANDARD DRAWING NO. IL-630 (MODIFIED)

IL CONTRACT: PA059
IL LETTING ITEM: 18A
IL PROJECT: PWK-4414
S.B.G. PROJECT: 3-17-SBGP-XX

SURVEY BOOK # 1302

REVISIONS

NUMBER	BY	DATE

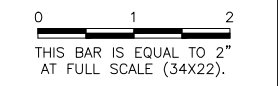

**CHICAGO EXECUTIVE AIRPORT
WHEELING/PROSPECT HEIGHTS, ILLINOIS
REHABILITATE RUNWAY 16/34**

**STORMWATER POLLUTION PREVENTION PLAN
NOTES AND DETAILS SHEET 2**

© Copyright CMT, Inc.

CMT
CRAWFORD, MURPHY & TILLY, INC.
CONSULTING ENGINEERS
License No. 184-000613

CHICAGO EXECUTIVE AIRPORT

DESIGN BY: SMS
DRAWN BY: JRO
CHECKED BY: SMS
APPROVED BY: DKP
DATE: 06/19/2015
JOB No: 14290-05-00

FINAL

ROLLED EROSION CONTROL PRODUCTS

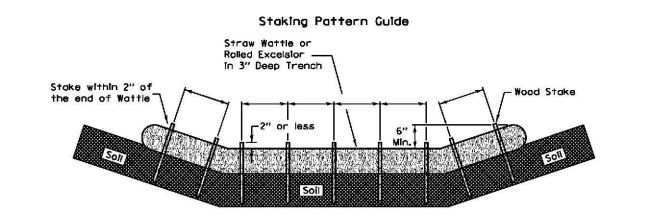

- Notes:**
1. Overlap minimum is the diameter of the roll.
 2. 4\" spacing for wattles.
 3. 2\" spacing for rolled excelsior.
 4. Or space according to manufacturer's specifications.

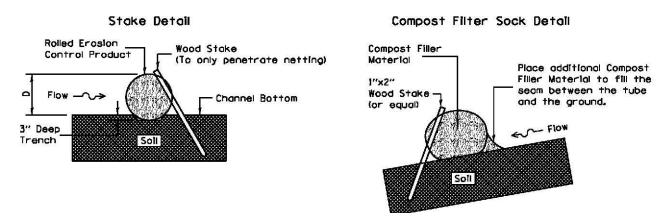

- Notes:**
1. Drawings are not to scale.
 2. Ends of wattles or rolled excelsior shall be turned at least 6\"/>
 - 3. Recommended stakes are 1 1/8\" wide x 1 1/8\" thick x 30\" long.
 - 4. Stakes shall not extend above the straw wattle more than 2\".
 - 5. Spacing: The toe of the upstream ditch check shall create a horizontal line with the top of the downstream ditch check.
 - 6. When compost filter sock ditch check is used, place a compost berm upstream of the filter sock (see IUM 805). A trench is not required.

PROJECT	DATE	STANDARD DWG. NO.
DESIGNED	DATE	IUM-514
CHECKED	DATE	SHEET 1 OF 1
APPROVED	DATE	DATE 6-19-11

SILT FENCE PLAN

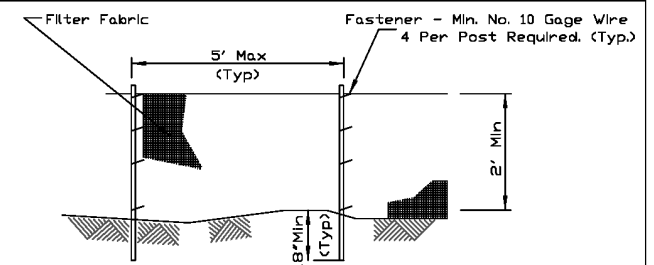

ELEVATION

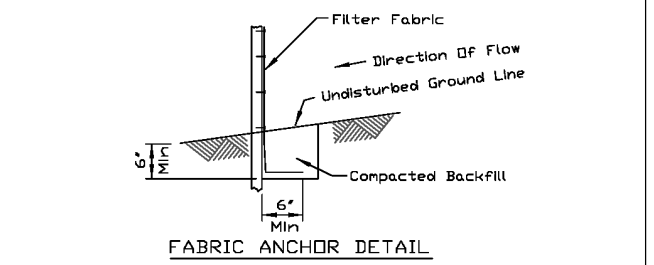

FABRIC ANCHOR DETAIL

- NOTES:**
1. Temporary sediment fence shall be installed prior to any grading work in the area to be protected. They shall be maintained throughout the construction period and removed in conjunction with the final grading and site stabilization.
 2. Filter fabric shall meet the requirements of material specification 592 Geotextile Table 1 or 2, Class I with equivalent opening size of at least 30 for nonwoven and 40 for woven, and Item 156 specifications
 3. Fence posts shall be either standard steel post or wood post with a minimum cross-sectional area of 3.0 sq. in.

PROJECT	DATE	STANDARD DWG. NO.
DESIGNED	DATE	IUM-620A
CHECKED	DATE	SHEET 1 OF 2
APPROVED	DATE	DATE 3-16-12

SILT FENCE - SPLICING TWO FENCES

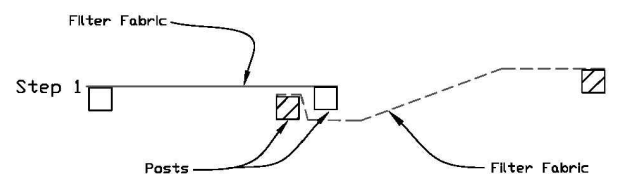

ATTACHING TWO SILT FENCES

1. Place the end post of the second fence inside the end post of the first fence.
2. Rotate both posts at least 180 degrees in a clockwise direction to create a tight seal with the fabric material.
3. Cut the fabric near the bottom of the stakes to accommodate the 6\"/>
- 4. Drive both posts a minimum of 18 inches into the ground and bury the flap.
- 5. Compact backfill (particularly at splices) completely to prevent stormwater piping.

PROJECT	DATE	STANDARD DWG. NO.
DESIGNED	DATE	IUM-620B(CW)
CHECKED	DATE	SHEET 1 OF 1
APPROVED	DATE	DATE 3-16-2012

STAGING AREA PROTECTION NOTES:

1. THE CONTRACTOR SHALL BE REQUIRED TO PROVIDE STORM WATER POLLUTION PREVENTION DEVICES AT THE STAGING AREA. THESE DEVICES, INCLUDING INLET PROTECTIONS, SILT FENCE, BALES, DITCH CHECKS, STABILIZED CONSTRUCTION ENTRANCES, ETC., SHALL NOT BE PAID FOR, BUT SHALL BE CONSIDERED INCIDENTAL TO THE CONTRACT.
2. AT THE COMPLETION OF WORK, THE STAGING AREA SHALL BE RESTORED TO PRE-CONSTRUCTION CONDITIONS, AT NO ADDITIONAL COST TO THE CONTRACT. THIS WORK SHALL INCLUDE REMOVING ANY AND ALL STORM WATER POLLUTION PREVENTION DEVICES, RESTORING RUTTED AREAS, SEEDING AND MULCHING.
3. IT IS THE CONTRACTOR'S RESPONSIBILITY TO MAINTAIN THE STAGING AREA(S) IN A MANNER TO PREVENT POLLUTION AND SILTATION OF THE EXISTING STORM SEWER SYSTEM.

DATE: Thursday, July 9, 2015 09:28:43
 FILE: K:\ChicagoExecAirp\14290-05_RehabRWY16-34(Draw) Sheets\15_RWY_TYP_SECTS.dwg
 UPDATE BY: Sean Smith
 LAYOUT: RWY_TYP_SECTS
 IMAGE FILES: pmkrnewLOGO_CEA-4-Color-Small (2).jpg
 REF DWG: runway_16-34_base.dwg
 techn_runway.dwg

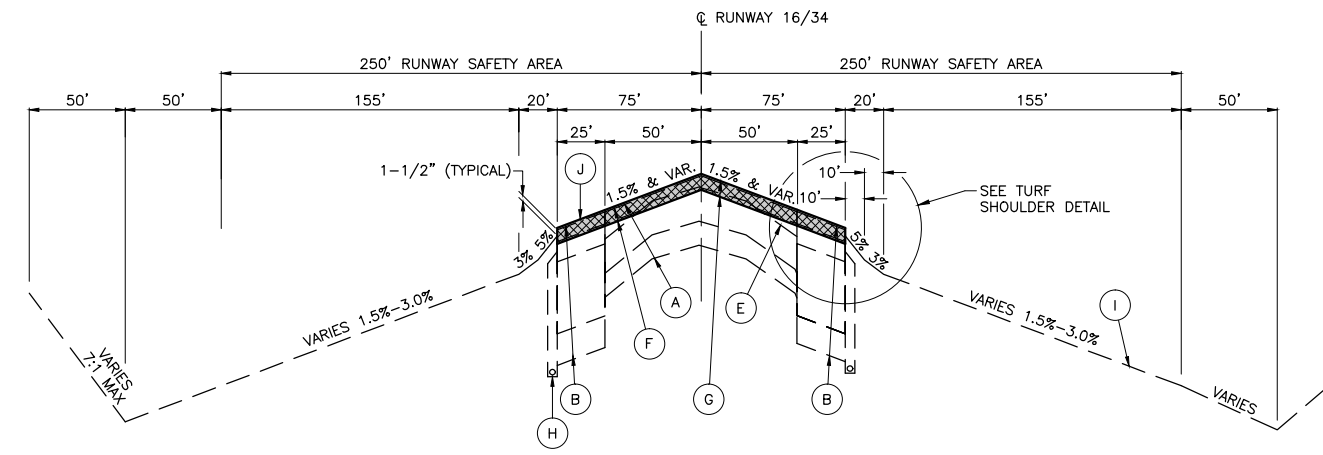

RUNWAY 16/34 TYPICAL SECTION A-A

34 END TO STA. 613+50
NOT TO SCALE

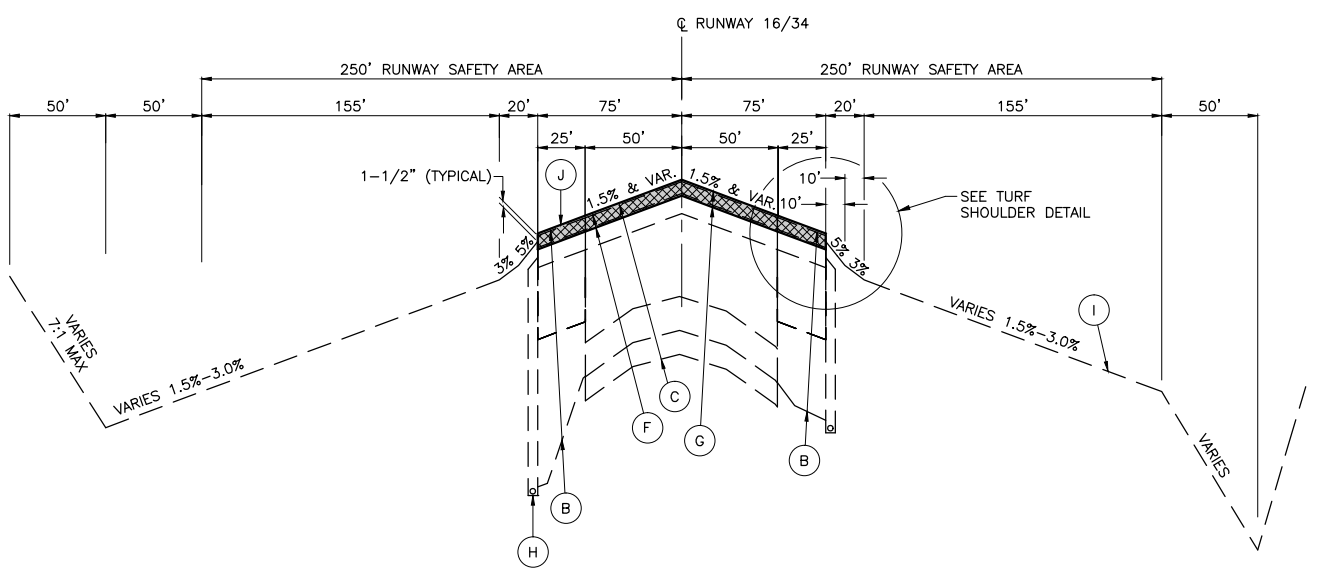

RUNWAY 16/34 TYPICAL SECTION B-B

STA. 613+50 TO STA. 637+25
NOT TO SCALE

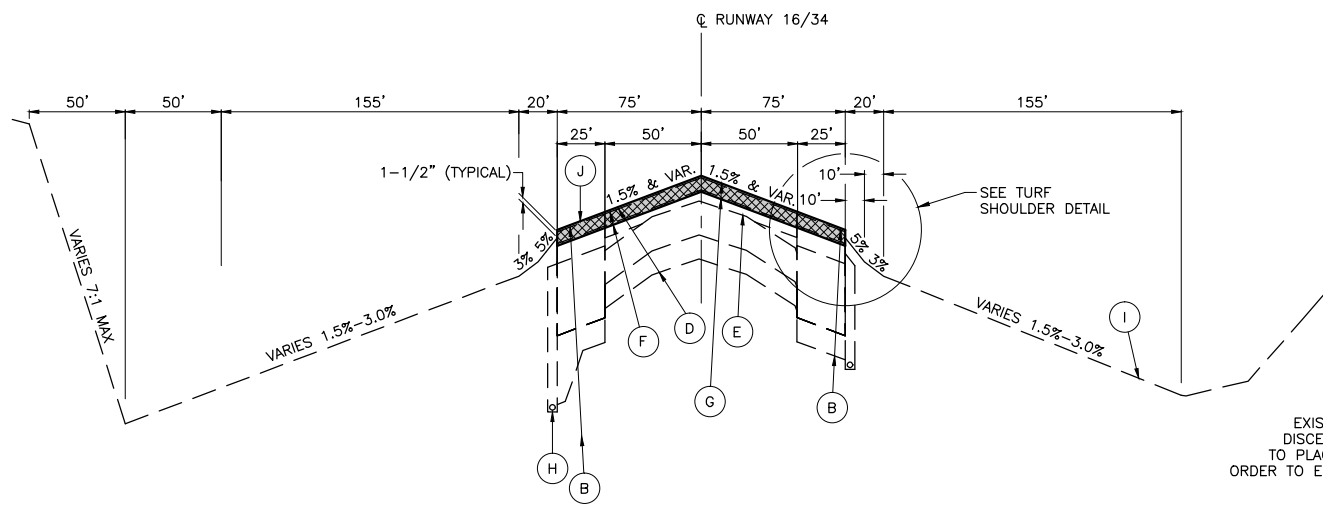

RUNWAY 16/34 TYPICAL SECTION C-C

STA. 637+25 TO 16 END
NOT TO SCALE

LEGEND

- (A) EXISTING 13" BITUMINOUS PAVEMENT (401/403)
EXISTING 6" CRUSHED AGGREGATE BASE COURSE (209)
- (B) EXISTING 8" BITUMINOUS PAVEMENT (401/201)
EXISTING 18" CRUSHED AGGREGATE BASE COURSE (209)
EXISTING 6" AND VARIABLE POROUS GRANULAR EMBANKMENT (208)
- (C) EXISTING 22.5" BITUMINOUS PAVEMENT (401/201)
EXISTING 6" CRUSHED AGGREGATE BASE COURSE (209)
- (D) EXISTING 14.5" BITUMINOUS PAVEMENT (401/403)
EXISTING 6" CRUSHED AGGREGATE BASE COURSE (209)
- (E) EXISTING REFLECTIVE CRACK CONTROL - SYSTEM A (STRIP FABRIC)
- (F) BITUMINOUS PAVEMENT MILLING (3" - 4") (401650)
- (G) NEW 4" BITUMINOUS SURFACE COURSE (401)
IN 2-2" LIFTS (TACK COAT BEFORE FIRST LIFT AND BETWEEN LIFTS)
- (H) EXISTING 6" CPPUP W/ SOCK, FILTER FABRIC ENVELOPE AND POROUS BACKFILL (705)
- (I) EXISTING GROUNDLINE
- (J) NEW BITUMINOUS PAVEMENT GROOVING (401640)

NOTES

1. ONLY THE AREA THAT CAN BE COVERED WITH ONE LIFT OF BITUMINOUS SURFACE COURSE (2" AND VARIABLE) PRIOR TO REOPENING THE RUNWAY SHALL BE MILLED DURING EACH CLOSURE PERIOD. MILLED SURFACE SHALL NOT BE AN ACCEPTABLE SURFACE WHEN THE RUNWAY IS OPEN.
2. AFTER MILLING IS COMPLETE, THE AREA SHALL BE THOROUGHLY CLEANED. ALL CRACKS LESS THAN 1" WIDE SHALL BE CLEANED AND SEALED. CRACKS LARGER THAN 1" WIDE SHALL BE CLEANED AND REPAIRED WITH SAND MIX. SEE DETAILS ON TAXIWAY TYPICAL SECTIONS SHEET.
3. THE SECOND LIFT OF BITUMINOUS SURFACE COURSE (2") SHALL BE PLACED IN NO MORE THAN THREE SECTIONS ALONG THE LENGTH OF THE RUNWAY. FULL WIDTH JOINTS SHALL BE SAWED AND SEALED.
4. THE JOINT BETWEEN NEW AND EXISTING BITUMINOUS PAVEMENT SHALL BE SAWED AND SEALED (PROJECT LIMITS), COST INCLUDED IN BITUMINOUS SURFACE COURSE.
5. THE JOINT BETWEEN NEW BITUMINOUS AND EXISTING PCC PAVEMENTS SHALL BE SAWED AND SEALED, COST INCLUDED IN BITUMINOUS SURFACE COURSE.

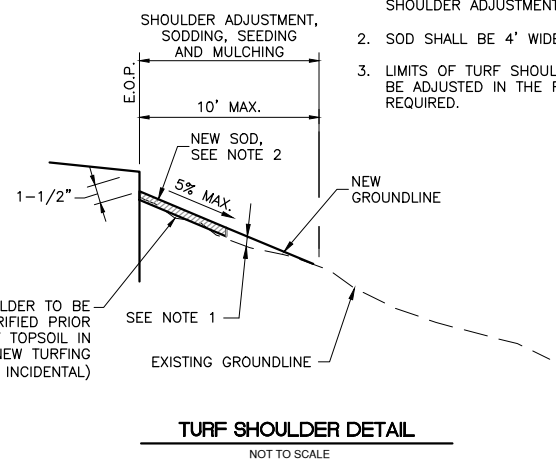

EXISTING SHOULDER TO BE DISCED OR SCARIFIED PRIOR TO PLACEMENT OF TOPSOIL IN ORDER TO ESTABLISH NEW TURFING (COST INCIDENTAL)

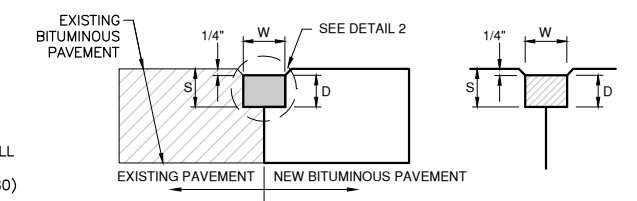
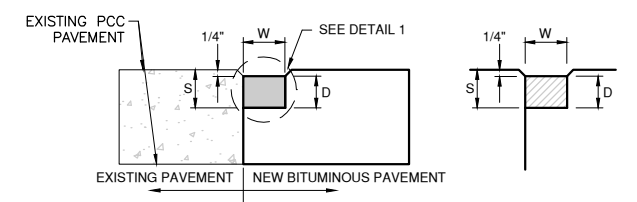
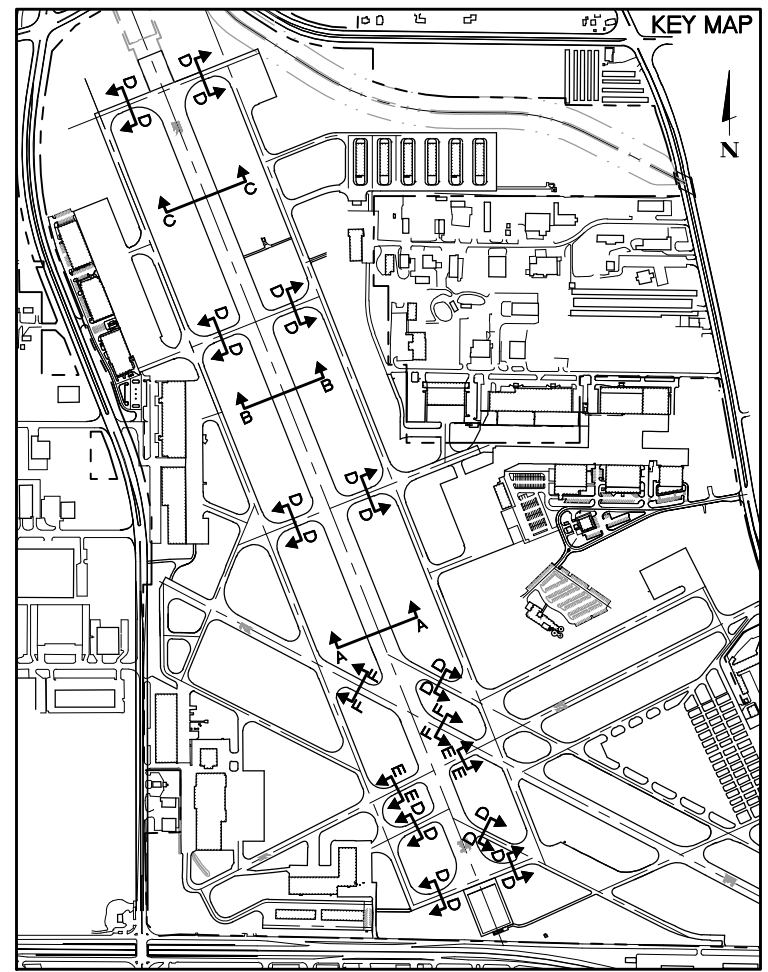

	DETAIL 1 AND 2	
	HOT/COLD POUR	SILICONE
W=WIDTH OF SEALANT RESERVOIR (IN.)	2	3/8
D=DEPTH OF SEALANT RESERVOIR (IN.)	2	1/4
B=BACKER ROD DIAMETER (IN.)	2	N/A
S=SECOND SAWCUT DEPTH (IN.) MINIMUM	3/4	1/2

NOTE: JOINT SEALING SHALL BE PER SECTION 605 OF SPECIAL PROVISIONS.

NOTES:

1. TOPSOIL REQUIRED FOR FILL SHALL BE INCLUDED IN THE COSTS FOR SHOULDER ADJUSTMENT (AR152480)
2. SOD SHALL BE 4' WIDE.
3. LIMITS OF TURF SHOULDER SHALL BE ADJUSTED IN THE FIELD AS REQUIRED.

I.L. CONTRACT: PA059
 I.L. LETTING ITEM: 18A
 I.L. PROJECT: PWK-4414
 S.B.G. PROJECT: 3-17-SBGP-XX

SURVEY BOOK # 1302

REVISIONS

NUMBER	BY	DATE

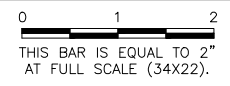

**CHICAGO EXECUTIVE AIRPORT
 WHEELING/PROSPECT HEIGHTS, ILLINOIS
 REHABILITATE RUNWAY 16/34**

**TYPICAL SECTIONS
 RUNWAY 16/34**

© Copyright CMT, Inc.



CRAWFORD MURPHY & TILLY, INC.
 CONSULTING ENGINEERS
 License No. 184-000613



DESIGN BY: SMS
 DRAWN BY: JRO
 CHECKED BY: SMS
 APPROVED BY: DKP
 DATE: 06/19/2015
 JOB No: 14290-05-00

FINAL

DATE: Thursday, July 9, 2015, 09:29:03
 FILE: K:\Chicago\Recon\14290-05-Rehab\16-34\Draw\Sheets\16-TX-TYP-SECTS.dwg
 UPDATE BY: Sean Smith
 LAYOUT: TX-TYP-SECTS
 REF DWG: runway_16-34_base.dwg
 bchm_runway.dwg
 IMAGE FILES: pmknewLOGO_CEA-4-Color-Small (2).jpg

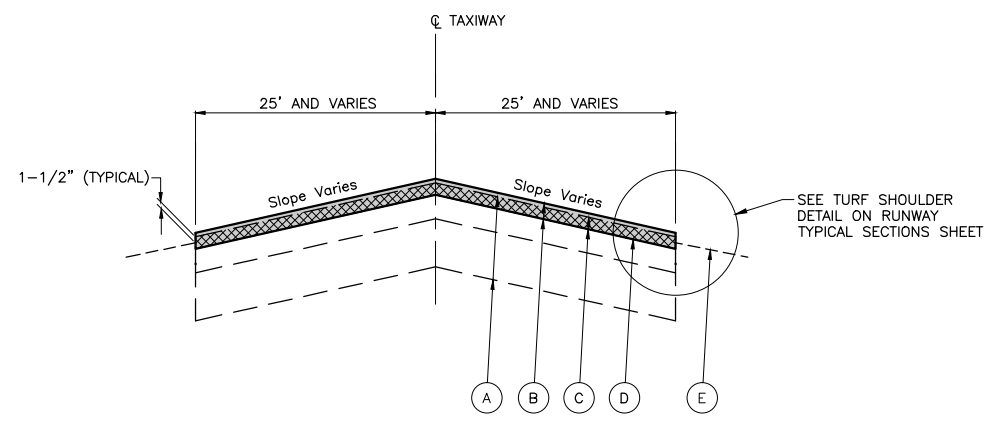

TAXIWAY TYPICAL SECTION D-D
NOT TO SCALE

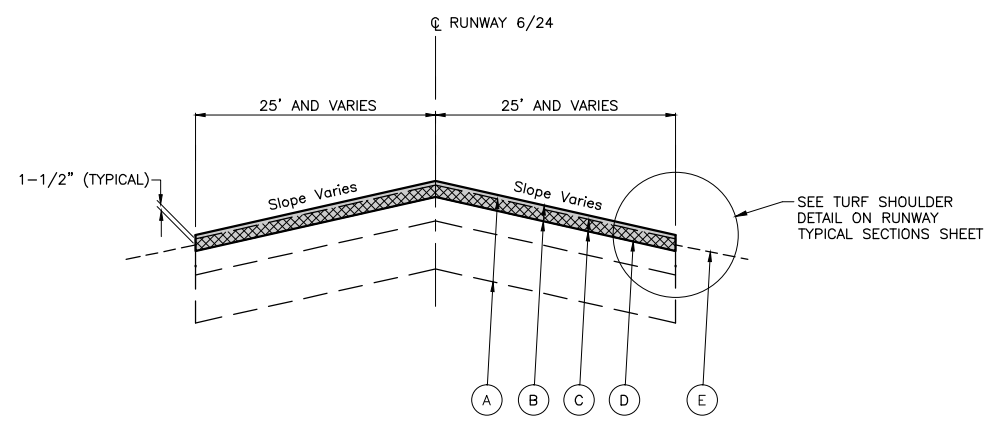

RUNWAY 6/24 TYPICAL SECTION E-E
NOT TO SCALE

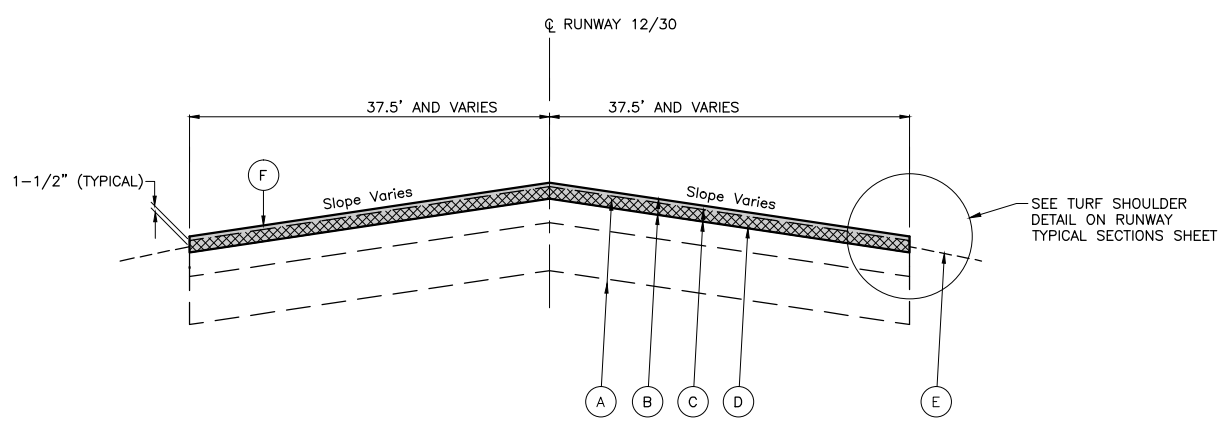

RUNWAY 12/30 TYPICAL SECTION F-F
NOT TO SCALE

LEGEND

- (A) EXISTING BITUMINOUS PAVEMENT (DEPTH VARIES) (401)
- (B) NEW 2" BITUMINOUS SURFACE COURSE (401)
- (C) BUTT JOINT CONSTRUCTION (AR401655)
- (D) NEW BITUMINOUS TACK COAT (AR603510)
- (E) EXISTING GROUNDLINE
- (F) NEW BITUMINOUS PAVEMENT GROOVING (401650)

NOTES

1. MILLED SURFACE SHALL NOT BE AN ACCEPTABLE SURFACE WHEN THE RUNWAY IS OPEN. ALL BUTT JOINTS SHALL BE PAVED PRIOR TO REOPENING THE RUNWAY.
2. AFTER BUTT JOINT CONSTRUCTION IS COMPLETE, THE AREA SHALL BE THOROUGHLY CLEANED. ALL CRACKS LESS THAN 1" WIDE SHALL BE CLEANED AND SEALED. CRACKS LARGER THAN 1" WIDE SHALL BE CLEANED AND REPAIRED WITH SAND MIX.
3. THE JOINT BETWEEN NEW AND EXISTING BITUMINOUS PAVEMENT SHALL BE SAWED AND SEALED (PROJECT LIMITS), COST INCLUDED IN BITUMINOUS SURFACE COURSE. SEE DETAIL ON RUNWAY TYPICAL SECTIONS SHEET.
4. THE JOINT BETWEEN NEW BITUMINOUS AND EXISTING PCC PAVEMENTS SHALL BE SAWED AND SEALED, COST INCLUDED IN BITUMINOUS SURFACE COURSE. SEE DETAIL ON RUNWAY TYPICAL SECTIONS SHEET.

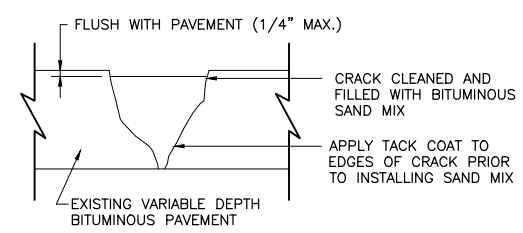

HMA SAND MIX CRACK REPAIR DETAIL
NOT TO SCALE

CRACK REPAIR NOTES:

1. CRACKS TO BE FILLED WITH SAND MIX SHALL BE DESIGNATED BY THE RESIDENT ENGINEER.
2. SAND MIX CRACK REPAIR SHALL BE USED ON ALL CRACKS GREATER THAN 1" WIDE AS DESIGNATED BY THE RESIDENT ENGINEER.
3. CONTRACTOR SHALL ROUT, CRACK PLOW AND REMOVE LOOSE FILLER, LOOSE AGGREGATE AND LAITANCE WITH COMPRESSED AIR AS SPECIFIED PRIOR TO SEALING.

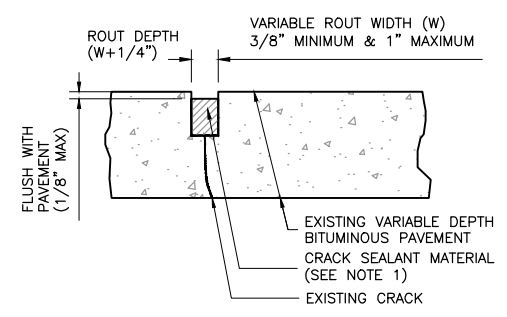

CLEAN AND SEAL BITUMINOUS CRACKS (AR201661)
NOT TO SCALE

CRACK SEALING NOTES:

1. THE CRACK ROUTING DIMENSIONS WILL PROVIDE A WIDTH TO DEPTH RATIO OF 1:1 FOR SEALANT MATERIAL.
2. CRACKS TO BE ROUTED, CLEANED AND SEALED AT LOCATIONS DESIGNATED BY THE RESIDENT ENGINEER.

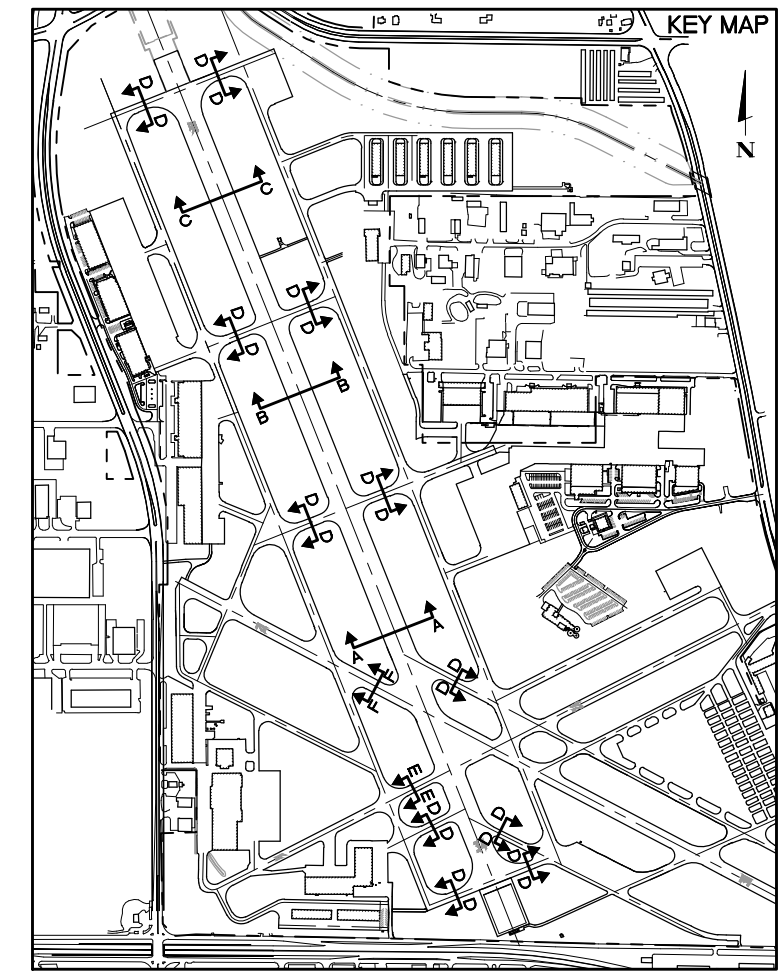

IL CONTRACT: PA059
 IL LETTING ITEM: 18A
 IL PROJECT: PWK-4414
 S.B.G. PROJECT: 3-17-SBGP-XX

SURVEY BOOK # 1302

REVISIONS

NUMBER	BY	DATE

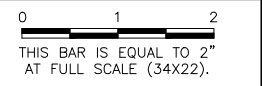

CHICAGO EXECUTIVE AIRPORT
WHEELING/PROSPECT HEIGHTS, ILLINOIS
REHABILITATE RUNWAY 16/34
TYPICAL SECTIONS - ALL TAXIWAYS
AND RUNWAYS 6/24 AND 12/30

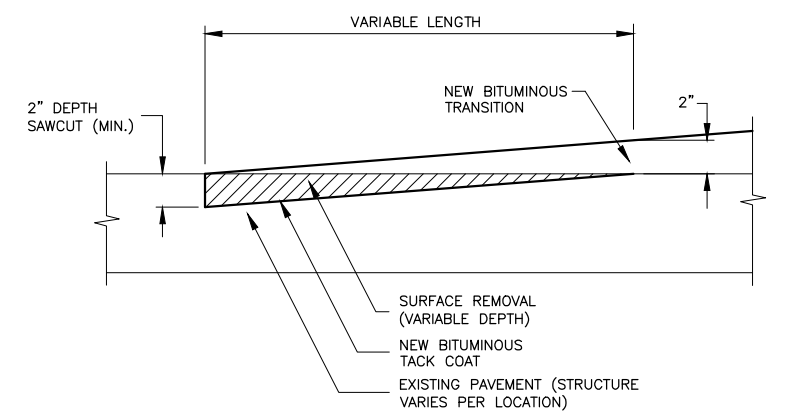

BUTT JOINT DETAIL (AR401655)
NOT TO SCALE



















































© Copyright CMT, Inc.
CMT
 CRAWFORD MURPHY & TILLY, INC.
 CONSULTING ENGINEERS
 License No. 184-000613
CHICAGO EXECUTIVE AIRPORT

DESIGN BY:	SMS
DRAWN BY:	JRO
CHECKED BY:	SMS
APPROVED BY:	DKP
DATE:	06/19/2015
JOB No:	14290-05-00

FINAL

DATE: Thursday, July 9, 2015, 09:29:46
 FILE: K:\Chicago\resep\14290-05-RelatRWY16-34\Draw\Sheets\17-21 EXST COND.dwg
 UPDATE BY: Sean Smith
 LAYOUT: EX COND 1
 XREF DWG: bchnt_ranway.dwg
 C:\Users\sean.smith\OneDrive\Documents\14290-05-RelatRWY16-34\Draw\Sheets\17-21 EXST COND.dwg
 IMAGE FILES: pwknewLOGO_CEA-4-Color-Small (2).jpg

LEGEND

-  EXISTING BASE MOUNTED MEDIUM INTENSITY TAXIWAY LIGHT
-  EXISTING STAKE MOUNTED MEDIUM INTENSITY TAXIWAY LIGHT
-  EXISTING BASE MOUNTED HIGH INTENSITY RUNWAY LIGHT
-  EXISTING STAKE MOUNTED HIGH INTENSITY RUNWAY LIGHT
-  EXISTING IN PAVEMENT MOUNTED HIGH INTENSITY RUNWAY LIGHT
-  EXISTING ELEVATED RETROREFLECTIVE MARKER
-  EXISTING VISUAL APPROACH SLOPE INDICATOR (VASI)
-  EXISTING RUNWAY END IDENTIFIER LIGHT (REIL)
-  EXISTING APPROACH LIGHTING SYSTEM
-  EXISTING AIRFIELD GUIDANCE SIGN
-  EXISTING WINDCONE
-  EXISTING WINDCONE WITH SEGMENTED CIRCLE
-  EXISTING ELECTRICAL TRANSFORMER
-  EXISTING ELECTRICAL/STORM/SANITARY/TELEPHONE MANHOLE OR EXISTING WATER VALVE VAULT
-  EXISTING ELECTRICAL HANDHOLE
-  EXISTING STORM INLET
-  EXISTING SLOPE BOX
-  EXISTING FLARED END SECTION
-  EXISTING HEADWALL
-  EXISTING CLEANOUT STRUCTURE
-  EXISTING FLUSH MOUNTED FIRE HYDRANT
-  EXISTING WATER VALVE
-  EXISTING UTILITY PEDESTAL
-  EXISTING CONDUIT/DUCT BANK
-  EXISTING RUNWAY 16/34 CIRCUIT
-  EXISTING RUNWAY 12/30 CIRCUIT
-  EXISTING RUNWAY 6/24 CIRCUIT
-  EXISTING RUNWAY 16 APPROACH LIGHTING CIRCUIT
-  EXISTING TAXIWAY G AND D CIRCUIT
-  EXISTING TAXIWAY D, L, M, N, Y AND Z CIRCUIT
-  EXISTING TAXIWAY A, B, E AND F CIRCUIT
-  EXISTING TAXIWAY KILO CIRCUIT
-  EXISTING TAXIWAY HFC CIRCUIT
-  EXISTING REIL CABLES
-  EXISTING VASI CABLES
-  EXISTING FAA CABLES
-  EXISTING COMED SERVICE TO FAA ILS SYSTEM
-  EXISTING FAA WIND INSTRUMENT CABLES
-  EXISTING PRIESTER AVIATION CABLES
-  EXISTING STORM SEWER
-  EXISTING UNDERDRAIN
-  EXISTING WATERMAIN
-  EXISTING SANITARY SEWER
-  EXISTING SEWER IN CASING PIPE
-  EXISTING TELEPHONE LINES
-  EXISTING CABLE TELEVISION LINES
-  EXISTING ITEM TO BE REMOVED
-  EXISTING ITEM TO BE REPLACED
-  PROPOSED BUTT JOINT CONSTRUCTION (AR401655)
-  PROPOSED 3'-4" BITUMINOUS PAVEMENT MILLING (AR401650)

NOTES

1. PRIOR TO PAVING OPERATIONS, THE FINAL MILLED SURFACE SHALL BE BROOMED CLEAN AND THE CONTRACTOR AND THE RESIDENT ENGINEER SHALL INSPECT THE FINAL SURFACE. ALL LOOSE PIECES SHALL BE REMOVED. ALL CRACKS FOUND TO BE WIDER THAN 1" SHALL BE REPAIRED UNDER ITEM AR201663, SAND MIX CRACK REPAIR. OTHER CRACKS AS NOTED DURING THE INSPECTION SHALL BE SEALED UNDER ITEM AR201661, CLEAN AND SEAL BITUMINOUS CRACKS
2. MILLING LIMITS HAVE BEEN ESTABLISHED AS THE INTERFACE BETWEEN THE PCC AND HMA PAVEMENT.
3. EXISTING CABLE TO BE REPLACED SHALL BE REMOVED TO MAKE WAY FOR NEW CABLING, COSTS INCLUDED IN THE PAY ITEM FOR THE NEW CABLE. REMOVED CABLES SHALL BE DISPOSED OF OFF AIRPORT PROPERTY.
4. EXISTING DUCT MARKERS SHALL BE SURVEYED BY THE CONTRACTOR BEFORE SURFACE IS MILLED.

THE INFORMATION SHOWN ON THESE PLANS HAS BEEN OBTAINED FROM AVAILABLE RECORDS. NEITHER THE OWNER NOR THE ENGINEER ASSUMES ANY RESPONSIBILITY WHATSOEVER IN RESPECT TO THE ACCURACY OR SUFFICIENCY OF THE INFORMATION AND THERE IS NO GUARANTEE EITHER EXPRESSED OR IMPLIED THAT THE CONDITIONS INDICATED ARE REPRESENTATIVE OF THOSE TO BE ENCOUNTERED IN THE FIELD. IT SHALL BE THE CONTRACTOR'S RESPONSIBILITY TO VISIT THE SITE AND ACQUAINT HIMSELF WITH THE EXISTING CONDITIONS.

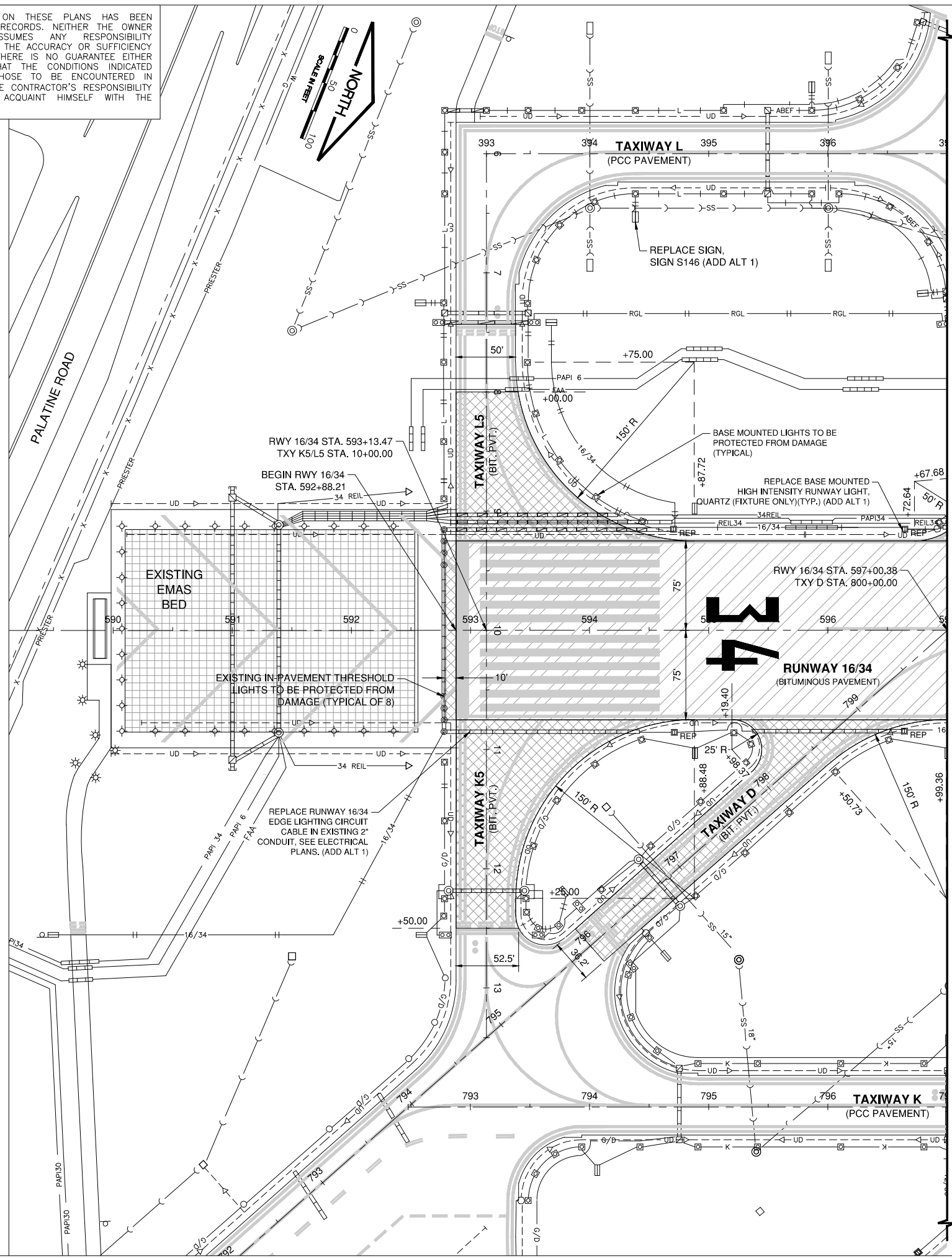
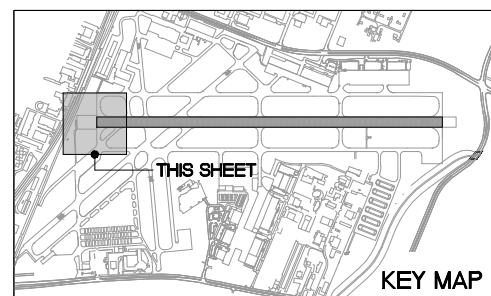

IL CONTRACT: **PA059**
 IL LETTING ITEM: **18A**
 IL PROJECT: **PWK-4414**
 S.B.G. PROJECT: **3-17-SBGP-XX**

SURVEY BOOK # 1302

REVISIONS		
NUMBER	BY	DATE

0 1 2
 THIS BAR IS EQUAL TO 2" AT FULL SCALE (34X22).

CHICAGO EXECUTIVE AIRPORT
WHEELING/PROSPECT HEIGHTS, ILLINOIS
REHABILITATE RUNWAY 16/34
EXISTING CONDITIONS AND PROPOSED REMOVALS SHEET 1

 **CMT**
 CRAWFORD, MURPHY & TILLY, INC.
 CONSULTING ENGINEERS
 License No. 184-000613



DESIGN BY:	SMS
DRAWN BY:	JRO
CHECKED BY:	SMS
APPROVED BY:	DKP
DATE:	06/19/2015
JOB No:	14290-05-00

FINAL

SHEET 17 OF 58 SHEETS

DATE: Thursday, July 9, 2015, 13:04:51
 FILE: K:\Chicago\edeg\14290-05_RetainRWY16-3A\Drawn\Sheets\17-21_EXST_COND.dwg
 UPDATE BY: Sean Smith
 LAYOUT: EX COND 2
 IMAGE FILES: pwknewlogo_gca-4-Color-Small (2).jpg
 KREF DWG: 16airt runway.dwg
 16airt runway.dwg
 CDR Alignments.dwg

SEE EXISTING CONDITIONS AND
 PROPOSED REMOVALS SHEET 1 FOR
 LEGEND AND GENERAL NOTES

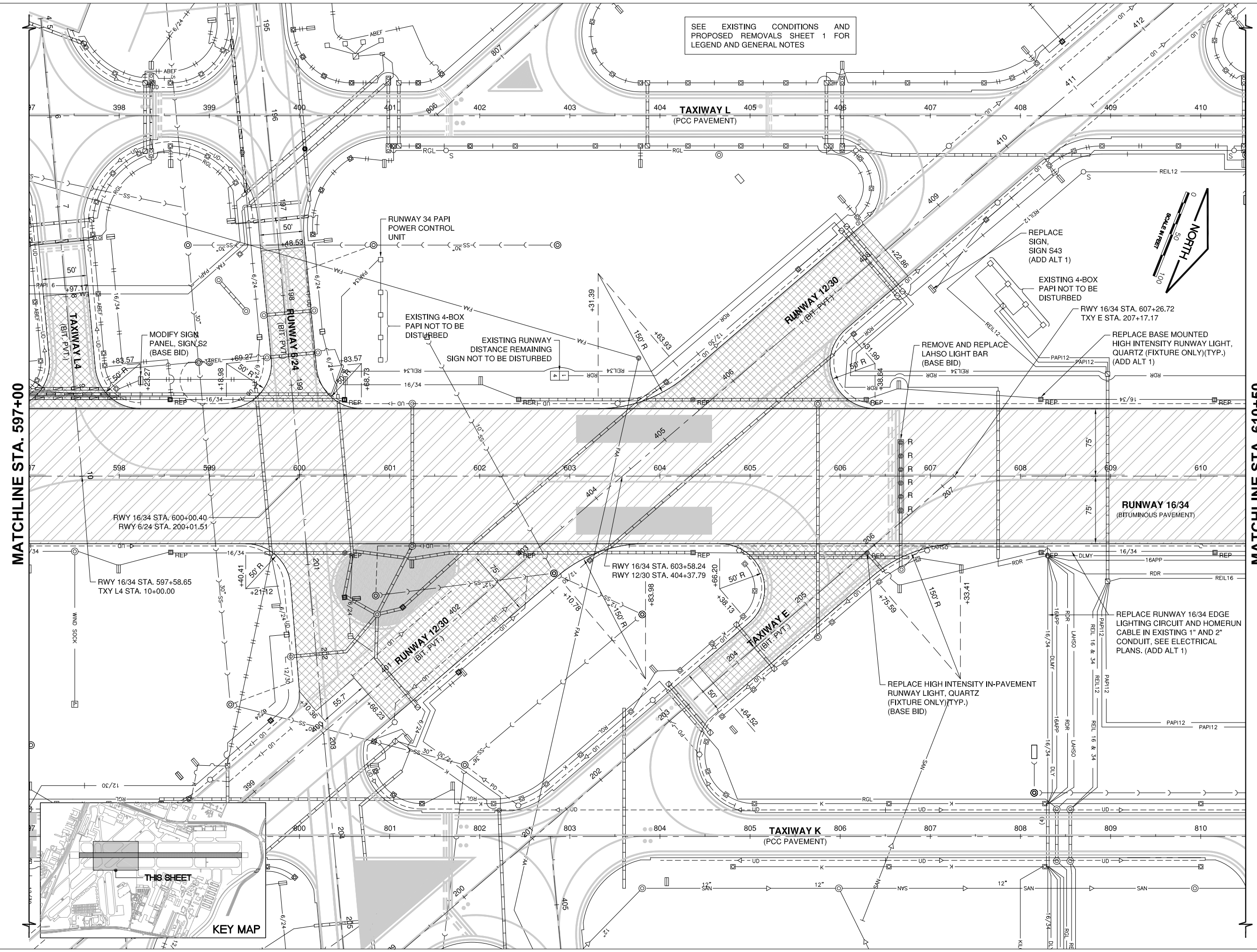

IL CONTRACT: PA059
 IL LETTING ITEM: 18A
 IL PROJECT: PWK-4414
 S.B.G. PROJECT: 3-17-SBGP-XX

SURVEY BOOK # 1302

REVISIONS		
NUMBER	BY	DATE

0 1 2
 THIS BAR IS EQUAL TO 2" AT FULL SCALE (34X22).

**CHICAGO EXECUTIVE AIRPORT
 WHEELING/PROSPECT HEIGHTS, ILLINOIS
 REHABILITATE RUNWAY 16/34**

**EXISTING CONDITIONS AND
 PROPOSED REMOVALS SHEET 2**

© Copyright CMT, Inc.

CMT
 CRAWFORD, MURPHY & TILLY, INC.
 CONSULTING ENGINEERS
 License No. 184-000613

CHICAGO EXECUTIVE AIRPORT

DESIGN BY:	SMS
DRAWN BY:	JRO
CHECKED BY:	SMS
APPROVED BY:	DKP
DATE:	06/19/2015
JOB No:	14290-05-00

FINAL

SHEET 18 OF 58 SHEETS

DATE: Thursday, July 9, 2015, 09:30:21
 FILE: K:\Chicago\Recep\14290-05_RehabRW16-34\Draw\Sheets\17-21_EXST_COND.dwg
 UPDATE BY: Sean Smith
 LAYOUT: EX_COND_3
 IMAGE FILES: pwknewLOGO_CEA-4-Color-Small (2).jpg
 KREF DWG: bchrl_ranway.dwg
 C:\Users\sean.smith\Documents\14290-05_RehabRW16-34\Draw\Sheets\17-21_EXST_COND.dwg

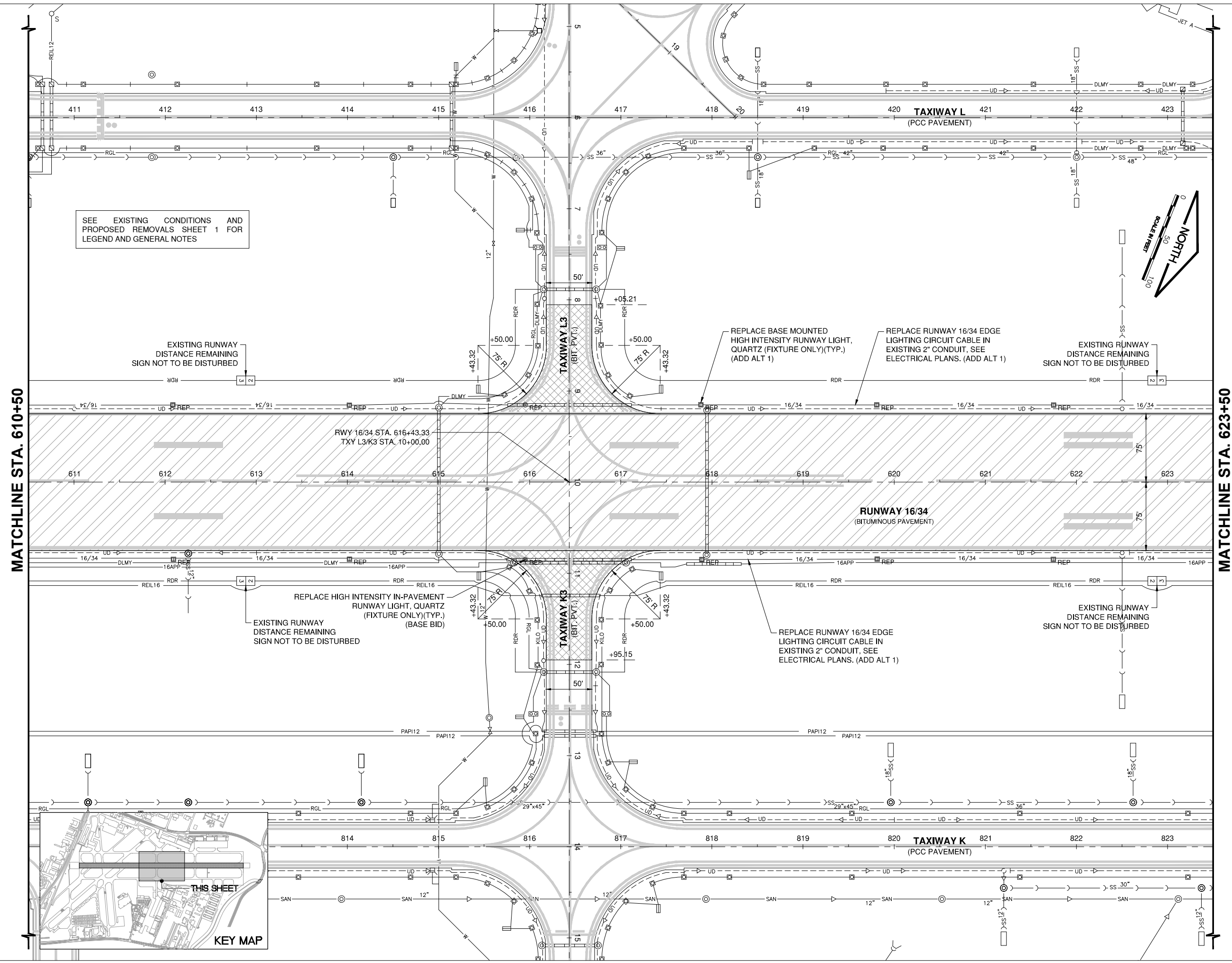

SEE EXISTING CONDITIONS AND PROPOSED REMOVALS SHEET 1 FOR LEGEND AND GENERAL NOTES

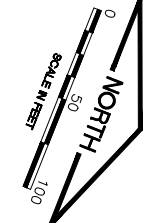

IL. CONTRACT: PA059
 IL. LETTING ITEM: 18A
 IL. PROJECT: PWK-4414
 S.B.G. PROJECT: 3-17-SBGP-XX

SURVEY BOOK # 1302

REVISIONS		
NUMBER	BY	DATE

CHICAGO EXECUTIVE AIRPORT
 WHEELING/PROSPECT HEIGHTS, ILLINOIS
 REHABILITATE RUNWAY 16/34

EXISTING CONDITIONS AND PROPOSED REMOVALS SHEET 3

© Copyright CMT, Inc.

CMT
 CRAWFORD, MURPHY & TILLY, INC.
 CONSULTING ENGINEERS
 License No. 184-000613

CHICAGO EXECUTIVE AIRPORT

DESIGN BY: SMS
 DRAWN BY: JRO
 CHECKED BY: SMS
 APPROVED BY: DKP
 DATE: 06/19/2015
 JOB No: 14290-05-00

FINAL

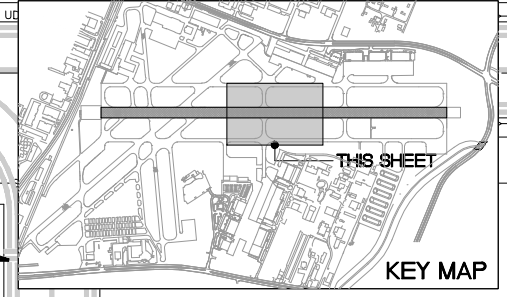

DATE: Thursday, July 9, 2015, 09:30:31
 FILE: K:\Chicago\Recon\14290-05_Rehab\RW16-34\Draw\Sheets\17-21_EXST_COND.dwg
 UPDATE BY: Sean Smith
 LAYOUT: EX COND 4
 IMAGE FILES: pwknewLOGO_CEA-4-Color-Small (2).jpg
 XREF DWG: bchrt runway.dwg
 C:\Users\sean.smith\Documents\14290-05_Rehab\RW16-34\Draw\Sheets\17-21_EXST_COND.dwg

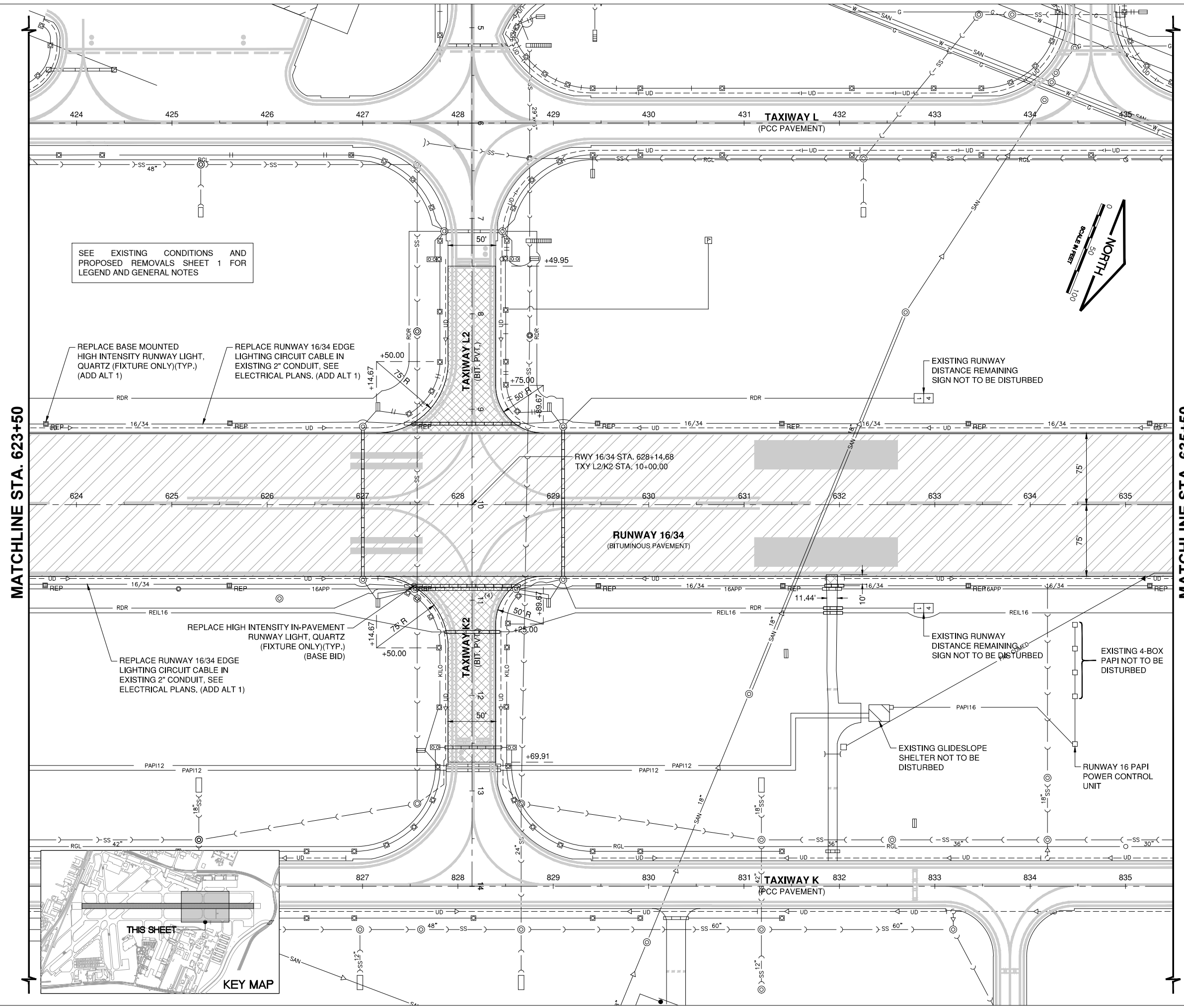

SEE EXISTING CONDITIONS AND PROPOSED REMOVALS SHEET 1 FOR LEGEND AND GENERAL NOTES

REPLACE BASE MOUNTED HIGH INTENSITY RUNWAY LIGHT, QUARTZ (FIXTURE ONLY)(TYP.) (ADD ALT 1)

REPLACE RUNWAY 16/34 EDGE LIGHTING CIRCUIT CABLE IN EXISTING 2" CONDUIT, SEE ELECTRICAL PLANS. (ADD ALT 1)

REPLACE RUNWAY 16/34 EDGE LIGHTING CIRCUIT CABLE IN EXISTING 2" CONDUIT, SEE ELECTRICAL PLANS. (ADD ALT 1)

REPLACE HIGH INTENSITY IN-PAVEMENT RUNWAY LIGHT, QUARTZ (FIXTURE ONLY)(TYP.) (BASE BID)

EXISTING RUNWAY DISTANCE REMAINING SIGN NOT TO BE DISTURBED

EXISTING RUNWAY DISTANCE REMAINING SIGN NOT TO BE DISTURBED

EXISTING 4-BOX PAPI NOT TO BE DISTURBED

EXISTING GLIDESLOPE SHELTER NOT TO BE DISTURBED

RUNWAY 16 PAPI POWER CONTROL UNIT

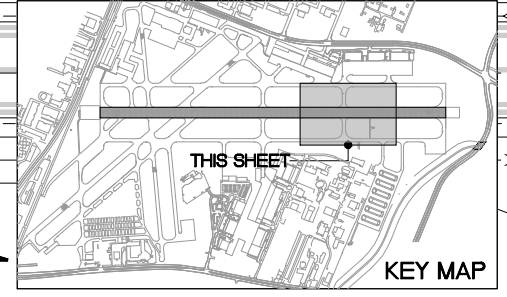
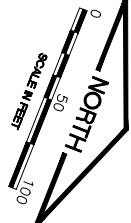

IL CONTRACT: PA059
 IL LETTING ITEM: 18A
 IL PROJECT: PWK-4414
 S.B.G. PROJECT: 3-17-SBGP-XX

SURVEY BOOK # 1302

REVISIONS		
NUMBER	BY	DATE

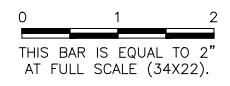

CHICAGO EXECUTIVE AIRPORT
WHEELING/PROSPECT HEIGHTS, ILLINOIS
REHABILITATE RUNWAY 16/34
EXISTING CONDITIONS AND
PROPOSED REMOVALS SHEET 4

© Copyright CMT, Inc.
CMT
 CRAWFORD, MURPHY & TILLY, INC.
 CONSULTING ENGINEERS
 License No. 184-000613



DESIGN BY:	SMS
DRAWN BY:	JRO
CHECKED BY:	SMS
APPROVED BY:	DKP
DATE:	06/19/2015
JOB No:	14290-05-00

FINAL

KREF DWG: bchrtl_ranway.dwg
PROJECT: 16-34 Base-NEW.dwg
CDL Alignments.dwg

IMAGE FILES: pwknewLOGO_CEA-4-Color-Small (2).jpg

UPDATE BY: Sean Smith
LAYOUT: EX COND 5

DATE: Thursday, July 9, 2015, 09:30:41
FILE: K:\Chicago\Exec\14290-05_RehabRW16-34\Draw\Sheets\17-21_EXST_COND.dwg

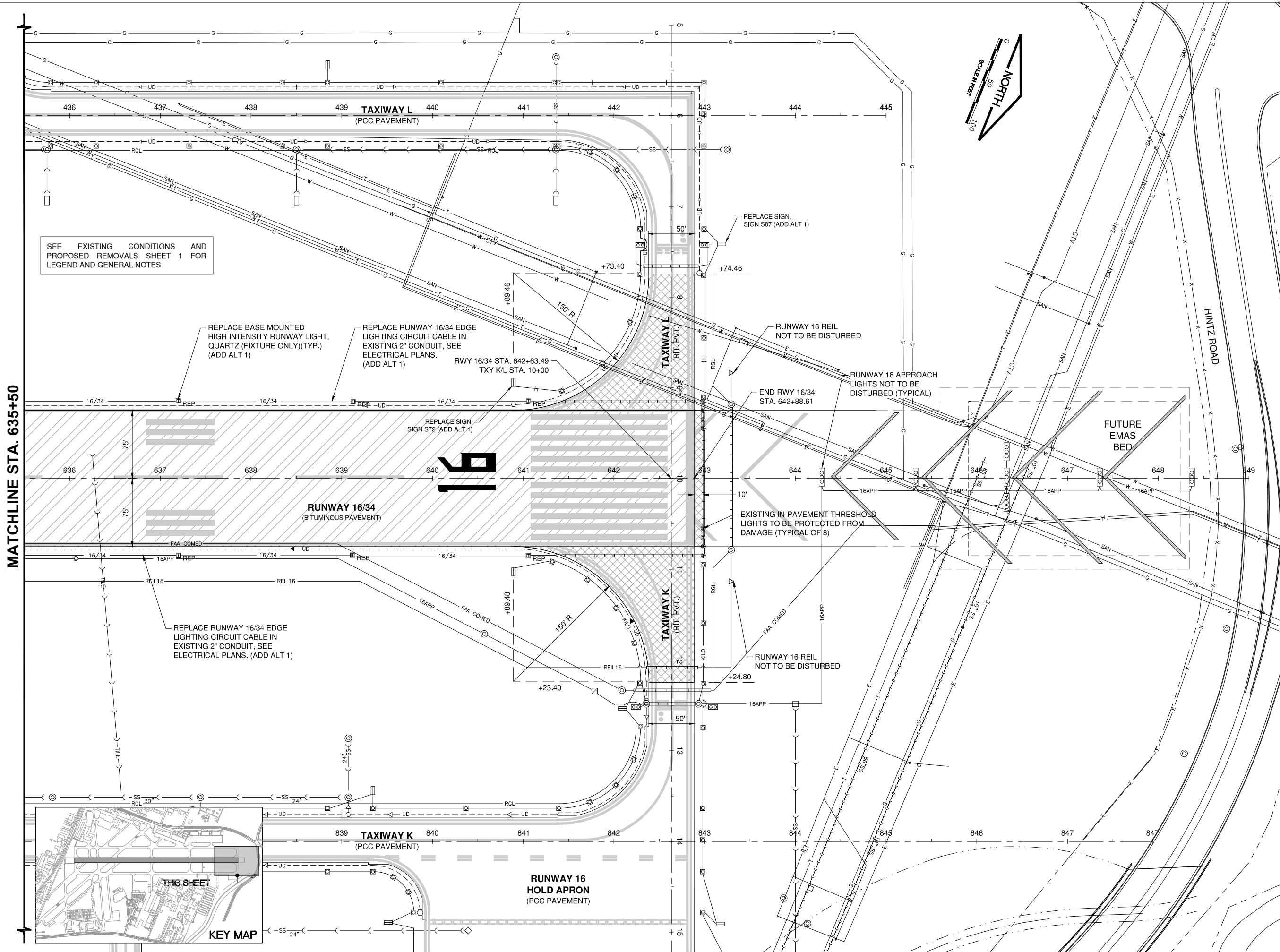

IL CONTRACT: PA059
IL LETTING ITEM: 18A
IL PROJECT: PWK-4414
S.B.G. PROJECT: 3-17-SBGP-XX

SURVEY BOOK # 1302

REVISIONS		
NUMBER	BY	DATE

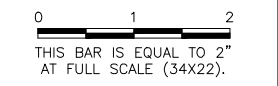

MATCHLINE STA. 635+50

**CHICAGO EXECUTIVE AIRPORT
WHEELING/PROSPECT HEIGHTS, ILLINOIS
REHABILITATE RUNWAY 16/34**

**EXISTING CONDITIONS AND
PROPOSED REMOVALS SHEET 5**

© Copyright CMT, Inc.

CMT
CRAWFORD, MURPHY & TILLY, INC.
CONSULTING ENGINEERS
License No. 184-000613

CHICAGO EXECUTIVE AIRPORT

DESIGN BY:	SMS
DRAWN BY:	JRO
CHECKED BY:	SMS
APPROVED BY:	DKP
DATE:	06/19/2015
JOB No:	14290-05-00

FINAL

REF: DWG: 142905 - C - PROROW.DWG
 (1/4" = 1' - 6" 3/4" base)
 (1/8" = 1' - 0" 1/2" base)
 (1/16" = 1' - 0" 1/4" base)

IMAGE FILES: pwrknewLOGO_CEA-4-Color-Small (2).jpg
 UPDATE BY: Sean Smith
 P&P: 1-24

DATE: Thursday, July 9, 2015, 09:31:27
 FILE: K:\Chicago\ref\14290-05_RehabRWY16-34_ProfileRWY_16-34.dwg

LEGEND

- NEW 4" BITUMINOUS OVERLAY
- NEW 2" BITUMINOUS OVERLAY
- NEW SHOULDER ADJUSTMENT AND LANDSCAPING
- EXISTING STORM SEWER
- EXISTING INLET/MANHOLE
- EXISTING SLOPE BOX
- EXISTING ELECTRICAL MANHOLE/HANDHOLE
- EXISTING ELECTRICAL DUCT
- EXISTING BASE MOUNTED RUNWAY LIGHT
- EXISTING BASE MOUNTED TAXIWAY LIGHT
- EXISTING IN-PAVEMENT RUNWAY LIGHT
- EXISTING TAXI GUIDANCE SIGN
- EXISTING UNDERDRAIN
- EXISTING UNDERDRAIN COLLECTION STRUCTURE
- EXISTING WATERMAIN
- EXISTING SANITARY SEWER
- EXISTING PERIMETER FENCE
- M MATCH EXISTING ELEVATION
- A ITEM TO BE ADJUSTED

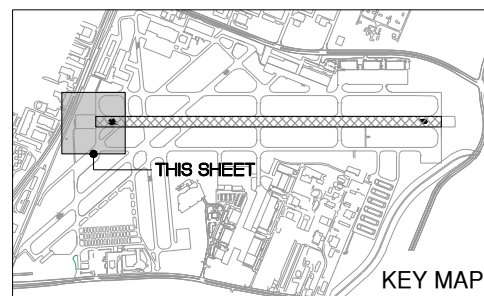

NOTES

- IT IS THE CONTRACTOR'S RESPONSIBILITY TO FIELD VERIFY THE LOCATION OF EXISTING UTILITIES. ANY DAMAGE TO EXISTING UTILITIES SHALL BE REPAIRED IMMEDIATELY AT THE CONTRACTOR'S EXPENSE.
- CONSTRUCT TRANSITION AT THE END OF EACH DAY'S PAVING IN ACCORDANCE WITH THE TEMPORARY BITUMINOUS TRANSITION RAMP DETAIL. NO ADDITIONAL PAYMENT SHALL BE MADE FOR TRANSITION RAMPS AS THE NUMBER AND SIZE OF THE TRANSITIONS ARE DEPENDENT ON CONTRACTOR SCHEDULING AND PRODUCTION RATES.
- CONTRACTOR SHALL EXERCISE EXTREME CARE WHEN MILLING NEAR IN-PAVEMENT LIGHT CANS TO AVOID DAMAGE TO LIGHT CANS TO REMAIN. DAMAGED LIGHT CANS SHALL BE REPLACED AT THE CONTRACTOR'S EXPENSE TO THE SATISFACTION OF THE ENGINEER.
- SEE PAVEMENT MARKINGS SHEETS 1 THROUGH 5 AND PAVEMENT MARKING DETAILS FOR TEMPORARY PAVEMENT MARKING REQUIREMENTS.
- SEE ELECTRICAL IMPROVEMENTS, SHEETS 1 THROUGH 5 FOR LIGHT ADJUSTMENTS, REPLACEMENT AND CABLE INSTALLATION.
- EXISTING IN-PAVEMENT DUCT MARKERS WITHIN THE LIMITS OF CONSTRUCTION SHALL BE SURVEYED PRIOR TO MILLING THE SURFACE AND REPLACED AT THE COMPLETION OF WORK, COSTS INCIDENTAL.

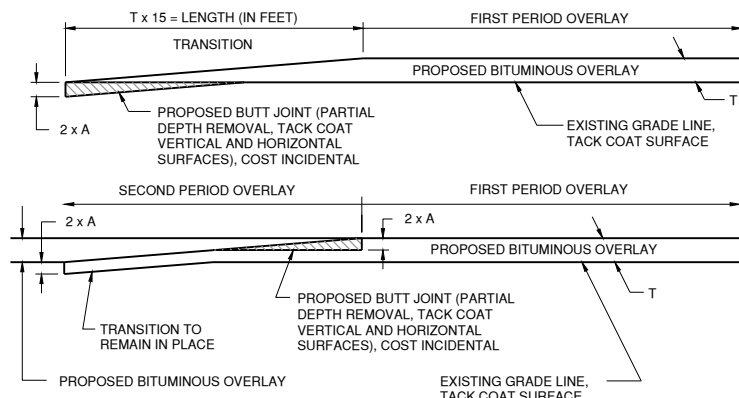

T = THICKNESS OF OVERLAY/LIFT (INCHES)
 A = SIZE OF MAXIMUM AGGREGATE (INCHES)

TEMPORARY BITUMINOUS TRANSITION RAMP

NO SCALE

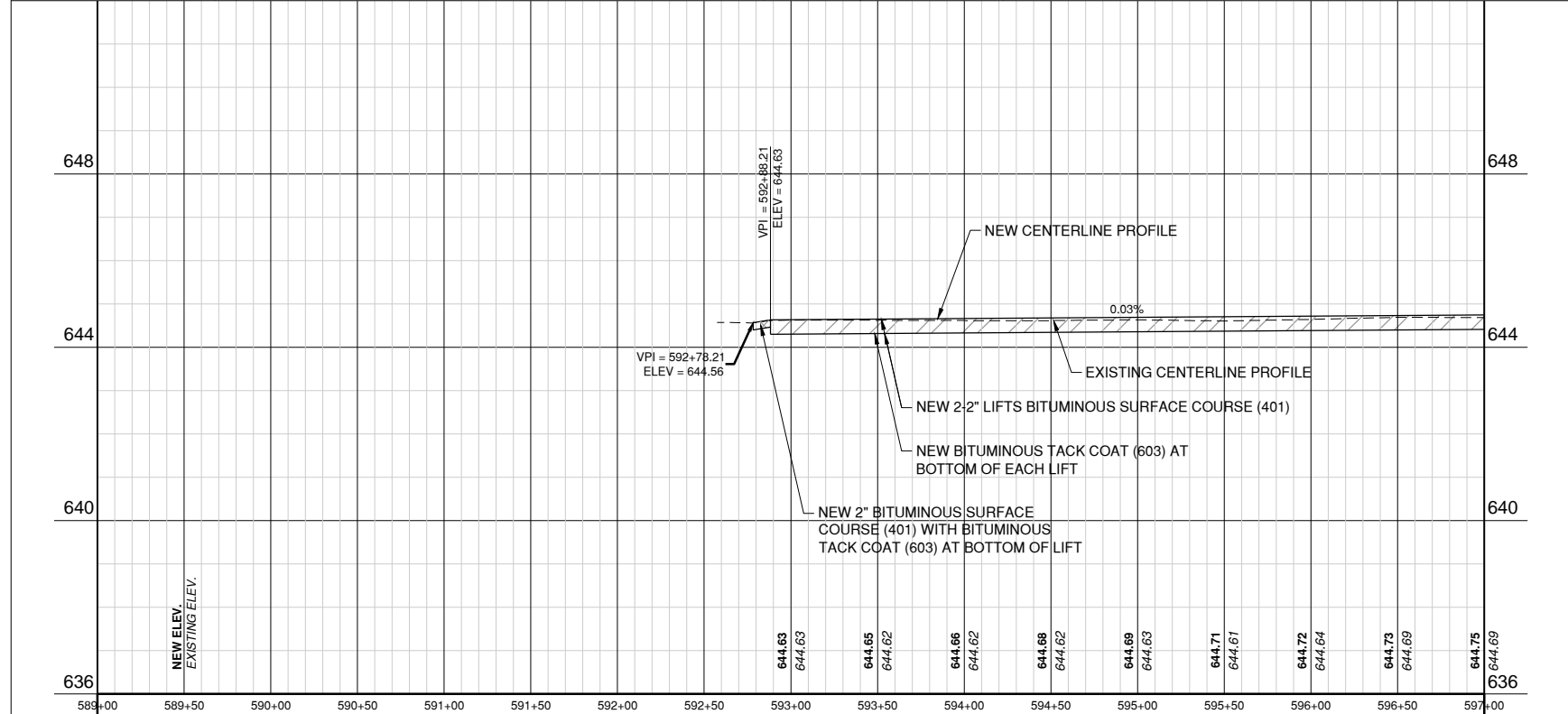
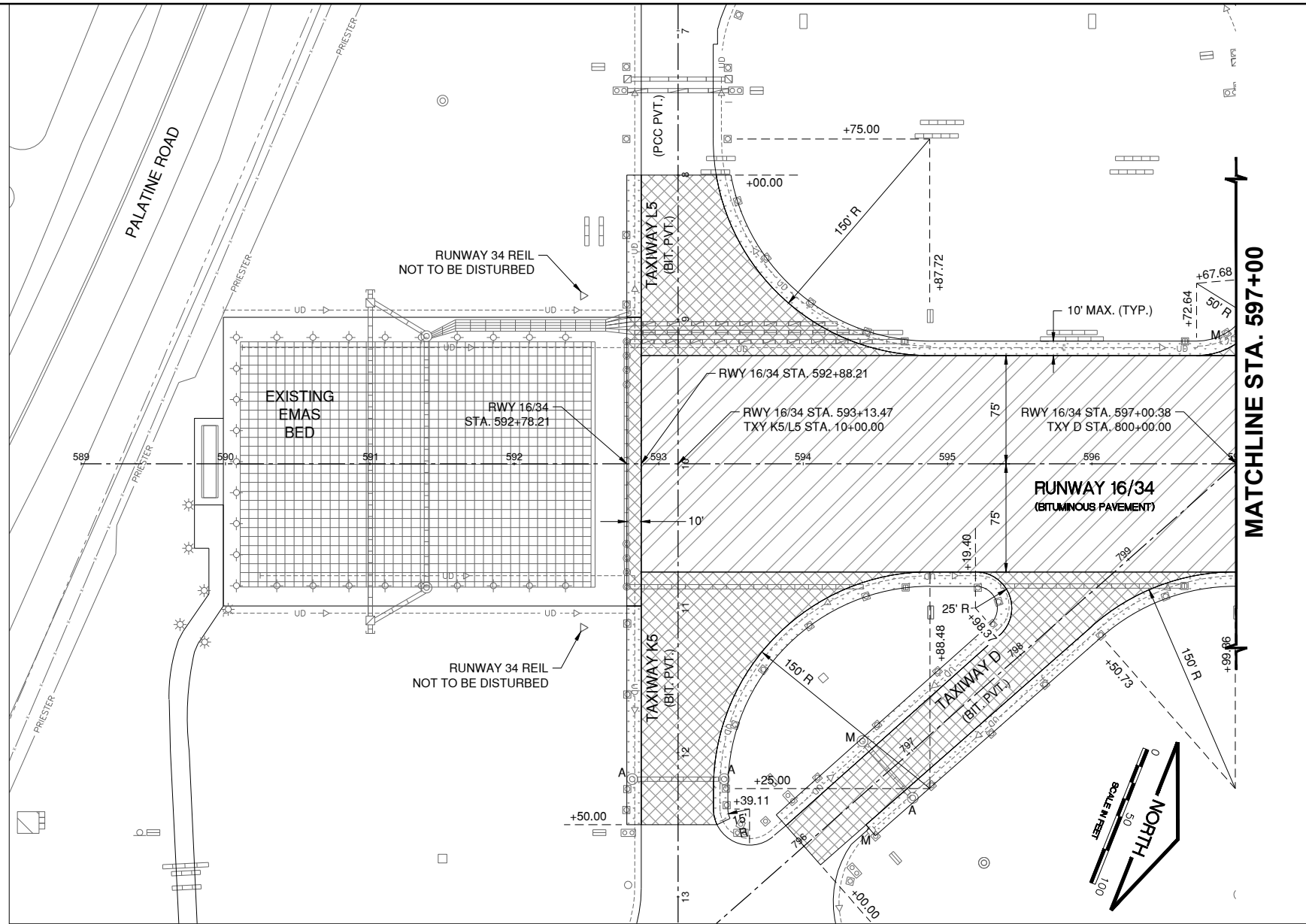

IL. CONTRACT: PA059
 IL. LETTING ITEM: 18A
 IL. PROJECT: PWK-4414
 S.B.G. PROJECT: 3-17-SBGP-XX

REVISIONS		
NUMBER	BY	DATE

0 1 2
 THIS BAR IS EQUAL TO 2" AT FULL SCALE (34X22).

CHICAGO EXECUTIVE AIRPORT
 WHEELING/PROSPECT HEIGHTS, ILLINOIS
 REHABILITATE RUNWAY 16/34

RUNWAY 16/34 PLAN AND PROFILE
 SHEET 1

© Copyright CMT, Inc.

CMT
 CRAWFORD, MURPHY & TILLY, INC.
 CONSULTING ENGINEERS
 License No. 184-000613

DESIGN BY:	SMS
DRAWN BY:	JRO
CHECKED BY:	SMS
APPROVED BY:	DKP
DATE:	06/19/2015
JOB No:	14290-05-00

FINAL

REF: DWG: 1429005 - C - PROPOSED
 FORM: 16-34 base.dwg
 FORM: 16-34 base.dwg
 FORM: 16-34 electrical base.dwg

IMAGE FILES: pwknewLOGO_CEA-4-COLOR-SMALL (2).jpg

UPDATE BY: Sean Smith
 LAYOUT: P&P 2

DATE: Thursday, July 9, 2015, 09:31:41
 FILE: K:\Chicago\Tech\14290-05_RehabRW16-34\Draw\Sheets\2-26_PROFILE RWY 16-34.dwg

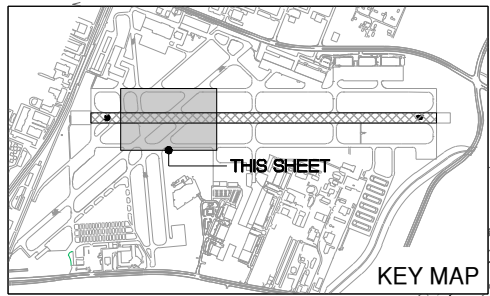
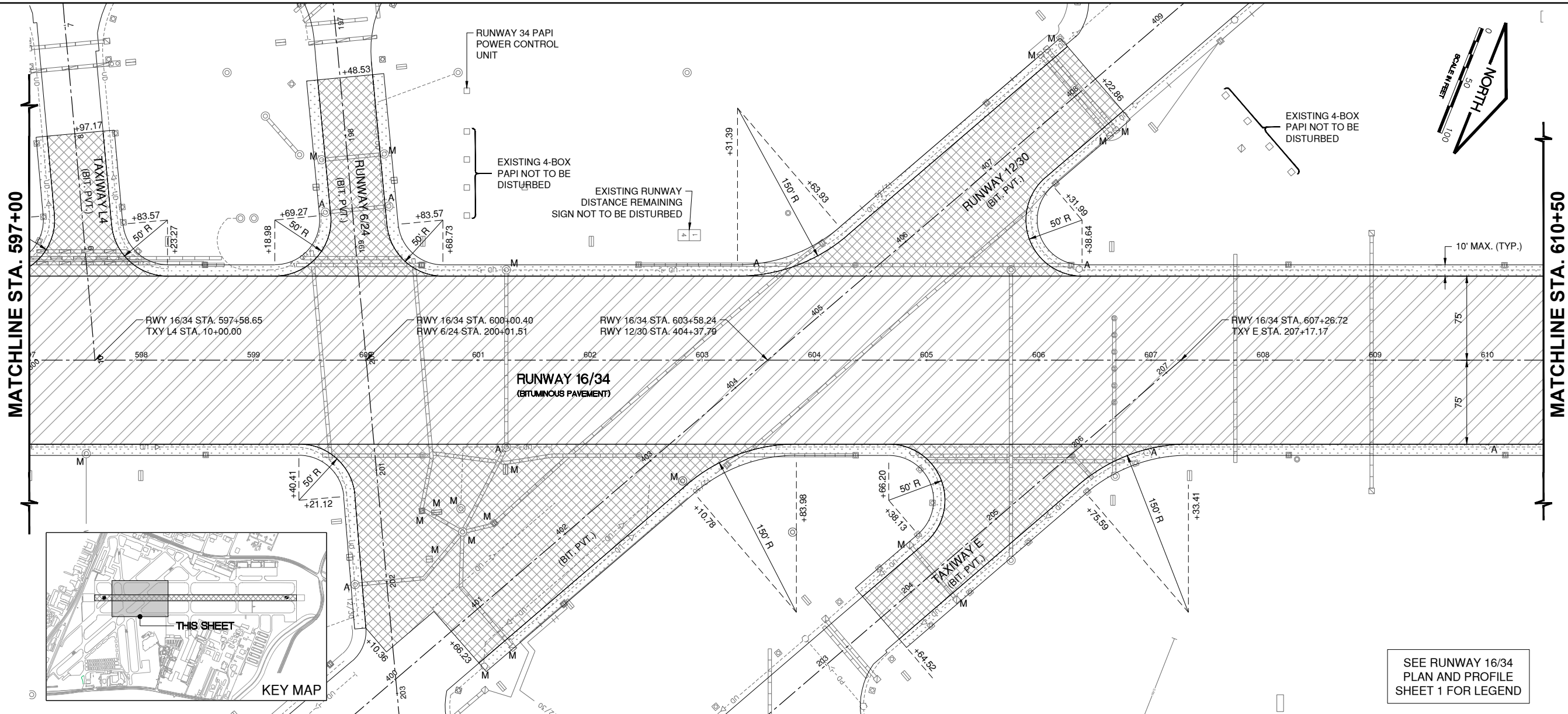

SEE RUNWAY 16/34
 PLAN AND PROFILE
 SHEET 1 FOR LEGEND

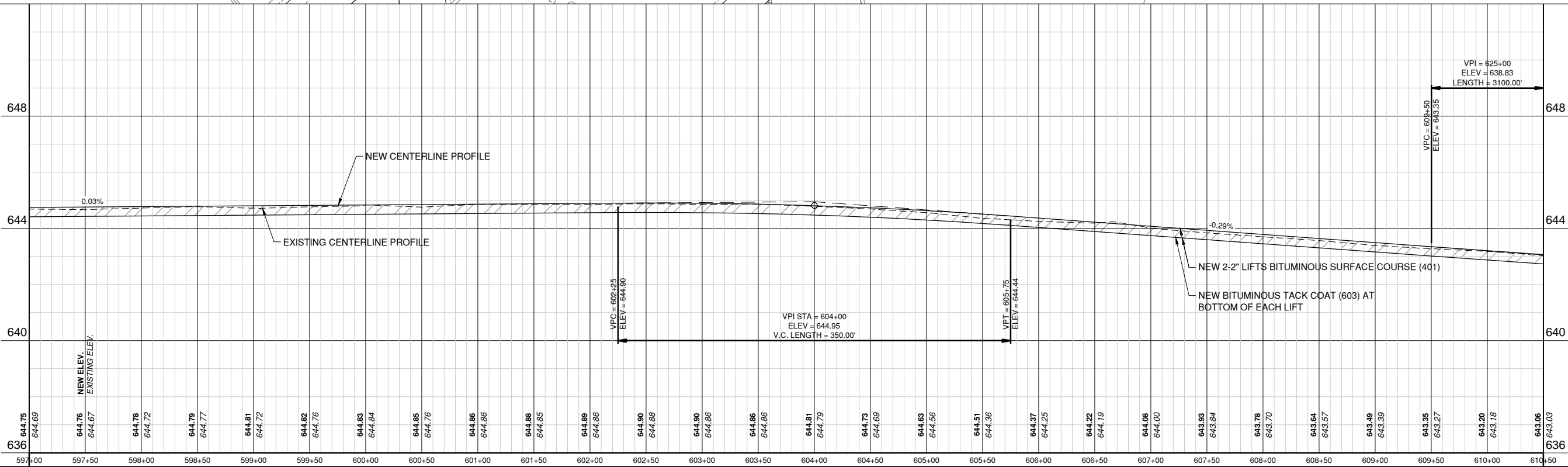

IL CONTRACT: PA059
 IL LETTING ITEM: 18A
 IL PROJECT: PWK-4414
 S.B.G. PROJECT: 3-17-SBGP-XX

SURVEY BOOK # 1302

REVISIONS		
NUMBER	BY	DATE

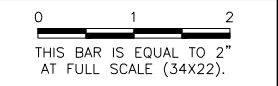

CHICAGO EXECUTIVE AIRPORT
 WHEELING/PROSPECT HEIGHTS, ILLINOIS
 REHABILITATE RUNWAY 16/34
 RUNWAY 16/34 PLAN AND PROFILE
 SHEET 2

© Copyright CMT, Inc.

CMT
 CRAWFORD, MURPHY & TILLY, INC.
 CONSULTING ENGINEERS
 License No. 184-000613

CHICAGO EXECUTIVE AIRPORT

DESIGN BY:	SMS
DRAWN BY:	JRO
CHECKED BY:	SMS
APPROVED BY:	DKP
DATE:	06/19/2015
JOB No:	14290-05-00

FINAL

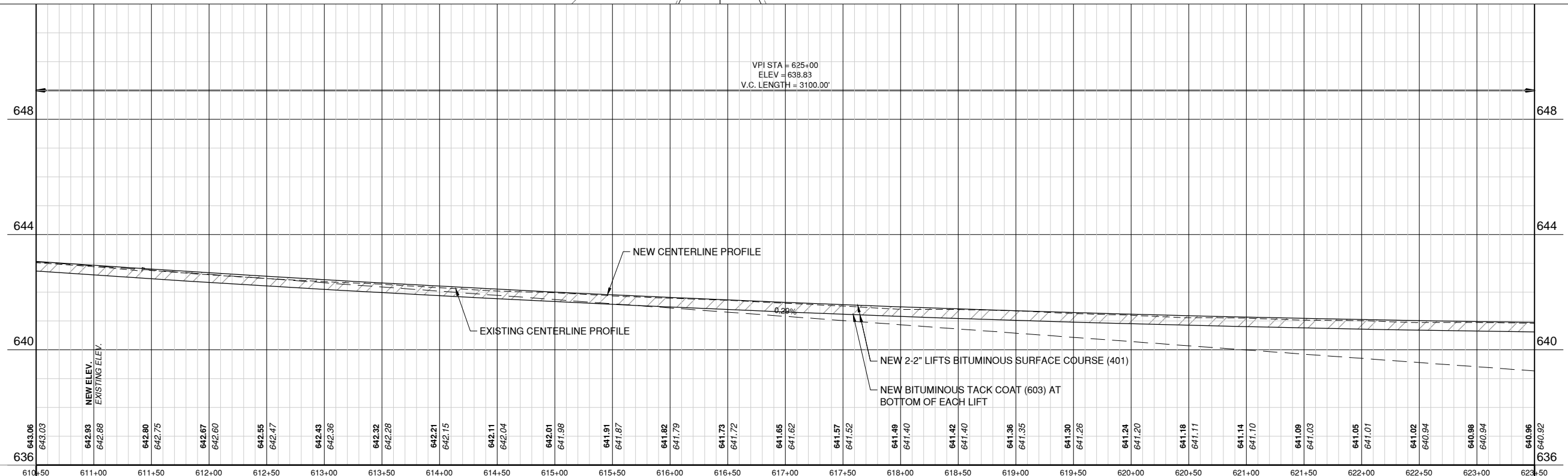
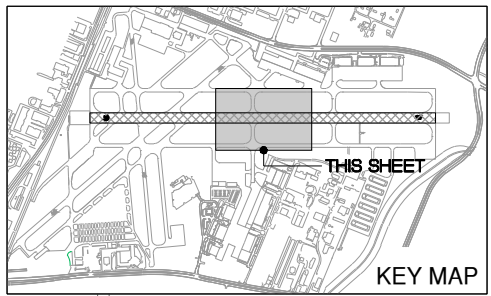
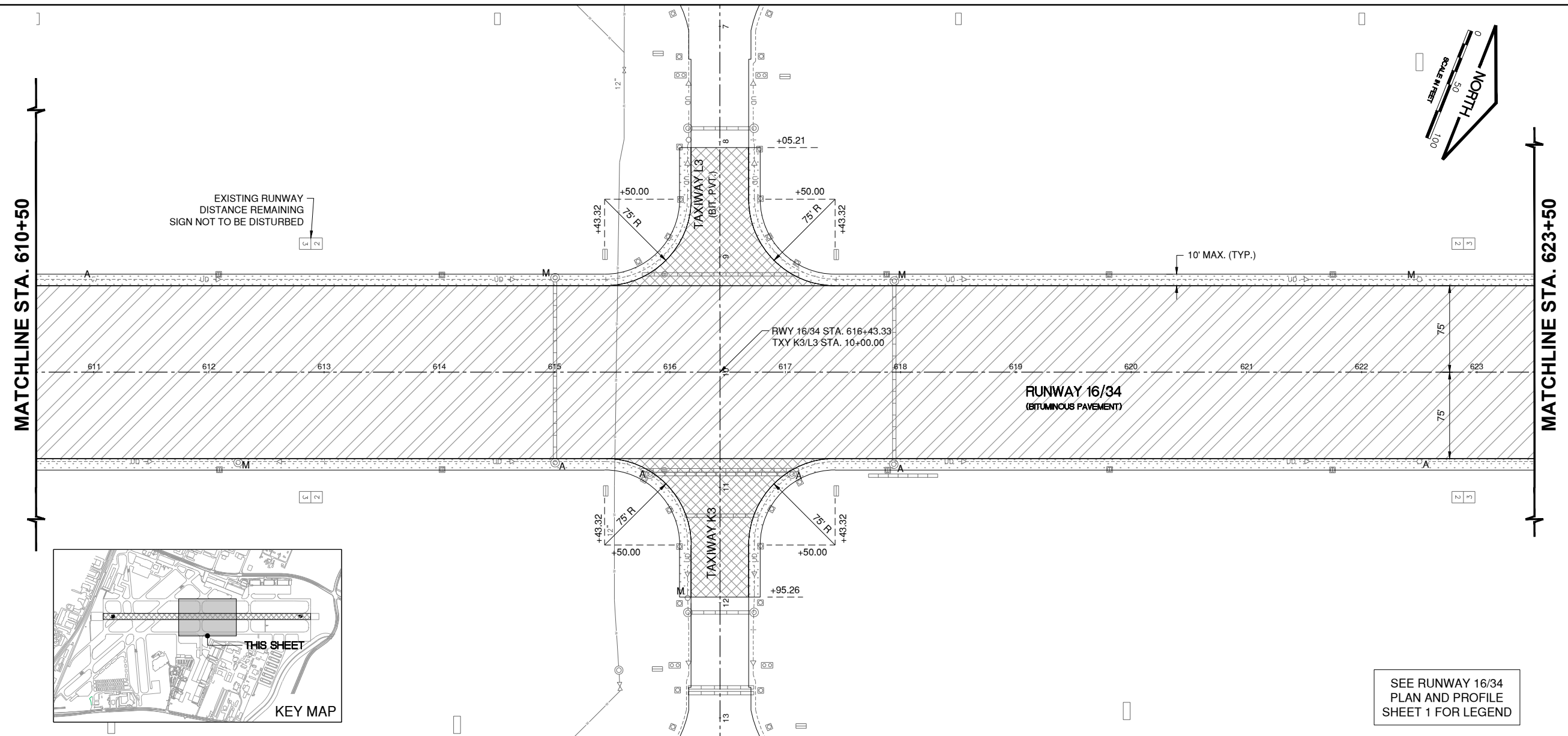

REVISIONS

NUMBER	BY	DATE

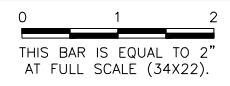

CHICAGO EXECUTIVE AIRPORT
WHEELING/PROSPECT HEIGHTS, ILLINOIS
REHABILITATE RUNWAY 16/34

RUNWAY 16/34 PLAN AND PROFILE
SHEET 3

© Copyright CMT, Inc.

CMT
CRAWFORD, MURPHY & TILLY, INC.
CONSULTING ENGINEERS
License No. 184-000613

DESIGN BY:	SMS
DRAWN BY:	JRO
CHECKED BY:	SMS
APPROVED BY:	DKP
DATE:	06/19/2015
JOB No:	14290-05-00

FINAL

KREF DWG: 1429005 - C - PROR-DWG
 FORM: 16-34 base.dwg
 FORM: 16-34 electrical base.dwg

IMAGE FILES: pwknewLOGO_CEA-4-Color-Small (2).pdf

UPDATE BY: Sean Smith
 LAYOUT: P&P 4

DATE: Thursday, July 9, 2015, 09:32:11
 FILE: K:\Chicago\14290-05-RehabRWY16-34\Draw\Sheets\22-26 PROFILE RWY 16-34.dwg

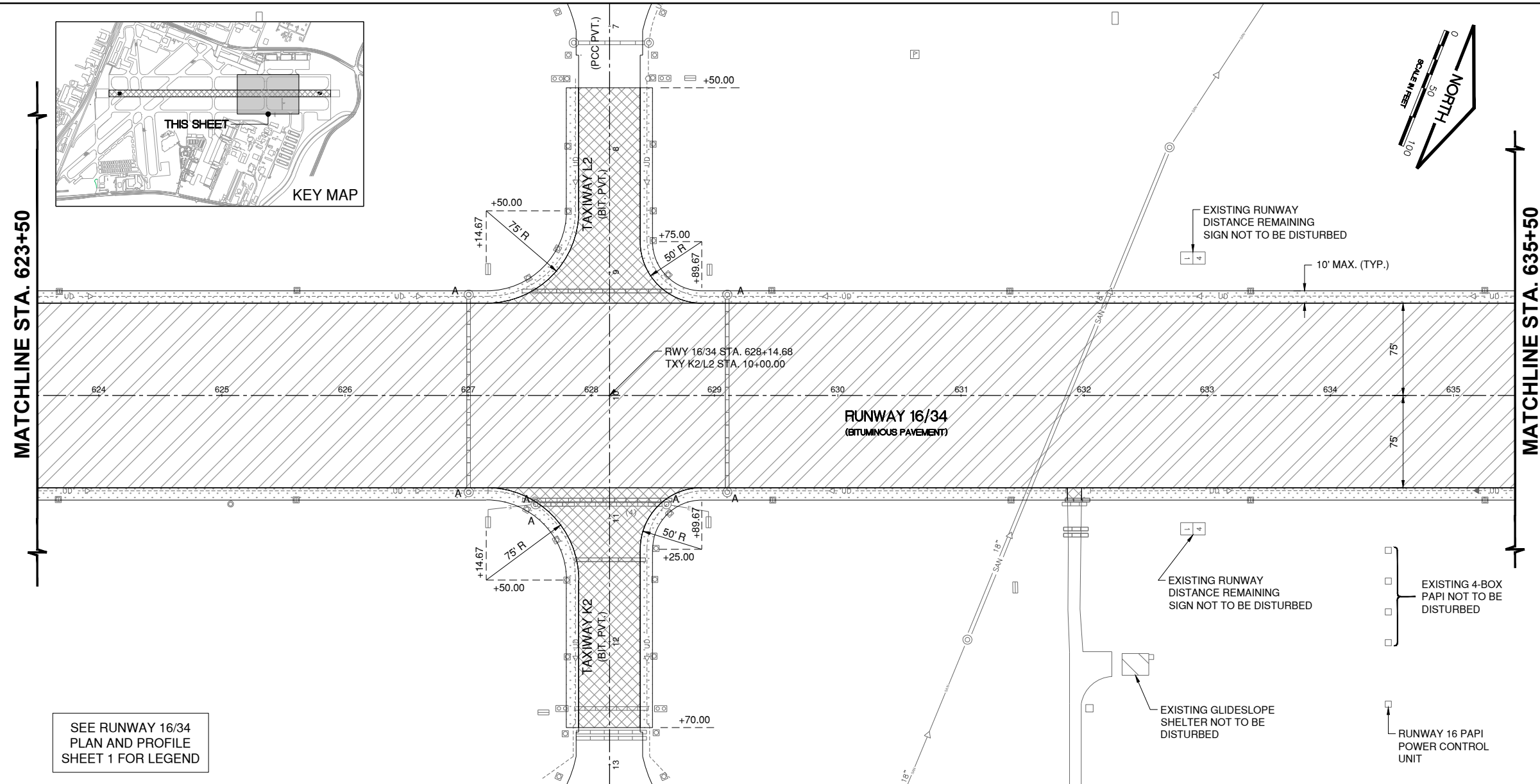

SEE RUNWAY 16/34
 PLAN AND PROFILE
 SHEET 1 FOR LEGEND

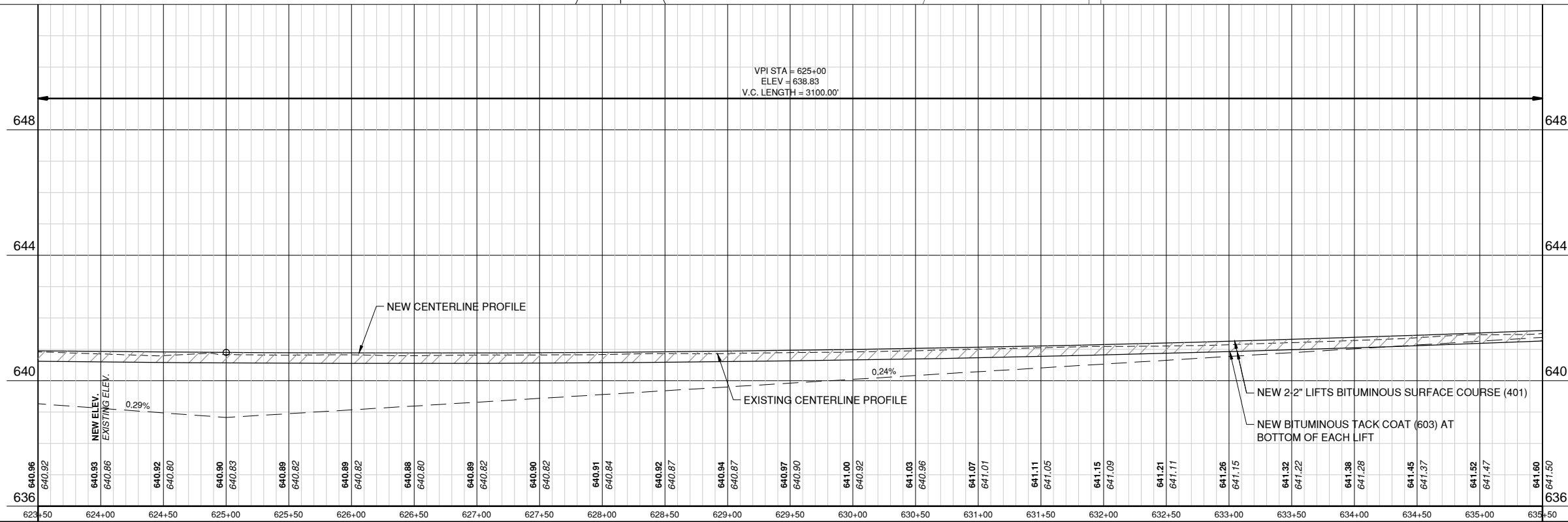

IL. CONTRACT: PA059
 IL. LETTING ITEM: 18A
 IL. PROJECT: PWK-4414
 S.B.G. PROJECT: 3-17-SBGP-XX

SURVEY BOOK # 1302

REVISIONS		
NUMBER	BY	DATE

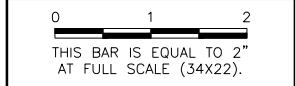

CHICAGO EXECUTIVE AIRPORT
 WHEELING/PROSPECT HEIGHTS, ILLINOIS
 REHABILITATE RUNWAY 16/34

RUNWAY 16/34 PLAN AND PROFILE
 SHEET 4

© Copyright CMT, Inc.

CMT
 CRAWFORD, MURPHY & TILLY, INC.
 CONSULTING ENGINEERS
 License No. 184-000613

CHICAGO EXECUTIVE AIRPORT

DESIGN BY: SMS
 DRAWN BY: JRO
 CHECKED BY: SMS
 APPROVED BY: DKP
 DATE: 06/19/2015
 JOB No: 14290-05-00

FINAL

SHEET 25 OF 58 SHEETS

KREF DWG: 1429005 - C - PRROR.DWG
 FORMNO: 16-34 base.dwg
 FORMNO: 16-34 electrical base.dwg

IMAGE FILES: pwknewLOGG_CEA-4-COLOR-Small (2).pdf

UPDATE BY: Sean Smith
 LAYOUT: P&P 5

DATE: Thursday, July 9, 2015, 09:32:27
 FILE: K:\Chicago\Tech\14290-05_RehabRWY16-34\Draw\Sheets\22-26_PROFILE.RWY_16-34.dwg

MATCHLINE STA. 635+50

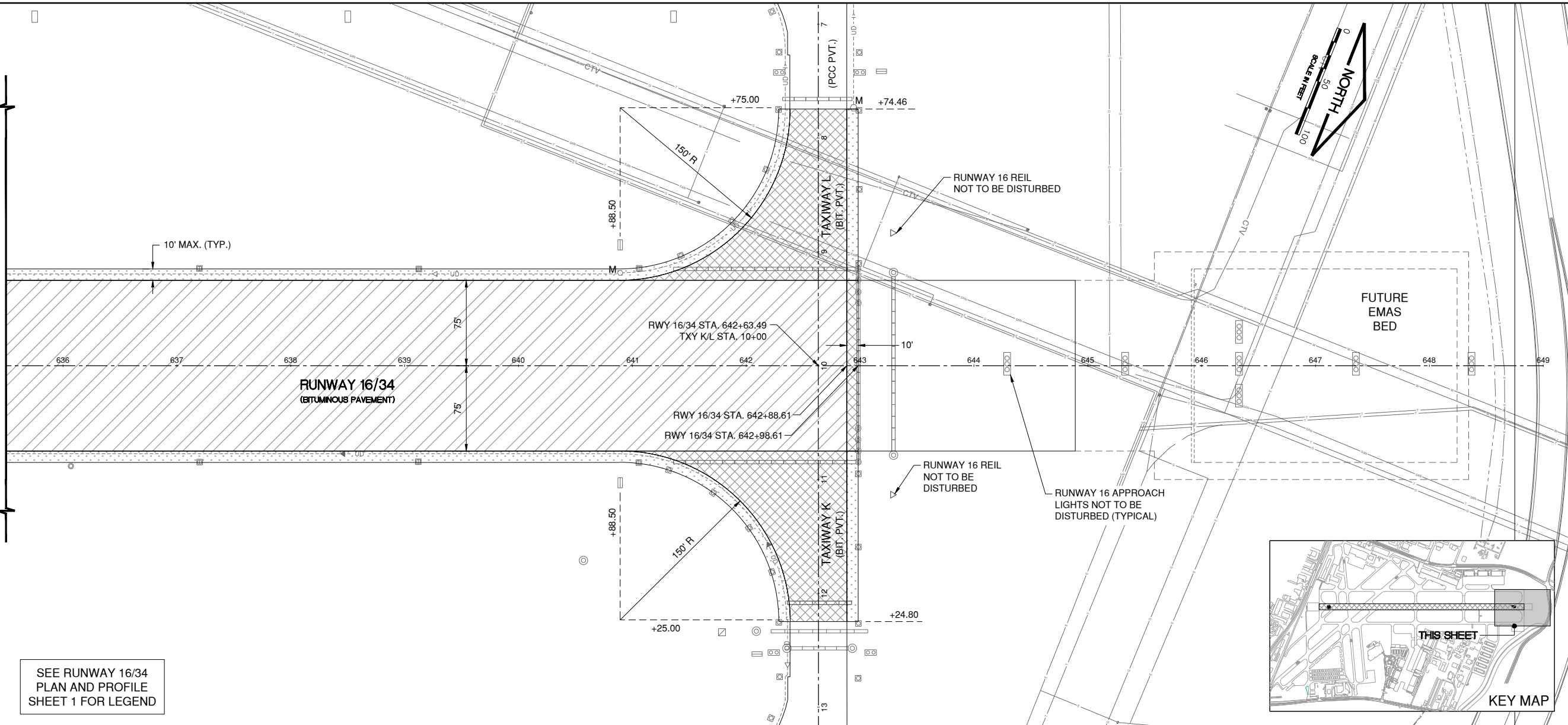

SEE RUNWAY 16/34
 PLAN AND PROFILE
 SHEET 1 FOR LEGEND

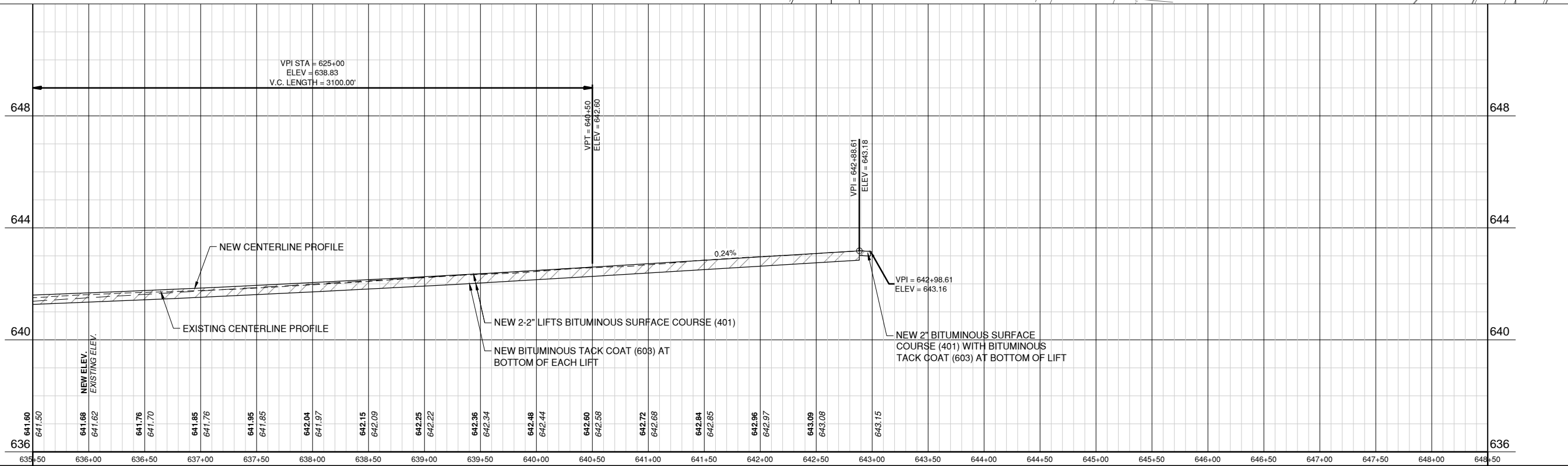
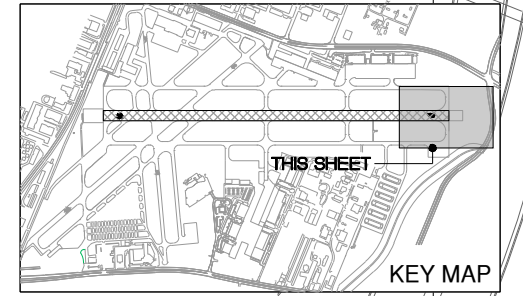

IL. CONTRACT: PA059
 IL. LETTING ITEM: 18A
 IL. PROJECT: PWK-4414
 S.B.G. PROJECT: 3-17-SBGP-XX

SURVEY BOOK # 1302

REVISIONS		
NUMBER	BY	DATE

0 1 2
 THIS BAR IS EQUAL TO 2" AT FULL SCALE (34X22).

CHICAGO EXECUTIVE AIRPORT
 WHEELING/PROSPECT HEIGHTS, ILLINOIS
 REHABILITATE RUNWAY 16/34

RUNWAY 16/34 PLAN AND PROFILE
 SHEET 5

© Copyright CMT, Inc.

CMT
 CRAWFORD, MURPHY & TILLY, INC.
 CONSULTING ENGINEERS
 License No. 184-000613

CHICAGO EXECUTIVE AIRPORT

DESIGN BY:	SMS
DRAWN BY:	JRO
CHECKED BY:	SMS
APPROVED BY:	DKP
DATE:	06/19/2015
JOB No:	14290-05-00
FINAL	
SHEET 26 OF 58 SHEETS	

REF DWG: 142905 - C - PRORF.dwg
 C:\Users\mroy_1\csd\wgs
 C:\Users\mroy_1\csd\wgs
 6/10/15 10:54:58 AM - NEW.dwg

UPDATE BY: Sean Smith
 LAYOUT: P&P_TXY_K-L

IMAGE FILES: pwknewLOGO_CEA-4-Color-Small (2).jpg

DATE: Thursday, July 9, 2015, 09:33:30
 FILE: K:\Chicago\ref\142905-05-Relat\RWY16-34\Draw\Sheets\27_P&P_TXY_K.dwg

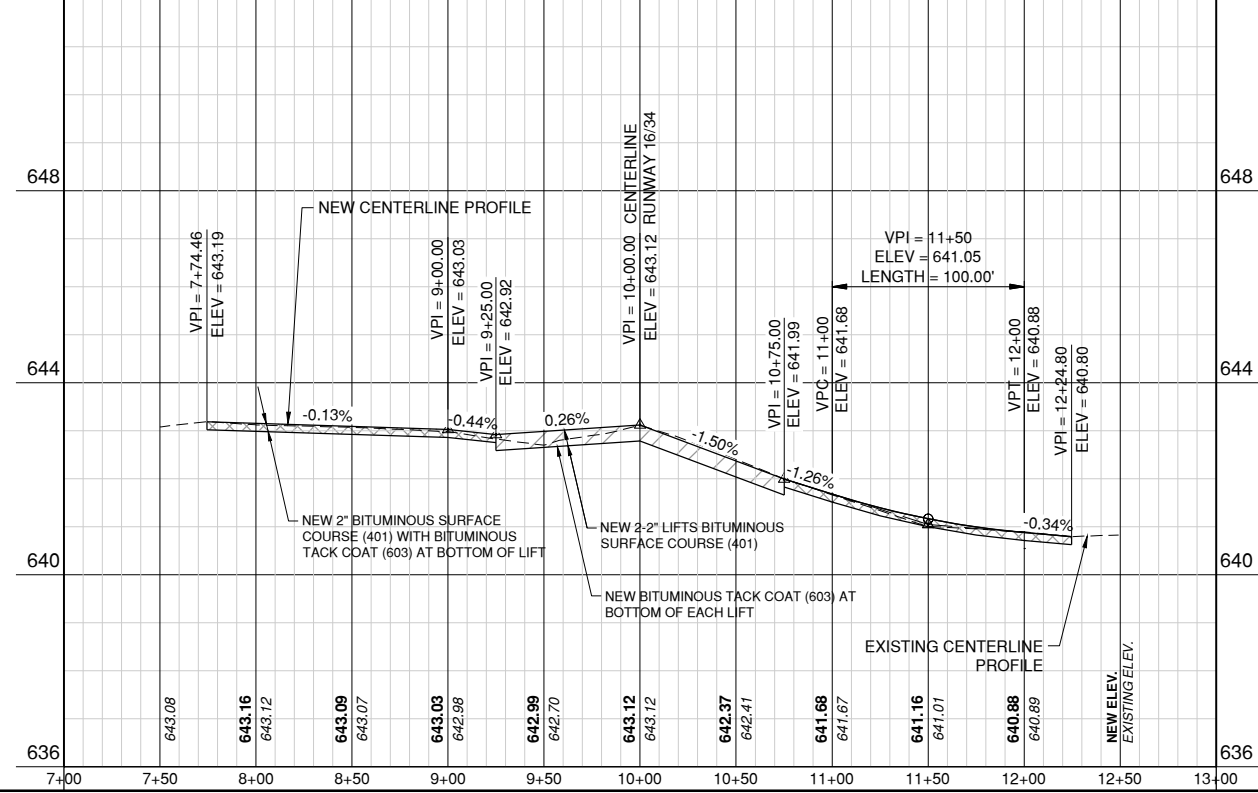
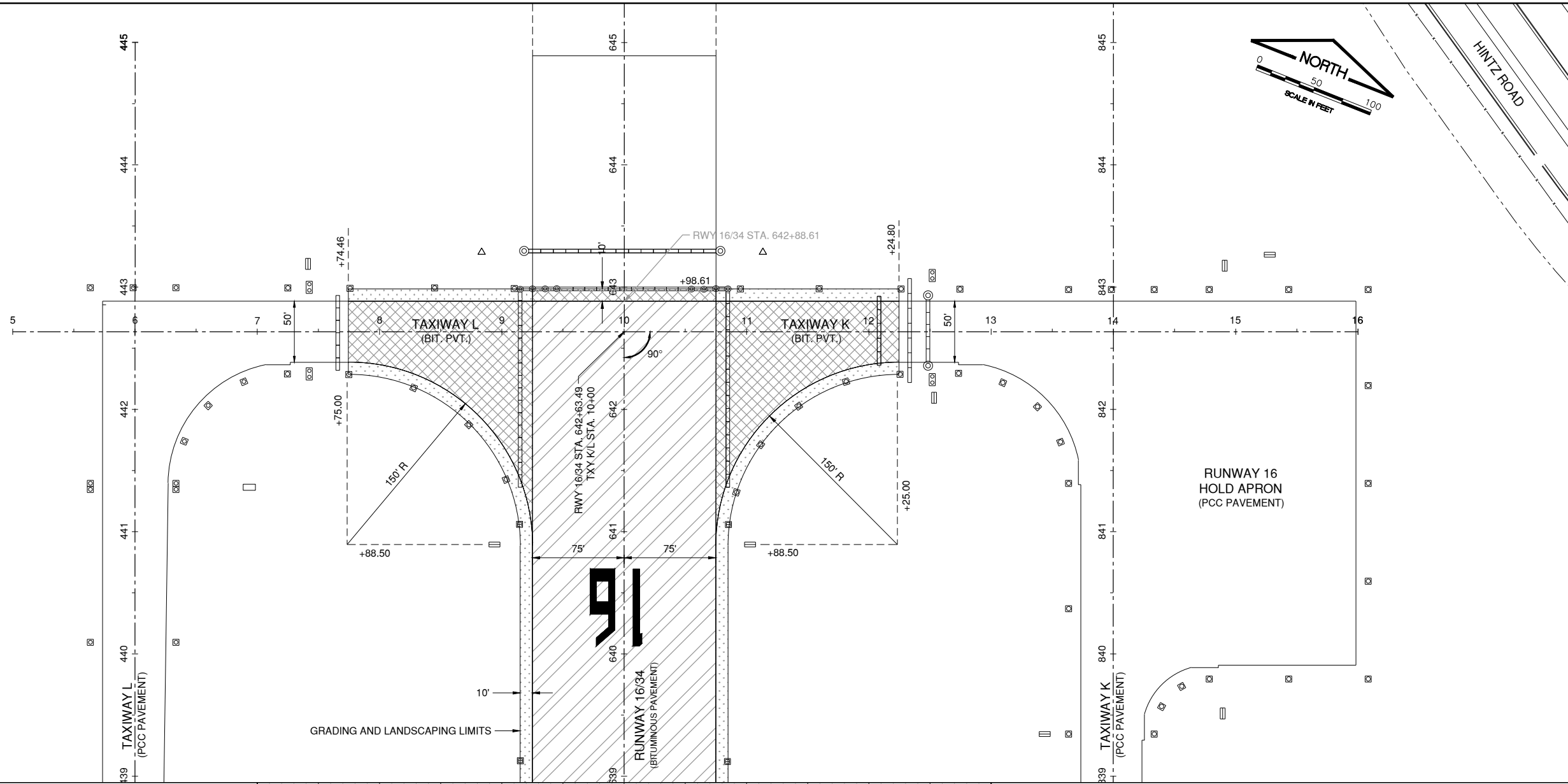
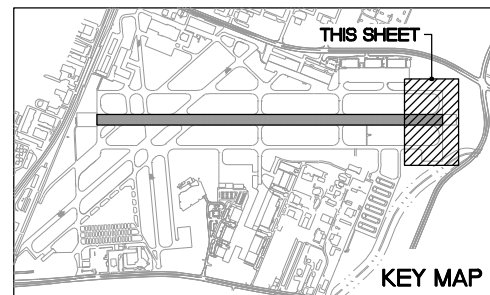

SEE RUNWAY 16/34
 PLAN AND PROFILE
 SHEET 1 FOR LEGEND

SEE RUNWAY 16/34
 PLAN AND PROFILE
 SHEETS FOR
 STRUCTURE ADJUSTMENTS

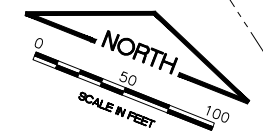

IL. CONTRACT: PA059
 IL. LETTING ITEM: 18A
 IL. PROJECT: PWK-4414
 S.B.G. PROJECT: 3-17-SBGP-XX

SURVEY BOOK # 1302

REVISIONS		
NUMBER	BY	DATE

0 1 2
 THIS BAR IS EQUAL TO 2"
 AT FULL SCALE (34X22).

CHICAGO EXECUTIVE AIRPORT
 WHEELING/PROSPECT HEIGHTS, ILLINOIS
 REHABILITATE RUNWAY 16/34

TAXIWAY K AND L PLAN AND PROFILE

© Copyright CMT, Inc.

CMT
 CRAWFORD, MURPHY & TILLY, INC.
 CONSULTING ENGINEERS
 License No. 184-000613

CHICAGO EXECUTIVE AIRPORT

DESIGN BY:	SMS
DRAWN BY:	JRO
CHECKED BY:	SMS
APPROVED BY:	DKP
DATE:	06/19/2015
JOB No:	14290-05-00
FINAL	
SHEET 27 OF 58 SHEETS	

REF: DWG: 1429005 - C - PRROR.dwg
 C:\A\Chicago\14290-05-RehabRW16-34\Draw\Sheets\28_P&P_TTY_K2.dwg
 UPDATE BY: Sean Smith
 LAYOUT: P&P_TTY_K2

IMAGE FILES: pwknewLOGO_CEA-4-Color-Small (2).jpg

UPDATE BY: Sean Smith
 LAYOUT: P&P_TTY_K2

DATE: Thursday, July 9, 2015, 09:34:34
 FILE: K:\Chicago\14290-05-RehabRW16-34\Draw\Sheets\28_P&P_TTY_K2.dwg

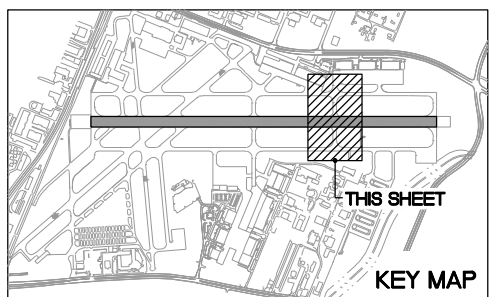
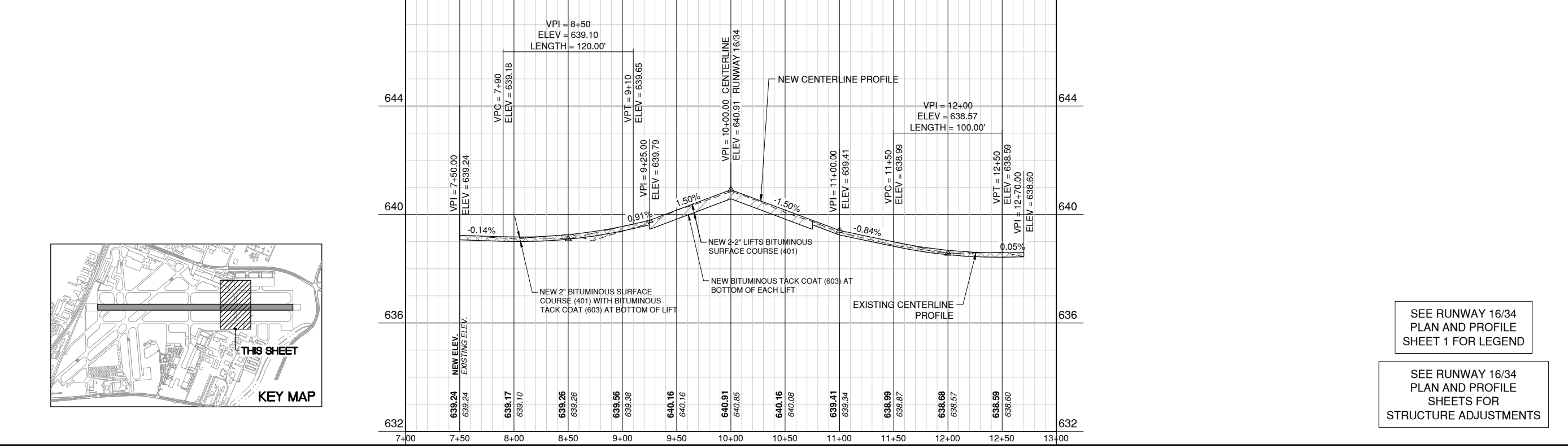
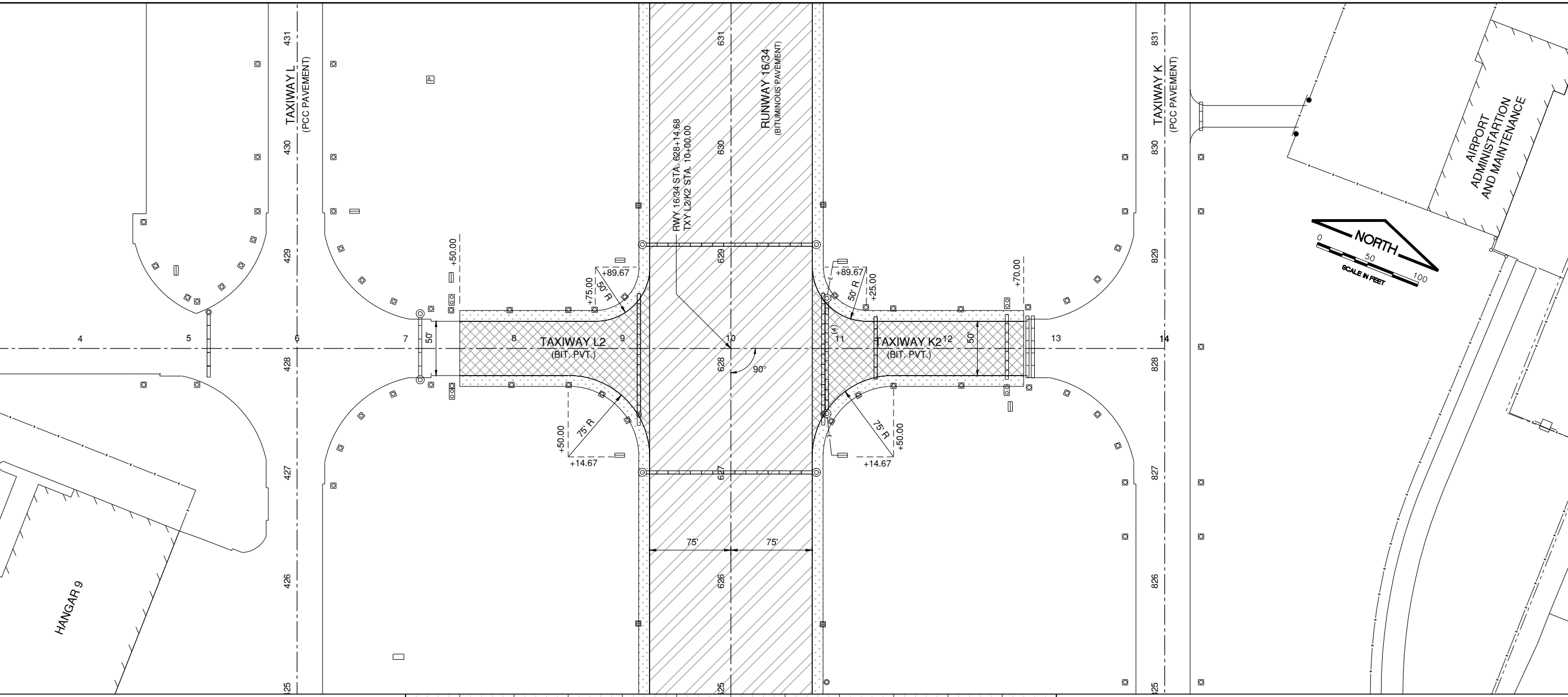

SEE RUNWAY 16/34
 PLAN AND PROFILE
 SHEET 1 FOR LEGEND

SEE RUNWAY 16/34
 PLAN AND PROFILE
 SHEETS FOR
 STRUCTURE ADJUSTMENTS

IL. CONTRACT: PA059
 IL. LETTING ITEM: 18A
 IL. PROJECT: PWK-4414
 S.B.G. PROJECT: 3-17-SBGP-XX

SURVEY BOOK # 1302

REVISIONS		
NUMBER	BY	DATE

0 1 2
 THIS BAR IS EQUAL TO 2"
 AT FULL SCALE (34X22).

CHICAGO EXECUTIVE AIRPORT
 WHEELING/PROSPECT HEIGHTS, ILLINOIS
 REHABILITATE RUNWAY 16/34

TAXIWAY K2 AND L2 PLAN AND PROFILE

© Copyright CMT, Inc.

CMT
 CRAWFORD, MURPHY & TILLY, INC.
 CONSULTING ENGINEERS
 License No. 184-000613

CHICAGO EXECUTIVE AIRPORT

DESIGN BY:	SMS
DRAWN BY:	JRO
CHECKED BY:	SMS
APPROVED BY:	DKP
DATE:	06/19/2015
JOB No:	14290-05-00
FINAL	
SHEET 28 OF 58 SHEETS	

KREF DWG: 142905 - C - PRORF.dwg
 I:\A\Airport\142905.dwg
 Runway 16-34 base-NEW.dwg

IMAGE FILES: pwkrunwaylogo_cga-4-color-smol(2).jpg

UPDATE BY: Sean Smith
 LAYOUT: P&P TXY K3

DATE: Thursday, July 9, 2015, 13:02:28
 FILE: K:\Chicago\cdp\142905-05_RenovRW16-34\Drawn_Sheets\29_P&P_TXY_K3.dwg

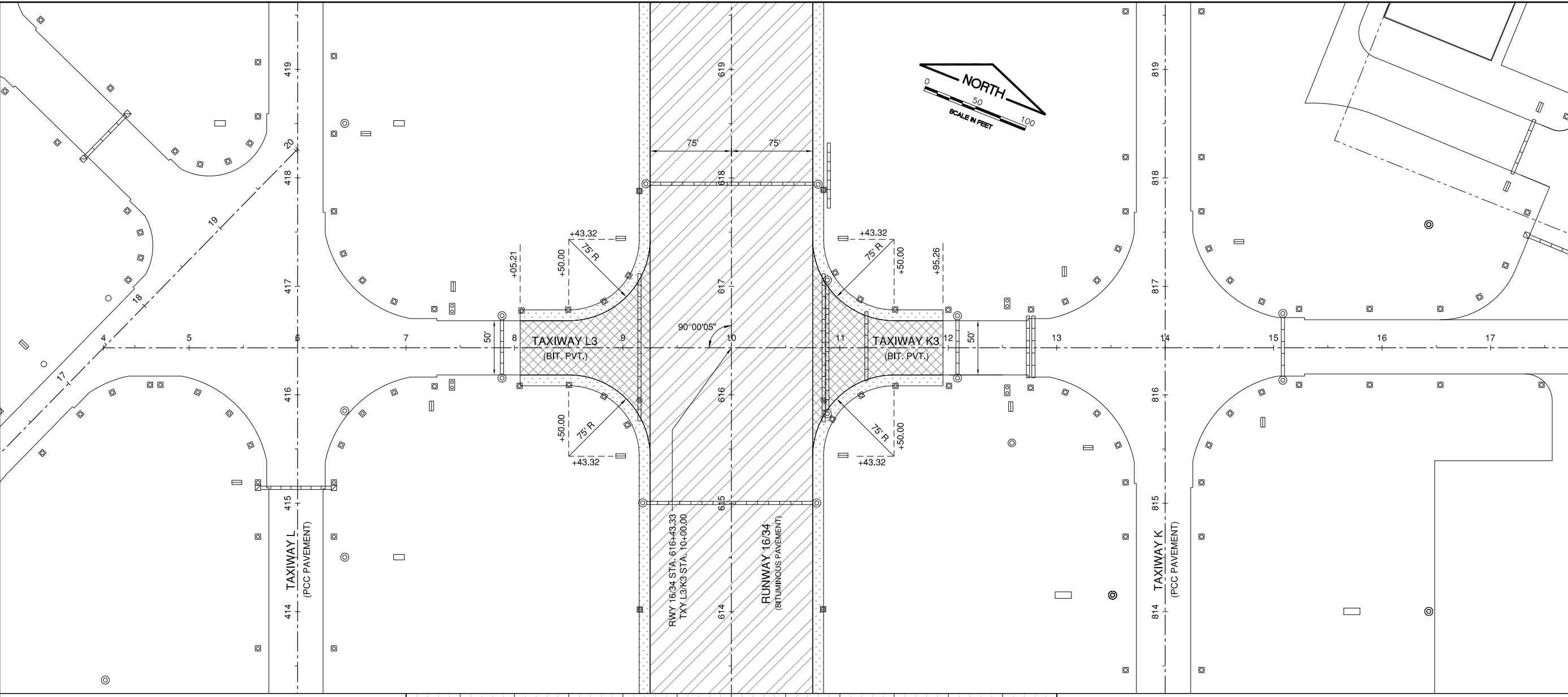

IL. CONTRACT: PA059
 IL. LETTING ITEM: 18A
 IL. PROJECT: PWK-4414
 S.B.G. PROJECT: 3-17-SBGP-XX

SURVEY BOOK # 1302

REVISIONS		
NUMBER	BY	DATE

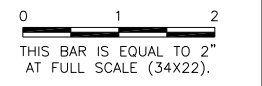

CHICAGO EXECUTIVE AIRPORT
 WHEELING/PROSPECT HEIGHTS, ILLINOIS
 REHABILITATE RUNWAY 16/34
 TAXIWAY K3 AND L3 PLAN AND PROFILE

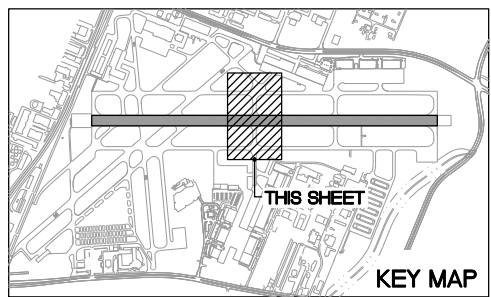
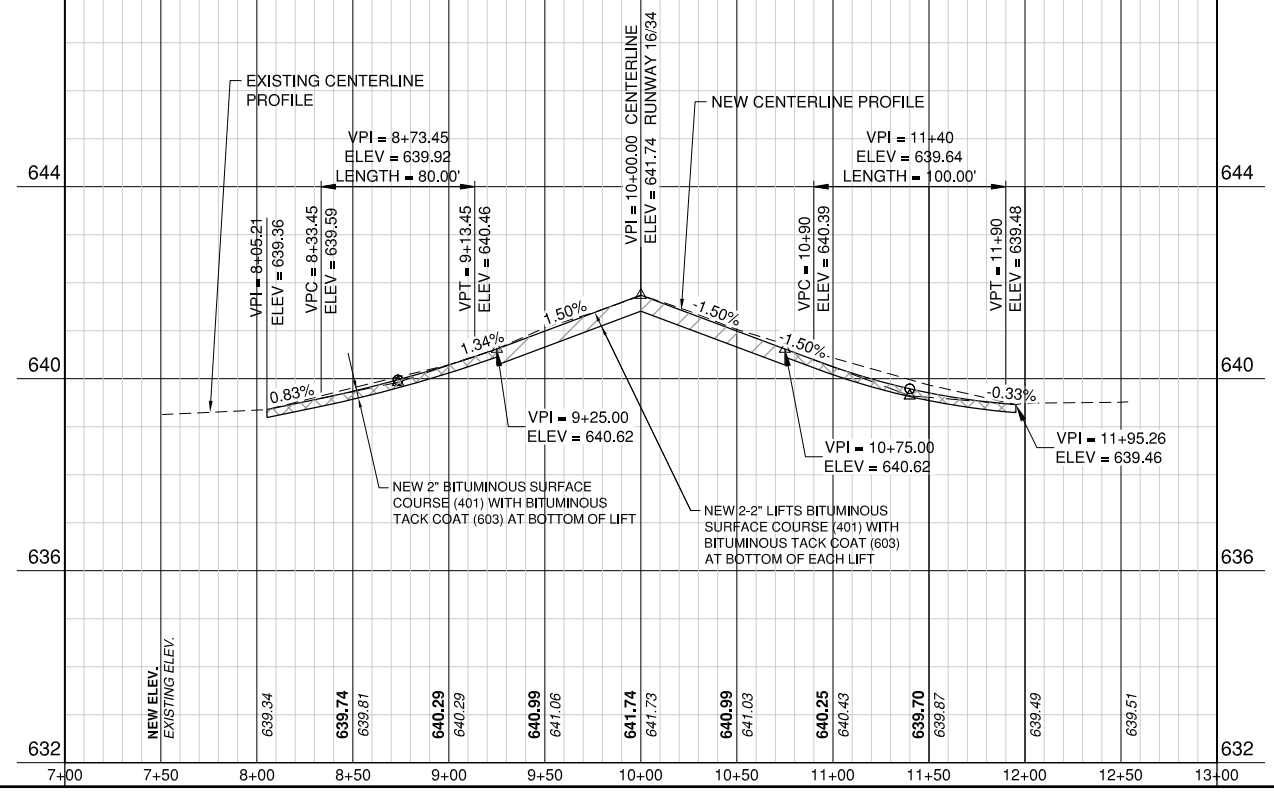

SEE RUNWAY 16/34
 PLAN AND PROFILE
 SHEET 1 FOR LEGEND

SEE RUNWAY 16/34
 PLAN AND PROFILE
 SHEETS FOR
 STRUCTURE ADJUSTMENTS

© Copyright CMT, Inc.
CMT
 CRAWFORD, MURPHY & TILLY, INC.
 CONSULTING ENGINEERS
 License No. 184-000613
CHICAGO EXECUTIVE AIRPORT

DESIGN BY:	SMS
DRAWN BY:	JRO
CHECKED BY:	SMS
APPROVED BY:	DKP
DATE:	06/19/2015
JOB No:	14290-05-00

FINAL

REF DWG: 142905 - C - PRORF.dwg
 C:\A\Drawings\142905.dwg
 C:\A\Drawings\142905.dwg
 Format: 16-34 05se-NEW.dwg

IMAGE FILES: pwknewLOGO_CCA-4-Color-Small (2).jpg

UPDATE BY: Sean Smith
 LAYOUT: P&P_TXY_E

DATE: Thursday, July 9, 2015, 09:36:39
 FILE: K:\Chicago\142905-05_RehabRWY16-34\Drawn\Sheets\30_P&P_TXY_E.dwg

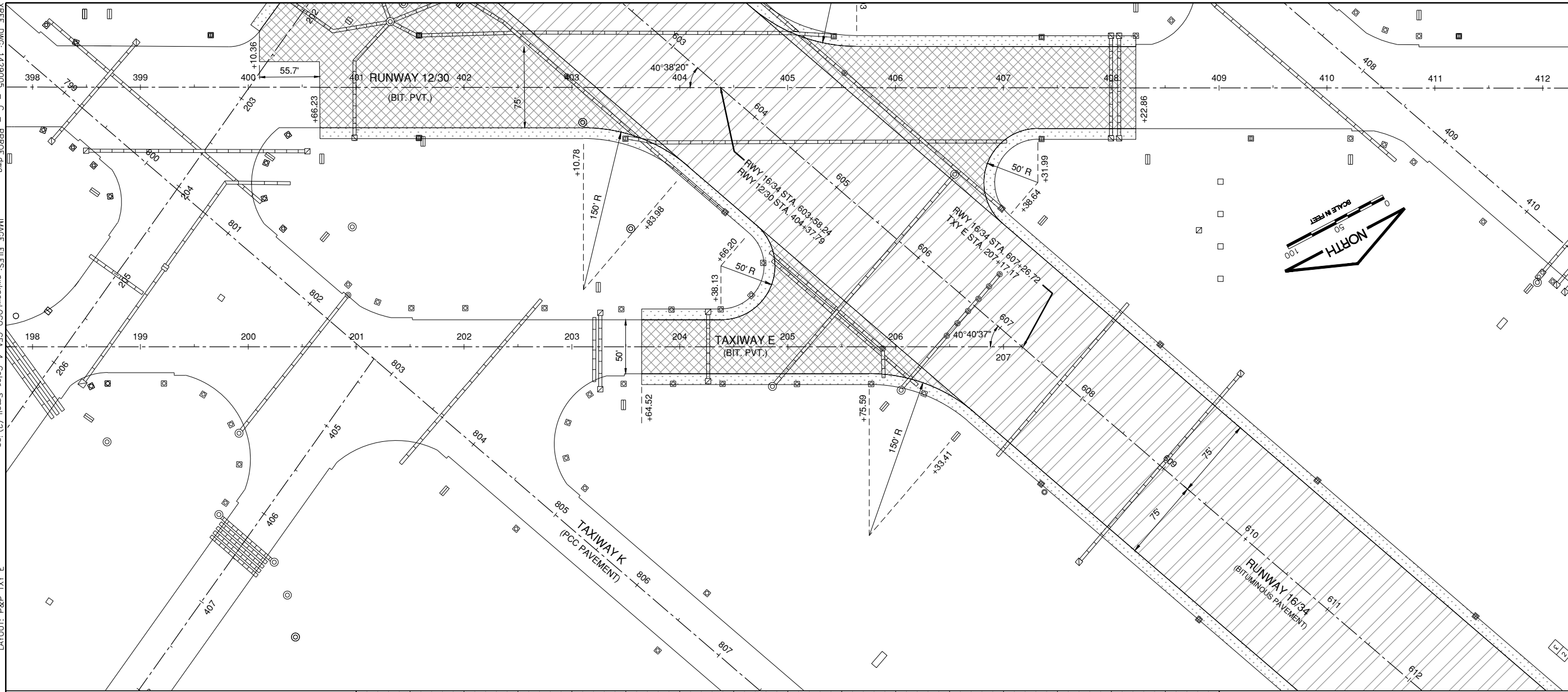

IL. CONTRACT: PA059
 IL. LETTING ITEM: 18A
 IL. PROJECT: PWK-4414
 S.B.G. PROJECT: 3-17-SBGP-XX

SURVEY BOOK # 1302

REVISIONS		
NUMBER	BY	DATE

0 1 2
 THIS BAR IS EQUAL TO 2" AT FULL SCALE (34X22).

CHICAGO EXECUTIVE AIRPORT
 WHEELING/PROSPECT HEIGHTS, ILLINOIS
 REHABILITATE RUNWAY 16/34

TAXIWAY E PLAN AND PROFILE

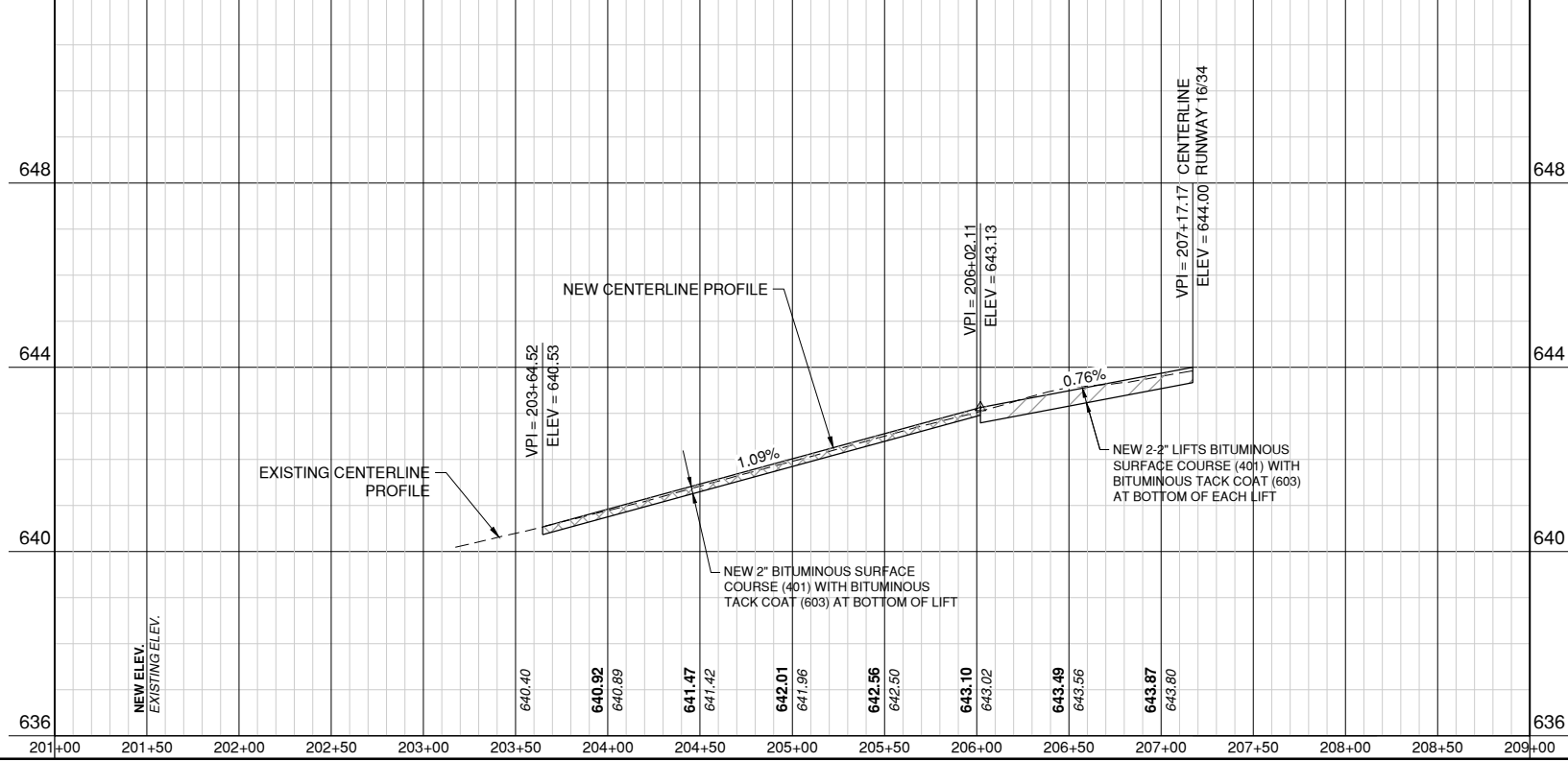
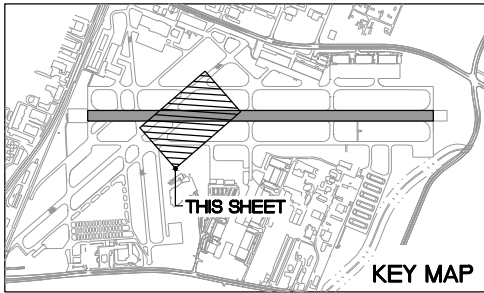

SEE RUNWAY 16/34
 PLAN AND PROFILE
 SHEET 1 FOR LEGEND

SEE RUNWAY 16/34
 PLAN AND PROFILE
 SHEETS FOR
 STRUCTURE ADJUSTMENTS

© Copyright CMT, Inc.

CMT
 CRAWFORD, MURPHY & TILLY, INC.
 CONSULTING ENGINEERS
 License No. 184-000613

CHICAGO EXECUTIVE AIRPORT

DESIGN BY: SMS
 DRAWN BY: JRO
 CHECKED BY: SMS
 APPROVED BY: DKP
 DATE: 06/19/2015
 JOB No: 14290-05-00

PRE-FINAL

SHEET 30 OF 58 SHEETS

REF: DWG: 1429005 - C - PRORF.dwg
 C:\A\Drawings\1429005.dwg
 C:\A\Drawings\1429005.dwg
 Runway 16-34 Base-NEW.dwg

UPDATE BY: Sean Smith
 DATE: 12-12-12
 IMAGE FILES: pwrnewLOGO_CEA-4-Color-Small (2).jpg

DATE: Thursday, July 9, 2015, 09:38:03
 FILE: K:\Chicago\14290-05_Rehab\16-34\Draw\Sheets\1_P&P_Rwy_12-30.dwg

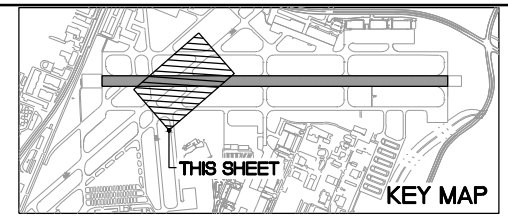
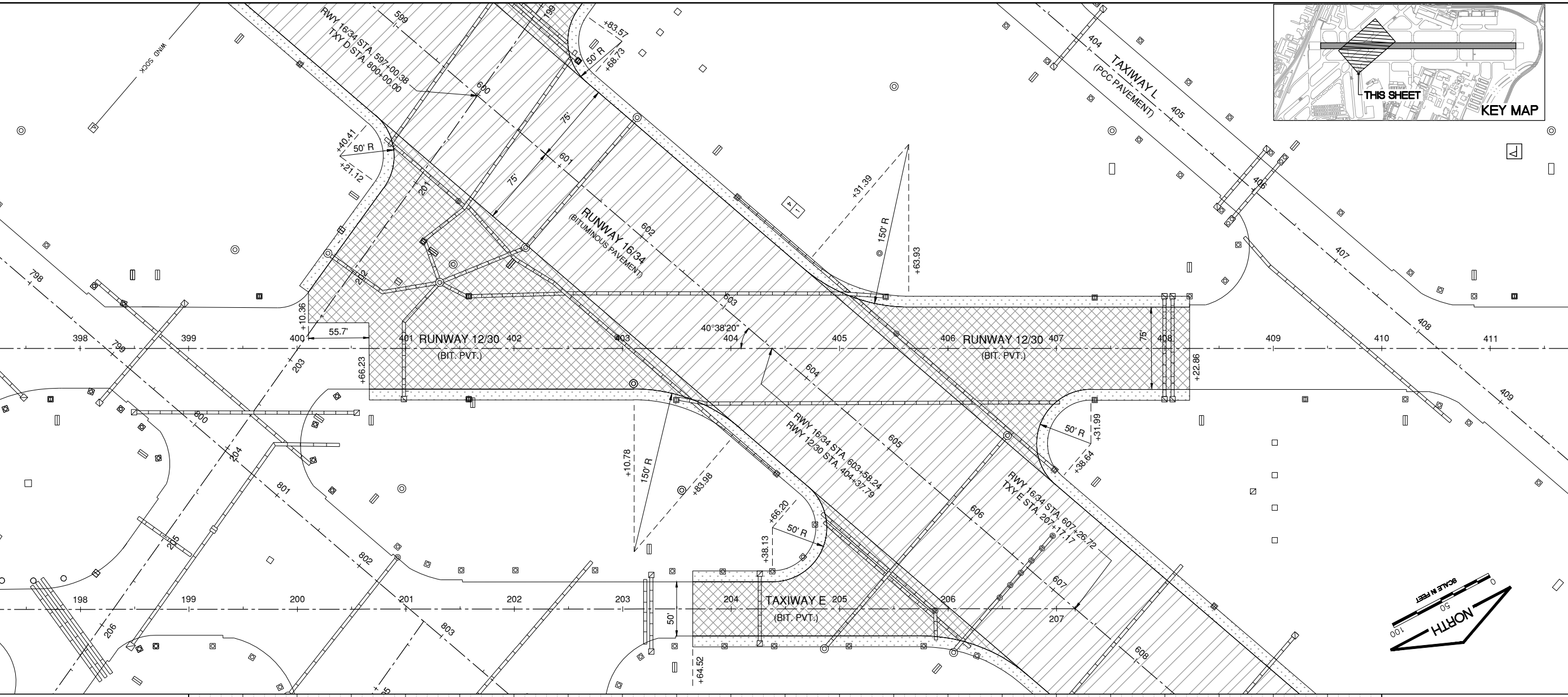

IL CONTRACT: PA059
 IL LETTING ITEM: 18A
 IL PROJECT: PWK-4414
 S.B.G. PROJECT: 3-17-SBGP-XX

SURVEY BOOK # 1302

REVISIONS		
NUMBER	BY	DATE

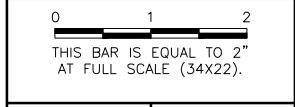

CHICAGO EXECUTIVE AIRPORT
 WHEELING/PROSPECT HEIGHTS, ILLINOIS
 REHABILITATE RUNWAY 16/34

RUNWAY 12-30 PLAN AND PROFILE

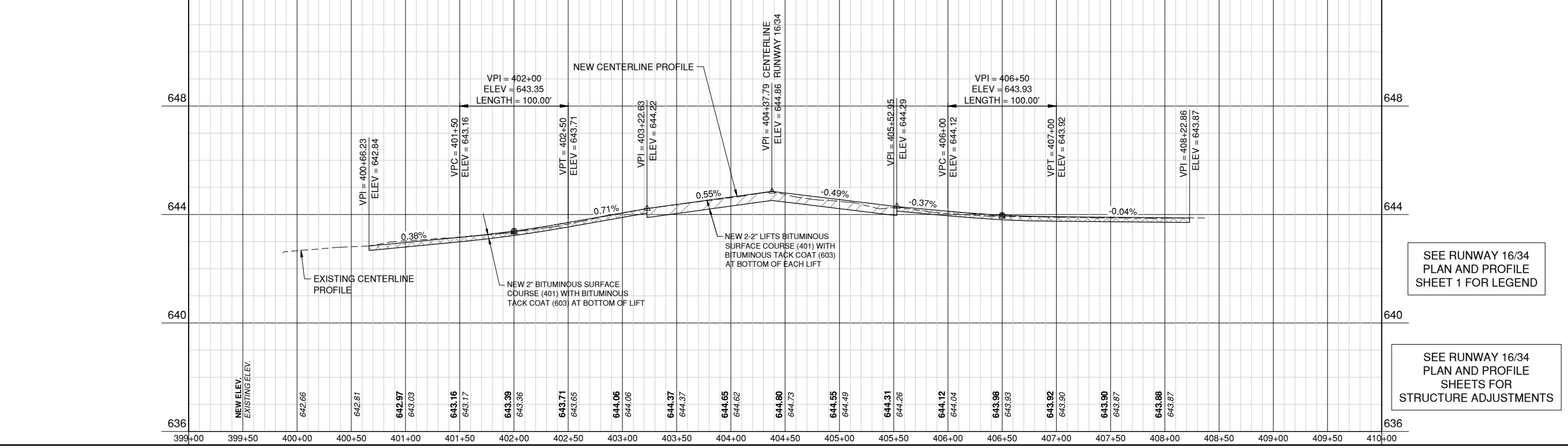

SEE RUNWAY 16/34
 PLAN AND PROFILE
 SHEET 1 FOR LEGEND

SEE RUNWAY 16/34
 PLAN AND PROFILE
 SHEETS FOR
 STRUCTURE ADJUSTMENTS

© Copyright CMT, Inc.

CMT
 CRAWFORD, MURPHY & TILLY, INC.
 CONSULTING ENGINEERS
 License No. 184-000613

CHICAGO EXECUTIVE AIRPORT

DESIGN BY:	SMS
DRAWN BY:	JRO
CHECKED BY:	SMS
APPROVED BY:	DKP
DATE:	06/19/2015
JOB No:	14290-05-00

FINAL

SHEET 31 OF 58 SHEETS

REF DWG: 1429005 - C - PROROF.dwg
 C:\Users\jmurphy\Documents\1429005.dwg
 C:\Users\jmurphy\Documents\1429005.dwg
 Runway 16-34 Base - NEW.dwg

IMAGE FILES: pwknewLOGO_CEA-4-Color-Small (2).jpg

UPDATE BY: Sean Smith
 LAYOUT: P&P_Rwy_16-34.dwg

DATE: Thursday, July 9, 2015, 09:39:05
 FILE: K:\Chicago\14290-05_Rehab\16-34\Draw\Sheets\12_P&P_Rwy_16-34.dwg

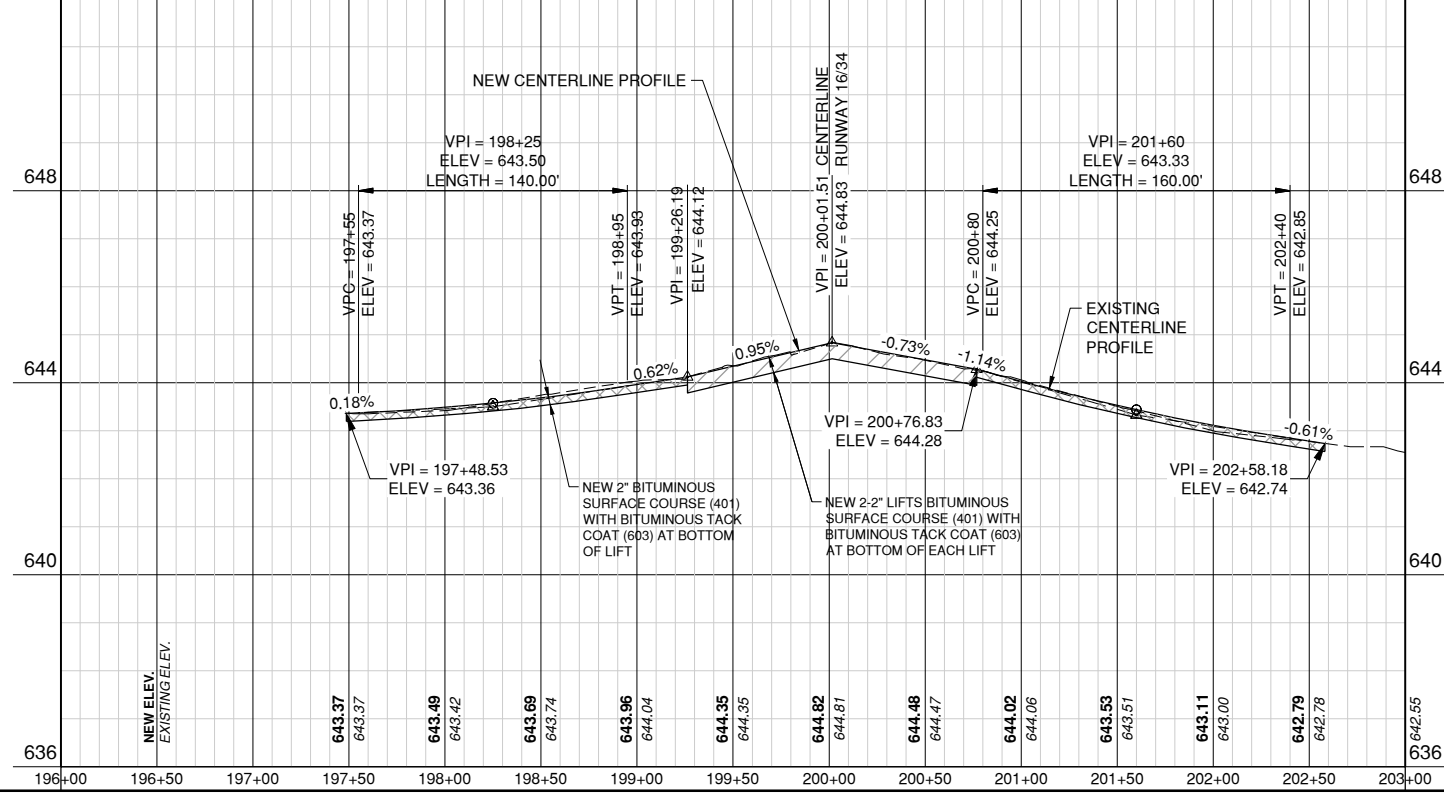
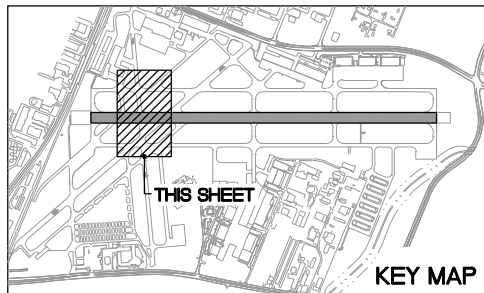
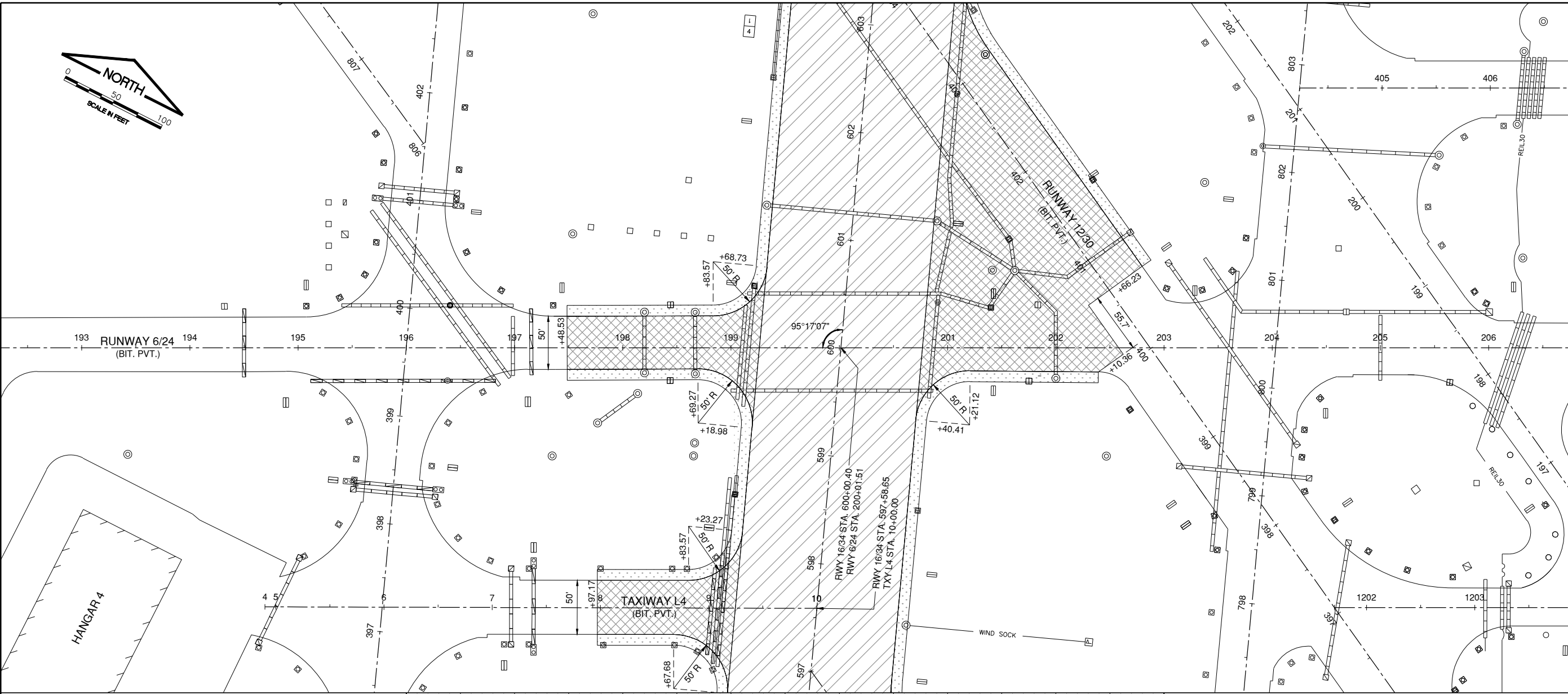
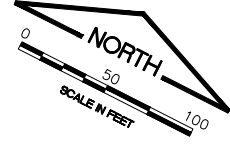

SEE RUNWAY 16/34
 PLAN AND PROFILE
 SHEET 1 FOR LEGEND

SEE RUNWAY 16/34
 PLAN AND PROFILE
 SHEETS FOR
 STRUCTURE ADJUSTMENTS

IL. CONTRACT: PA059
 IL. LETTING ITEM: 18A
 IL. PROJECT: PWK-4414
 S.B.G. PROJECT: 3-17-SBGP-XX

SURVEY BOOK # 1302

REVISIONS		
NUMBER	BY	DATE

0 1 2
 THIS BAR IS EQUAL TO 2"
 AT FULL SCALE (34X22).

CHICAGO EXECUTIVE AIRPORT
 WHEELING/PROSPECT HEIGHTS, ILLINOIS
 REHABILITATE RUNWAY 16/34

RUNWAY 6-24 PLAN AND PROFILE

© Copyright CMT, Inc.



DESIGN BY: SMS
 DRAWN BY: JRO
 CHECKED BY: SMS
 APPROVED BY: DKP
 DATE: 06/19/2015
 JOB No: 14290-05-00

FINAL

REF: DWG: 142905 C - PRORF.dwg
 C:\Users\m_j_rice\OneDrive\Documents\142905-05-REHAB\16-34\Draw\16-34.dwg
 Update: 16-34.dwg - NEW.dwg

IMAGE FILES: pwknewLOGO_CEA-4-Color-Small (2).jpg

UPDATE BY: Sean Smith
 LAYOUT: P&P_TXY_L4

DATE: Thursday, July 9, 2015, 09:40:13
 FILE: K:\Chicago\142905-05-REHAB\16-34\Draw\16-34.dwg

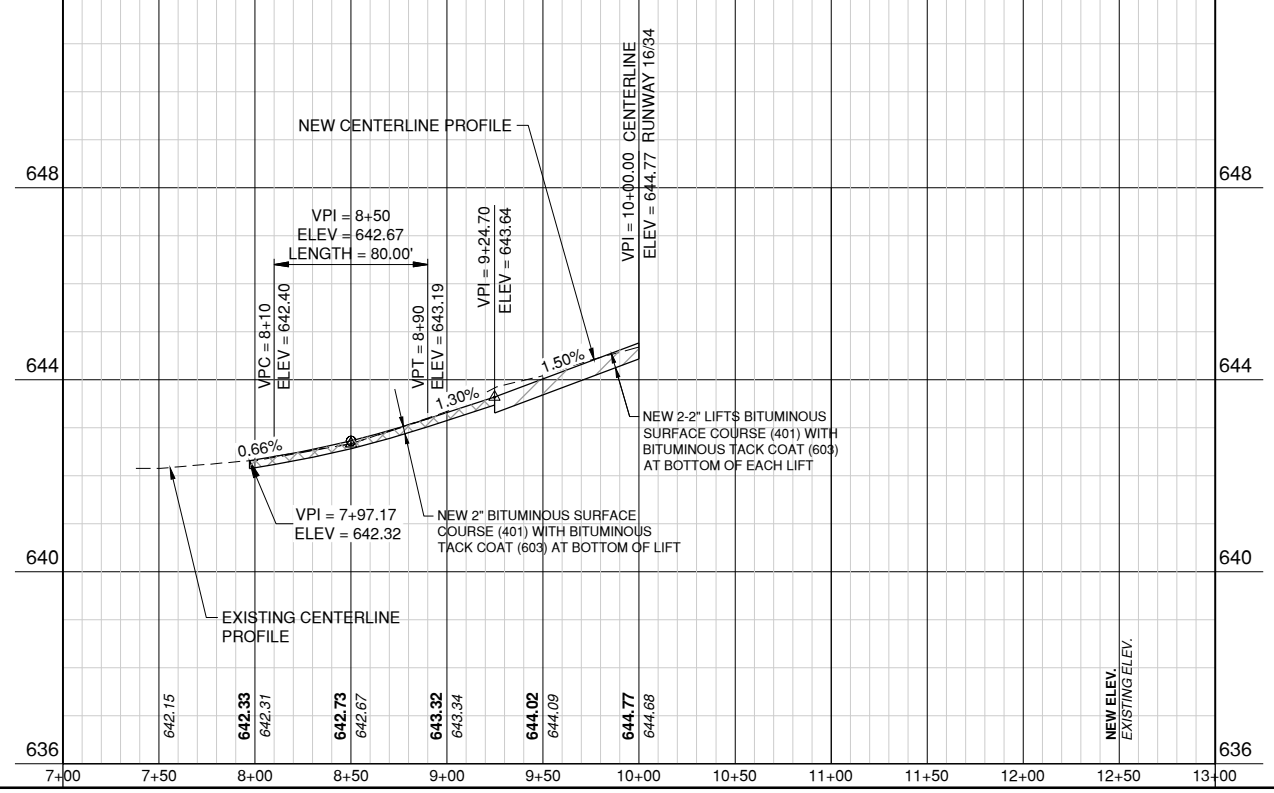
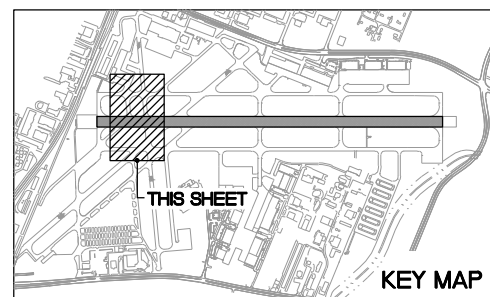
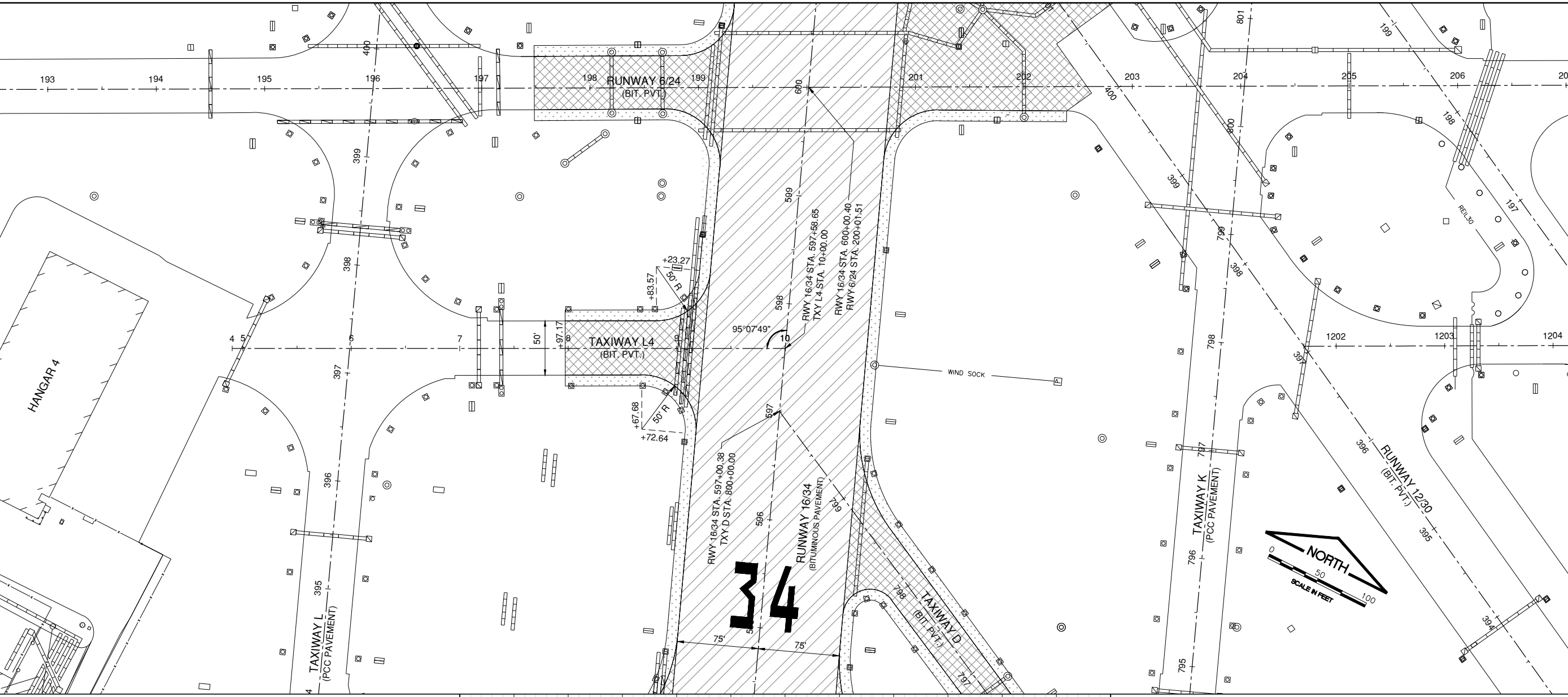

SEE RUNWAY 16/34
 PLAN AND PROFILE
 SHEET 1 FOR LEGEND

SEE RUNWAY 16/34
 PLAN AND PROFILE
 SHEETS FOR
 STRUCTURE ADJUSTMENTS

IL CONTRACT: PA059
 IL LETTING ITEM: 18A
 IL PROJECT: PWK-4414
 S.B.G. PROJECT: 3-17-SBGP-XX

SURVEY BOOK # 1302

REVISIONS		
NUMBER	BY	DATE

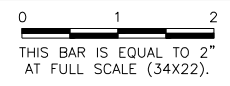

CHICAGO EXECUTIVE AIRPORT
 WHEELING/PROSPECT HEIGHTS, ILLINOIS
 REHABILITATE RUNWAY 16/34

TAXIWAY L4 PLAN AND PROFILE

© Copyright CMT, Inc.

CMT
 CRAWFORD, MURPHY & TILLY, INC.
 CONSULTING ENGINEERS
 License No. 184-000613

CHICAGO EXECUTIVE AIRPORT

DESIGN BY:	SMS
DRAWN BY:	JRO
CHECKED BY:	SMS
APPROVED BY:	DKP
DATE:	06/19/2015
JOB No:	14290-05-00

FINAL

SHEET 33 OF 58 SHEETS

REF: DWG: 1429005 - C - PROROF.dwg
 C:\A\Drawings\1429005.dwg
 C:\A\Drawings\1429005.dwg
 C:\A\Drawings\1429005.dwg
 C:\A\Drawings\1429005.dwg

IMAGE FILES: pwknewLOGO_CEA-4-Color-Small (2).jpg

UPDATE BY: Sean Smith
 LAYOUT: P&P_TAXI D

DATE: Thursday, July 9, 2015, 09:41:15
 FILE: K:\Chicago\1429005-05_Renovation\16-34_Draw\Sheets\34_P&P_TAXI D.dwg

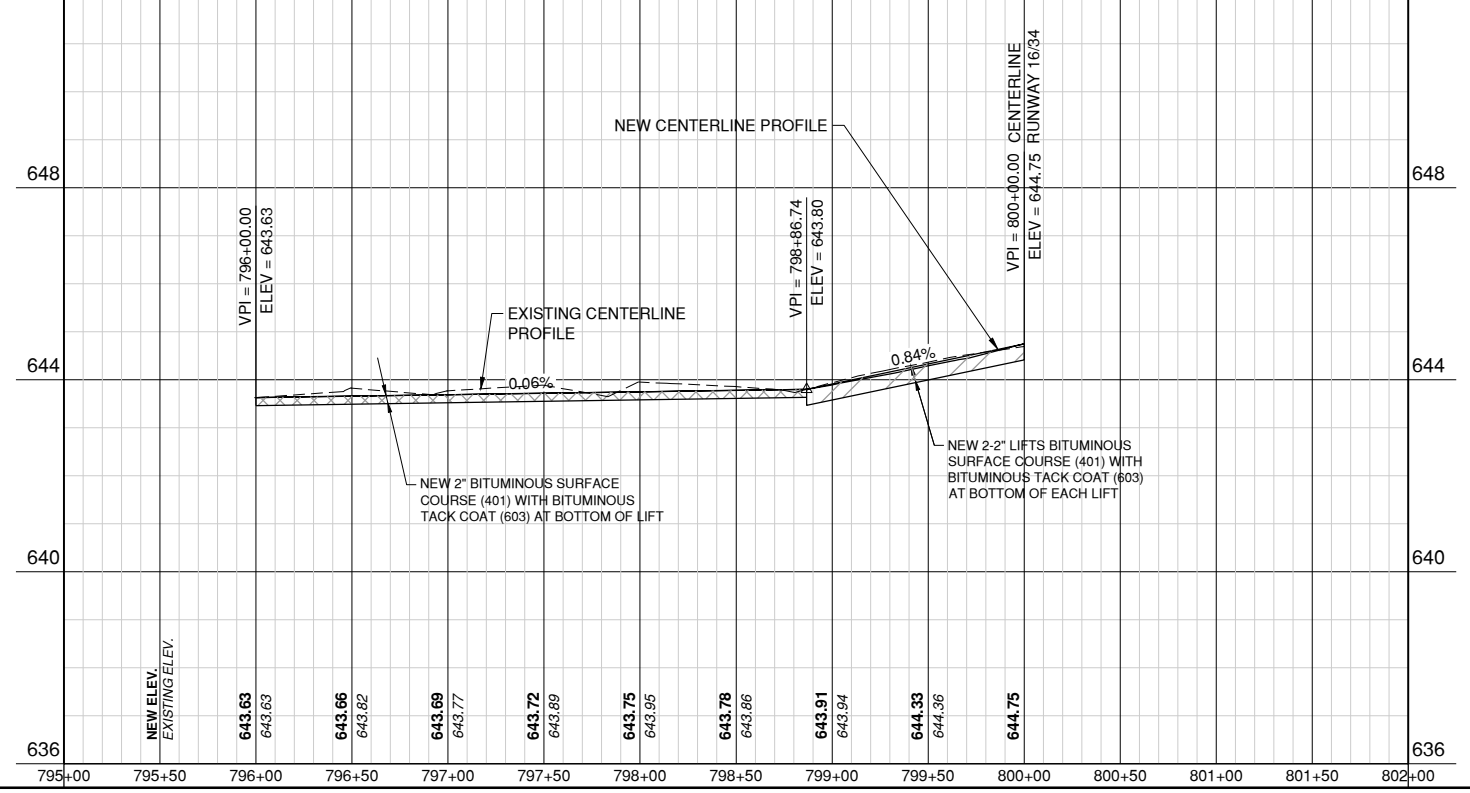
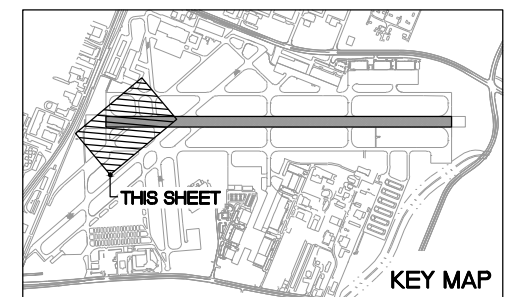
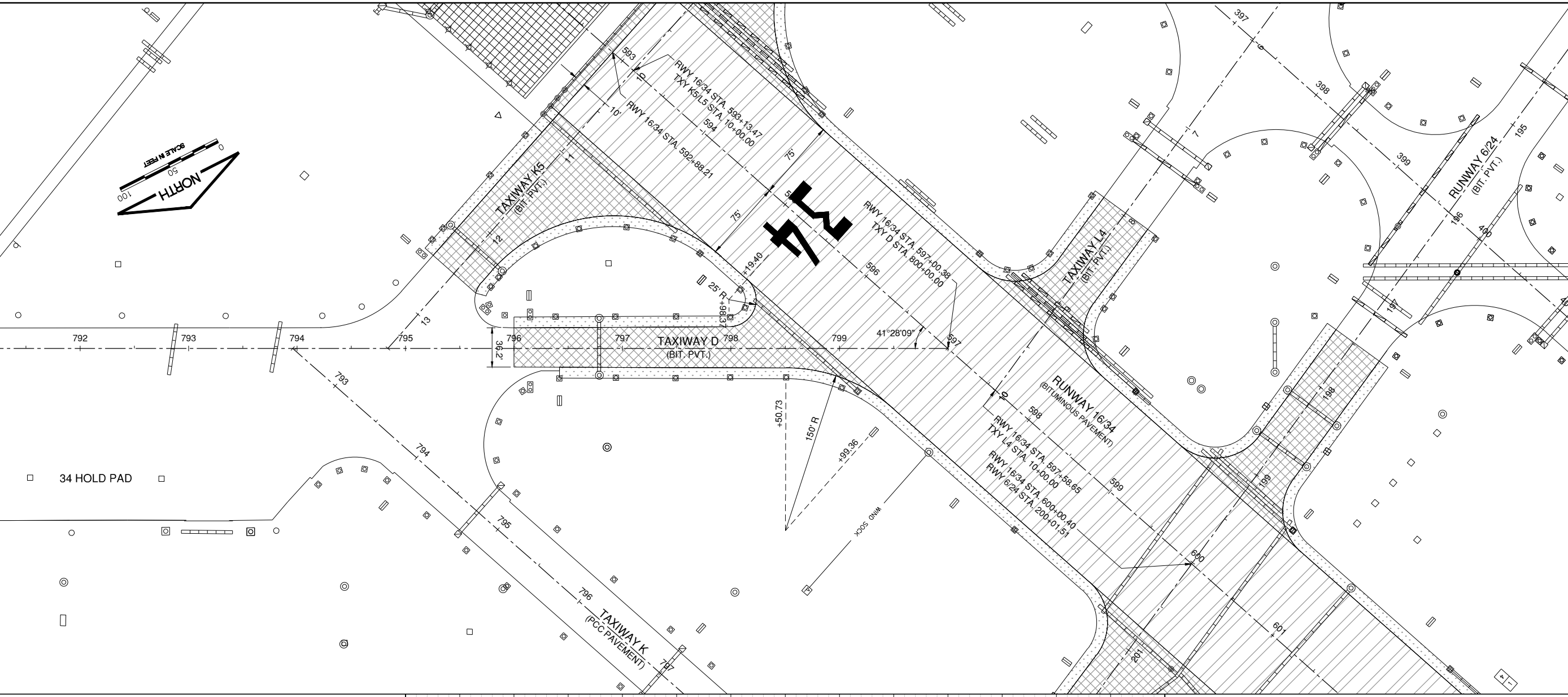

SEE RUNWAY 16/34
 PLAN AND PROFILE
 SHEET 1 FOR LEGEND

SEE RUNWAY 16/34
 PLAN AND PROFILE
 SHEETS FOR
 STRUCTURE ADJUSTMENTS

IL. CONTRACT: PA059
 IL. LETTING ITEM: 18A
 IL. PROJECT: PWK-4414
 S.B.G. PROJECT: 3-17-SBGP-XX

SURVEY BOOK # 1302

REVISIONS		
NUMBER	BY	DATE

0 1 2
 THIS BAR IS EQUAL TO 2"
 AT FULL SCALE (34X22).

CHICAGO EXECUTIVE AIRPORT
 WHEELING/PROSPECT HEIGHTS, ILLINOIS
 REHABILITATE RUNWAY 16/34

TAXIWAY D PLAN AND PROFILE

© Copyright CMT, Inc.

CMT
 CRAWFORD, MURPHY & TILLY, INC.
 CONSULTING ENGINEERS
 License No. 184-000613

CHICAGO EXECUTIVE AIRPORT

DESIGN BY:	SMS
DRAWN BY:	JRO
CHECKED BY:	SMS
APPROVED BY:	DKP
DATE:	06/19/2015
JOB No:	14290-05-00

FINAL

SHEET 34 OF 58 SHEETS

REF: DWG: 1429005 C PROROF.dwg
 C:\Users\mroy_l\csd\dwg
 C:\Users\mroy_l\csd\dwg
 Runway 16-34 base-NEW.dwg

UPDATE BY: Sean Smith
 LAYOUT: P&P_TY_K5

DATE: Thursday, July 9, 2015, 09:42:28
 FILE: K:\Chicago\ref\14290-05_RehabRWY16-34\Draw\Sheets\35_P&P_TY_K5.dwg

IMAGE FILES: pwrnew\LOGO_CEA-4-Color-Small (2).jpg

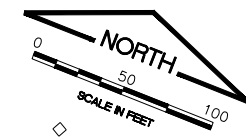
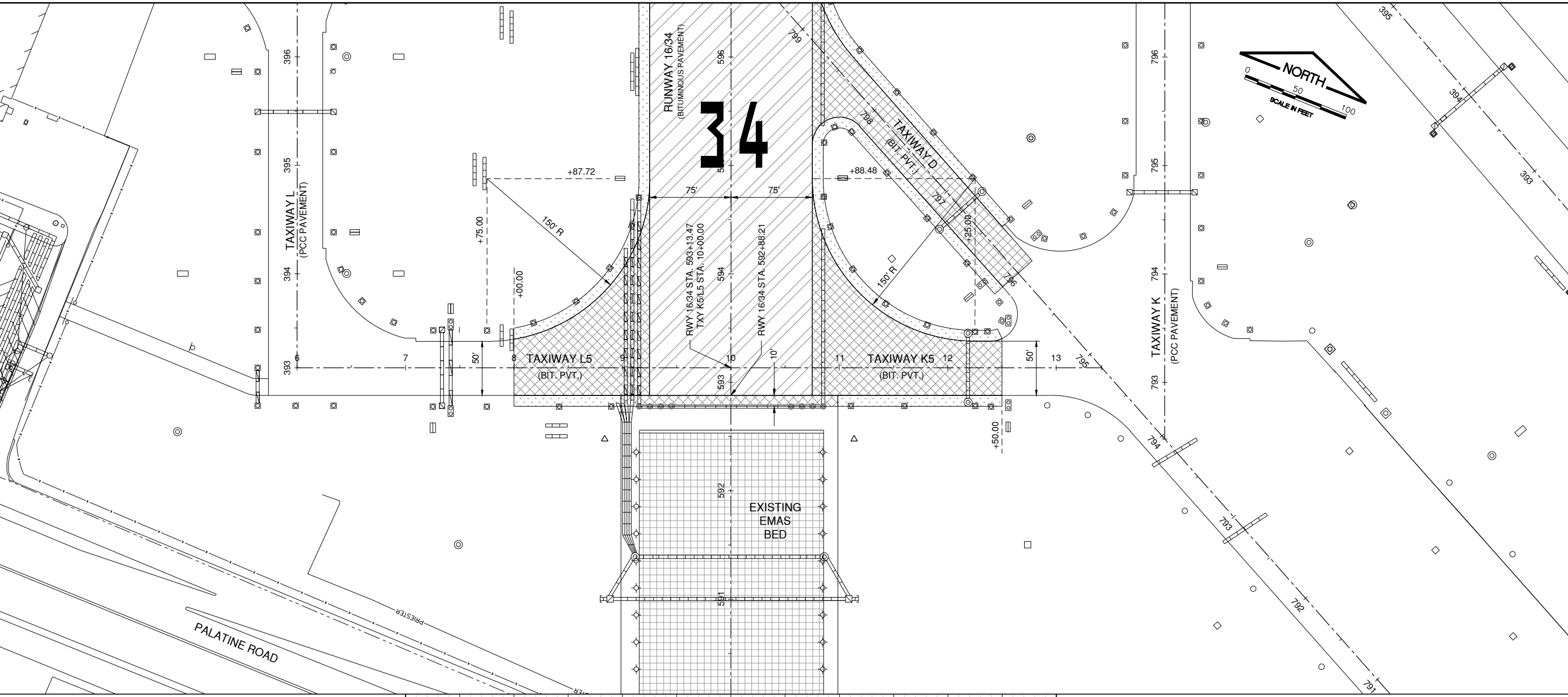

IL. CONTRACT: PA059
 IL. LETTING ITEM: 18A
 IL. PROJECT: PWK-4414
 S.B.G. PROJECT: 3-17-SBGP-XX

SURVEY BOOK # 1302

REVISIONS		
NUMBER	BY	DATE

0 1 2
 THIS BAR IS EQUAL TO 2"
 AT FULL SCALE (34X22).

**CHICAGO EXECUTIVE AIRPORT
 WHEELING/PROSPECT HEIGHTS, ILLINOIS
 REHABILITATE RUNWAY 16/34**

TAXIWAY K5 AND L5 PLAN AND PROFILE

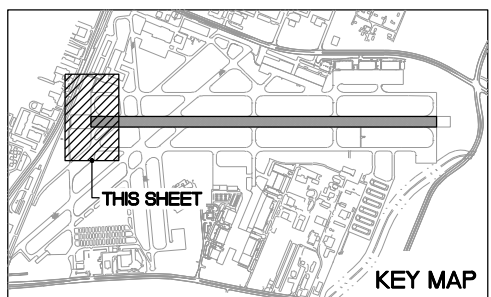
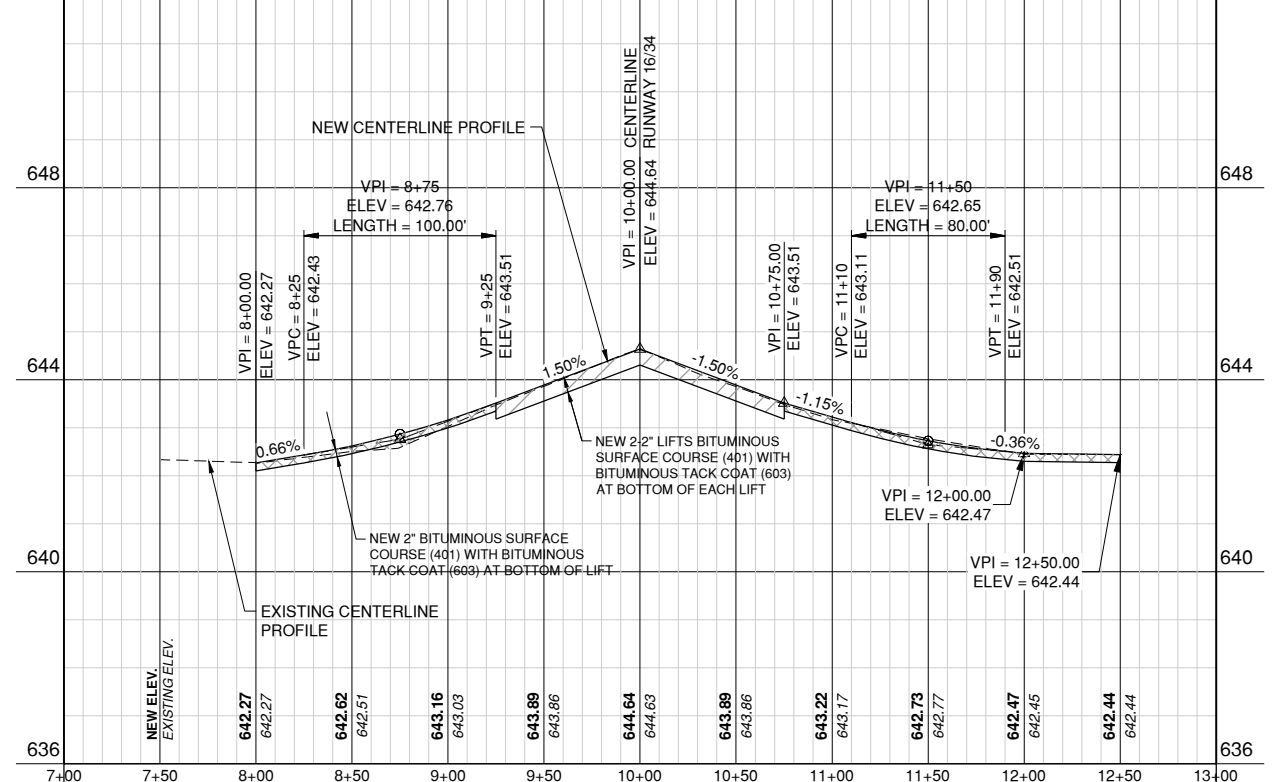

SEE RUNWAY 16/34
 PLAN AND PROFILE
 SHEET 1 FOR LEGEND

SEE RUNWAY 16/34
 PLAN AND PROFILE
 SHEETS FOR
 STRUCTURE ADJUSTMENTS

© Copyright CMT, Inc.

CMT
 CRAWFORD, MURPHY & TILLY, INC.
 CONSULTING ENGINEERS
 License No. 184-000613

CHICAGO EXECUTIVE AIRPORT

DESIGN BY:	SMS
DRAWN BY:	JRO
CHECKED BY:	SMS
APPROVED BY:	DKP
DATE:	06/19/2015
JOB No:	14290-05-00

FINAL

DATE: Thursday, July 9, 2015, 12:56:07
 FILE: K:\Chicago\edg\14290-05-Rev\AIR16-3A\Draw\Sheet\16-39 INTERSECTION PLAN.dwg
 UPDATE BY: Sean Smith
 NAYOUT: INT PLAN
 IMAGE FILES: pwk\m\LOGO_GEA-4-Color-Small (2).jpg
 REF DWG: runway_16-34 base-NEW.dwg
 TECH: runway.dwg

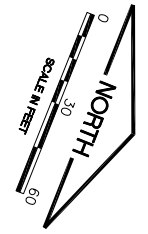
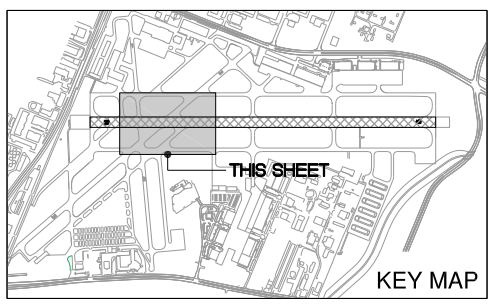
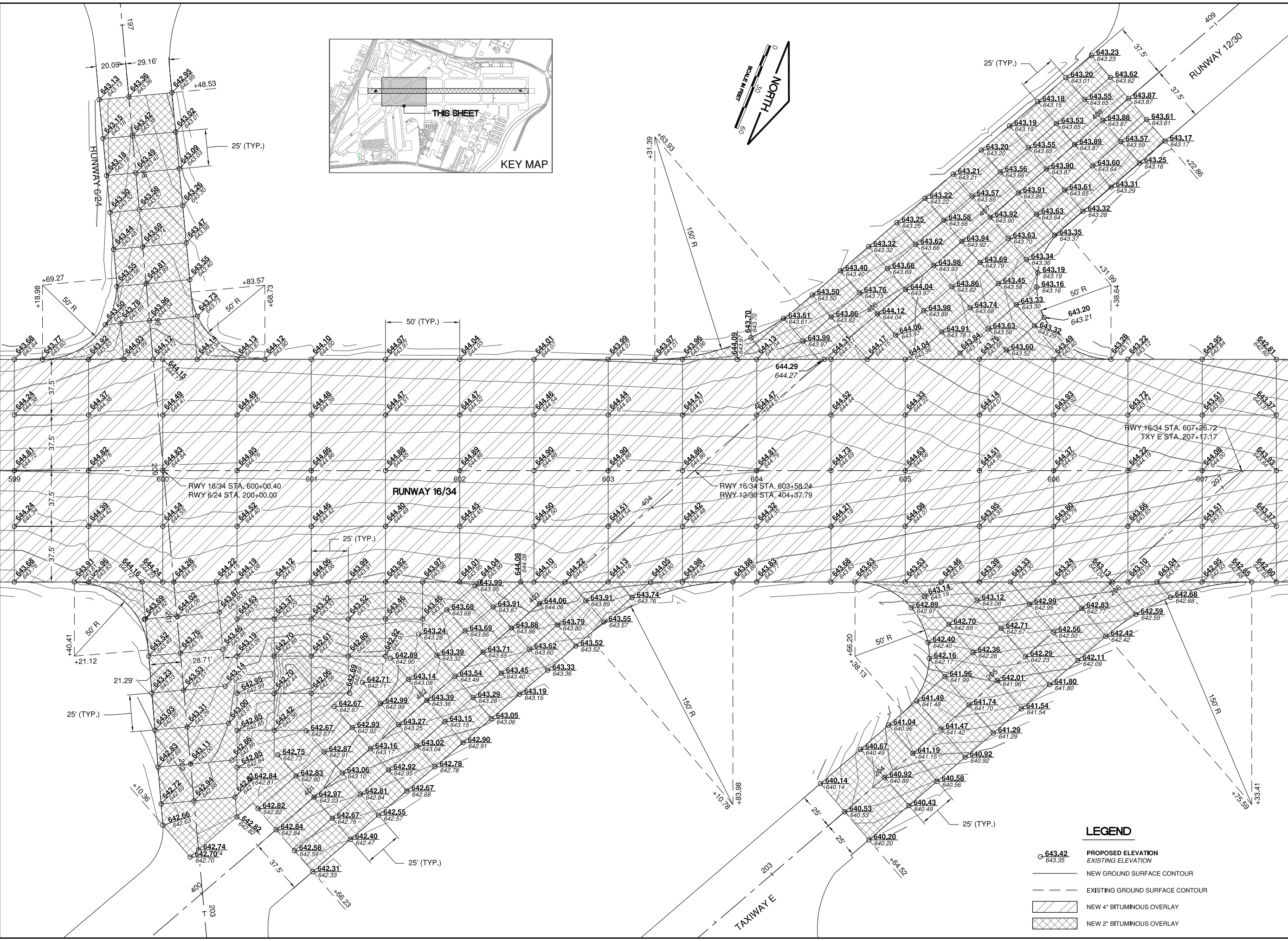

IL CONTRACT: PA059
 IL LETTING ITEM: 18A
 IL PROJECT: PWK-4414
 S.B.G. PROJECT: 3-17-SBGP-XX

SURVEY BOOK # 1302

REVISIONS		
NUMBER	BY	DATE

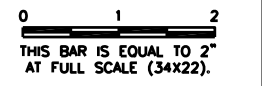

**CHICAGO EXECUTIVE AIRPORT
 WHEELING/PROSPECT HEIGHTS, ILLINOIS
 REHABILITATE RUNWAY 16/34**

**INTERSECTION GRADING PLAN
 RUNWAYS 6/24, 12/30 AND 16/34**

© Copyright CMT, Inc.

CMT
 CRAWFORD MURPHY & TILLY, INC.
 CONSULTING ENGINEERS
 License No. 184-000613

DESIGN BY:	SMS
DRAWN BY:	JRO
CHECKED BY:	SMS
APPROVED BY:	DKP
DATE:	06/19/2015
JOB No:	14290-05-00

FINAL

- LEGEND**
- 643.42
643.35 PROPOSED ELEVATION
 - EXISTING ELEVATION
 - NEW GROUND SURFACE CONTOUR
 - - - EXISTING GROUND SURFACE CONTOUR
 - ▨ NEW 4" BITUMINOUS OVERLAY
 - ▩ NEW 2" BITUMINOUS OVERLAY

DATE: Thursday, July 9, 2015, 13:00:22
 FILE: K:\Chicago\cedeg\14290-05_RetainRW16-5A\Draw\Sheets\36-39_INTERSECTION_Plan.dwg
 UPDATE BY: Sean Smith
 LAYOUT: INT_K5&L5
 IMAGE FILES: pwkrunwaylogo_cga-4-COLOR-Small (2).jpg
 REF DWG: runway_16-34_base-NEW.dwg
 BENCH: runway.dwg

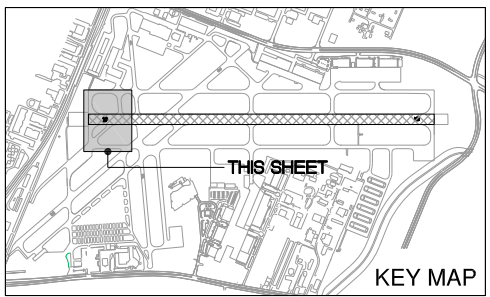
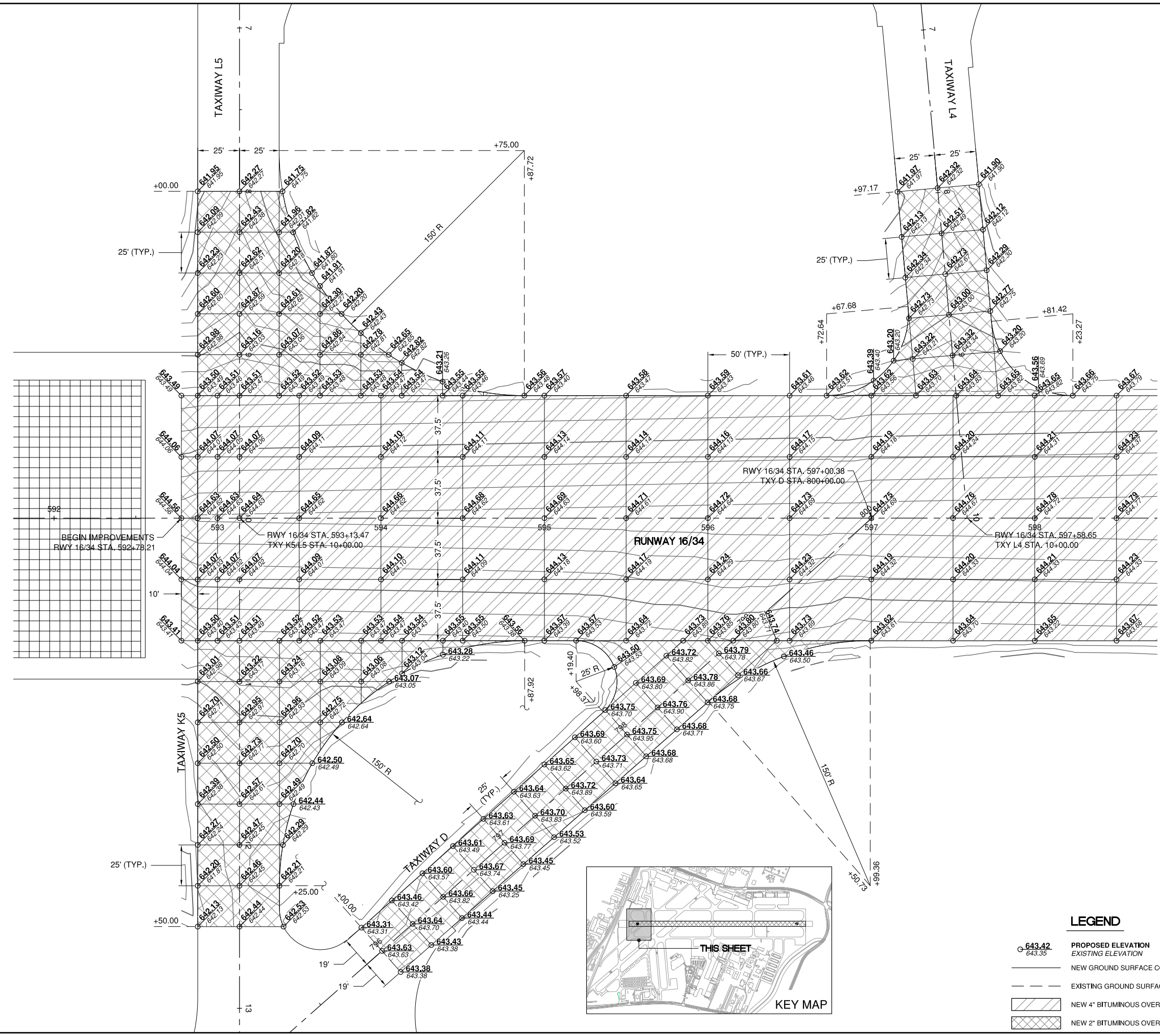

LEGEND

- 643.42
643.35 PROPOSED ELEVATION
- NEW GROUND SURFACE CONTOUR
- - - EXISTING GROUND SURFACE CONTOUR
- ▨ NEW 4" BITUMINOUS OVERLAY
- ▩ NEW 2" BITUMINOUS OVERLAY

IL CONTRACT: PA059
 IL LETTING ITEM: 18A
 IL PROJECT: PWK-4414
 S.B.G. PROJECT: 3-17-SBGP-XX

SURVEY BOOK # 1302

REVISIONS		
NUMBER	BY	DATE

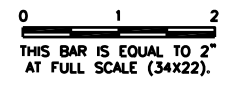

**CHICAGO EXECUTIVE AIRPORT
 WHEELING/PROSPECT HEIGHTS, ILLINOIS
 REHABILITATE RUNWAY 16/34
 INTERSECTION GRADING PLAN
 TAXIWAYS D, L4, K5 AND L5**

© Copyright CMT, Inc.

CMT
 CRAWFORD, MURPHY & TILLY, INC.
 CONSULTING ENGINEERS
 License No. 184-000613

CHICAGO EXECUTIVE AIRPORT

DESIGN BY:	SMS
DRAWN BY:	JRO
CHECKED BY:	SMS
APPROVED BY:	DKP
DATE:	06/19/2015
JOB No:	14290-05-00

FINAL

DATE: Thursday, July 9, 2015 09:43:22
 FILE: K:\Chicago\check\14290-05_Rehab\RW16-5A\Draw\Sheets\36-39 INTERSECTION PLAN.dwg
 UPDATE BY: Sean Smith
 LAYOUT: INT K3 AND K2
 IMAGE FILES: pwknewLOGO_CEA-4-Color-Small (2).jpg
 REF DWG: runway_16-34 base-NEW.dwg
 bchm_rumovj.dwg

**INTERSECTION GRADING PLAN
TAXIWAYS K3 AND L3**

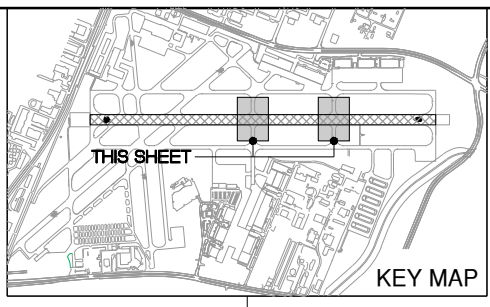
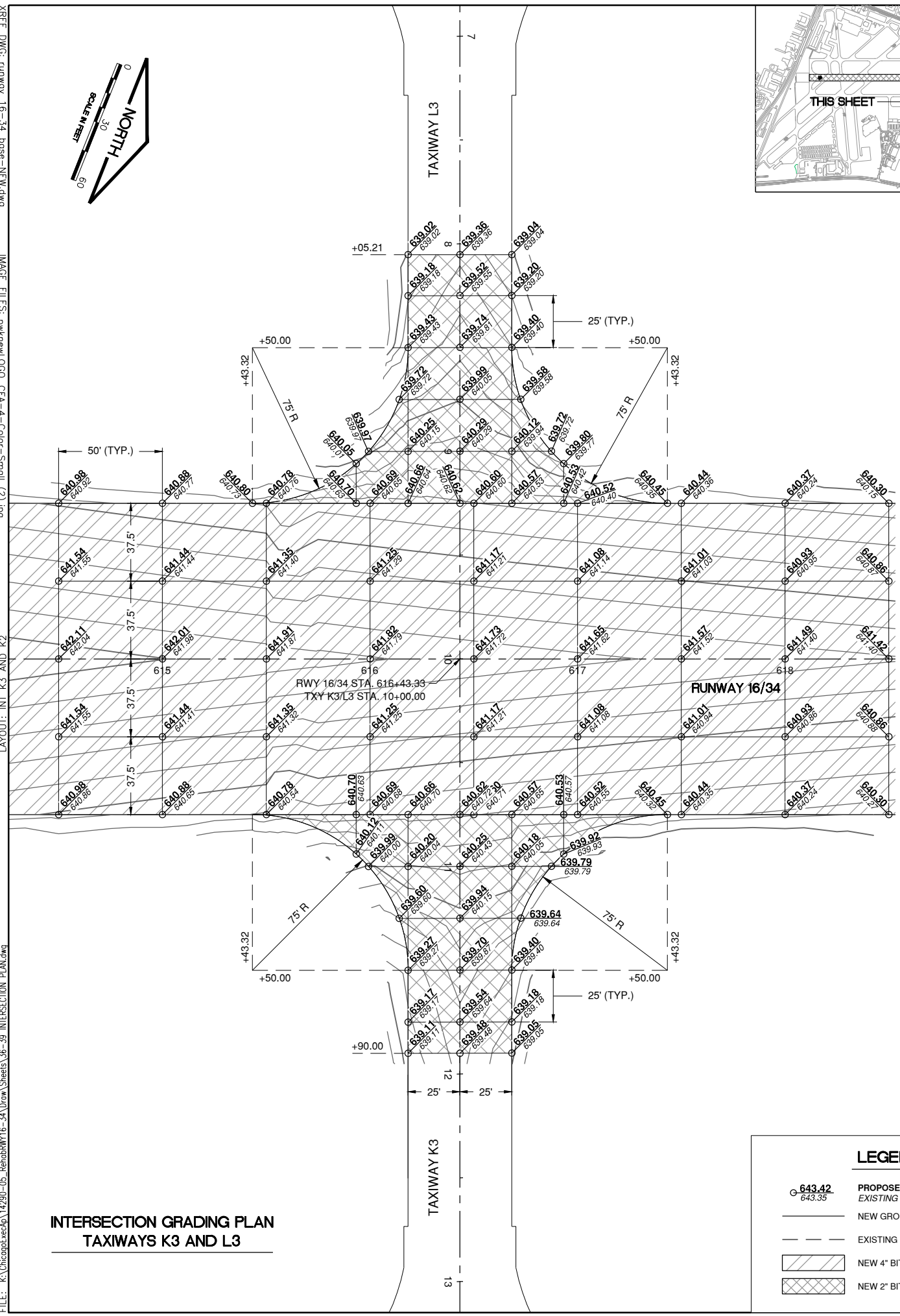

LEGEND

- 643.42
643.35 PROPOSED ELEVATION
- 643.35 EXISTING ELEVATION
- NEW GROUND SURFACE CONTOUR
- - - EXISTING GROUND SURFACE CONTOUR
- ▨ NEW 4" BITUMINOUS OVERLAY
- ▩ NEW 2" BITUMINOUS OVERLAY

**INTERSECTION GRADING PLAN
TAXIWAYS K2 AND L2**

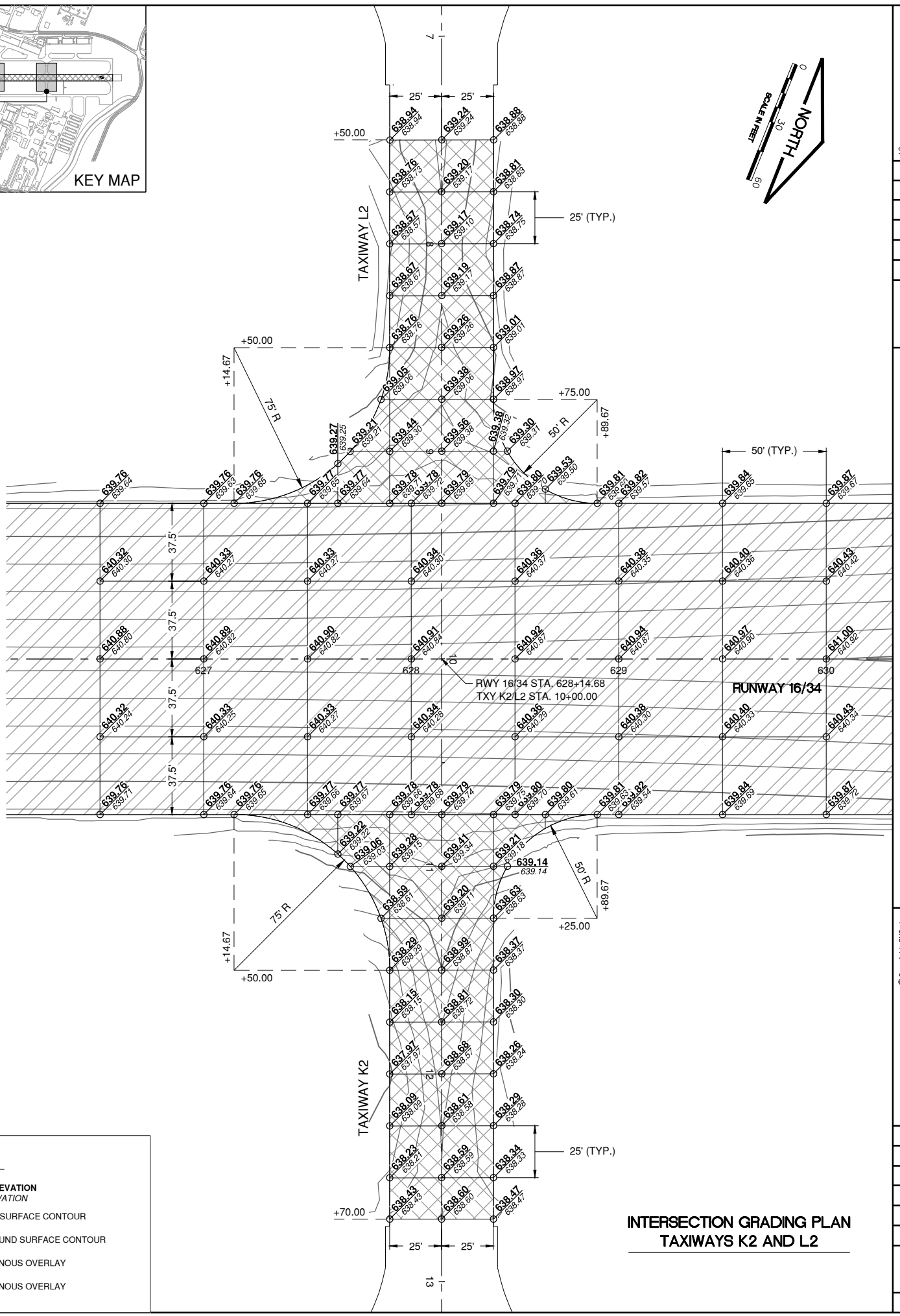

IL. CONTRACT: PA059
 IL. LETTING ITEM: 18A
 IL. PROJECT: PWK-4414
 S.B.G. PROJECT: 3-17-SBGP-XX

SURVEY BOOK # 1302

REVISIONS		
NUMBER	BY	DATE

0 1 2
 THIS BAR IS EQUAL TO 2" AT FULL SCALE (34x22).

**CHICAGO EXECUTIVE AIRPORT
WHEELING/PROSPECT HEIGHTS, ILLINOIS
REHABILITATE RUNWAY 16/34**

**INTERSECTION GRADING PLAN
TAXIWAYS K2, L2, K3 AND L3**

© Copyright CMT, Inc.

CMT
 CRAWFORD, MURPHY & TILLY, INC.
 CONSULTING ENGINEERS
 License No. 184-000613

CHICAGO EXECUTIVE AIRPORT

DESIGN BY:	SMS
DRAWN BY:	JRO
CHECKED BY:	SMS
APPROVED BY:	DKP
DATE:	06/19/2015
JOB No:	14290-05-00
FINAL	
SHEET	38 OF 58 SHEETS

DATE: Thursday, July 9, 2015 09:43:28
 FILE: K:\Chicago\check\14290-05_Renov\RWY16-34\Draw\Sheets\16-34\Draw\Sheet\16-34-39 INTERSECTION PLAN.dwg
 UPDATE BY: Sean Smith
 LAYOUT: INT_K-L
 IMAGE FILES: pwknewLOGO_CEA-4-Color-Small (2).jpg
 REF: DWG: runway_16-34_base-NEW.dwg
 bchm_runway.dwg

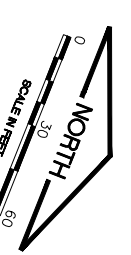
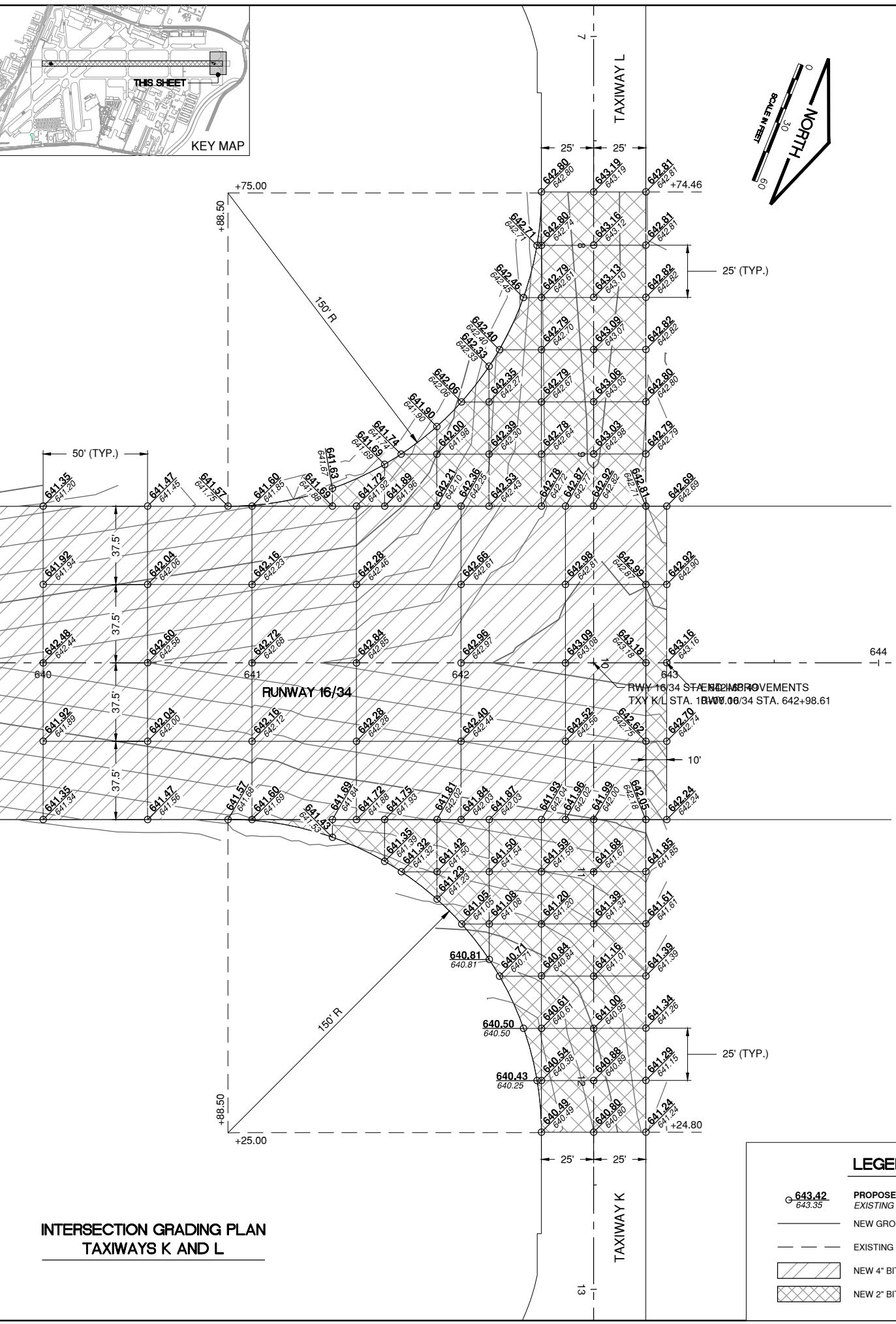

**INTERSECTION GRADING PLAN
 TAXIWAYS K AND L**

LEGEND

	643.42 643.35	PROPOSED ELEVATION
		EXISTING ELEVATION
		NEW GROUND SURFACE CONTOUR
		EXISTING GROUND SURFACE CONTOUR
		NEW 4" BITUMINOUS OVERLAY
		NEW 2" BITUMINOUS OVERLAY

IL. CONTRACT: **PA059**
 IL. LETTING ITEM: **18A**
 IL. PROJECT: **PWK-4414**
 S.B.G. PROJECT: **3-17-SBGP-XX**

SURVEY BOOK # 1302

REVISIONS

NUMBER	BY	DATE

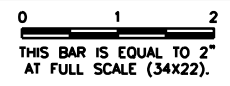

**CHICAGO EXECUTIVE AIRPORT
 WHEELING/PROSPECT HEIGHTS, ILLINOIS
 REHABILITATE RUNWAY 16/34**

**INTERSECTION GRADING PLAN
 TAXIWAYS K AND L**

© Copyright CMT, Inc.

CMT
 CRAWFORD, MURPHY & TILLY, INC.
 CONSULTING ENGINEERS
 License No. 184-000613

CHICAGO EXECUTIVE AIRPORT

DESIGN BY:	SMS
DRAWN BY:	JRO
CHECKED BY:	SMS
APPROVED BY:	DKP
DATE:	06/19/2015
JOB No:	14290-05-00

FINAL

SHEET 39 OF 58 SHEETS

DATE: Thursday, July 9, 2015 09:43:59
FILE: K:\Chicago\Rehab\14290-05_RehabRW16-34_Drvn_Sheets\40_MILL TABLE.dwg
UPDATE BY: Sean Smith
LAYOUT: MILL TABLE
IMAGE FILES: pwknewLOGO_CEA-4-Color-Small (2).pdf
XREF DWG: bchml_rumw01.dwg

BITUMINOUS PAVEMENT MILLING (AR401650) - MILLING DEPTHS															
STATION	75' LEFT OF CENTERLINE			37.5' LEFT OF CENTERLINE			CENTERLINE			37.5' RIGHT OF CENTERLINE			75' RIGHT OF CENTERLINE		
	PROP. ELEV.	EXST. ELEV.	MILL DEPTH	PROP. ELEV.	EXST. ELEV.	MILL DEPTH	PROP. ELEV.	EXST. ELEV.	MILL DEPTH	PROP. ELEV.	EXST. ELEV.	MILL DEPTH	PROP. ELEV.	EXST. ELEV.	MILL DEPTH
592+88.21	643.51	643.49	0.31	644.07	644.07	0.33	644.63	644.62	0.32	644.07	644.03	0.29	643.51	643.40	0.23
593+50	643.52	643.49	0.30	644.09	644.11	0.36	644.65	644.62	0.31	644.09	644.07	0.32	643.52	643.47	0.27
594+00	643.54	643.47	0.27	644.10	644.12	0.35	644.66	644.62	0.28	644.10	644.10	0.33	643.54	643.47	0.26
594+50	643.55	643.46	0.24	644.11	644.11	0.33	644.68	644.62	0.27	644.11	644.09	0.31	643.55	643.50	0.28
595+00	643.57	643.40	0.16	644.13	644.14	0.35	644.69	644.63	0.27	644.13	644.18	0.38	643.57	643.39	0.16
595+50	643.58	643.47	0.22	644.14	644.14	0.33	644.71	644.61	0.23	644.17	644.19	0.35	643.64	643.72	0.41
596+00	643.60	643.43	0.17	644.16	644.13	0.30	644.72	644.64	0.25	644.24	644.29	0.38	643.76	643.85	0.42
596+50	643.61	643.46	0.18	644.17	644.15	0.31	644.73	644.69	0.29	644.23	644.32	0.42	643.73	643.69	0.28
597+00	643.62	643.56	0.27	644.19	644.19	0.33	644.75	644.69	0.27	644.19	644.32	0.47	643.62	643.61	0.32
597+50	643.64	643.81	0.51	644.20	644.24	0.37	644.76	644.67	0.24	644.20	644.33	0.46	643.64	643.70	0.39
598+00	643.65	643.82	0.50	644.22	644.31	0.42	644.78	644.72	0.27	644.22	644.33	0.45	643.65	643.22	0.00
598+50	643.67	643.79	0.46	644.23	644.38	0.48	644.79	644.77	0.31	644.23	644.33	0.43	643.67	643.68	0.35
599+00	643.68	643.64	0.29	644.24	644.38	0.47	644.81	644.72	0.25	644.24	644.34	0.43	643.68	643.76	0.41
599+50	643.92	643.83	0.24	644.37	644.38	0.34	644.82	644.76	0.27	644.39	644.42	0.36	643.96	643.83	0.20
600+00	644.15	644.17	0.35	644.49	644.47	0.30	644.84	644.84	0.33	644.54	644.55	0.35	644.24	644.23	0.32
600+50	644.13	643.88	0.08	644.49	644.45	0.29	644.85	644.76	0.24	644.52	644.40	0.21	644.19	644.08	0.22
601+00	644.10	644.00	0.23	644.48	644.39	0.24	644.86	644.86	0.32	644.46	644.42	0.29	644.06	644.06	0.34
601+50	644.07	643.97	0.23	644.47	644.51	0.37	644.88	644.85	0.30	644.40	644.49	0.42	643.92	643.92	0.33
602+00	644.04	644.03	0.32	644.47	644.52	0.39	644.89	644.86	0.29	644.45	644.45	0.33	644.01	643.95	0.27
602+50	644.01	644.07	0.38	644.46	644.54	0.41	644.90	644.88	0.30	644.50	644.50	0.33	644.10	644.10	0.33
603+00	643.99	644.07	0.41	644.44	644.49	0.38	644.90	644.86	0.29	644.51	644.54	0.35	644.13	644.16	0.36
603+50	643.96	643.96	0.33	644.41	644.47	0.39	644.86	644.86	0.33	644.42	644.48	0.38	643.98	644.04	0.39
604+00	644.13	644.05	0.24	644.47	644.51	0.36	644.81	644.79	0.31	644.32	644.35	0.36	643.83	643.77	0.27
604+50	644.31	644.31	0.33	644.52	644.44	0.25	644.73	644.69	0.29	644.21	644.18	0.31	643.68	643.63	0.28
605+00	644.04	643.97	0.26	644.33	644.22	0.22	644.63	644.56	0.26	644.08	644.07	0.32	643.53	643.54	0.34
605+50	643.76	643.68	0.24	644.14	644.07	0.27	644.51	644.36	0.18	643.95	643.93	0.31	643.39	643.36	0.30
606+00	643.49	643.40	0.23	643.93	643.92	0.32	644.37	644.25	0.21	643.81	643.79	0.31	643.24	643.22	0.31
606+50	643.22	643.12	0.23	643.72	643.74	0.35	644.22	644.19	0.30	643.66	643.65	0.32	643.10	643.04	0.27
607+00	642.95	642.84	0.22	643.51	643.59	0.41	644.08	644.00	0.25	643.51	643.51	0.33	642.95	642.93	0.31
607+50	642.81	642.60	0.13	643.37	643.37	0.34	643.93	643.84	0.24	643.37	643.34	0.30	642.80	642.62	0.15
608+00	642.66	642.49	0.16	643.22	643.21	0.32	643.78	643.70	0.25	643.22	643.16	0.27	642.66	642.41	0.08
608+50	642.51	642.36	0.17	643.08	643.11	0.36	643.64	643.57	0.26	643.08	643.00	0.25	642.51	642.31	0.13
609+00	642.37	642.26	0.22	642.93	642.96	0.36	643.49	643.39	0.23	642.93	642.83	0.23	642.37	642.15	0.11
609+50	642.22	642.08	0.18	642.79	642.83	0.37	643.35	643.27	0.25	642.79	642.76	0.31	642.22	641.99	0.10
610+00	642.08	641.92	0.17	642.64	642.65	0.33	643.20	643.18	0.30	642.64	642.62	0.30	642.08	641.90	0.15
610+50	641.94	641.83	0.22	642.50	642.56	0.39	643.06	643.03	0.29	642.50	642.51	0.33	641.94	641.79	0.18
611+00	641.80	641.64	0.16	642.37	642.40	0.37	642.93	642.89	0.29	642.37	642.30	0.27	641.80	641.65	0.18
611+50	641.67	641.56	0.21	642.24	642.28	0.37	642.80	642.75	0.28	642.24	642.20	0.29	641.67	641.45	0.10
612+00	641.55	641.40	0.19	642.11	642.11	0.33	642.67	642.60	0.26	642.11	642.10	0.32	641.55	641.41	0.20
612+50	641.43	641.25	0.15	641.99	641.99	0.33	642.55	642.48	0.26	641.99	641.98	0.32	641.43	641.33	0.24
613+00	641.31	641.07	0.10	641.87	641.88	0.34	642.43	642.37	0.26	641.87	641.84	0.30	641.31	641.17	0.19
613+50	641.19	641.03	0.17	641.76	641.76	0.34	642.32	642.28	0.29	641.76	641.72	0.30	641.19	641.05	0.19
614+00	641.09	640.96	0.20	641.65	641.65	0.34	642.21	642.15	0.27	641.65	641.64	0.32	641.09	640.82	0.07
614+50	640.98	640.92	0.27	641.54	641.55	0.34	642.11	642.04	0.26	641.54	641.55	0.34	640.98	640.86	0.21
615+00	640.88	640.77	0.22	641.44	641.44	0.32	642.01	641.98	0.31	641.44	641.41	0.30	640.88	640.65	0.10
615+50	640.78	640.76	0.31	641.35	641.40	0.38	641.91	641.87	0.29	641.35	641.32	0.31	640.78	640.54	0.09
616+00	640.69	640.65	0.29	641.26	641.29	0.37	641.82	641.79	0.30	641.26	641.25	0.32	640.69	640.68	0.32
616+50	640.61	640.60	0.33	641.17	641.21	0.37	641.73	641.72	0.32	641.17	641.21	0.38	640.61	640.71	0.43
617+00	640.52	640.40	0.21	641.08	641.14	0.39	641.65	641.62	0.30	641.08	641.08	0.33	640.52	640.55	0.36
617+50	640.44	640.36	0.25	641.01	641.03	0.36	641.57	641.52	0.28	641.01	640.94	0.27	640.44	640.35	0.23

NOTES:

- 1. MILL DEPTH SHOWN IS IN FEET.
- 2. NO ADDITIONAL PAYMENT FOR MILLING DEPTHS GREATER THAN THE PAY ITEM DESCRIPTION OF 3 TO 4 INCHES WILL BE MADE.

BITUMINOUS PAVEMENT MILLING (AR401650) - MILLING DEPTHS															
STATION	75' LEFT OF CENTERLINE			37.5' LEFT OF CENTERLINE			CENTERLINE			37.5' RIGHT OF CENTERLINE			75' RIGHT OF CENTERLINE		
	PROP. ELEV.	EXST. ELEV.	MILL DEPTH	PROP. ELEV.	EXST. ELEV.	MILL DEPTH	PROP. ELEV.	EXST. ELEV.	MILL DEPTH	PROP. ELEV.	EXST. ELEV.	MILL DEPTH	PROP. ELEV.	EXST. ELEV.	MILL DEPTH
618+00	640.37	640.24	0.20	640.93	640.95	0.35	641.49	641.40	0.24	640.93	640.86	0.26	640.37	640.24	0.20
618+50	640.30	640.15	0.18	640.86	640.87	0.34	641.42	641.40	0.31	640.86	640.88	0.35	640.30	640.27	0.30
619+00	640.23	640.14	0.23	640.79	640.82	0.36	641.36	641.35	0.33	640.79	640.79	0.33	640.23	640.20	0.29
619+50	640.17	640.03	0.19	640.73	640.76	0.36	641.30	641.26	0.29	640.73	640.70	0.30	640.17	640.11	0.27
620+00	640.11	640.03	0.25	640.68	640.71	0.37	641.24	641.20	0.29	640.68	640.67	0.32	640.11	640.05	0.26
620+50	640.06	640.00	0.27	640.62	640.65	0.36	641.19	641.11	0.26	640.62	640.60	0.31	640.06	639.94	0.21
621+00	640.01	639.86	0.18	640.57	640.58	0.34	641.14	641.10	0.29	640.57	640.56	0.32	640.01	639.90	0.22
621+50	639.97	639.81	0.17	640.53	640.54	0.34	641.09	641.03	0.27	640.53	640.49	0.29	639.97	639.88	0.24
622+00	639.93	639.78	0.18	640.49	640.50	0.34	641.05	641.01	0.29	640.49	640.49	0.34	639.93	639.74	0.14
622+50	639.89	639.78	0.22	640.45	640.48	0.36	641.02	640.95	0.26	640.45	640.44	0.32	639.89	639.57	0.01
623+00	639.86	639.78	0.25	640.42	640.44	0.35	640.98	640.94	0.29	640.42	640.40	0.31	639.86	639.73	0.20
623+50	639.83	639.72	0.21	640.40	640.39	0.32	640.96	640.92	0.29	640.40	640.35	0.29	639.83	639.69	0.19
624+00	639.81	639.70	0.22	640.37	640.36	0.32	640.93	640.86	0.25	640.37	640.31	0.27	639.81	639.69	0.21
624+50	639.79	639.65	0.19	640.35	640.33	0.31	640.92	640.80	0.22	640.35	640.29	0.27	639.79	639.67	0.21
625+00	639.78	639.63	0.18	640.34	640.32	0.31	640.90	640.83	0.26	640.34	640.28	0.27	639.78	639.67	0.23
625+50	639.77	639.68	0.24	640.33	640.31	0.32	640.89	640.82	0.25	640.33	640.25	0.25	639.77	639.69	0.26
626+00	639.76	639.61	0.18	640.32	640.32	0.33	640.89	640.83	0.27	640.32	640.24	0.24	639.76	639.65	0.22
626+50	639.76	639.64	0.21	640.32	640.30	0.30	640.89	640.80	0.25	640					

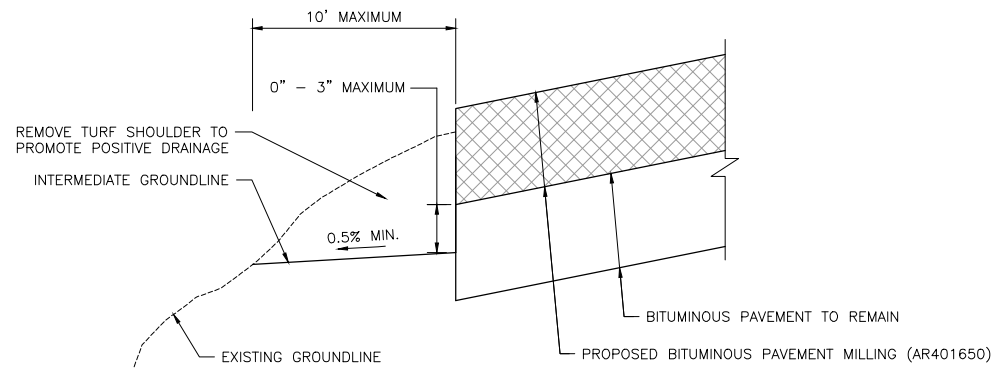

INTERMEDIATE SHOULDER DETAIL - AFTER MILLING

NOT TO SCALE

NOTES:

1. COSTS INCLUDED AS PART OF BITUMINOUS PAVEMENT MILLING (AR401650) AND SHOULDER ADJUSTMENT (AR152480).
2. TURF SHOULDER TO BE FLUSH TO 3" MAXIMUM BELOW EDGE OF PAVEMENT.

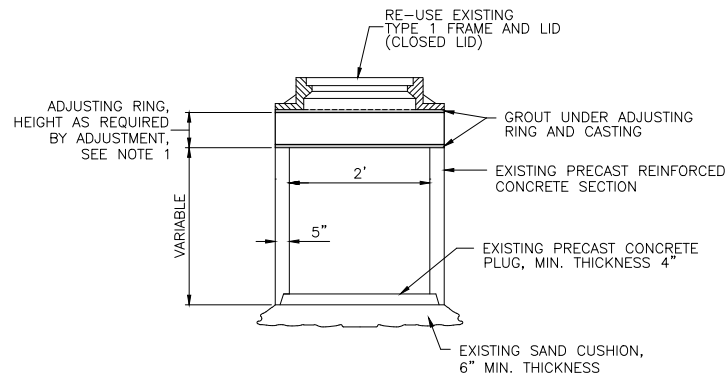

ADJUST UNDERDRAIN COLLECTION STRUCTURE

NOT TO SCALE

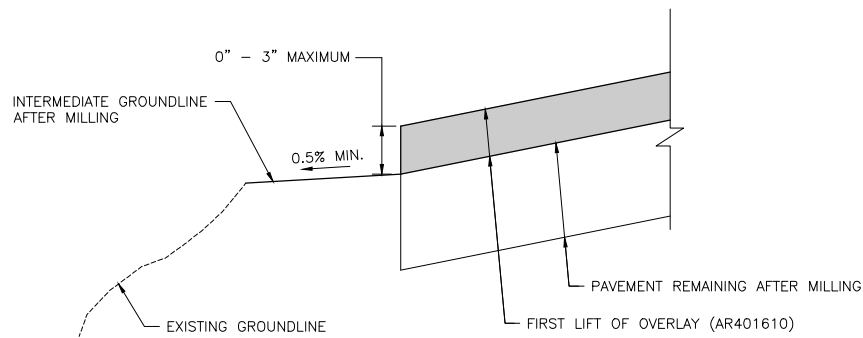

INTERMEDIATE SHOULDER DETAIL - AFTER FIRST LIFT

NOT TO SCALE

NOTES:

1. AFTER PAVING FIRST LIFT OF OVERLAY, ENSURE TURF SHOULDER IS 0" TO 3" MAXIMUM BELOW EDGE OF PAVEMENT.
2. COST OF INTERMEDIATE SHOULDER GRADING TO BE INCLUDED IN BITUMINOUS PAVEMENT MILLING (AR401650), SHOULDER ADJUSTMENT (AR152480) AND BITUMINOUS SURFACE COURSE (AR401610).
3. SEE TURF SHOULDER DETAIL ON TYPICAL SECTIONS, RUNWAY 16/34 SHEET FOR FINAL SHOULDER ADJUSTMENT

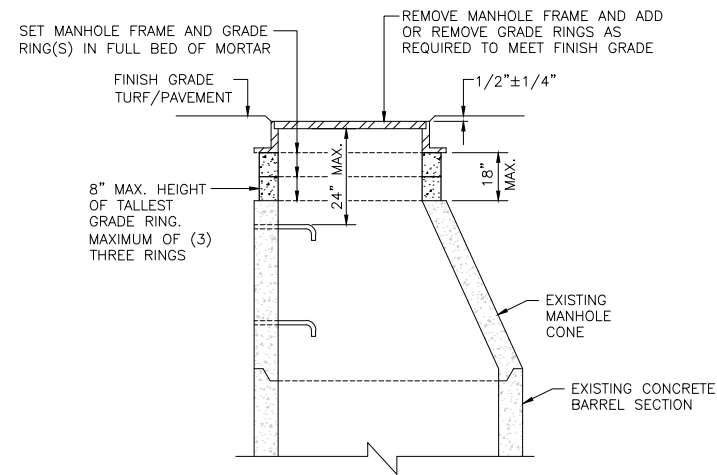

ADJUST MANHOLE (DRAINAGE OR ELECTRICAL)

NOT TO SCALE

STRUCTURE ADJUSTMENT NOTES:

1. CONTRACTOR SHALL BE RESPONSIBLE FOR FIELD CHECKING EXISTING MANHOLE CONFIGURATIONS AND SIZES FOR THE NECESSARY ADJUSTMENT.
2. THE MAXIMUM AMOUNT OF ADJUSTING RINGS ALLOWED SHALL BE THREE. STRUCTURES WITH THREE ADJUSTING RINGS ALREADY IN PLACE SHALL HAVE THE EXISTING RINGS REMOVED AND LARGER RINGS INSTALLED TO COMPLETE THE ADJUSTMENT. COSTS OF REMOVING AND DISPOSING OF EXISTING RINGS SHALL BE INCLUDED IN THE UNIT PRICE FOR THE ADJUSTMENT.
3. THE MAXIMUM HEIGHT OF ANY SINGLE ADJUSTING RING(S) SHALL BE 8 INCHES, INCLUDING EXISTING RINGS.
4. ADJUSTING RINGS SHALL BE PRE-CAST REINFORCED CONCRETE. ALL ADJUSTING RINGS AND METAL FRAME SHALL BE MORTARED INTO PLACE WITHOUT THE USE OF SHIMS OF ANY TYPE.
5. CONTRACTOR SHALL TAKE CARE TO PREVENT DIRT AND DEBRIS FROM ENTERING THE STRUCTURE. CONTRACTOR SHALL REMOVE ANY DIRT AND DEBRIS FOUND IN THE STRUCTURE PRIOR TO OR AFTER THE ADJUSTMENT, COSTS INCLUDED IN THE UNIT PRICE FOR THE ADJUSTMENT.
6. TOPSOIL PLACED AROUND STRUCTURES IN TURF SHALL BE THOROUGHLY COMPACTED TO PREVENT SETTLING.
7. AT THE CONTRACTOR'S OPTION AND AT NO ADDITIONAL COST TO THE CONTRACT, HEAVY DUTY IRON ADJUSTING RINGS MAY BE USED IN LIEU OF PRECAST ADJUSTING RINGS. ONLY ONE EXTENSION RING SHALL BE ALLOWED PER STRUCTURE.
8. EXISTING CASTINGS DAMAGED BY THE CONTRACTOR DURING REMOVAL OPERATIONS SHALL BE REPLACED AT NO ADDITIONAL COST TO THE CONTRACT.

IL. CONTRACT: **PA059**
 IL. LETTING ITEM: **18A**
 IL. PROJECT: **PWK-4414**
 S.B.G. PROJECT: **3-17-SBGP-XX**

SURVEY BOOK # 1302

REVISIONS

NUMBER	BY	DATE

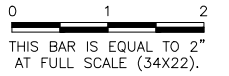

**CHICAGO EXECUTIVE AIRPORT
 WHEELING/PROSPECT HEIGHTS, ILLINOIS
 REHABILITATE RUNWAY 16/34**

SHOULDER AND STRUCTURE ADJUSTMENT DETAILS

© Copyright CMT, Inc.

CMT
 CRAWFORD, MURPHY & TILLY, INC.
 CONSULTING ENGINEERS
 License No. 184-000613

CHICAGO EXECUTIVE AIRPORT

DESIGN BY:	SMS
DRAWN BY:	JRO
CHECKED BY:	SMS
APPROVED BY:	DKP
DATE:	06/19/2015
JOB No:	14290-05-00

FINAL

DATE: Thursday, July 9, 2015, 13:10:08
 FILE: K:\Chicago\cdp\14290-05_RehabRW16-3A\Drawn Sheets\42_Proposed Pavement Marking_1.dwg
 UPDATE BY: Sean Smith
 LAYOUT: MARK_1
 KREF DWG: bchnt_runway.dwg
 IMAGE FILES: pwkrunway_logo_4-4-Color-Small
 CDR Alignments.dwg
 bpl(2)

GENERAL NOTES

1. ALL SURFACE PAINTED HOLDING POSITION SIGNS, RUNWAY HOLDING POSITION MARKINGS, AND ALL MARKINGS ON PCC PAVEMENT OR OLD ASPHALT (> 2 YEARS AGED) SHALL BE OUTLINED WITH A 6" BLACK BORDER.
2. TEMPORARY PAVEMENT MARKINGS ARE REQUIRED AFTER EACH LIFT OF SURFACE COURSE ON RUNWAY 16/34 UNLESS BOTH LIFTS ARE PLACED IN THE SAME CLOSURE PERIOD, IN WHICH CASE TEMPORARY MARKINGS ARE ONLY REQUIRED AFTER THE FINAL LIFT. BLACK BORDER IS NOT REQUIRED.
3. TEMPORARY MARKINGS SHALL ALSO BE REQUIRED AFTER THE ONLY LIFT OF SURFACE COURSE ON RUNWAYS 6/24 AND 12/30 AND ALL CONNECTING TAXIWAYS WITHIN THE WORK LIMITS. BLACK BORDER IS NOT REQUIRED.
4. PERMANENT MARKINGS SHALL BE PLACED ON ALL PAVEMENTS WITHIN THE WORK LIMITS DURING CLOSURES SCHEDULE FOR GROOVING RUNWAYS 12/30 AND 16/34.
5. WHERE EXISTING MARKINGS ARE TO BE PAINTED OVER, THE CONTRACTOR SHALL SCRAPE THE EXISTING MARKINGS TO REMOVE LOOSE PAINT PRIOR TO MARKING APPLICATION.

PAVEMENT MARKING NOTES

1. ALL TAXIWAY MARKINGS ARE REFLECTIVE YELLOW (AR620520). A 6" BLACK BORDER IS REQUIRED FOR MARKINGS PLACED OUTSIDE OF THE CONTRACT PAVING LIMITS ONLY (AR620520), UNLESS NOTED.
2. ALL RUNWAY MARKINGS (AR620520) ARE REFLECTIVE WHITE. BLACK BORDER SHALL NOT BE REQUIRED.
3. THE PAVEMENT SURFACE SHALL BE CLEAN AND DRY PRIOR TO MARKING.
4. WHEN YELLOW TAXIWAY STRIPING CROSSES ANY WHITE RUNWAY STRIPING, THE TAXIWAY STRIPE SHALL BE GAPPED 6" EACH SIDE OF RUNWAY STRIPE EXCEPT AT RUNWAY/RUNWAY HOLDLINES.
5. ALL LETTERS, NUMBERS AND SYMBOLS SHALL CONFORM TO FAA ADVISORY CIRCULAR 150/5340-1L (LATEST EDITION).

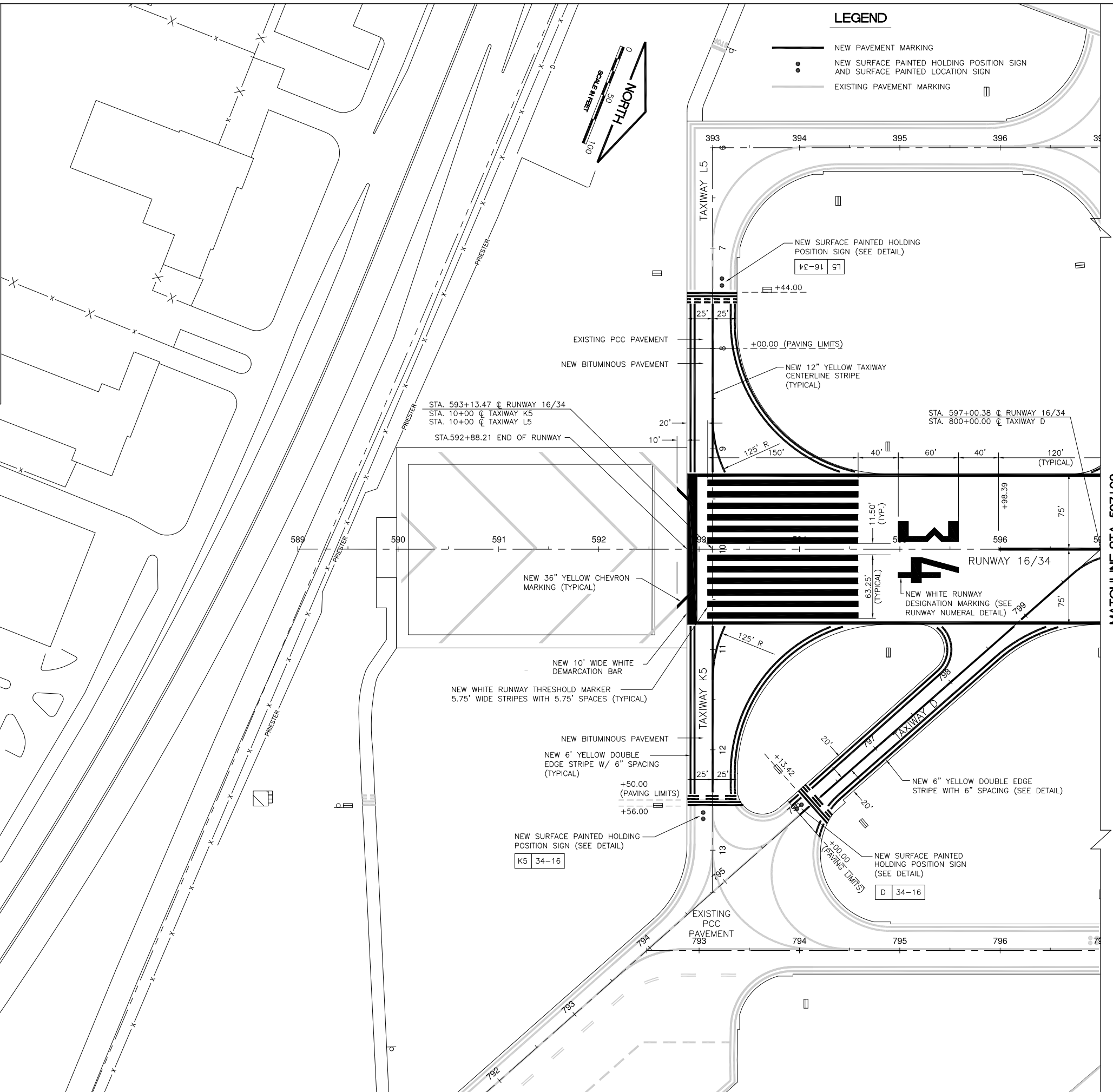
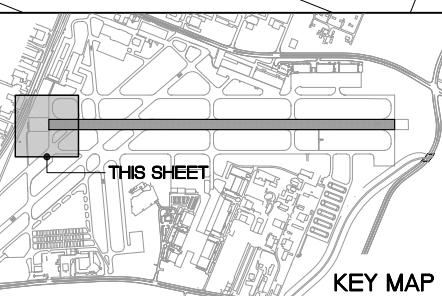

LEGEND

- NEW PAVEMENT MARKING
- NEW SURFACE PAINTED HOLDING POSITION SIGN AND SURFACE PAINTED LOCATION SIGN
- EXISTING PAVEMENT MARKING

IL CONTRACT: PA059
 IL LETTING ITEM: 18A
 IL PROJECT: PWK-4414
 S.B.G. PROJECT: 3-17-SBGP-XX

SURVEY BOOK # 1302

REVISIONS

NUMBER	BY	DATE

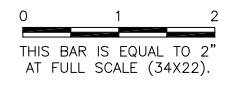

CHICAGO EXECUTIVE AIRPORT
WHEELING/PROSPECT HEIGHTS, ILLINOIS
REHABILITATE RUNWAY 16/34
PAVEMENT MARKING SHEET 1

CMT
 CRAWFORD, MURPHY & TILLY, INC.
 CONSULTING ENGINEERS
 License No. 184-000613

DESIGN BY:	RD
DRAWN BY:	JRO
CHECKED BY:	SMS
APPROVED BY:	DKP
DATE:	06/19/2015
JOB No:	14290-05-00

FINAL

DATE: Thursday, July 9, 2015, 09:46:00
 FILE: K:\Chicago\Recep\14290-05-Relab\RW16-34\Draw\Sheets\43-Proposed Pavement Marking 2.dwg
 UPDATE BY: Sean Smith
 LAYOUT: MARK 2
 IMAGE FILES: pwknewLOGO_CEA-4-Color-Small (2).jpg
 KREF DWG: bchrt1_runway.dwg
 C:\Users\sean.smith\Documents\14290-05-Relab\RW16-34\Draw\Alignments.dwg

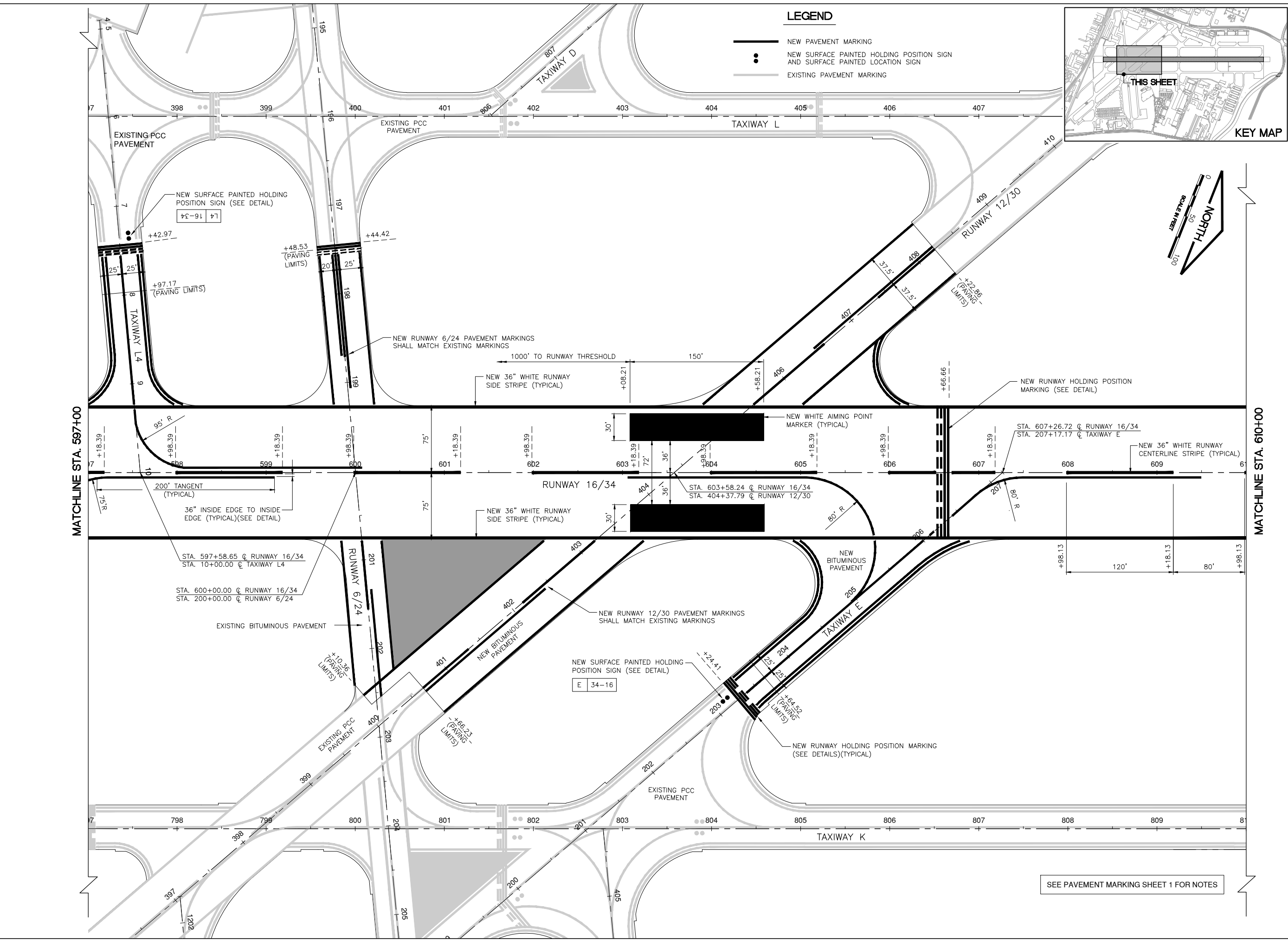

LEGEND

- NEW PAVEMENT MARKING
- NEW SURFACE PAINTED HOLDING POSITION SIGN AND SURFACE PAINTED LOCATION SIGN
- EXISTING PAVEMENT MARKING

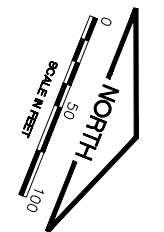
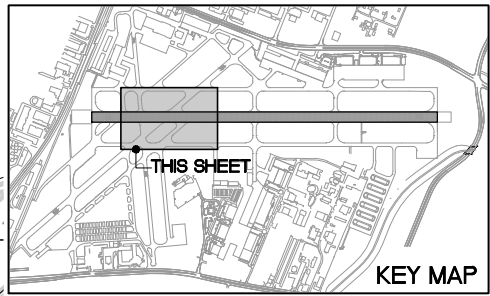

IL. CONTRACT: **PA059**
 IL. LETTING ITEM: **18A**
 IL. PROJECT: **PWK-4414**
 S.B.G. PROJECT: **3-17-SBGP-XX**

SURVEY BOOK # 1302

REVISIONS		
NUMBER	BY	DATE

**CHICAGO EXECUTIVE AIRPORT
 WHEELING/PROSPECT HEIGHTS, ILLINOIS
 REHABILITATE RUNWAY 16/34
 PAVEMENT MARKING SHEET 2**

© Copyright CMT, Inc.

CMT
 CRAWFORD, MURPHY & TILLY, INC.
 CONSULTING ENGINEERS
 License No. 184-000613

DESIGN BY:	RD
DRAWN BY:	JRO
CHECKED BY:	SMS
APPROVED BY:	DKP
DATE:	06/19/2015
JOB No:	14290-05-00

FINAL

SHEET 43 OF 58 SHEETS

SEE PAVEMENT MARKING SHEET 1 FOR NOTES

DATE: Thursday, July 9, 2015, 09:46:42
 FILE: K:\Chicago\Recep\14290-05_RehabRW16-34\Draw\Sheets\44_Proposed Pavement Marking_3.dwg
 UPDATE BY: Sean Smith
 LAYOUT: MARK_3
 KREF DWG: bchrlt_runway.dwg
 C:\Users\sean.smith\OneDrive\Documents\14290-05_RehabRW16-34\Draw\Sheets\44_Proposed Pavement Marking_3.dwg
 IMAGE FILES: pwknewLOGO_CEA-4-COLOR-SMALL (2).jpg

IL. CONTRACT: PA059
 IL. LETTING ITEM: 18A
 IL. PROJECT: PWK-4414
 S.B.G. PROJECT: 3-17-SBGP-XX

SURVEY BOOK # 1302

REVISIONS

NUMBER	BY	DATE

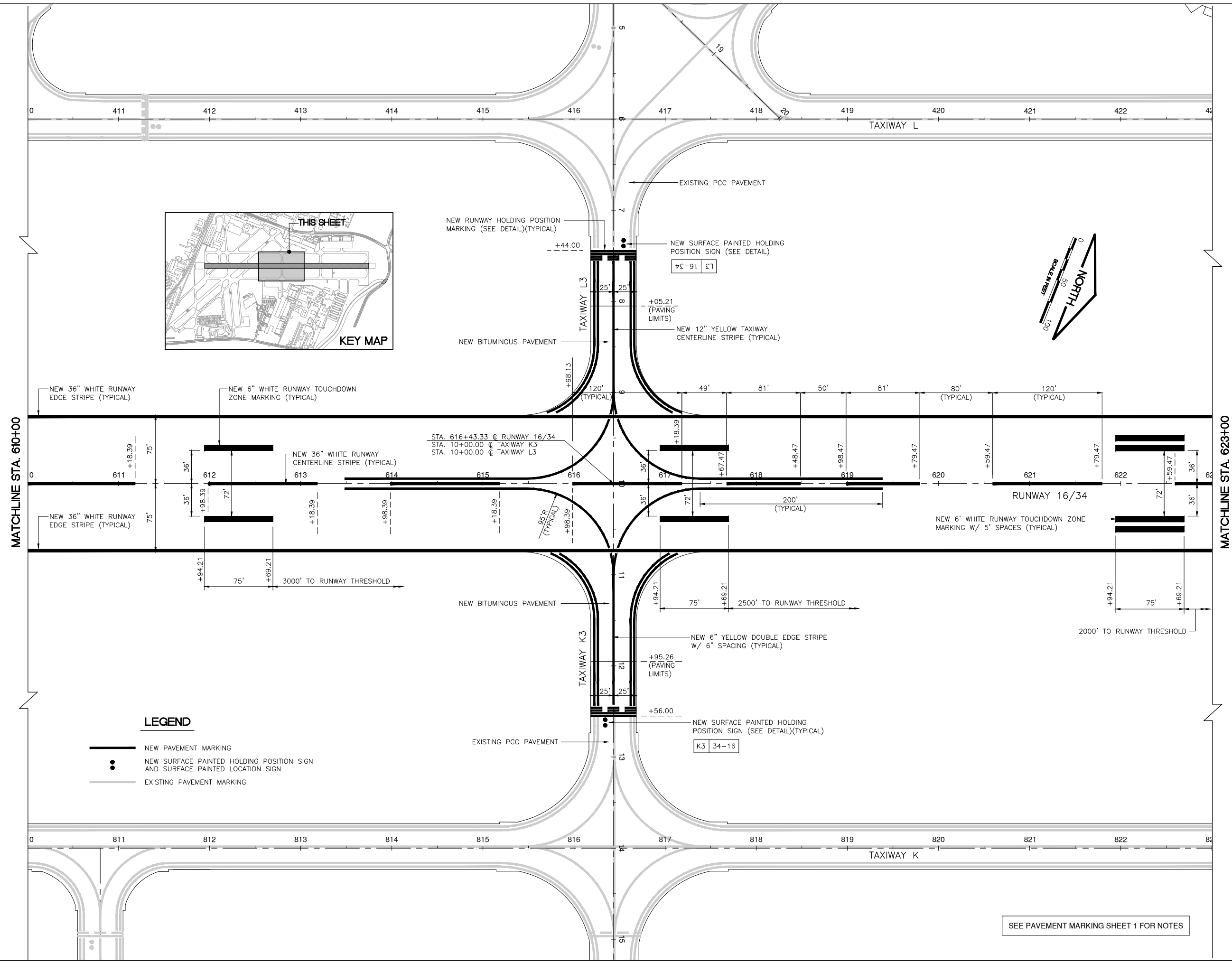
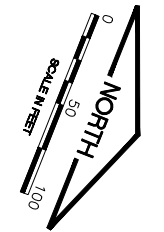
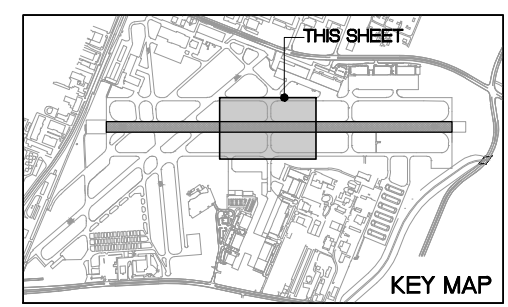
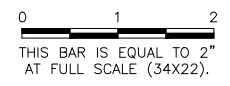

LEGEND

- NEW PAVEMENT MARKING
- NEW SURFACE PAINTED HOLDING POSITION SIGN AND SURFACE PAINTED LOCATION SIGN
- EXISTING PAVEMENT MARKING

SEE PAVEMENT MARKING SHEET 1 FOR NOTES

CHICAGO EXECUTIVE AIRPORT
 WHEELING/PROSPECT HEIGHTS, ILLINOIS
 REHABILITATE RUNWAY 16/34
 PAVEMENT MARKING SHEET 3

© Copyright CMT, Inc.

CRAWFORD, MURPHY & TILLY, INC.
 CONSULTING ENGINEERS
 License No. 184-000613

DESIGN BY:	RD
DRAWN BY:	JRO
CHECKED BY:	SMS
APPROVED BY:	DKP
DATE:	06/19/2015
JOB No:	14290-05-00

FINAL

KREF DWG: bchrt_runway.dwg
 C:\Users\jg34\OneDrive - NEW.dwg
 C:\Users\jg34\OneDrive - NEW.dwg

IMAGE FILES: pwknewLOGO_CEA-4-COLOR-Small (2).jpg

UPDATE BY: Sean Smith
 LAYOUT: MARK 4

DATE: Thursday, July 9, 2015, 09:47:23
 FILE: K:\Chicago\Recep\14290-05_RehabRW16-34\Draw\Sheets\45_Proposed Pavement Marking 4.dwg

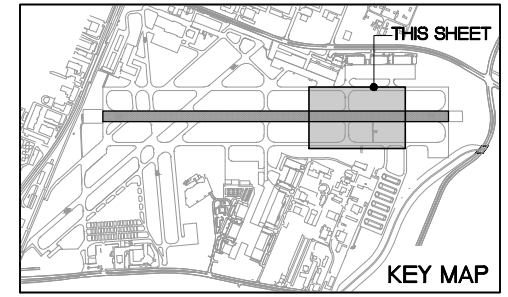
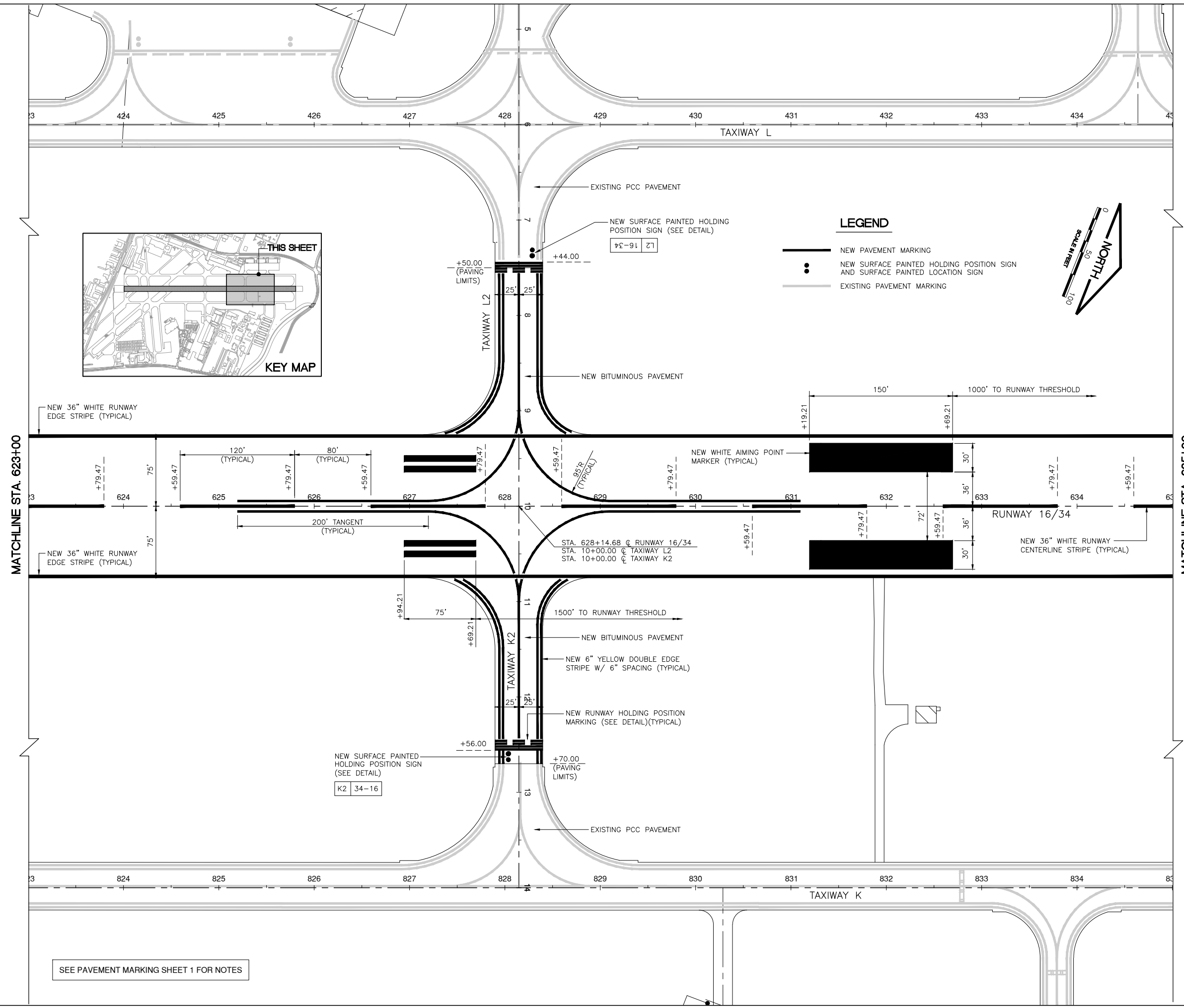

LEGEND

- NEW PAVEMENT MARKING
- NEW SURFACE PAINTED HOLDING POSITION SIGN AND SURFACE PAINTED LOCATION SIGN
- EXISTING PAVEMENT MARKING

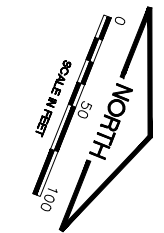

IL. CONTRACT: **PA059**
 IL. LETTING ITEM: **18A**
 IL. PROJECT: **PWK-4414**
 S.B.G. PROJECT: **3-17-SBGP-XX**

SURVEY BOOK # 1302

REVISIONS		
NUMBER	BY	DATE

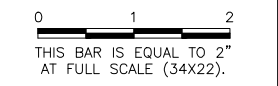

**CHICAGO EXECUTIVE AIRPORT
 WHEELING/PROSPECT HEIGHTS, ILLINOIS
 REHABILITATE RUNWAY 16/34
 PAVEMENT MARKING SHEET 4**

© Copyright CMT, Inc.

CMT
 CRAWFORD, MURPHY & TILLY, INC.
 CONSULTING ENGINEERS
 License No. 184-000613

DESIGN BY:	RD
DRAWN BY:	JRO
CHECKED BY:	SMS
APPROVED BY:	DKP
DATE:	06/19/2015
JOB No:	14290-05-00

FINAL

SEE PAVEMENT MARKING SHEET 1 FOR NOTES

DATE: Thursday, July 9, 2015, 13:09:22
 FILE: K:\Chicago\cdop\14290-05_RehabRW16-3A\Draw\Sheets\46_Proposed Pavement Marking 5.dwg
 UPDATE BY: Sean Smith
 LAYOUT: MARK 5
 KREF DWG: bchnt_runway.dwg
 CREF DWG: cfmw_runway.dwg
 CDR Alignments.dwg
 IMAGE FILES: pwkrunwaylogo_cea-4-Color-Small (2).jpg

I.L. CONTRACT: **PA059**
 I.L. LETTING ITEM: **18A**
 I.L. PROJECT: **PWK-4414**
 S.B.G. PROJECT: **3-17-SBGP-XX**

SURVEY BOOK # 1302

REVISIONS		
NUMBER	BY	DATE

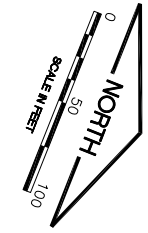
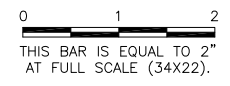

LEGEND

- NEW PAVEMENT MARKING
- NEW SURFACE PAINTED HOLDING POSITION SIGN AND SURFACE PAINTED LOCATION SIGN
- EXISTING PAVEMENT MARKING

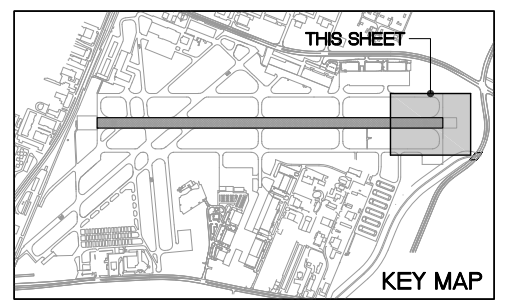
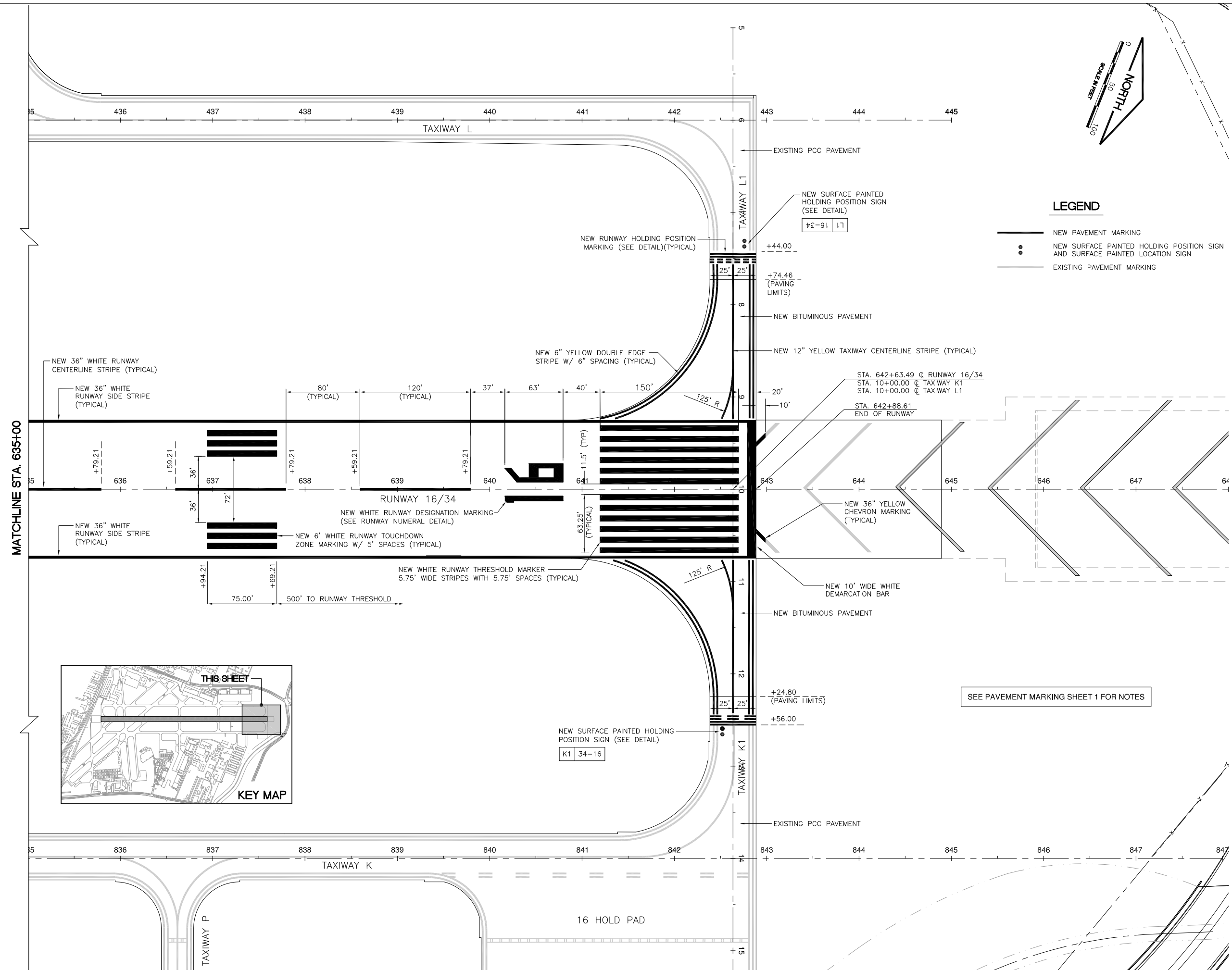

SEE PAVEMENT MARKING SHEET 1 FOR NOTES

CHICAGO EXECUTIVE AIRPORT
WHEELING/PROSPECT HEIGHTS, ILLINOIS
REHABILITATE RUNWAY 16/34
PAVEMENT MARKING SHEET 5

© Copyright CMT, Inc.
CMT
 CRAWFORD, MURPHY & TILLY, INC.
 CONSULTING ENGINEERS
 License No. 184-000613



DESIGN BY:	RD
DRAWN BY:	JRO
CHECKED BY:	SMS
APPROVED BY:	DKP
DATE:	06/19/2015
JOB No:	14290-05-00

FINAL

DATE: Thursday, July 9, 2015 09:48:30
 FILE: K:\Chicago\Recon\14290-05_Rehab\16-34\Draw\Sheets\47 PVT MARK DETS.dwg
 UPDATE BY: Sean Smith
 LAYOUT: PVT MARK DETS
 REF DWG: bchml_rumwyoj.dwg
 IMAGE FILES: pwrknewLOGO_CEA-4-Color-Small (2).jpg

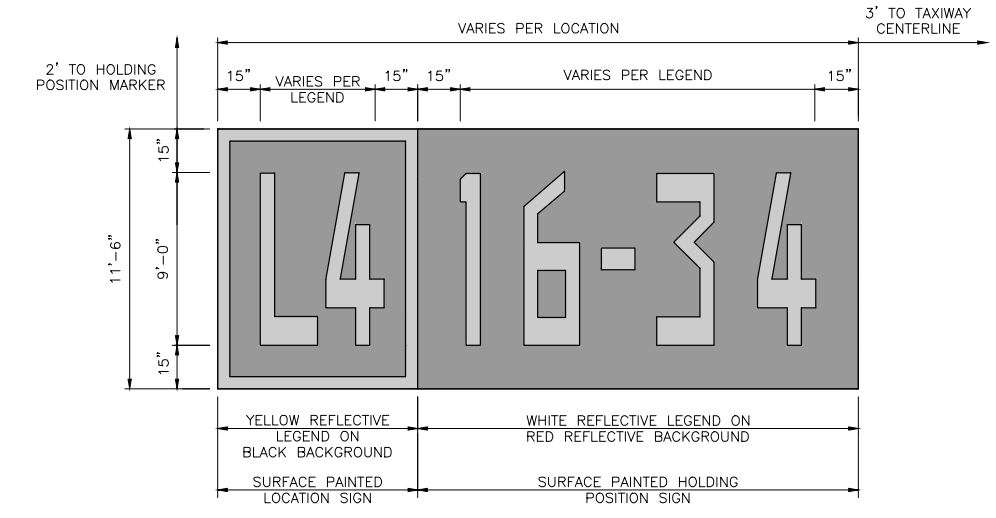
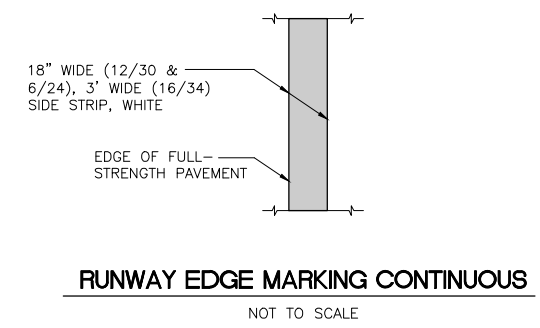
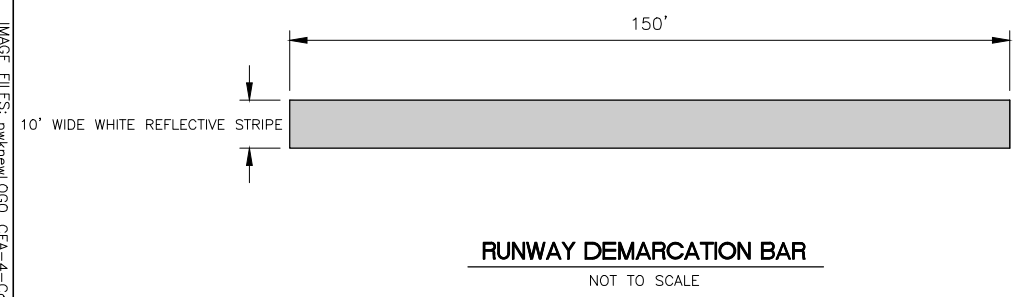
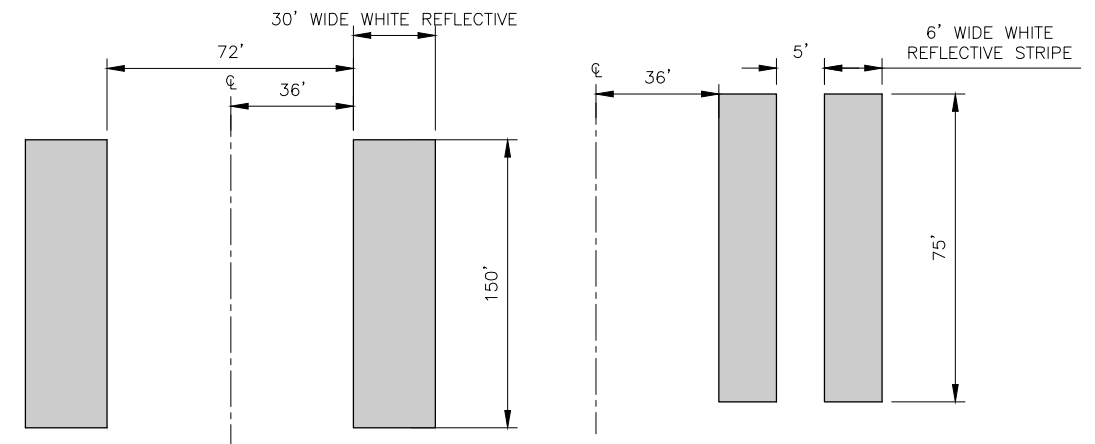
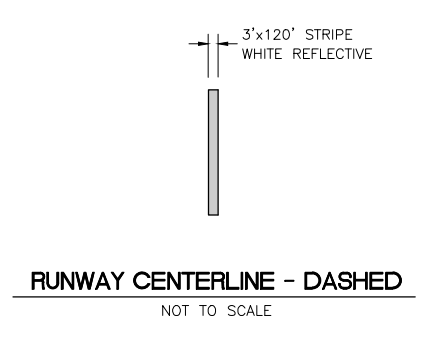

1. ALL SURFACE PAINTED HOLDING POSITION SIGNS SHALL HAVE A RED REFLECTIVE BACKGROUND WITH A WHITE REFLECTIVE INSCRIPTION.
2. ALL SURFACE PAINTED LOCATION SIGNS SHALL HAVE A BLACK NON-REFLECTIVE BACKGROUND WITH A REFLECTIVE YELLOW INSCRIPTION. THE YELLOW OUTLINE SHALL BE REFLECTIVE.
3. ALL SURFACE PAINTED SIGNS SHALL BE OUTLINED WITH A 6" BLACK BORDER.
4. LEGENDS SHALL BE AS SHOWN ON THE PLANS OR AS DIRECTED BY THE AIRPORT MANAGER.
5. ALL LETTERS, NUMBERS AND SYMBOLS SHALL CONFORM TO FAA ADVISORY CIRCULAR 150/5340-1(LATEST EDITION).

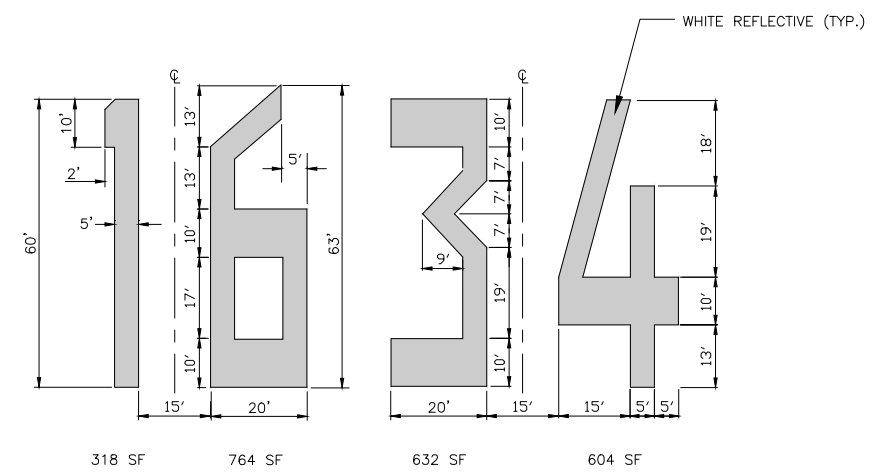
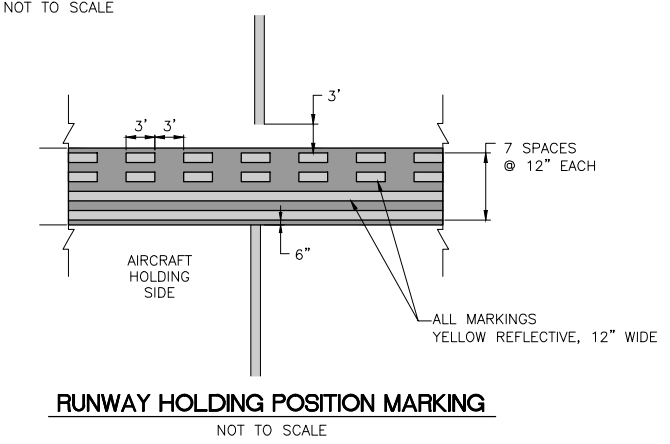
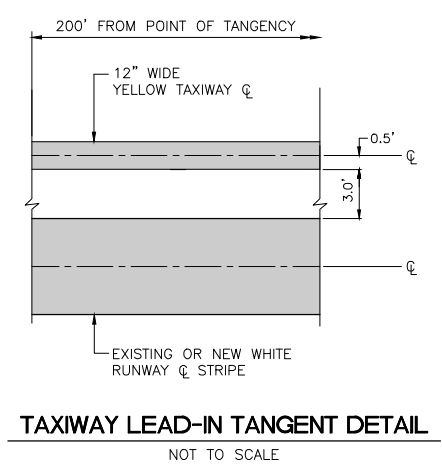

IL. CONTRACT: **PA059**
 IL. LETTING ITEM: **18A**
 IL. PROJECT: **PWK-4414**
 S.B.G. PROJECT: **3-17-SBGP-XX**

SURVEY BOOK # 1302

REVISIONS		
NUMBER	BY	DATE

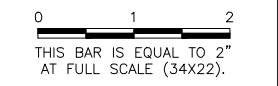

**CHICAGO EXECUTIVE AIRPORT
 WHEELING/PROSPECT HEIGHTS, ILLINOIS
 REHABILITATE RUNWAY 16/34**
PAVEMENT MARKING DETAILS











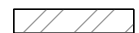





© Copyright CMT, Inc.
CMT
 CRAWFORD, MURPHY & TILLY, INC.
 CONSULTING ENGINEERS
 License No. 184-000613

DESIGN BY:	RD
DRAWN BY:	JRO
CHECKED BY:	SMS
APPROVED BY:	DKP
DATE:	06/19/2015
JOB No:	14290-05-00

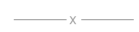
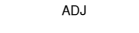
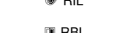
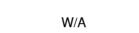
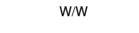
FINAL

SHEET 47 OF 58 SHEETS

LEGEND

-  NEW 3'-4" BITUMINOUS PAVEMENT MILLING AND 4" BITUMINOUS OVERLAY
-  NEW BUTT JOINT CONSTRUCTION AND 2" BITUMINOUS OVERLAY
-  EXISTING STORM SEWER
-  EXISTING INLET/MANHOLE
-  EXISTING SLOPE BOX
-  EXISTING ELECTRICAL MANHOLE/HANDHOLE
-  EXISTING ELECTRICAL DUCT
-  EXISTING BASE MOUNTED RUNWAY LIGHT
-  EXISTING BASE MOUNTED TAXIWAY LIGHT
-  EXISTING IN-PAVEMENT RUNWAY LIGHT
-  EXISTING TAXI GUIDANCE SIGN
-  EXISTING UNDERDRAIN
-  EXISTING WATERMAIN
-  EXISTING SANITARY SEWER
-  EXISTING PERIMETER FENCE
-  ITEM TO BE ADJUSTED (BASE BID)
-  REPLACE HIGH INTENSITY IN-PAVEMENT RUNWAY EDGE LIGHT (BASE BID)
-  REPLACE HIGH INTENSITY BASE MOUNTED RUNWAY EDGE LIGHT (ADDITIVE ALTERNATE 1)
-  WHITE LENSE / AMBER LENSE
-  WHITE LENSE / WHITE LENSE
-  SPLICE CAN

KEYED NOTES

- ① CORE NEW OPENING IN EXISTING LIGHT OR SIGN BASE
- ② DISCONNECT EXISTING CONDUIT, CONNECT NEW CONDUIT
- ③ CORE OPENING IN EXISTING HANDHOLE/MANHOLE
- ④ EXISTING DUCT TO BE ABANDONED
- ⑤ DISCONNECT CABLE TO SIGN, COMPLETE CIRCUIT AT LIGHT
- ⑥ LOCATE EXISTING CONDUIT, CONNECT TO NEW CONDUIT
- ⑦ NEW 2" PVC DUCT, DIRECT BURY WITH 1/C #8 5KV UG CABLE (RUNWAY 16/34 CIRCUIT)
- ⑧ NEW 2" PVC DUCT, DIRECT BURY WITH 2-1/C #8 5KV UG CABLE (RUNWAY 16/34 CIRCUIT)
- ⑨ NEW 2" PVC DUCT, DIRECT BURY WITH 1/C #8 5KV UG CABLE (TAXIWAY CIRCUIT)
- ⑩ NEW 1/C #8 5KV UG CABLE IN EXISTING DUCT
- ⑪ NEW 2-1/C #8 5KV UG CABLE IN EXISTING DUCT
- ⑫ NEW 2" PVC DUCT, DIRECT BURY WITH 2-1/C #8 5 KV UG CABLE (TAXIWAY CIRCUIT)
- ⑬ NEW 2" PVC DUCT, DIRECT BURY WITH 2-1/C #8 5 KV UG CABLE (RUNWAY 12/30 CIRCUIT)
- ⑭ NEW 2" PVC DUCT, DIRECT BURY WITH 2-1/C #8 5 KV UG CABLE (RUNWAY 6/24 CIRCUIT)

GENERAL NOTES

1. IT IS THE CONTRACTOR'S RESPONSIBILITY TO FIELD VERIFY THE LOCATION OF EXISTING UTILITIES. ANY DAMAGE TO EXISTING UTILITIES SHALL BE REPAIRED IMMEDIATELY AT THE CONTRACTOR'S EXPENSE. THE CONTRACTOR SHALL VERIFY EXISTING CIRCUIT ROUTING PRIOR TO MAKING ANY FIELD MODIFICATIONS.
2. CONTRACTOR SHALL EXERCISE EXTREME CARE WHEN MILLING NEAR IN-PAVEMENT LIGHT CANS TO AVOID DAMAGE TO LIGHT CANS TO REMAIN. DAMAGED LIGHT CANS SHALL BE REPLACED AT THE CONTRACTOR'S EXPENSE TO THE SATISFACTION OF THE ENGINEER.
3. THE ELECTRICAL IMPROVEMENTS SHEETS CONTAIN WORK TO BE COMPLETED UNDER BOTH THE BASE BID AND ADDITIVE ALTERNATE 1:
 - BASE BID:**
 - ADJUST ELECTRICAL MANHOLES
 - REPLACE IN-PAVEMENT HIGH INTENSITY RUNWAY EDGE LIGHTS (QUARTZ)
 - MODIFY EXISTING SIGN PANEL
 - REMOVE AND REPLACE LAHSO LIGHT INSTALLATION (AR800131 AND AR800132)
 - ADDITIVE ALTERNATE 1:**
 - REPLACE BASE MOUNTED HIGH INTENSITY RUNWAY EDGE LIGHTS (QUARTZ)
 - INSTALL SPLICE CANS
 - INSTALL NEW 2" PVC CONDUIT, DIRECT BURY
 - INSTALL NEW 1/C AND 2/C #8 5 KV UG CABLE IN NEW AND EXISTING DUCT
 - VAULT MODIFICATIONS, INCLUDING INSTALLATION OF A NEW 30 KW REGULATOR, STYLE 2
4. REMOVE EXISTING CABLE TO MAKE WAY FOR NEW CABLE IN EXISTING DUCT. CABLE SHALL BE DISPOSED OF OFF AIRPORT PROPERTY. CABLE IN DUCT TO BE ABANDONED SHALL ALSO BE REMOVED AND DISPOSED OF OFFSITE. REMOVAL AND DISPOSAL COSTS SHALL BE CONSIDERED INCLUDED IN THE COSTS FOR THE NEW CABLE.
5. CONNECTING NEW CONDUIT TO EXISTING LIGHT AND SIGN BASES SHALL BE CONSIDERED INCIDENTAL TO CONDUIT INSTALLATION.
6. REMOVING EXISTING CONDUIT FROM EXISTING LIGHT AND SIGN BASES IN ORDER TO CONNECT NEW CONDUIT SHALL BE CONSIDERED INCIDENTAL TO CONDUIT INSTALLATION. CONDUIT REMOVED SHALL BE DISPOSED OF OFF AIRPORT PROPERTY.
7. CORING EXISTING MANHOLES, HANDHOLES AND LIGHT AND SIGN CANS IN ORDER TO CONNECT NEW CONDUIT SHALL BE CONSIDERED INCIDENTAL TO THE CONDUIT INSTALLATION.
8. SEE HOMERUN PLAN FOR CABLE ROUTING TO AIRFIELD ELECTRICAL VAULT.
9. PRIOR TO INSTALLATION OF NEW CONDUIT AND CABLE, THE CONTRACTOR SHALL VERIFY THE ROUTING OF THE EXISTING AND PROPOSED CIRCUIT TO ENSURE A CONTINUOUS LOOP WILL BE ACHIEVED, COSTS INCIDENTAL TO THE CONDUIT AND CABLE INSTALLATION.

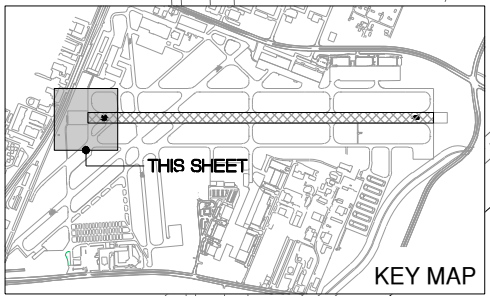
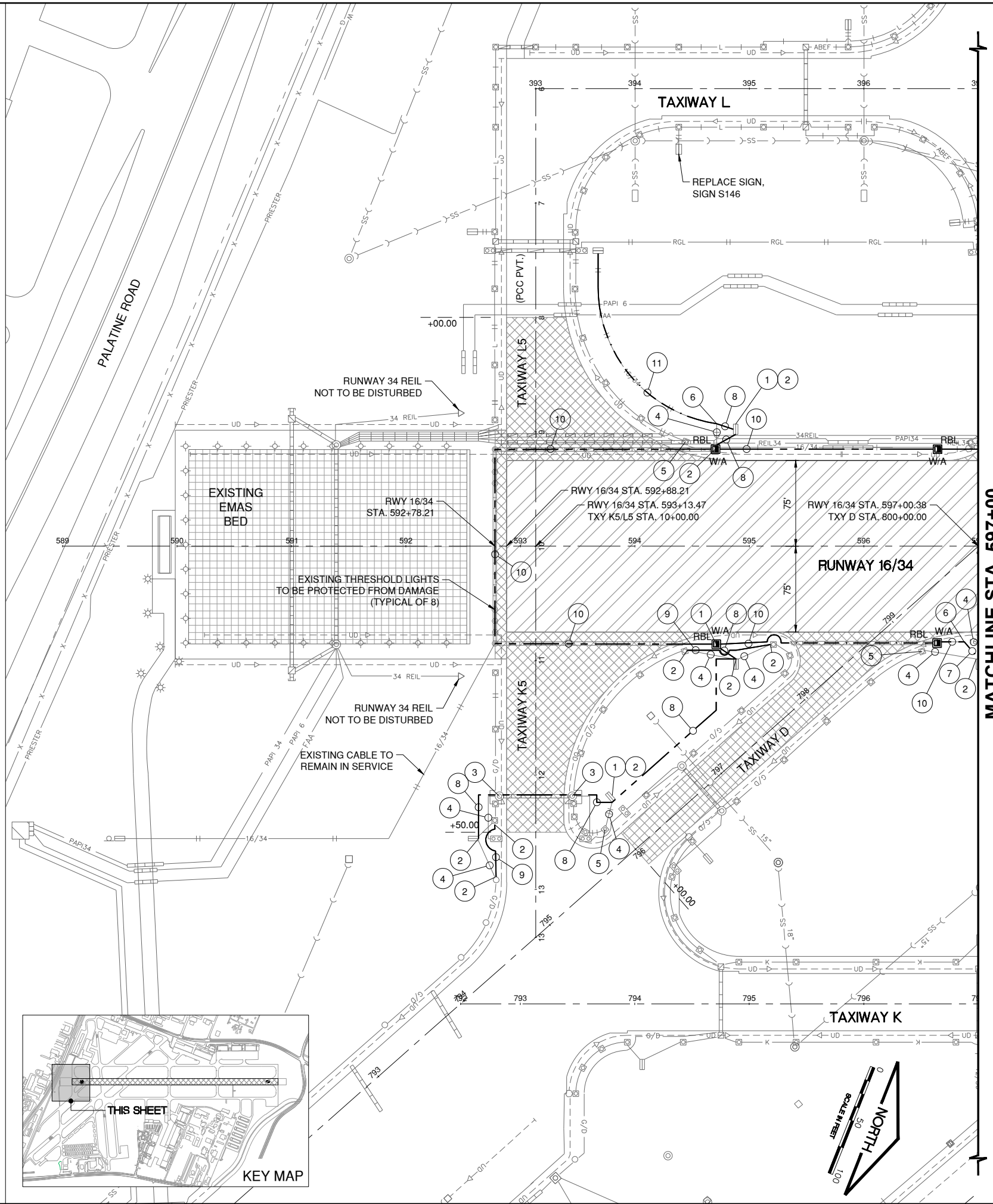

MATCHLINE STA. 597+00

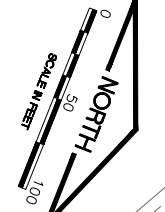

IL. CONTRACT: **PA059**
 IL. LETTING ITEM: **18A**
 IL. PROJECT: **PWK-4414**
 S.B.G. PROJECT: **3-17-SBGP-XX**

SURVEY BOOK # 1302

REVISIONS		
NUMBER	BY	DATE

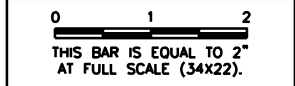

**CHICAGO EXECUTIVE AIRPORT
 WHEELING/PROSPECT HEIGHTS, ILLINOIS
 REHABILITATE RUNWAY 16/34**

ELECTRICAL IMPROVEMENTS SHEET 1

© Copyright CMT, Inc.

CMT
 CRAWFORD, MURPHY & TILLY, INC.
 CONSULTING ENGINEERS
 License No. 184-000613

CHICAGO EXECUTIVE AIRPORT

DESIGN BY:	SMS
DRAWN BY:	JRO
CHECKED BY:	SMS
APPROVED BY:	DKP
DATE:	06/19/2015
JOB No:	14290-05-00

FINAL

SHEET 48 OF 58 SHEETS

DATE: Thursday, July 9, 2015 09:49:17
 FILE: K:\Chicago\ref\14290-05_Rehab\16-34\Draw\Sheets\48-52 ELEC IMP.dwg
 UPDATE BY: Sean Smith
 LAYOUT: ELEC 2
 REF DWG: runway_16-34_base-NEW.dwg
 IMAGE FILES: pwknewLOGO_CEA-4_Color-Small (2).jpg
 BENCH: runway.dwg
 runway_16-34_electrical_base.dwg

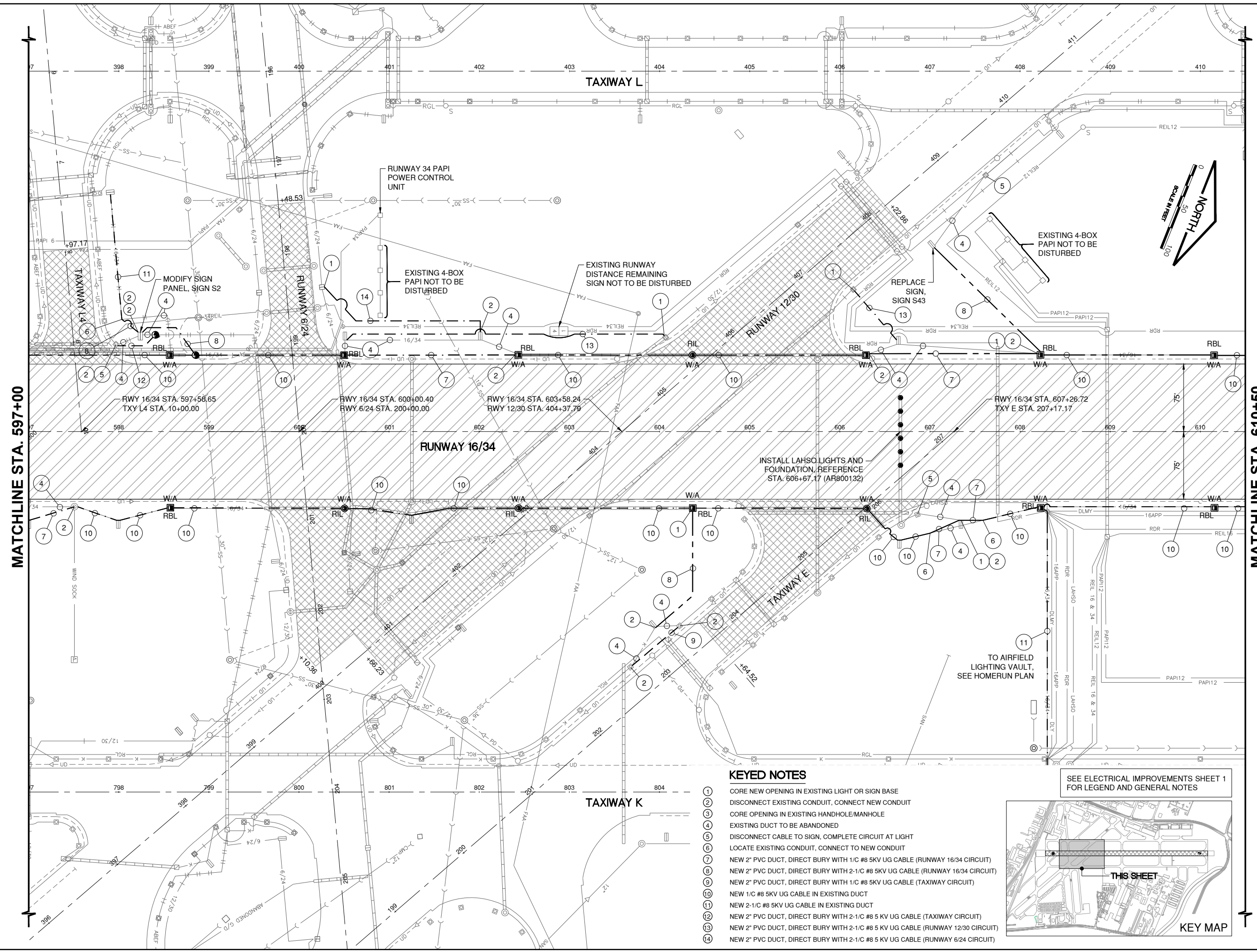

MATCHLINE STA. 597+00

MATCHLINE STA. 610+50

IL CONTRACT: PA059
 IL LETTING ITEM: 18A
 IL PROJECT: PWK-4414
 S.B.G. PROJECT: 3-17-SBGP-XX

SURVEY BOOK # 1302

REVISIONS		
NUMBER	BY	DATE

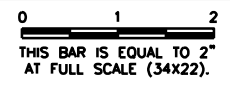

CHICAGO EXECUTIVE AIRPORT
 WHEELING/PROSPECT HEIGHTS, ILLINOIS
 REHABILITATE RUNWAY 16/34

ELECTRICAL IMPROVEMENTS SHEET 2

- KEYED NOTES**
- ① CORE NEW OPENING IN EXISTING LIGHT OR SIGN BASE
 - ② DISCONNECT EXISTING CONDUIT, CONNECT NEW CONDUIT
 - ③ CORE OPENING IN EXISTING HANDHOLE/MANHOLE
 - ④ EXISTING DUCT TO BE ABANDONED
 - ⑤ DISCONNECT CABLE TO SIGN, COMPLETE CIRCUIT AT LIGHT
 - ⑥ LOCATE EXISTING CONDUIT, CONNECT TO NEW CONDUIT
 - ⑦ NEW 2" PVC DUCT, DIRECT BURY WITH 1/C #8 5KV UG CABLE (RUNWAY 16/34 CIRCUIT)
 - ⑧ NEW 2" PVC DUCT, DIRECT BURY WITH 2-1/C #8 5KV UG CABLE (RUNWAY 16/34 CIRCUIT)
 - ⑨ NEW 2" PVC DUCT, DIRECT BURY WITH 1/C #8 5KV UG CABLE (TAXIWAY CIRCUIT)
 - ⑩ NEW 1/C #8 5KV UG CABLE IN EXISTING DUCT
 - ⑪ NEW 2-1/C #8 5KV UG CABLE IN EXISTING DUCT
 - ⑫ NEW 2" PVC DUCT, DIRECT BURY WITH 2-1/C #8 5 KV UG CABLE (TAXIWAY CIRCUIT)
 - ⑬ NEW 2" PVC DUCT, DIRECT BURY WITH 2-1/C #8 5 KV UG CABLE (RUNWAY 12/30 CIRCUIT)
 - ⑭ NEW 2" PVC DUCT, DIRECT BURY WITH 2-1/C #8 5 KV UG CABLE (RUNWAY 6/24 CIRCUIT)

SEE ELECTRICAL IMPROVEMENTS SHEET 1 FOR LEGEND AND GENERAL NOTES

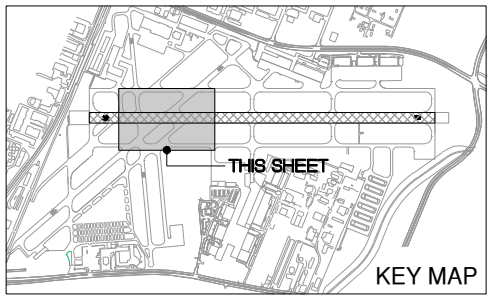

© Copyright CMT, Inc.

CMT
 CRAWFORD, MURPHY & TILLY, INC.
 CONSULTING ENGINEERS
 License No. 184-000613

CHICAGO EXECUTIVE AIRPORT

DESIGN BY:	SMS
DRAWN BY:	JRO
CHECKED BY:	SMS
APPROVED BY:	DKP
DATE:	06/19/2015
JOB No:	14290-05-00

FINAL

SHEET 49 OF 58 SHEETS

DATE: Thursday, July 9, 2015, 09:49:25
 FILE: K:\Chicago\Tech\14290-05_RehabRWY16-34\Draw\Sheets\48-52_ELEC_IMP.dwg
 REF: DWG: runway_16-34_base-NEW.dwg
 Tbl:\tbl_runway.dwg
 runway_16-34_electrical_base.dwg
 UPDATE BY: Sean Smith
 LAYOUT: ELEC_3
 IMAGE FILES: pwknewLOGO_CEA-4_Color-Small (2).jpg

IL CONTRACT: PA059
 IL LETTING ITEM: 18A
 IL PROJECT: PWK-4414
 S.B.G. PROJECT: 3-17-SBGP-XX

SURVEY BOOK # 1302

REVISIONS		
NUMBER	BY	DATE

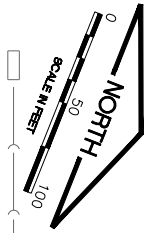
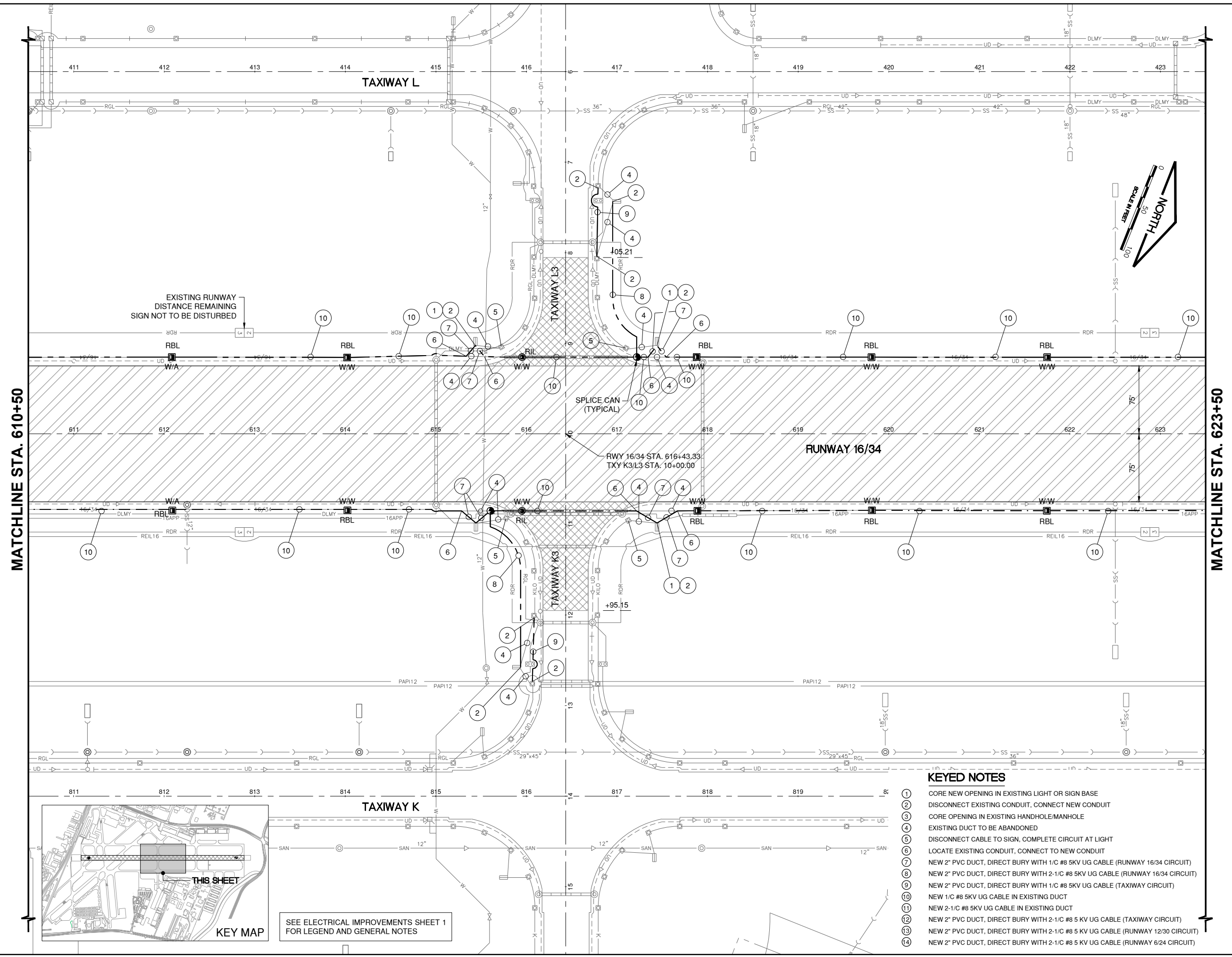
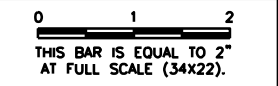

CHICAGO EXECUTIVE AIRPORT
 WHEELING/PROSPECT HEIGHTS, ILLINOIS
 REHABILITATE RUNWAY 16/34
 ELECTRICAL IMPROVEMENTS SHEET 3

© Copyright CMT, Inc.
CMT
 CRAWFORD, MURPHY & TILLY, INC.
 CONSULTING ENGINEERS
 License No. 184-000613
CHICAGO EXECUTIVE AIRPORT

DESIGN BY:	SMS
DRAWN BY:	JRO
CHECKED BY:	SMS
APPROVED BY:	DKP
DATE:	06/19/2015
JOB No:	14290-05-00

FINAL
 SHEET 50 OF 58 SHEETS

- KEYED NOTES**
- ① CORE NEW OPENING IN EXISTING LIGHT OR SIGN BASE
 - ② DISCONNECT EXISTING CONDUIT, CONNECT NEW CONDUIT
 - ③ CORE OPENING IN EXISTING HANDHOLE/MANHOLE
 - ④ EXISTING DUCT TO BE ABANDONED
 - ⑤ DISCONNECT CABLE TO SIGN, COMPLETE CIRCUIT AT LIGHT
 - ⑥ LOCATE EXISTING CONDUIT, CONNECT TO NEW CONDUIT
 - ⑦ NEW 2" PVC DUCT, DIRECT BURY WITH 1/1" #8 5KV UG CABLE (RUNWAY 16/34 CIRCUIT)
 - ⑧ NEW 2" PVC DUCT, DIRECT BURY WITH 2-1/1" #8 5KV UG CABLE (RUNWAY 16/34 CIRCUIT)
 - ⑨ NEW 2" PVC DUCT, DIRECT BURY WITH 1/1" #8 5KV UG CABLE (TAXIWAY CIRCUIT)
 - ⑩ NEW 1/1" #8 5KV UG CABLE IN EXISTING DUCT
 - ⑪ NEW 2-1/1" #8 5KV UG CABLE IN EXISTING DUCT
 - ⑫ NEW 2" PVC DUCT, DIRECT BURY WITH 2-1/1" #8 5KV UG CABLE (TAXIWAY CIRCUIT)
 - ⑬ NEW 2" PVC DUCT, DIRECT BURY WITH 2-1/1" #8 5KV UG CABLE (RUNWAY 12/30 CIRCUIT)
 - ⑭ NEW 2" PVC DUCT, DIRECT BURY WITH 2-1/1" #8 5KV UG CABLE (RUNWAY 6/24 CIRCUIT)

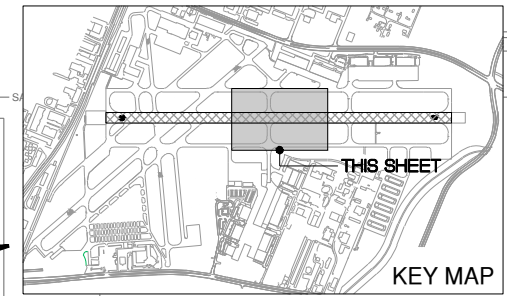

SEE ELECTRICAL IMPROVEMENTS SHEET 1 FOR LEGEND AND GENERAL NOTES

DATE: Thursday, July 9, 2015, 09:49:35
 FILE: K:\Chicago\14290-05_Rehab\16-34\Draw\Sheets\48-52_ELEC_IMP.dwg
 REF: DWG: runway_16-34_base-NEW.dwg
 UPDATE BY: Sean Smith
 LAYOUT: ELEC 4
 IMAGE FILES: pwknewLOGO_CEA-4_Color-Small (2).jpg
 REF: DWG: runway_16-34_base-NEW.dwg
 FILE: K:\Chicago\14290-05_Rehab\16-34\Draw\Sheets\48-52_ELEC_IMP.dwg

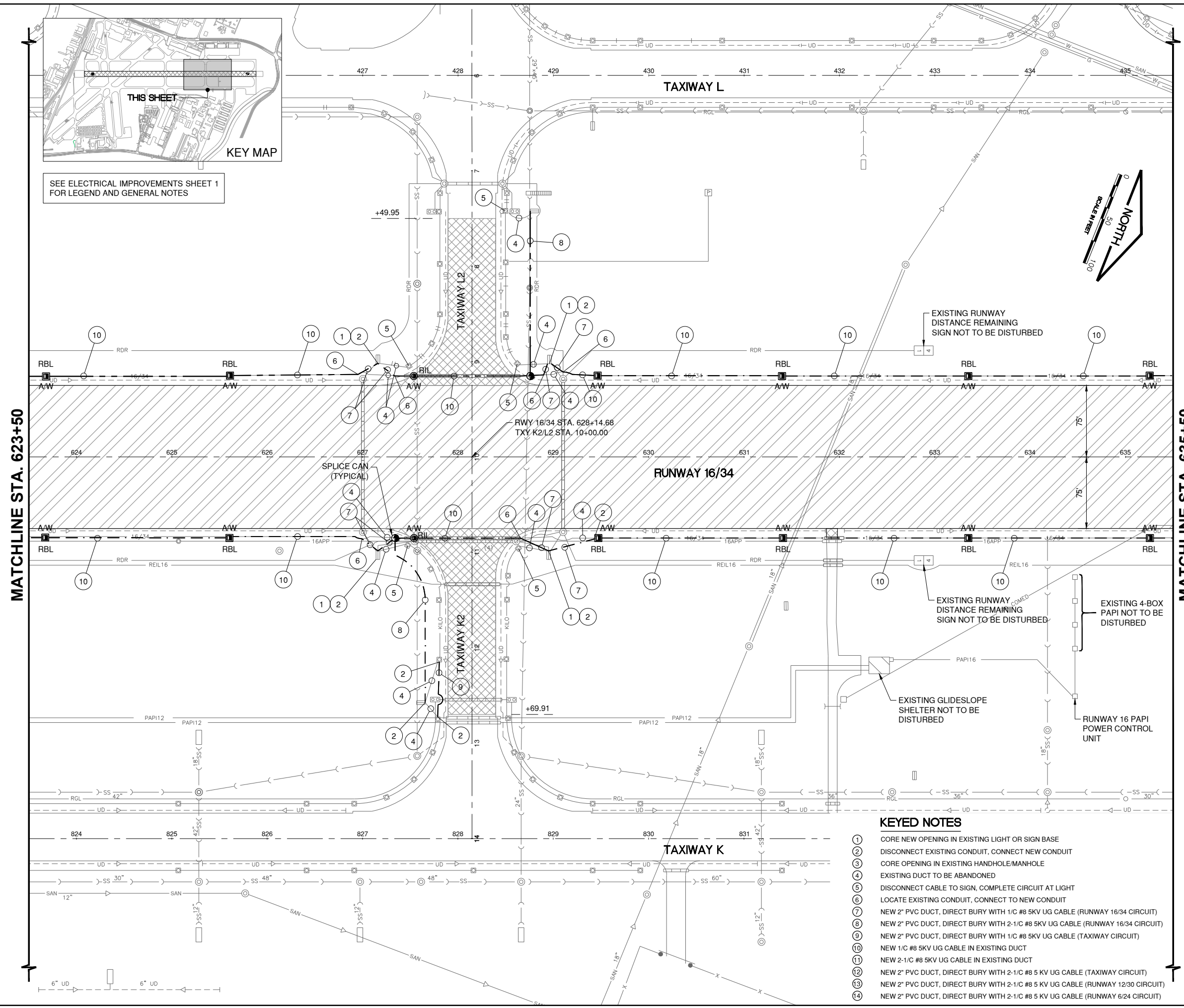

SEE ELECTRICAL IMPROVEMENTS SHEET 1 FOR LEGEND AND GENERAL NOTES

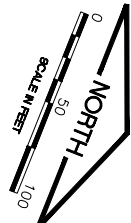
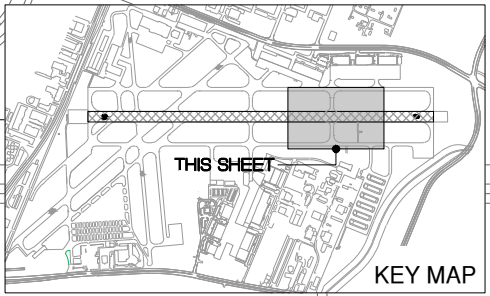

- KEYED NOTES**
- 1 CORE NEW OPENING IN EXISTING LIGHT OR SIGN BASE
 - 2 DISCONNECT EXISTING CONDUIT, CONNECT NEW CONDUIT
 - 3 CORE OPENING IN EXISTING HANDHOLE/MANHOLE
 - 4 EXISTING DUCT TO BE ABANDONED
 - 5 DISCONNECT CABLE TO SIGN, COMPLETE CIRCUIT AT LIGHT
 - 6 LOCATE EXISTING CONDUIT, CONNECT TO NEW CONDUIT
 - 7 NEW 2" PVC DUCT, DIRECT BURY WITH 1/C #8 5KV UG CABLE (RUNWAY 16/34 CIRCUIT)
 - 8 NEW 2" PVC DUCT, DIRECT BURY WITH 2-1/C #8 5KV UG CABLE (RUNWAY 16/34 CIRCUIT)
 - 9 NEW 2" PVC DUCT, DIRECT BURY WITH 1/C #8 5KV UG CABLE (TAXIWAY CIRCUIT)
 - 10 NEW 1/C #8 5KV UG CABLE IN EXISTING DUCT
 - 11 NEW 2-1/C #8 5KV UG CABLE IN EXISTING DUCT
 - 12 NEW 2" PVC DUCT, DIRECT BURY WITH 2-1/C #8 5 KV UG CABLE (TAXIWAY CIRCUIT)
 - 13 NEW 2" PVC DUCT, DIRECT BURY WITH 2-1/C #8 5 KV UG CABLE (RUNWAY 12/30 CIRCUIT)
 - 14 NEW 2" PVC DUCT, DIRECT BURY WITH 2-1/C #8 5 KV UG CABLE (RUNWAY 6/24 CIRCUIT)

IL CONTRACT: PA059
 IL LETTING ITEM: 18A
 IL PROJECT: PWK-4414
 S.B.G. PROJECT: 3-17-SBGP-XX

SURVEY BOOK # 1302

REVISIONS		
NUMBER	BY	DATE

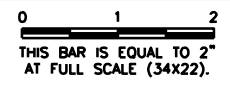

**CHICAGO EXECUTIVE AIRPORT
 WHEELING/PROSPECT HEIGHTS, ILLINOIS
 REHABILITATE RUNWAY 16/34**

ELECTRICAL IMPROVEMENTS SHEET 4

© Copyright CMT, Inc.

CMT
 CRAWFORD, MURPHY & TILLY, INC.
 CONSULTING ENGINEERS
 License No. 184-000613

CHICAGO EXECUTIVE AIRPORT

DESIGN BY:	SMS
DRAWN BY:	JRO
CHECKED BY:	SMS
APPROVED BY:	DKP
DATE:	06/19/2015
JOB No:	14290-05-00

FINAL

DATE: Thursday, July 9, 2015, 09:43:47
 FILE: K:\Chicago\rev\14290-05_RehabRW16-34\Draw\Sheets\48-52_ELEC_IMP.dwg
 UPDATE BY: Sean Smith
 LAYOUT: ELEC 5
 REF DWG: runway_16_34_base-NEW.dwg
 TYPICAL: runway.dwg
 IMAGE FILES: pwknewLOGO_CEA-4-Color-Small (2).jpg
 runway_16-34_electrical_base.dwg

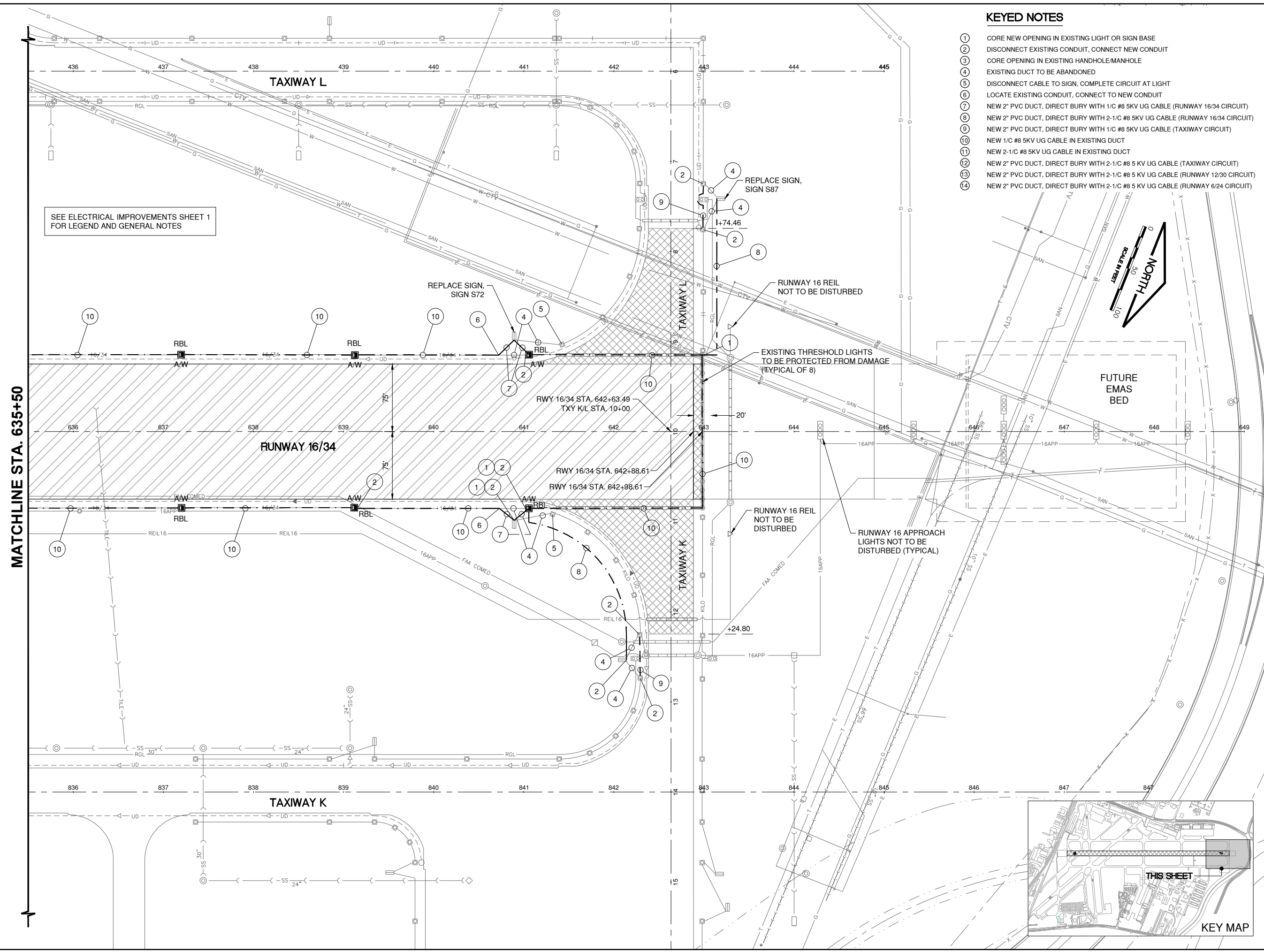

SEE ELECTRICAL IMPROVEMENTS SHEET 1 FOR LEGEND AND GENERAL NOTES

MATCHLINE STA. 635+50

- KEYED NOTES**
- ① CORE NEW OPENING IN EXISTING LIGHT OR SIGN BASE
 - ② DISCONNECT EXISTING CONDUIT, CONNECT NEW CONDUIT
 - ③ CORE OPENING IN EXISTING HANDHOLE/MANHOLE
 - ④ EXISTING DUCT TO BE ABANDONED
 - ⑤ DISCONNECT CABLE TO SIGN, COMPLETE CIRCUIT AT LIGHT
 - ⑥ LOCATE EXISTING CONDUIT, CONNECT TO NEW CONDUIT
 - ⑦ NEW 2" PVC DUCT, DIRECT BURY WITH 1/2" #8 5KV UG CABLE (RUNWAY 16/34 CIRCUIT)
 - ⑧ NEW 2" PVC DUCT, DIRECT BURY WITH 2-1/2" #8 5KV UG CABLE (RUNWAY 16/34 CIRCUIT)
 - ⑨ NEW 2" PVC DUCT, DIRECT BURY WITH 1/2" #8 5KV UG CABLE (TAXIWAY CIRCUIT)
 - ⑩ NEW 1/2" #8 5KV UG CABLE IN EXISTING DUCT
 - ⑪ NEW 2-1/2" #8 5KV UG CABLE IN EXISTING DUCT
 - ⑫ NEW 2" PVC DUCT, DIRECT BURY WITH 2-1/2" #8 5KV UG CABLE (TAXIWAY CIRCUIT)
 - ⑬ NEW 2" PVC DUCT, DIRECT BURY WITH 2-1/2" #8 5KV UG CABLE (RUNWAY 12/30 CIRCUIT)
 - ⑭ NEW 2" PVC DUCT, DIRECT BURY WITH 2-1/2" #8 5KV UG CABLE (RUNWAY 6/24 CIRCUIT)

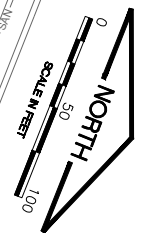

IL. CONTRACT: **PA059**
 IL. LETTING ITEM: **18A**
 IL. PROJECT: **PWK-4414**
 S.B.G. PROJECT: **3-17-SBGP-XX**

SURVEY BOOK # 1302

REVISIONS		
NUMBER	BY	DATE

CHICAGO EXECUTIVE AIRPORT
WHEELING/PROSPECT HEIGHTS, ILLINOIS
REHABILITATE RUNWAY 16/34
ELECTRICAL IMPROVEMENTS SHEET 5

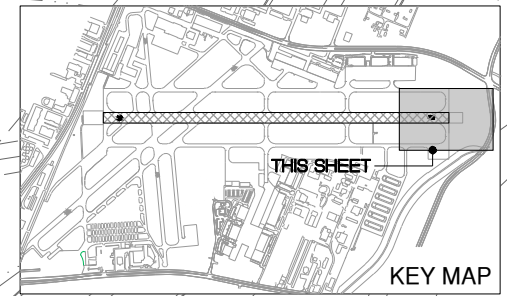

© Copyright CMT, Inc.

CMT
 CRAWFORD, MURPHY & TILLY, INC.
 CONSULTING ENGINEERS
 License No. 184-000613

CHICAGO EXECUTIVE AIRPORT

DESIGN BY:	SMS
DRAWN BY:	JRO
CHECKED BY:	SMS
APPROVED BY:	DKP
DATE:	06/19/2015
JOB No:	14290-05-00

FINAL

SHEET 52 OF 58 SHEETS

DATE: Thursday, July 9, 2015 09:50:17
 FILE: K:\Chicago\checkp\14290-05-Relat\RW16-34 (Draw) Sheets\53 HOMERUN PLAN.dwg
 UPDATE BY: Sean Smith
 LAYOUT: HOMERUN PLAN
 XREF DWG: bchrt_runway.dwg
 C:\Users\jro\Documents\6m.dwg
 6m.dwg
 IMAGE FILES: pwknew\LOGO_CEA-4-Color-Small (2).jpg

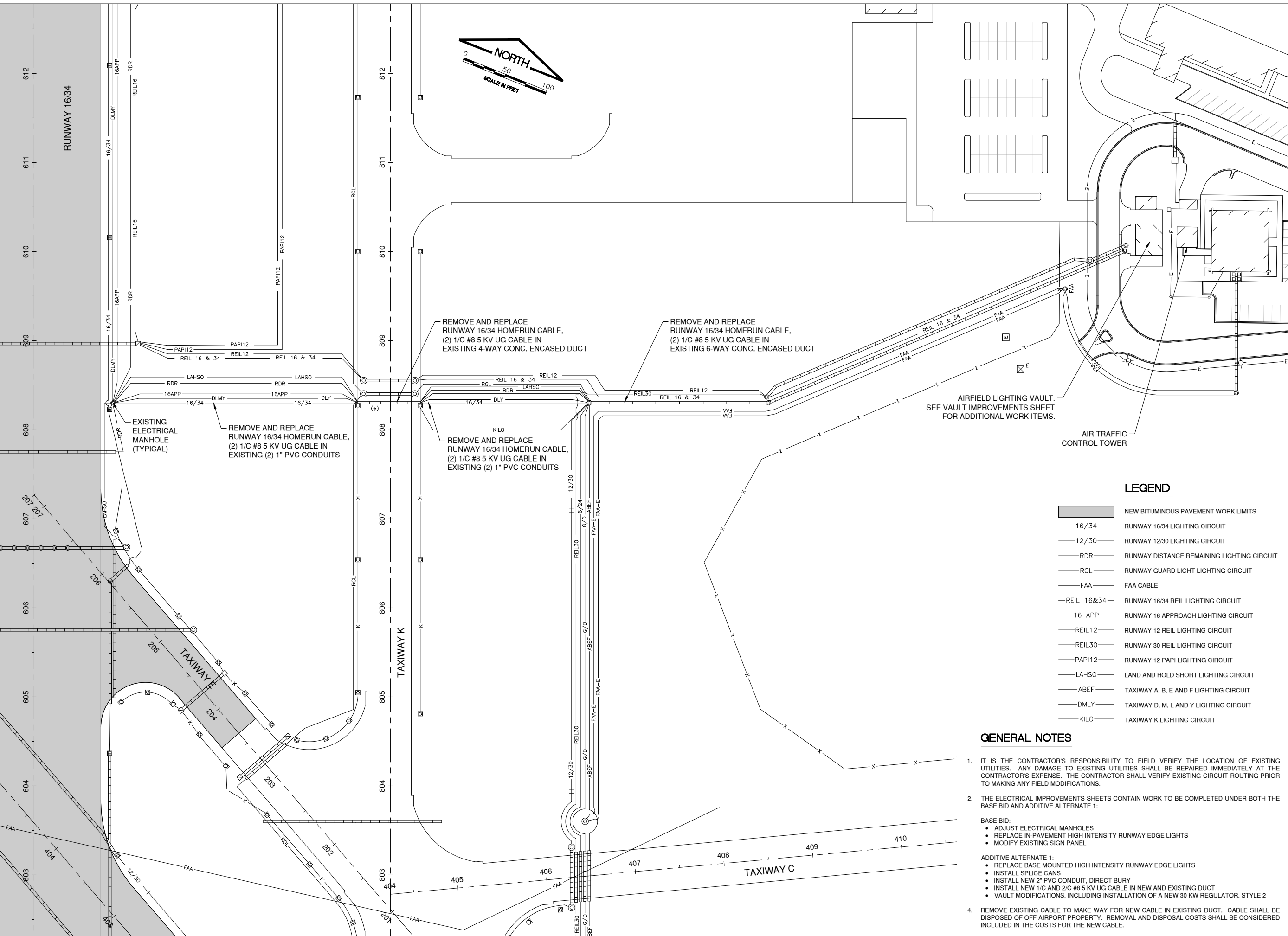

IL. CONTRACT: **PA059**
 IL. LETTING ITEM: **18A**
 IL. PROJECT: **PWK-4414**
 S.B.G. PROJECT: **3-17-SBGP-XX**

SURVEY BOOK # 1302

REVISIONS		
NUMBER	BY	DATE

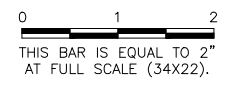

**CHICAGO EXECUTIVE AIRPORT
 WHEELING/PROSPECT HEIGHTS, ILLINOIS
 REHABILITATE RUNWAY 16/34**

RUNWAY 16/34 HOMERUN PLAN

LEGEND

- NEW BITUMINOUS PAVEMENT WORK LIMITS
- 16/34 RUNWAY 16/34 LIGHTING CIRCUIT
- 12/30 RUNWAY 12/30 LIGHTING CIRCUIT
- RDR RUNWAY DISTANCE REMAINING LIGHTING CIRCUIT
- RGL RUNWAY GUARD LIGHT LIGHTING CIRCUIT
- FAA FAA CABLE
- REIL 16&34 RUNWAY 16/34 REIL LIGHTING CIRCUIT
- 16 APP RUNWAY 16 APPROACH LIGHTING CIRCUIT
- REIL12 RUNWAY 12 REIL LIGHTING CIRCUIT
- REIL30 RUNWAY 30 REIL LIGHTING CIRCUIT
- PAPI12 RUNWAY 12 PAPI LIGHTING CIRCUIT
- LAHSO LAND AND HOLD SHORT LIGHTING CIRCUIT
- ABEF TAXIWAY A, B, E AND F LIGHTING CIRCUIT
- DMLY TAXIWAY D, M, L AND Y LIGHTING CIRCUIT
- KILO TAXIWAY K LIGHTING CIRCUIT

GENERAL NOTES

- IT IS THE CONTRACTOR'S RESPONSIBILITY TO FIELD VERIFY THE LOCATION OF EXISTING UTILITIES. ANY DAMAGE TO EXISTING UTILITIES SHALL BE REPAIRED IMMEDIATELY AT THE CONTRACTOR'S EXPENSE. THE CONTRACTOR SHALL VERIFY EXISTING CIRCUIT ROUTING PRIOR TO MAKING ANY FIELD MODIFICATIONS.
- THE ELECTRICAL IMPROVEMENTS SHEETS CONTAIN WORK TO BE COMPLETED UNDER BOTH THE BASE BID AND ADDITIVE ALTERNATE 1:
 - BASE BID:
 - ADJUST ELECTRICAL MANHOLES
 - REPLACE IN-PAVEMENT HIGH INTENSITY RUNWAY EDGE LIGHTS
 - MODIFY EXISTING SIGN PANEL
 - ADDITIVE ALTERNATE 1:
 - REPLACE BASE MOUNTED HIGH INTENSITY RUNWAY EDGE LIGHTS
 - INSTALL SPLICE CANS
 - INSTALL NEW 2" PVC CONDUIT, DIRECT BURY
 - INSTALL NEW 1/C AND 2/C #8 5 KV UG CABLE IN NEW AND EXISTING DUCT
 - VAULT MODIFICATIONS, INCLUDING INSTALLATION OF A NEW 30 KW REGULATOR, STYLE 2
- REMOVE EXISTING CABLE TO MAKE WAY FOR NEW CABLE IN EXISTING DUCT. CABLE SHALL BE DISPOSED OF OFF AIRPORT PROPERTY. REMOVAL AND DISPOSAL COSTS SHALL BE CONSIDERED INCLUDED IN THE COSTS FOR THE NEW CABLE.

© Copyright CMT, Inc.

CMT
 CRAWFORD, MURPHY & TILLY, INC.
 CONSULTING ENGINEERS
 License No. 184-000613

CHICAGO EXECUTIVE AIRPORT

DESIGN BY:	SMS
DRAWN BY:	JRO
CHECKED BY:	SMS
APPROVED BY:	DKP
DATE:	06/19/2015
JOB No:	14290-05-00

FINAL

DATE: Thursday, July 9, 2015 09:50:35
 FILE: K:\Chicago\Exec\14290-05_RehabRW16-34\Drawn Sheets\54_Vault.dwg
 UPDATE BY: Sean Smith
 LAYOUT: VAULT

PROPOSED VAULT NOMENCLATURE

- ① EXISTING 30KW (5-STEP) REGULATOR FOR RUNWAY 16/34 TO BE RELOCATED TO ⑲.
- ② EXISTING 20KW (5-STEP) REGULATOR FOR RUNWAY 6/24.
- ③ EXISTING 20KW (5-STEP) REGULATOR FOR RUNWAY 12/30.
- ④ EXISTING 10KW (3-STEP) REGULATOR FOR TAXIWAY G,D AND 34 HOLD APRON.
- ⑤ EXISTING 10KW (3-STEP) REGULATOR FOR RUNWAY 16/34 RDR.
- ⑥ EXISTING 15KW (3-STEP) REGULATOR FOR RUNWAY 16/34 RGL.
- ⑦ EXISTING 10 KW (3-STEP) REGULATOR FOR RUNWAY 16 APPROACH LIGHTING TO BE REMOVED.**
- ⑧ EXISTING 10 KW (3-STEP) REGULATOR FOR HFC APRON LIGHTING.
- ⑨ EXISTING 30KW (5-STEP) SPARE REGULATOR TO BE RELOCATED TO ⑳.**
- ⑩ EXISTING 20KW (3-STEP) REGULATOR FOR TAXIWAY K.
- ⑪ EXISTING 30 KW (5-STEP) REGULATOR FOR SPARE.
- ⑫ EXISTING 30KW (3-STEP) REGULATOR FOR TAXIWAY D,L,M,N AND Y.
- ⑬ EXISTING 10KW (3-STEP) REGULATOR FOR TAXIWAY C.
- ⑭ FUTURE AIRFIELD LIGHTING REGULATOR.
- ⑮ EXISTING MAIN UTILITY SERVICE CIRCUIT BREAKER DISCONNECT. 800A, 480V, 3-POLE.
- ⑯ EXISTING AUTOMATIC TRANSFER SWITCH. 800A, 480V, 3-POLE.
- ⑰ EXISTING HIGH VOLTAGE POWER DISTRIBUTION PANEL. 480V, 3-PHASE WITH 800AMP MAIN CIRCUIT BREAKER. INSTALL NEW 1-100A, 2-POLE CIRCUIT BREAKER IN EXISTING PANELBOARD.**
- ⑱ EXISTING 150KVA, 480V-280Y/120V, 3ø, 4-WIRE TRANSFORMER.
- ⑲ EXISTING LOW VOLTAGE LIGHTING PANEL. 208Y/120V, 3-PHASE WITH 400AMP MAIN CIRCUIT BREAKER.
- ⑳ EXISTING PLC CONTROL CABINET.
- ㉑ EXISTING 800AMP CT CABINET.
- ㉒ EXISTING 12"x12"x12' LONG HIGH VOLTAGE WIREWAY. HOMERUN CABLES FOR PROPOSED RUNWAY 16/34 CIRCUIT SHALL BE TIED INTO SECONDARY CABLES FROM REGULATOR IN WIREWAY USING L-823 CONNECTORS. CONNECTORS SHALL BE TAPED AND LABELED.**
- ㉓ EXISTING 12"x12"x12' LONG LOW VOLTAGE WIREWAY.
- ㉔ EXISTING 12"x12"x9' LONG HIGH VOLTAGE WIREWAY.
- ㉕ EXISTING 12"x12"x9' LONG LOW VOLTAGE WIREWAY.
- ㉖ EXISTING 30KW (3-STEP) REGULATOR FOR TAXIWAY A,B,D,E,F AND Y.
- ㉗ RELOCATE 30KW (5-STEP) REGULATOR FOR SPARE (STAND BY) USE.**
- ㉘ NEW 30KW (5-STEP) REGULATOR FOR RUNWAY 16/34.**
- ㉙ RELOCATE EXISTING 30KW (5-STEP) REGULATOR FOR SPARE USE.**
- ㉚ INSTALL NEW 2-1/C #8 5KV, L-824 CABLES IN EXISTING CONDUIT FROM NEW 30KW SPARE REGULATOR TO HIGH VOLTAGE WIREWAY. INSTALL L-823 CONNECTORS.**
- ㉛ REMOVE EXISTING POWER CABLES FOR RUNWAY 16 APPROACH REGULATOR AND INSTALL NEW 2-1/C #2 THWN, 1-1/C #6 GND. FOR NEW SPARE REGULATOR IN EXISTING CONDUIT.**

NOTES:

1. ALL PROPOSED WORK OR ITEMS BEING MODIFIED ARE SHOWN IN BOLD. ALL OTHER ITEMS SHOWN ARE FOR INFORMATIONAL PURPOSES ONLY.
2. CONTRACTOR SHALL REMOVE EXISTING 10KW REGULATOR (RUNWAY 16 APPROACH) AND DISPOSE OF IT OFF OF AIRPORT PROPERTY.
3. CONTRACTOR SHALL RELOCATE EXISTING 30KW REGULATOR FOR RUNWAY 16/34 TO LOCATION OF EXISTING 30KW SPARE REGULATOR AND REPLACE WITH NEW 30KW REGULATOR FOR RUNWAY 16/34.
4. CONNECT EXISTING POWER AND CONTROLS FOR RUNWAY 16/34 AND SPARE REGULATORS.
5. CONTRACTOR SHALL REMOVE EXISTING 10KW REGULATOR FOR RUNWAY 16 APPROACH AND RELOCATE EXISTING 30KW SPARE REGULATOR TO ITS LOCATION.

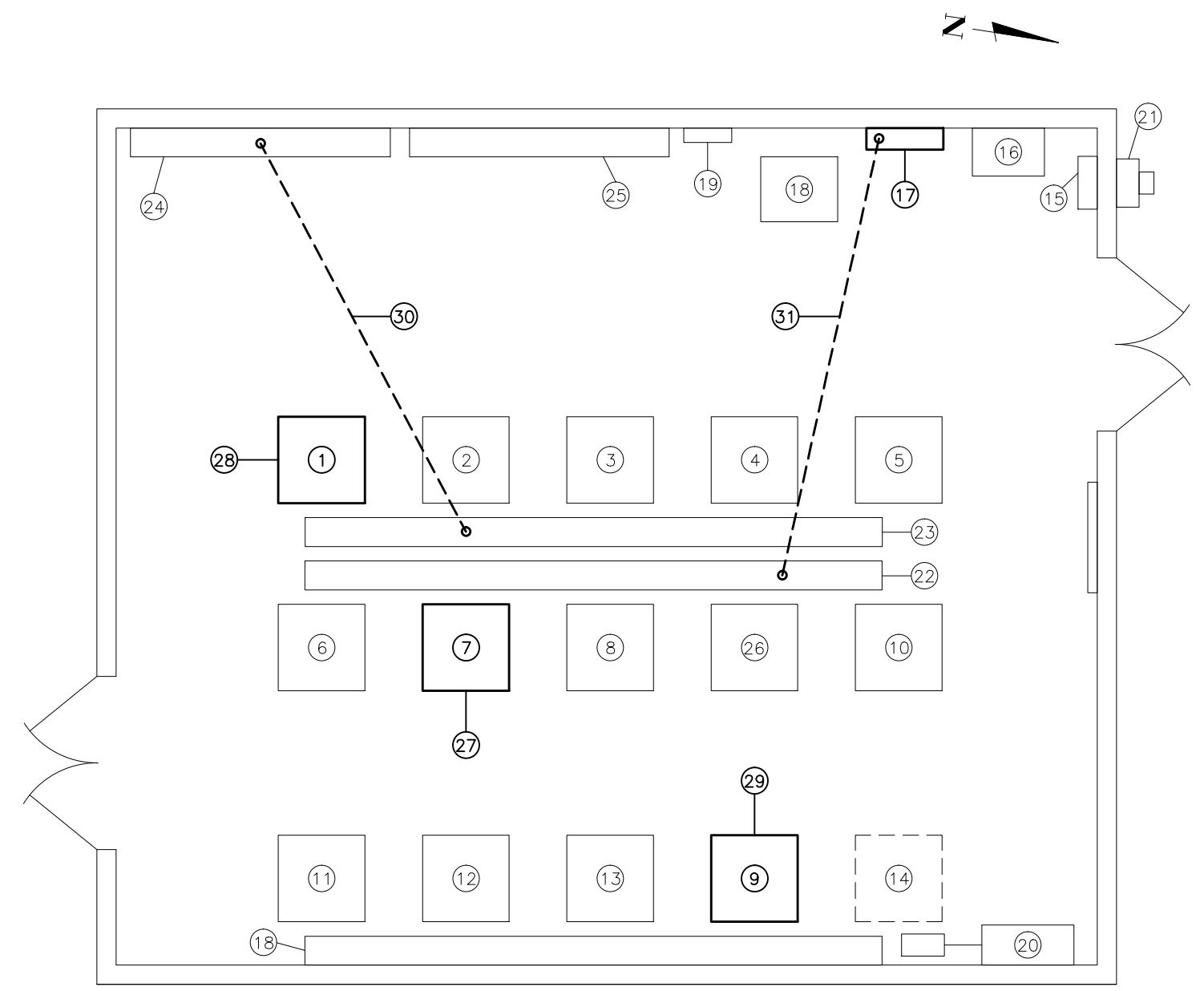

PROP. AIRFIELD ELECT. VAULT PLAN VIEW
 1/4" = 1'-0"

IL. CONTRACT: **PA059**
 IL. LETTING ITEM: **18A**
 IL. PROJECT: **PWK-4414**
 S.B.G. PROJECT: **3-17-SBGP-XX**

SURVEY BOOK # 1302

REVISIONS		
NUMBER	BY	DATE

0 1 2
 THIS BAR IS EQUAL TO 2"
 AT FULL SCALE (34X22).

**CHICAGO EXECUTIVE AIRPORT
 WHEELING/PROSPECT HEIGHTS, ILLINOIS
 REHABILITATE RUNWAY 16/34**

VAULT IMPROVEMENTS

© Copyright CMT, Inc.

CMT
 CRAWFORD, MURPHY & TILLY, INC.
 CONSULTING ENGINEERS
 License No. 184-000613

CHICAGO EXECUTIVE AIRPORT

DESIGN BY:	SMS
DRAWN BY:	JRO
CHECKED BY:	SMS
APPROVED BY:	DKP
DATE:	06/19/2015
JOB No:	14290-05-00

FINAL

SHEET 54 OF 58 SHEETS

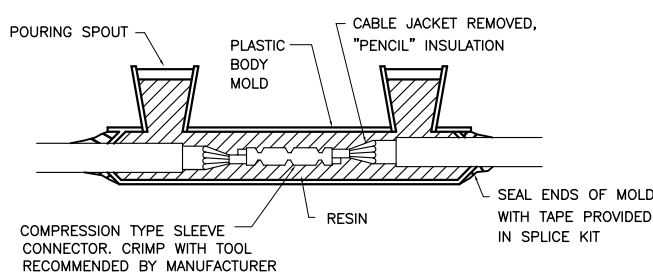

TYPE A - CABLE SPLICE

FOR SPLICES IN HOMERUNS AND FOR EXTENSIONS TO EXISTING CABLES ONLY
NOT TO SCALE

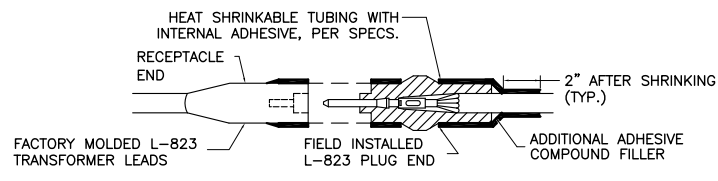

TYPE C AND D - CABLE SPLICE

FOR SPLICES AT RUNWAY/TAXIWAY LIGHTS AND SIGNS
NOT TO SCALE

SPLICE NOTES

- INSIDE DIAMETER OF CONNECTOR SHALL PROPERLY MATCH THE OUTSIDE DIAMETER OF CABLE.
- WRAP WITH AT LEAST ONE LAYER OF RUBBER OR SYNTHETIC RUBBER TAPE AND ONE LAYER OF PLASTIC TAPE, ONE-HALF LAPPED, EXTENDING AT LEAST 1-1/2 INCHES ON EACH SIDE OF JOINT.
- THE COST OF FURNISHING AND INSTALLING ALL SPLICE MATERIALS SHALL BE INCIDENTAL TO THE ASSOCIATED CABLE ITEMS.
- THE CONTRACTOR SHALL HAVE A MINIMUM OF FIVE (5) TYPE A SPLICE KITS ON THE JOB SITE AT ALL TIMES FOR EMERGENCY REPAIRS.
- THE CONTRACTOR MAY ELECT TO USE AN FAA APPROVED PRIMARY CONNECTOR KIT IN LIEU OF HEAT SHRINK KIT AT NO ADDITIONAL COST.

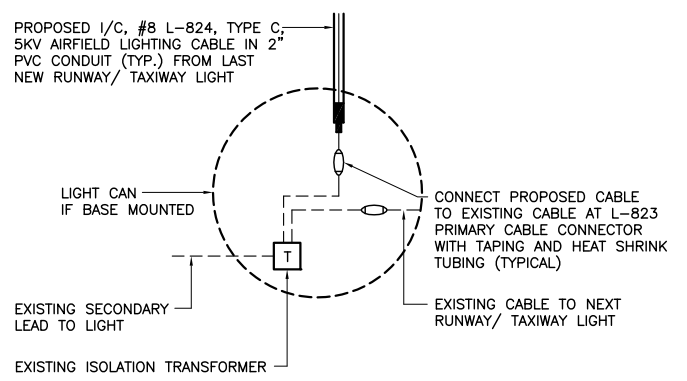

RUNWAY/TAXIWAY LIGHTING CIRCUIT CONNECTION DETAIL

NOT TO SCALE

SEE ELECTRICAL DETAILS SHEET 2 FOR GENERAL ELECTRICAL NOTES

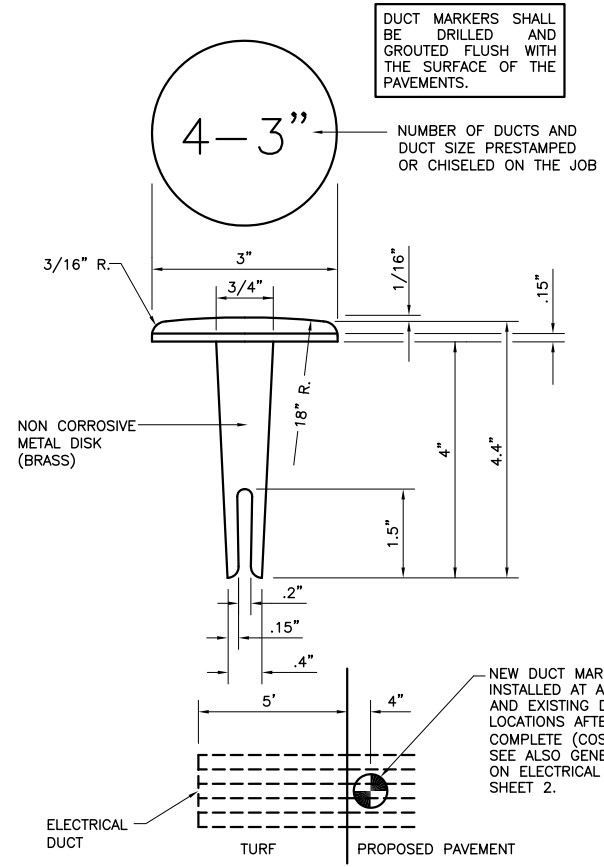

DUCT MARKER DETAIL

NOT TO SCALE

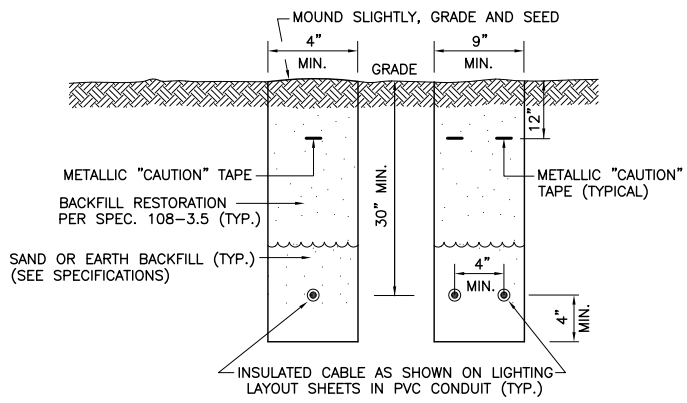

TRENCH NOTES

- TRENCHES WITH MORE THAN 2 CABLES SHALL BE INCREASED 3" IN WIDTH FOR EACH ADDITIONAL CABLE. IF SPECIFIED ON PLANS, TWO PARALLEL TRENCHES MAY BE CONSTRUCTED.
- DEPTH OF TRENCHES SHALL BE AS SHOWN UNLESS OTHERWISE SPECIFIED ON THE PLANS.
- SAND BACKFILL SHALL BE USED IF THE EXISTING SOIL DOES NOT MEET THE BACKFILL REQUIREMENTS.
- ALL DISTURBED SURFACES SHALL BE RESTORED TO THEIR ORIGINAL CONDITION. COST IS INCIDENTAL TO THE CONDUIT AND CABLE INSTALLATION.

TRENCH DETAIL

NOT TO SCALE

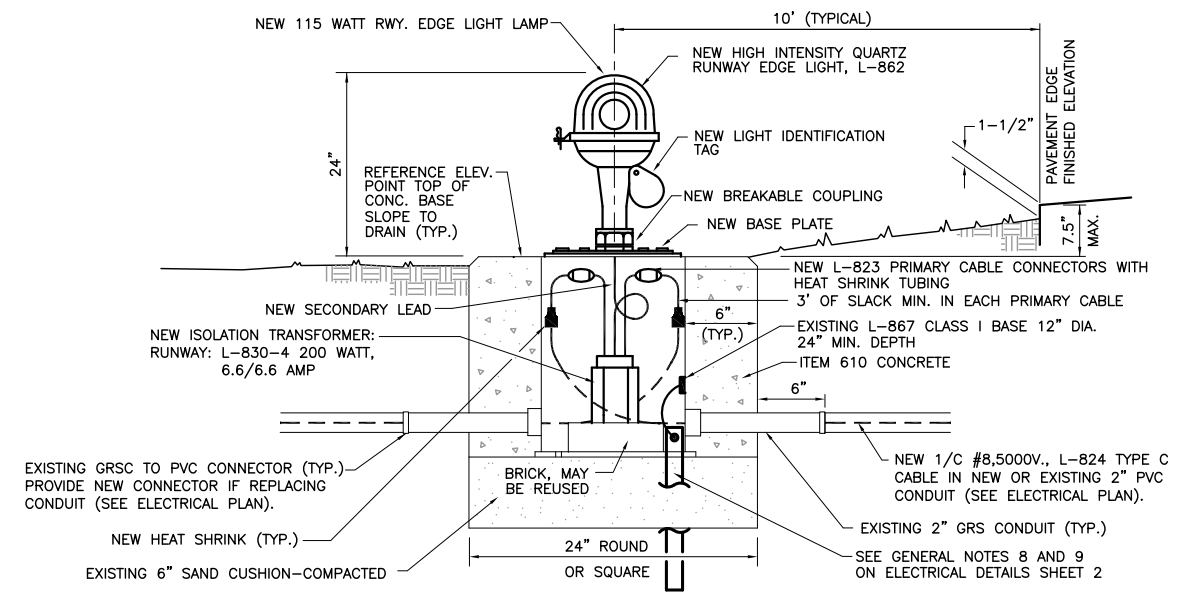

REPLACE BASE MOUNTED HIGH INTENSITY RUNWAY LIGHT

NOT TO SCALE

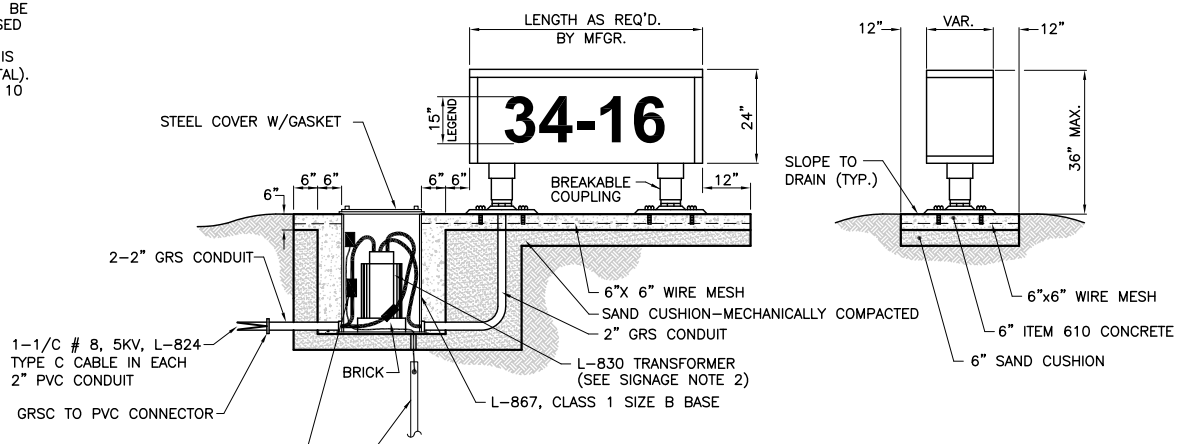

REPLACE AIRFIELD GUIDANCE SIGN, L-858 (LED)

NOT TO SCALE

SIGNAGE NOTES

- ALL SIGNS ARE 2-SIDED LED SIGNS, CLASS 2 AS MANUFACTURED BY ADB OR APPROVED EQUAL. SIGNS SHALL BE CAPABLE OF BEING CONNECTED TO A 3-STEP OR 5-STEP REGULATOR.
- TRANSFORMER WATTAGE AS RECOMMENDED BY MANUFACTURER FOR LED SIGNS.
- LIGHTED SIGNS SHALL BE BASE MOUNTED ONLY.
- THE NUMBER OF MODULES PER SIGN SHALL BE AS RECOMMENDED BY THE MANUFACTURER.
- CONTRACTOR SHALL SUBMIT DETAILED SHOP DRAWINGS INCLUDING SIGN, COLOR, SIZE AND PROPOSED LEGEND, IN ENOUGH DETAIL TO DETERMINE PROPOSED SPACING AND OTHER INFORMATION REQUIRED BY THE SPECIAL PROVISIONS.
- CONTRACTOR TO VERIFY PROPOSED SIGN LOCATIONS AND ORIENTATIONS WITH RESIDENT ENGINEER PRIOR TO INSTALLATION.
- REPLACE TAXI GUIDANCE SIGN SHALL INCLUDE THE COMPLETE REMOVAL AND DISPOSAL OF THE EXISTING SIGN FOUNDATION. SIGN UNITS SHALL BE TURNED OVER THE AIRPORT FOR STOCK.

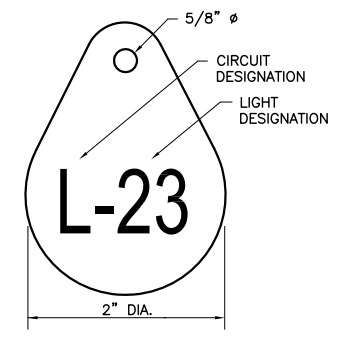

LIGHT IDENTIFICATION DETAIL

NOT TO SCALE

NOTES

- INSTALL A NON-CORROSIVE DISC OF 2" MINIMUM DIAMETER WITH THE NUMBER PERMANENTLY STAMPED, CUT OUT, OR ENGRAVED UNDER THE HEAD OF THE BASE PLATE BOLT OR ATTACHED TO LIGHT FLANGE WITH A SET SCREW.
- NUMERALS SHOWN ARE FOR ILLUSTRATIVE PURPOSES ONLY. ALL EXISTING AND PROPOSED TAXIWAY AND RUNWAY LIGHTS AND SIGNS SHALL BE TAGGED AS DIRECTED BY THE RESIDENT ENGINEER. ALL LIGHTS ON EXISTING CIRCUITS THAT HAVE LIGHTING IMPROVEMENTS (PROPOSED OR RELOCATED LIGHTS) SHALL BE RETAGGED.
- COST OF TAGGING LIGHTS SHALL NOT BE PAID FOR SEPARATELY BUT SHALL BE CONSIDERED INCIDENTAL TO THE CONTRACT.

IL CONTRACT: PA059
IL LETTING ITEM: 18A
IL PROJECT: PWK-4414
S.B.G. PROJECT: 3-17-SBGP-XX

SURVEY BOOK # 1302

REVISIONS

NUMBER	BY	DATE

0 1 2
THIS BAR IS EQUAL TO 2" AT FULL SCALE (34X22).

CHICAGO EXECUTIVE AIRPORT
WHEELING/PROSPECT HEIGHTS, ILLINOIS
REHABILITATE RUNWAY 16/34

ELECTRICAL DETAILS
SHEET 1

© Copyright CMT, Inc.



CRAWFORD, MURPHY & TILLY, INC.
CONSULTING ENGINEERS
License No. 184-000613



DESIGN BY:	MH
DRAWN BY:	JRO
CHECKED BY:	SMS
APPROVED BY:	DKP
DATE:	06/19/2015
JOB No:	14290-05-00

FINAL

DATE: Thursday, July 9, 2015 09:51:16
 FILE: K:\Chicago\Exec\14290-05-RehabRWY16-34\Draw\Sheets\66-ELEC.DETS 2.dwg
 UPDATE BY: Sean Smith
 LAYOUT: ELEC.DETS 2
 IMAGE FILES: pwknewLOGO_CEA-4-Color-Small (2).jpg
 XREF DWG: bchm_ranwoy.dwg

GENERAL NOTES

1. CONCRETE BASES FOR BASE MOUNTED LIGHTS, SIGNS AND SPLICE CANS SHALL BE TROWEL FINISHED WITH A 45° BEVELED EDGE. SLOPE TO DRAIN (ITEM 610).
2. TRANSFORMER HOLDER SHALL BE ANY COMMERCIALY AVAILABLE BRICK.
3. BREAKING GROOVE COUPLINGS SHALL NOT BE OVER 1" ABOVE GROUND LINE.
4. ISOLATION TRANSFORMERS COME WITH A FACTORY INSTALLED PLUG (TYPE 1, CLASS A, STYLE 2) AND RECEPTACLE (TYPE 1, CLASS A, STYLE 9). A TYPE 1, CLASS B, STYLE 3 PLUG AND TYPE 1, CLASS B, STYLE 10 RECEPTACLE SHALL BE INSTALLED ON THE 1/C #8 5 KV, L-824 TYPE C CABLES FOR CONNECTION TO EACH TRANSFORMER.
5. TO FURTHER REDUCE THE POSSIBILITY OF WATER/MOISTURE ENTRANCE INTO THE CONNECTOR AND BETWEEN THE CABLE AND THE FIELD ATTACHED CONNECTOR, IT IS REQUIRED THAT A HEAT SHRINKABLE TUBING WITH INTERNAL ADHESIVE BE APPLIED OVER THE ENTIRE CABLE CONNECTOR.
6. ALL SIGNS, LIGHTS AND TRANSFORMERS TO BE REMOVED SHALL REMAIN THE PROPERTY OF THE AIRPORT. AT THE DISCRETION OF THE AIRPORT DIRECTOR, THE CONTRACTOR MAY BE REQUIRED TO DISPOSE OF THESE MATERIALS OFFSITE.
7. ALL RUNWAY/TAXIWAY EDGE LIGHTS SHALL HAVE 2" DIAMETER COLUMN AND FRANGIBLE COUPLINGS, UNLESS OTHERWISE NOTED.
8. INSTALL SAFETY GROUND TO EXISTING SIGNS AND L-867 CANS. ATTACH GROUND LUG TO EXISTING CAN AND INSTALL GROUND ROD AS SHOWN ON PLANS.
9. INSTALL 1/C #6 AWG BARE COPPER GROUND JUMPER CONNECTED TO GROUND LUG INSIDE BASE CAN AND EXOTHERMICALLY WELDED TO GROUND ROD. INSTALL GROUND LUG FOR EXISTING CANS, IF REQUIRED.
10. CONTRACTOR SHALL SURVEY THE LOCATIONS OF THE EXISTING IN-PAVEMENT DUCT MARKERS PRIOR TO MILLING THE SURFACE. AFTER PAVING IS COMPLETE, NEW DUCT MARKERS SHALL BE REINSTALLED, COSTS INCIDENTAL.

AIRFIELD SIGNAGE SCHEDULE					
SIGN NUMBER	SIDE	EXISTING SIGN	FINAL MESSAGE	SIGN LOCATION	COMMENTS
S2	S N			RWY 16/34 STA. 598+24	MODIFY EXISTING 2-MODULE SIGN
S43	E W			RWY 12/30 STA. 408+33.91, 62.5' RT.	REPLACE SIGN AND BASE
S72	S N			RWY 16/34 STA. 640+89.50, 100' LT.	REPLACE SIGN AND BASE
S87	E W			TXY L STA. 7+41.40, 50, LT.	REPLACE SIGN AND BASE
S146	S N			RWY 16/34 STA. 594+38.50, 351.50' LT.	REPLACE SIGN AND BASE

SIGN COLOR DESCRIPTION

- BLACK ON YELLOW BACKGROUND
- YELLOW INSCRIPTION ON BLACK BACKGROUND
- WHITE INSCRIPTION WITH BLACK BORDER ON RED BACKGROUND
- BLANK PANEL

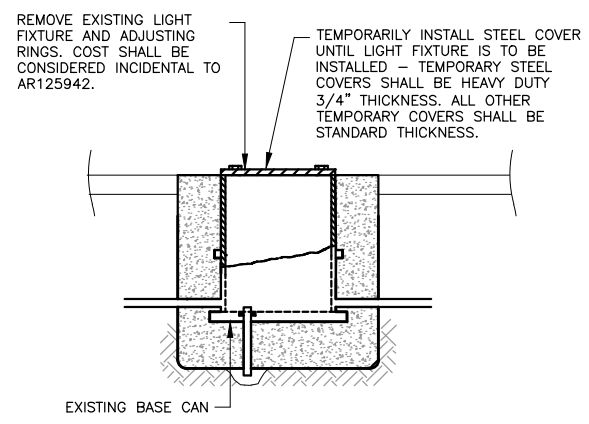

STEP 1

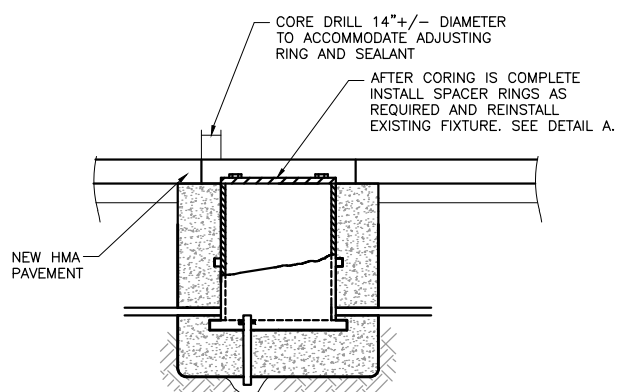

STEP 2

IN-PAVEMENT LIGHT INSTALLATION IN NEW BITUMINOUS PAVEMENT

NOT TO SCALE

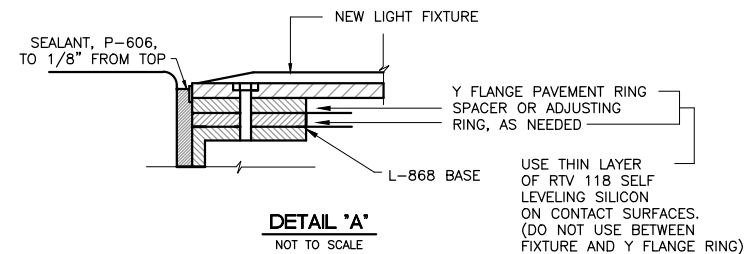

DETAIL "A"

NOT TO SCALE

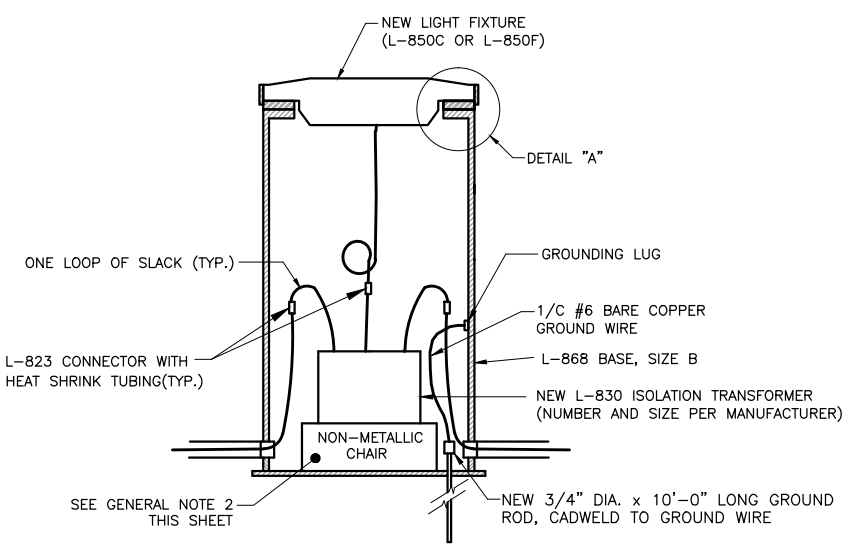

LIGHT FIXTURE INSTALLATION DETAIL

NOT TO SCALE

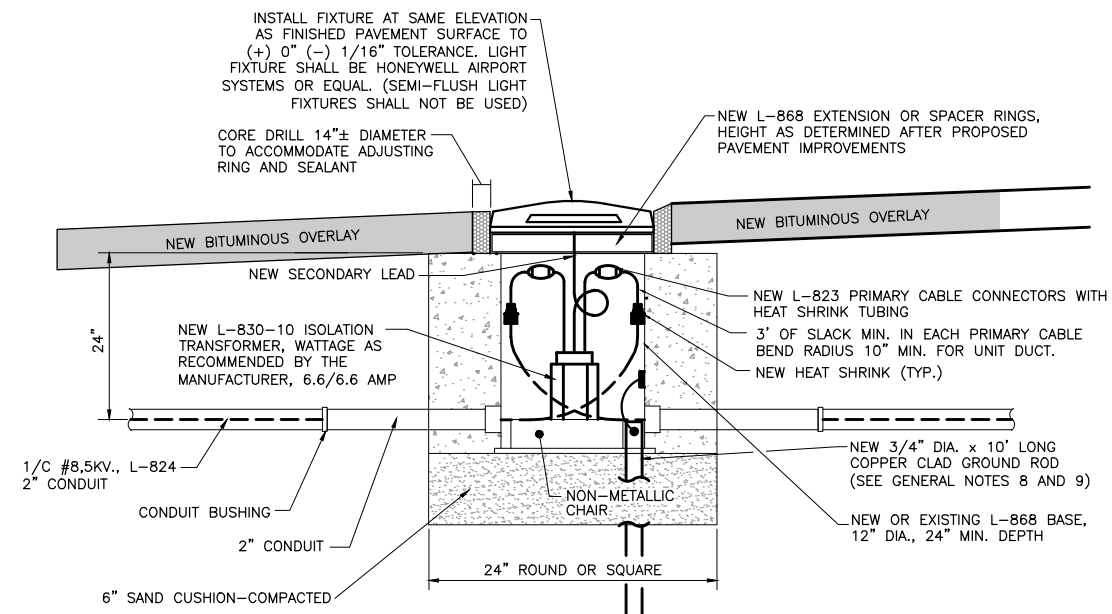

REPLACE HIGH INTENSITY RUNWAY EDGE LIGHT (IN-PAVEMENT), L-850C LAND AND HOLD SHORT OPERATION LIGHT INSTALLATION, L-850F

NOT TO SCALE

FOR ADDITIONAL LAND AND HOLD SHORT LIGHT INSTALLATION REQUIREMENTS, SEE ELECTRICAL DETAILS SHEET 3.

REPLACE HIGH INTENSITY RUNWAY EDGE LIGHT (IN-PAVEMENT) NOTES:

1. REMOVE EXISTING FIXTURE, TRANSFORMER AND EXTENSION/SPACER RINGS AND TURN OVER TO AIRPORT. INSTALL STEEL COVER PRIOR TO BEGINNING MILLING OPERATIONS.
2. PLACE FIRST AND SECOND LIFT OF BITUMINOUS SURFACE COURSE.
3. CORE DRILL 14"± DIAMETER TO ACCOMMODATE ADJUSTING RING AND SEALANT.
4. INSTALL ADJUSTING RING AND SPACERS IN ACCORDANCE WITH "IN-PAVEMENT LIGHT INSTALLATION IN BITUMINOUS PAVEMENT" DETAIL THIS SHEET.
5. INSTALL NEW LIGHT FIXTURE WITH NEW TRANSFORMER, PRIMARY CABLE CONNECTORS, HEAT SHRINK TUBING, GROUND LUG, GROUND WIRE AND GROUND ROD. NEW RUNWAY EDGE LIGHTS SHALL BE L-850C, LENS COLOR AS DENOTED ON PLANS.

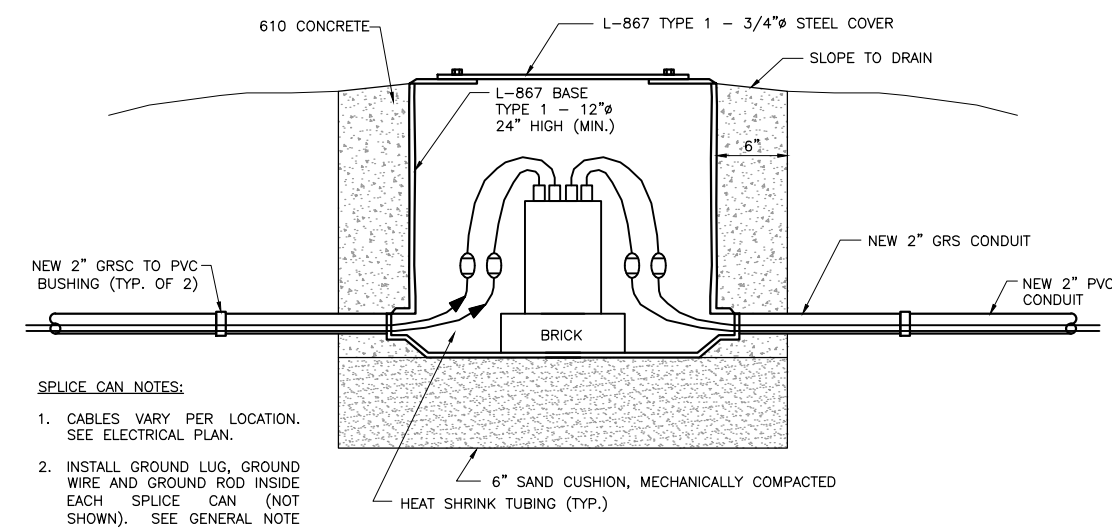

AIRFIELD SPLICE CAN

NOT TO SCALE

SPLICE CAN NOTES:

1. CABLES VARY PER LOCATION. SEE ELECTRICAL PLAN.
2. INSTALL GROUND LUG, GROUND WIRE AND GROUND ROD INSIDE EACH SPLICE CAN (NOT SHOWN). SEE GENERAL NOTE 9.
3. SOME SPLICE CANS MAY REQUIRE MORE CONDUIT STUBS THAN SHOWN IN THE DETAIL.

IL. CONTRACT: **PA059**
 IL. LETTING ITEM: **18A**
 IL. PROJECT: **PWK-4414**
 S.B.G. PROJECT: **3-17-SBGP-XX**

SURVEY BOOK # 1302

REVISIONS

NUMBER	BY	DATE

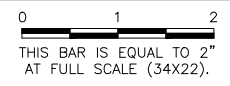

**CHICAGO EXECUTIVE AIRPORT
 WHEELING/PROSPECT HEIGHTS, ILLINOIS
 REHABILITATE RUNWAY 16/34**

**ELECTRICAL DETAILS
 SHEET 2**

© Copyright CMT, Inc.

CMT
 CRAWFORD, MURPHY & TILLY, INC.
 CONSULTING ENGINEERS
 License No. 184-000613

CHICAGO EXECUTIVE AIRPORT

DESIGN BY:	SMS
DRAWN BY:	JRO
CHECKED BY:	SMS
APPROVED BY:	DKP
DATE:	06/19/2015
JOB No:	14290-05-00

FINAL

DATE: Thursday, July 9, 2015 09:51:35
 FILE: K:\Chicago\electrical\14290-05-RehabRW16-3A\Drawn\Sheets\7 ELEC DETS 3.dwg
 UPDATE BY: Sean Smith
 LAYOUT: ELEC DETS 3
 REF DWG: bchm_ranmoy.dwg
 IMAGE FILES: pwknewLOGO_CEA-4-Color-Small (2).jpg

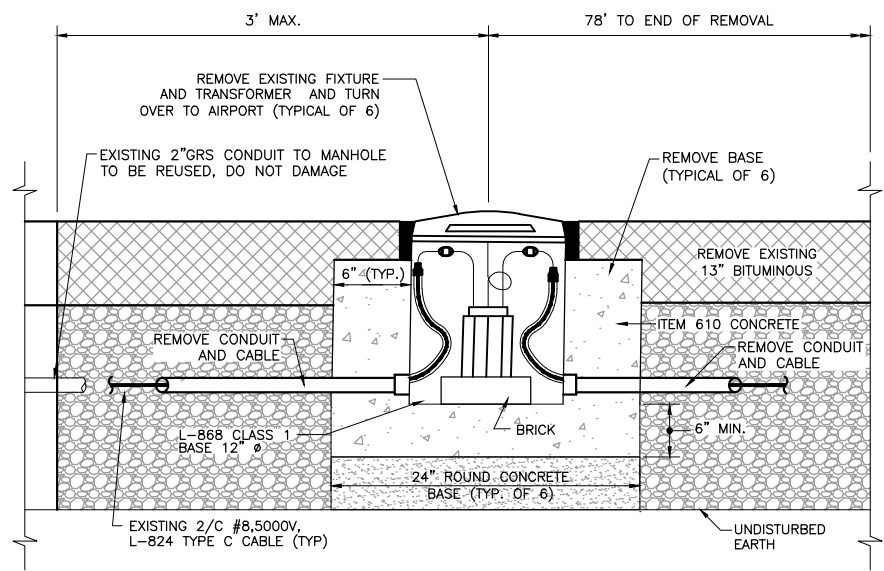

REMOVAL SECTION A-A
NOT TO SCALE

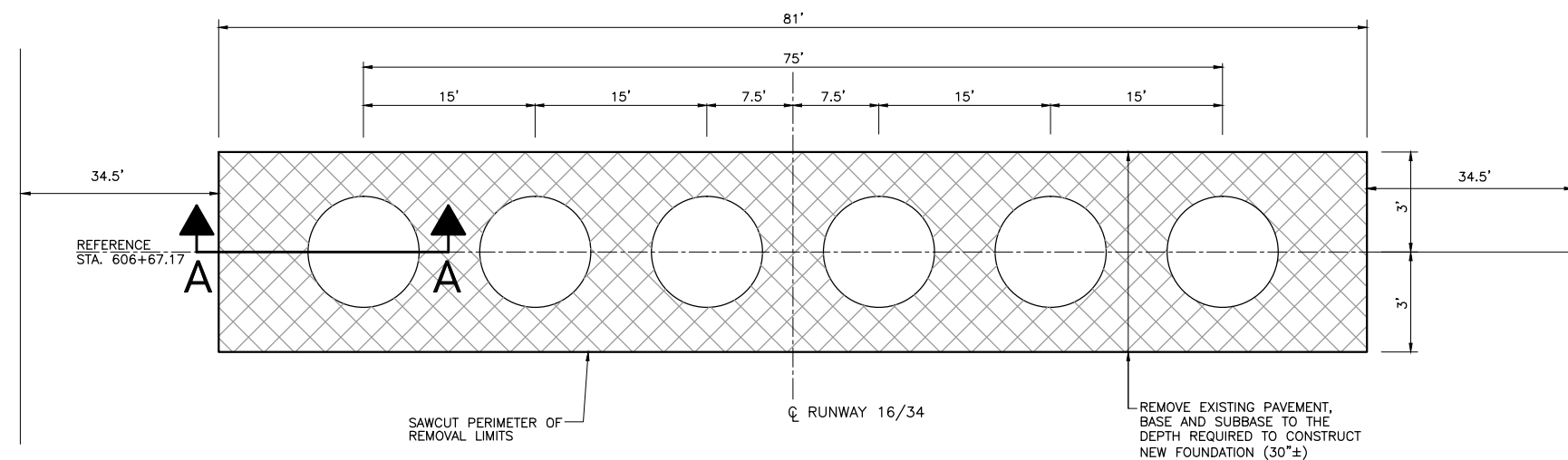

PLAN VIEW
REMOVE LAHSO LIGHT INSTALLATION (AR800131)
NOT TO SCALE

LAHSO REMOVAL AND INSTALLATION NOTES

- LAHSO REMOVAL SHALL INCLUDE REMOVAL OF EXISTING LIGHTS, TRANSFORMERS, CABLE, LIGHT BASE FOUNDATIONS, CONDUIT BETWEEN LIGHTS, AND PAVEMENT WITHIN THE LIMITS SHOWN.
- EXISTING LIGHTS AND TRANSFORMERS SHALL BE CAREFULLY REMOVED TO PREVENT DAMAGE AND TURNED OVER TO THE AIRPORT. ALL OTHER ITEMS SHALL BE DISPOSED OF OFF AIRPORT PROPERTY.
- THE PERIMETER OF THE REMOVAL LIMITS SHALL BE SAWCUT FULL DEPTH. DAMAGE TO PAVEMENT TO REMAIN SHALL BE REPAIRED AT THE CONTRACTOR'S EXPENSE.
- PAVEMENT REMOVED BEYOND THE LIMITS SHOWN TO FACILITATE THE CONTRACTOR'S OPERATIONS SHALL BE REPLACED AT HIS EXPENSE.
- LAHSO LIGHT INSTALLATION SHALL INCLUDE NEW LIGHT BASE CANS AND FOUNDATION, FIXTURES AND TRANSFORMERS, CONDUIT BETWEEN BASE CANS, CONNECTION OF NEW CONDUIT TO EXISTING CONDUIT, 2/C #8 5 KV UG CABLE FROM MANHOLE AT EDGE OF PAVEMENT TO FURTHEST FIXTURE, GROUND LUG, GROUND WIRE AND GROUND ROD.
- SEE "LAND AND HOLD SHORT OPERATION LIGHT INSTALLATION, L-850F" DETAIL ON ELECTRICAL DETAILS SHEET 2 FOR INSTALLATION REQUIREMENTS AT EACH LIGHT CAN.
- SEE "IN-PAVEMENT LIGHT INSTALLATION IN BITUMINOUS PAVEMENT" AND "LIGHT FIXTURE INSTALLATION" DETAILS ON ELECTRICAL DETAILS SHEET 2 FOR ADDITIONAL REQUIREMENTS.
- GROUND LUG, GROUND WIRE AND GROUND ROD ARE NOT SHOWN IN THE DETAIL TO IMPROVE CLARITY. A SEPARATE GROUND LUG, GROUND WIRE AND GROUND ROD IS REQUIRED INSIDE EACH BASE CAN.

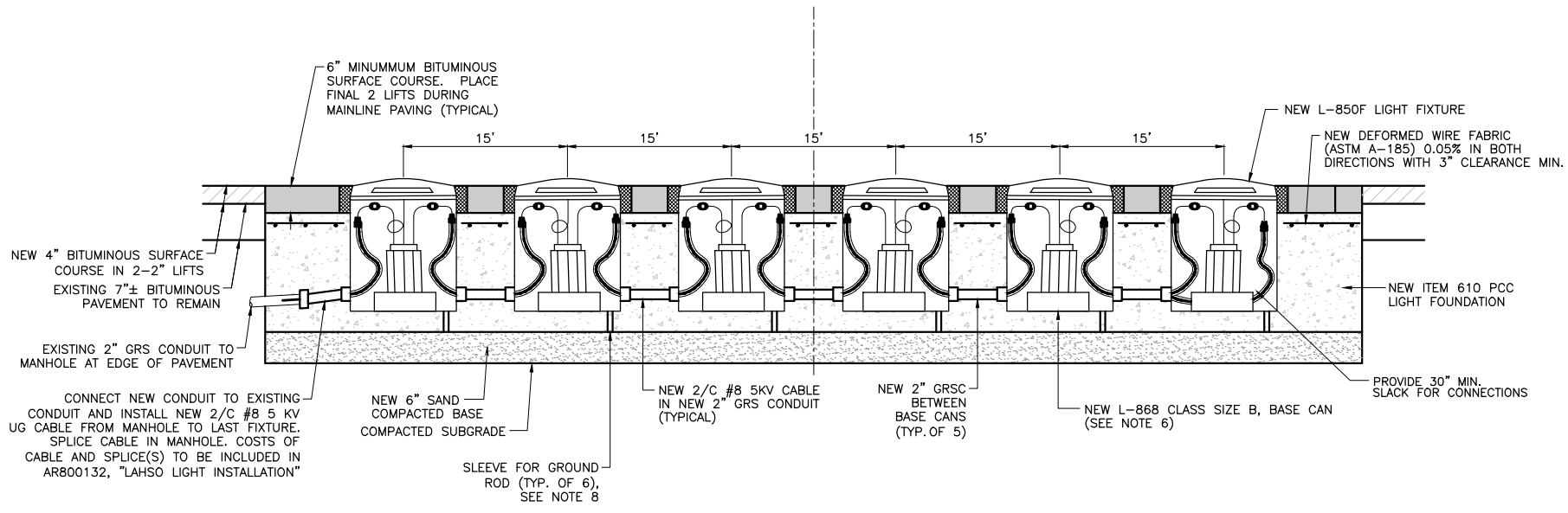

INSTALL LAHSO LIGHT FOUNDATION (AR800132)
NOT TO SCALE

IL. CONTRACT: **PA059**
 IL. LETTING ITEM: **18A**
 IL. PROJECT: **PWK-4414**
 S.B.G. PROJECT: **3-17-SBGP-XX**

SURVEY BOOK # 1302

REVISIONS		
NUMBER	BY	DATE

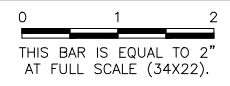

CHICAGO EXECUTIVE AIRPORT
WHEELING/PROSPECT HEIGHTS, ILLINOIS
REHABILITATE RUNWAY 16/34
ELECTRICAL DETAILS
SHEET 3

© Copyright CMT, Inc.
CMT
 CRAWFORD MURPHY & TILLY, INC.
 CONSULTING ENGINEERS
 License No. 184-000613

DESIGN BY:	SMS
DRAWN BY:	JRO
CHECKED BY:	SMS
APPROVED BY:	DKP
DATE:	06/19/2015
JOB No:	14290-05-00

FINAL

DATE: Thursday, July 9, 2015, 09:52:00
 FILE: K:\Chicago\Rehab\14290-05-RehabRW16-34\Draw\Sheets\68-GROOVING PLAN.dwg
 UPDATE BY: Sean Smith
 LAYOUT: GROOVING
 IMAGE FILES: pwknewLOGO_CEA-4-Color-Small (2).jpg
 REF DWG: bchm1 runway.dwg
 runway 16-34 base-NEW.dwg

IL. CONTRACT: PA059
 IL. LETTING ITEM: 18A
 IL. PROJECT: PWK-4414
 S.B.G. PROJECT: 3-17-SBGP-XX

SURVEY BOOK # 1302

REVISIONS		
NUMBER	BY	DATE

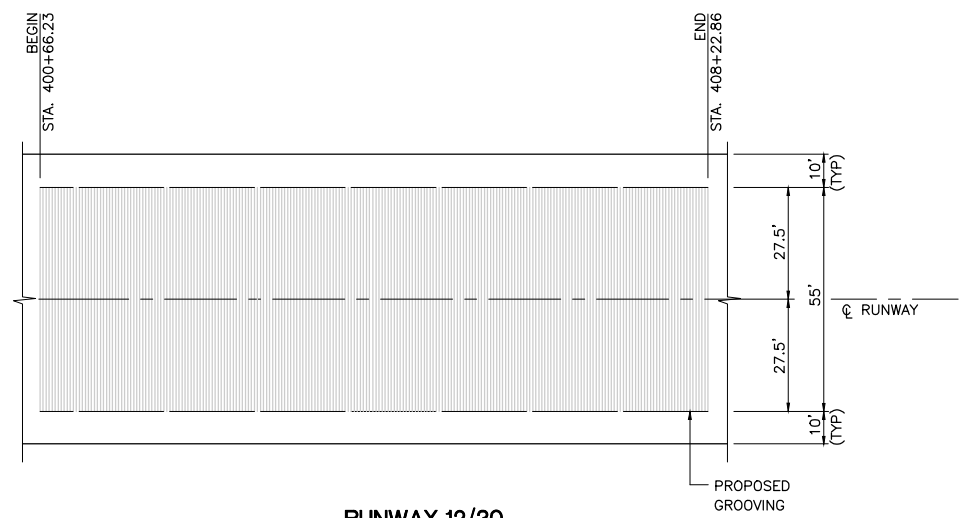
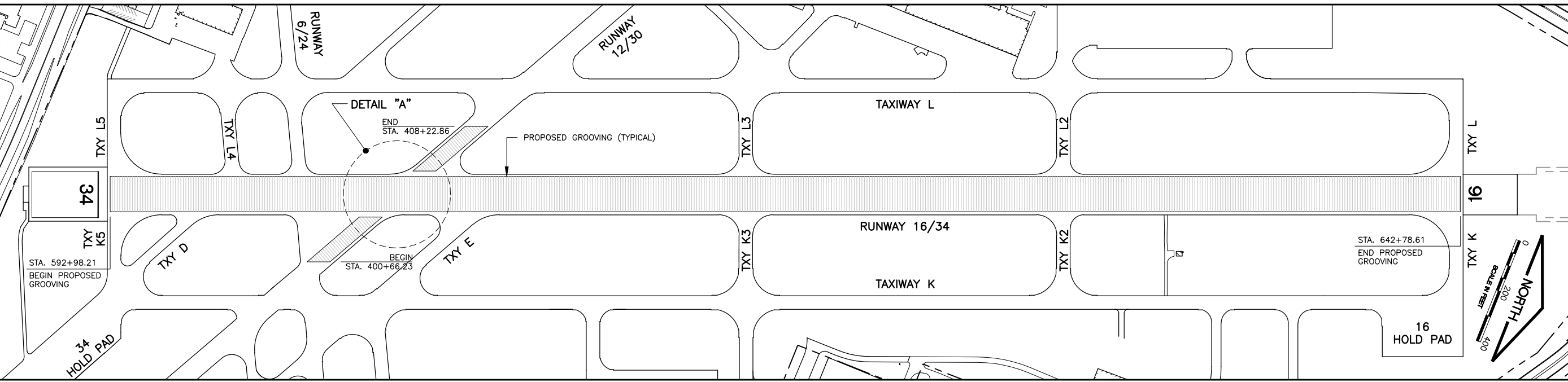
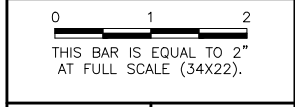

**RUNWAY 12/30
 PLAN VIEW**
 NO SCALE

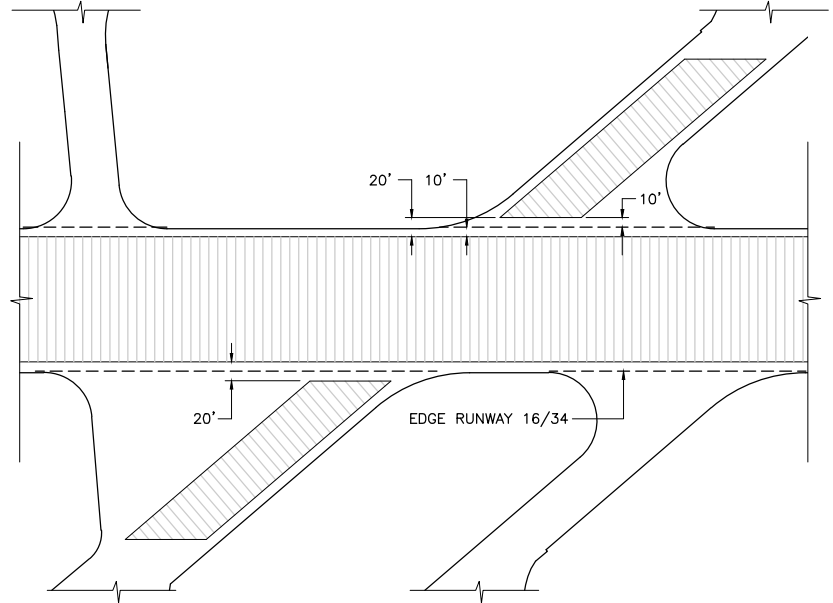

DETAIL "A"
 NO SCALE

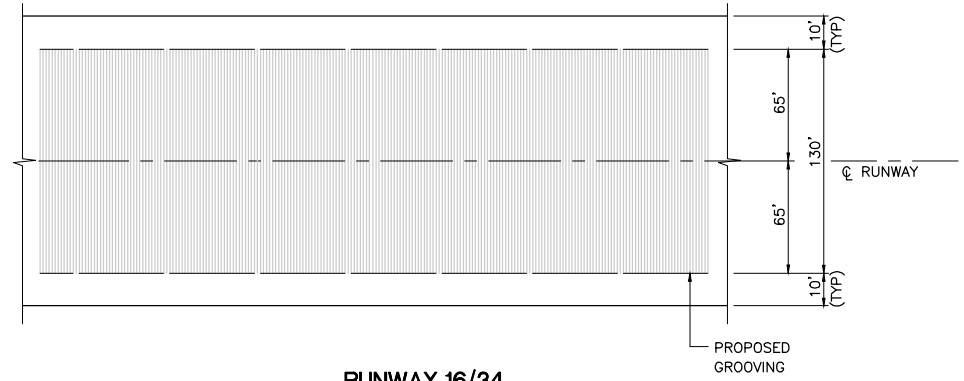

**RUNWAY 16/34
 PLAN VIEW**
 NO SCALE

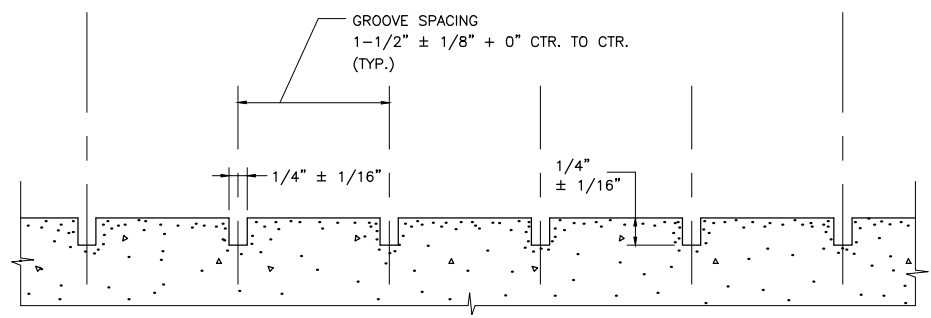

GROOVE DIMENSIONS
 NO SCALE

GROOVING NOTES

- GROOVING SHALL EXTEND OUTWARD 65' FROM CENTERLINE OF RUNWAY 16/34.
- SUCCESSIVE PASSES OF GROOVING MACHINE SHALL NOT OVERLAP.
- EXTREME CARE SHALL BE TAKEN WHEN GROOVING NEAR IN-PAVEMENT LIGHT FIXTURES AND SUBSURFACE WIRING. GROOVES SHALL BE SAWED NO CLOSER THAN 6" AND NO MORE THAN 18" TO SUCH FACILITIES.
- CLEANUP OF WASTE MATERIAL SHALL BE CONTINUOUS AND TIMELY DURING THE GROOVING OPERATION. WASTE MATERIAL SHALL BE DISPOSED OF OFF AIRPORT PROPERTY.
- GROOVING SHALL EXTEND OUTWARD 27.5' FROM CENTERLINE OF RUNWAY 12/30.

**CHICAGO EXECUTIVE AIRPORT
 WHEELING/PROSPECT HEIGHTS, ILLINOIS
 REHABILITATE RUNWAY 16/34**

GROOVING PLAN AND DETAILS

© Copyright CMT, Inc.

CMT
 CRAWFORD, MURPHY & TILLY, INC.
 CONSULTING ENGINEERS
 License No. 184-000613

CHICAGO EXECUTIVE AIRPORT

DESIGN BY:	MH
DRAWN BY:	JRO
CHECKED BY:	SMS
APPROVED BY:	DKP
DATE:	06/19/2015
JOB No:	14290-05-00

FINAL

SHEET 58 OF 58 SHEETS