

F.A.I. RTE.	SECTION	COUNTY	TOTAL SHEETS	SHEET NO.
57	D5 PATCHING 2009-4	DOUGLAS	14	1
FED. ROAD DIST. NO.	ILLINOIS	CONTRACT NO. 70741		

STATE OF ILLINOIS
DEPARTMENT OF TRANSPORTATION
DIVISION OF HIGHWAYS
**PROPOSED
HIGHWAY PLANS**
F.A.I. ROUTE 57 (I-57)
SECTION D5 PATCHING 2009-4
DOUGLAS COUNTY

FOR INDEX OF SHEETS, SEE SHEET NO. 2
FOR SUMMARY OF QUANTITIES, SEE SHEET NO. 4

C-95-030-08
TYPE OF IMPROVEMENT
PATCHING FROM COLES COUNTY LINE TO CHAMPAIGN COUNTY LINE
NORTHBOUND LANES ONLY

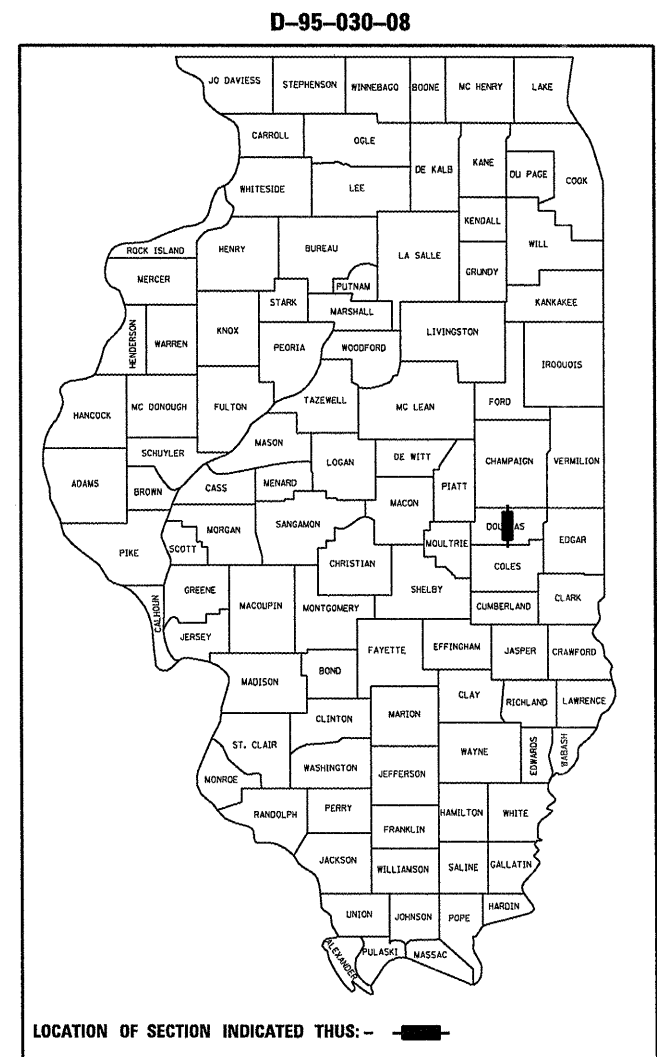

CURRENT TRAFFIC DATA
ADT = 18,000 (2007) I-57 SOUTH OF IL 133
ADT = 19,000 (2007) I-57 NORTH OF IL 133
ADT = 20,500 (2007) I-57 NORTH OF US 36

DESIGN DESIGNATION
NA

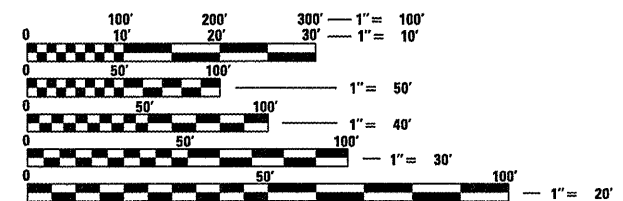

FULL SIZE PLANS HAVE BEEN PREPARED USING STANDARD ENGINEERING SCALES. REDUCED SIZED PLANS WILL NOT CONFORM TO STANDARD SCALES. IN MAKING MEASUREMENTS ON REDUCED PLANS, THE ABOVE SCALES MAY BE USED.

J.U.L.I.E.
JOINT UTILITY LOCATION INFORMATION FOR EXCAVATION
1-800-892-0123
OR 811

PROJECT ENGINEER: NANCY FASIG
SQUAD LEADER: CORY SHEEHY
DESIGNER: KARY DAWSON
PHONE: (217)465-4181
CONTRACT NO. 70741

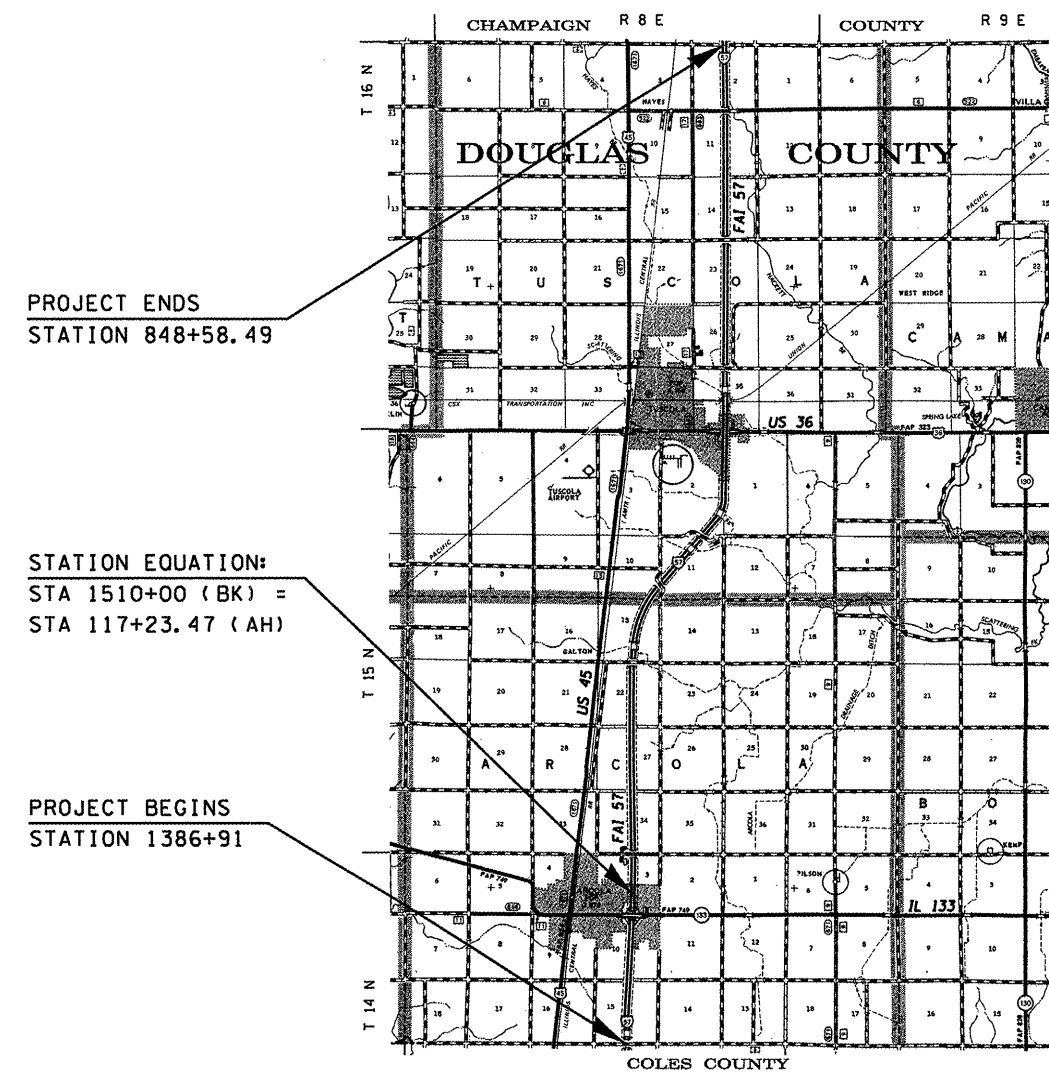

PROJECT ENDS
STATION 848+58.49

STATION EQUATION:
STA 1510+00 (BK) =
STA 117+23.47 (AH)

PROJECT BEGINS
STATION 1386+91

TOTAL LENGTH OF SECTION = 85,444.02 FEET = 16.183 MILES
NET LENGTH OF SECTION = 85,444.02 FEET = 16.183 MILES

STATE OF ILLINOIS
DEPARTMENT OF TRANSPORTATION
DIVISION OF HIGHWAYS

SUBMITTED 5/15 20 08
Joseph E. Gowen
DEPUTY DIRECTOR OF HIGHWAYS, REGION THREE ENGINEER

June 27, 20 08
Eric E. Harn
ENGINEER OF DESIGN AND ENVIRONMENT

June 27, 20 08
Christine M. Reed
DIRECTOR OF HIGHWAYS, CHIEF ENGINEER

**PRINTED BY THE AUTHORITY
OF THE STATE OF ILLINOIS**

PLOT DATE = 5/15/2008
FILE NAME = c:\projects\45707\1\diffpatch\20094.dgn
PLOT SCALE = 106.0000 / IN.
USER NAME = philipj

INDEX OF SHEETS

<u>SHEET NO.</u>	<u>DESCRIPTION</u>
1	COVER SHEET
2	INDEX OF SHEETS
2	LIST OF HIGHWAY STANDARDS
3	GENERAL NOTES
4	SUMMARY OF QUANTITIES
5-6	EXISTING TYPICAL SECTIONS
7-13	SCHEDULES OF QUANTITIES
14	DETAIL OF PAVEMENT MARKING (INTERSTATE & MULTI-LANE APPLICATIONS)

LIST OF HIGHWAY STANDARDS

<u>STANDARD NUMBER</u>	<u>NAME OF STANDARD</u>
000001-05	STANDARD SYMBOLS, ABBREVIATIONS AND PATTERNS
001001-01	AREAS OF REINFORCEMENT BARS
001006	DECIMAL OF AN INCH AND OF A FOOT
420001-07	PAVEMENT JOINTS
420401-06	BRIDGE APPROACH PAVEMENT
421001-02	BAR REINFORCEMENT FOR CRC PAVEMENT
421201-06	24' (7.2m) CRC PAVEMENT (WITH LUG SYSTEM)
442001-04	CLASS A PATCHES
701101-01	OFF-ROAD OPERATIONS, MULTILANE, 15' TO 24" FROM PAVEMENT EDGE
701400-02	APPROACH TO LANE CLOSURE, FREEWAY/EXPRESSWAY
701401-04	LANE CLOSURE, FREEWAY/EXPRESSWAY
701411-04	LANE CLOSURE, MULTILANE, AT ENTRANCE OR EXIT RAMP, FOR SPEEDS ≥ 45 MPH
701426-02	LANE CLOSURE, MULTILANE, INTERMITTENT OR MOVING OPERATION, FOR SPEEDS ≥ 45 MPH
701901	TRAFFIC CONTROL DEVICES
780001-01	TYPICAL PAVEMENT MARKINGS

FILE NAME = c:\projects\570741\5patch20094.dgn	USER NAME = sheehycm	DESIGNED - K. DAWSON	REVISED -
		DRAWN - J. PHILLIPS	REVISED -
	PLOT SCALE = 100.0000 ' / IN.	CHECKED -	REVISED -
	PLOT DATE = 5/15/2008	DATE - 05/2008	REVISED -

**STATE OF ILLINOIS
DEPARTMENT OF TRANSPORTATION**

INDEX OF SHEETS AND LIST OF HIGHWAY STANDARDS

SCALE: NA SHEET NO. 1 OF 1 SHEETS STA. TO STA.

F.A.I. RTE.	SECTION	COUNTY	TOTAL SHEETS	SHEET NO.
57	D5 PATCHING 2009-4	DOUGLAS	14	2
CONTRACT NO. 70741				
FED. ROAD DIST. NO. ILLINOIS FED. AID PROJECT				

GENERAL NOTES

G. N. -100
 ENGLISH UNITS OF MEASUREMENT SHALL GOVERN OVER AND
 SUPERSEDE ANY METRIC UNITS SHOWN IN THIS CONTRACT.
 WHERE INCLUDED, METRIC UNITS ARE FOR INFORMATION ONLY.

G. N. -442B -- PATCHING SCHEDULES
 THE PATCHING SCHEDULES INCLUDED IN THE PLANS
 REPRESENT THE BEST INFORMATION AVAILABLE AT THE
 TIME OF COMPLETION OF THE PLANS FOR LETTING.
 VARIATIONS IN LOCATION AND SIZES OF BOTH FULL-DEPTH
 AND PARTIAL-DEPTH PATCHES MAY OCCUR.

G. N. -780 SPECIAL
 PAINT PAVEMENT MARKINGS SHALL BE APPLIED UPON COMPLETION
 OF THE PATCH WORK. PAINT PAVEMENT MARKINGS SHALL COINCIDE
 WITH THE EXISTING PAVEMENT MARKINGS. PAINT PAVEMENT MARKINGS
 SHALL BE LIMITED TO ONLY LENGTH SEGMENTS ASSOCIATED WITH
 INDIVIDUAL PATCH LOCATIONS AND SHALL NOT BE APPLIED CONTINUOUSLY
 THROUGH THE PROJECT BETWEEN PATCH LOCATIONS.

ESTIMATED QUANTITIES:

73.0 FOOT CENTERLINE WHITE SKIP DASH - LINE 4"
 1,294.0 FOOT EDGE OF PAVEMENT WHITE SOLID - LINE 4"

NO COMMITMENTS

FILE NAME : c:\projects\4570741\45patch20094.dgn	USER NAME = sheehygm	DESIGNED - K. DAWSON	REVISED -	STATE OF ILLINOIS DEPARTMENT OF TRANSPORTATION	GENERAL NOTES	F.A.I. RTE. 57	SECTION D5 PATCHING 2009-4	COUNTY DOUGLAS	TOTAL SHEETS 14	SHEET NO. 3
PLOT SCALE = 100.0000' / IN.	CHECKED -	REVISED -	REVISED -	SCALE: NA	SHEET NO. 1 OF 1 SHEETS	STA.	TO STA.	CONTRACT NO. 70741		
PLOT DATE = 5/15/2008	DATE - 05/2008	REVISED -	REVISED -	FED. ROAD DIST. NO. ILLINOIS FED. AID PROJECT						

SUMMARY OF QUANTITIES

LOCATION OF WORK: NB FAI - 57
Douglas County

Sta. 1386+91.00 to 848+58.49

Rural - Multilane
100% State

CONSTRUCTION TYPE CODE: J000-2A

<u>CODE NO</u>	<u>ITEM</u>	<u>UNIT</u>	<u>TOTAL QUANTITY</u>
44200549	CLASS A PATCHES, TYPE I, 10 INCH	SQ YD	176.0
44200553	CLASS A PATCHES, TYPE II, 10 INCH	SQ YD	328.0
44200561	CLASS A PATCHES, TYPE I, 11 INCH	SQ YD	296.0
44200565	CLASS A PATCHES, TYPE II, 11 INCH	SQ YD	155.0
44200573	CLASS A PATCHES, TYPE I, 12 INCH	SQ YD	8.0
44200577	CLASS A PATCHES, TYPE II, 12 INCH	SQ YD	70.0
44213000	PATCHING REINFORCEMENT	SQ YD	1,032.0
44213200	SAW CUTS	FOOT	8,156.0
67100100	MOBILIZATION	L SUM	1.0
70100420	TRAFFIC CONTROL AND PROTECTION, STANDARD 701411	EACH	2.0
70100800	TRAFFIC CONTROL AND PROTECTION, STANDARD 701401	L SUM	1.0
70103815	TRAFFIC CONTROL SURVEILLANCE	CAL DA	10.0
* 78001110	PAINT PAVEMENT MARKING-LINE 4"	FOOT	1,367.0
X7015005	CHANGEABLE MESSAGE SIGN	CAL DA	28.0
Z0075300	TIE BARS	EACH	10.0

* SPECIALTY ITEM

FILE NAME : c:\projects\d570741\d5patch20094.dgn	USER NAME : sheehycm	DESIGNED - K. DAWSON	REVISED -	STATE OF ILLINOIS DEPARTMENT OF TRANSPORTATION	SUMMARY OF QUANTITIES	F.A.I. RTE. 57	SECTION D5 PATCHING 2009-4	COUNTY DOUGLAS	TOTAL SHEETS 14	SHEET NO. 4
		DRAWN - J. PHILLIPS	REVISED -							
		CHECKED -	REVISED -							
		DATE - 05/2008	REVISED -							
					SCALE: NA	SHEET NO. 1 OF 1 SHEETS	STA.	TO STA.	FED. ROAD DIST. NO. ILLINOIS FED. AID PROJECT CONTRACT NO. 70741	

EXISTING TYPICAL SECTION

STATION TO STATION
 1386+91.00 463+44.00 *
 524+70.00 547+01.25

* STATION EQUATIONS
 STA 1510+00.00 (BK) = STA 117+23.47 (AH)
 STA 360+83.33 (BK) = STA 360+87.35 (AH)

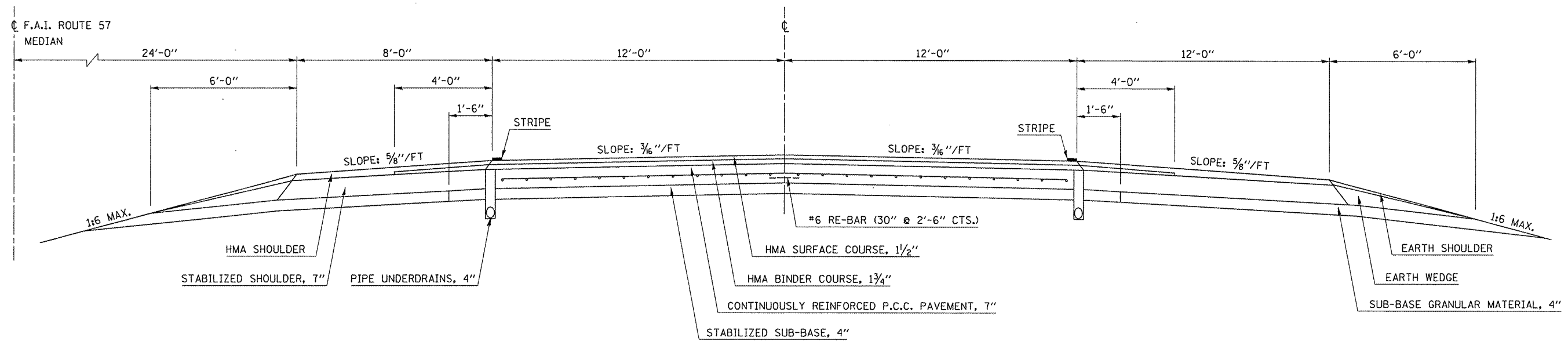

EXISTING TYPICAL SECTION

STATION TO STATION
 463+44.00 524+70.00

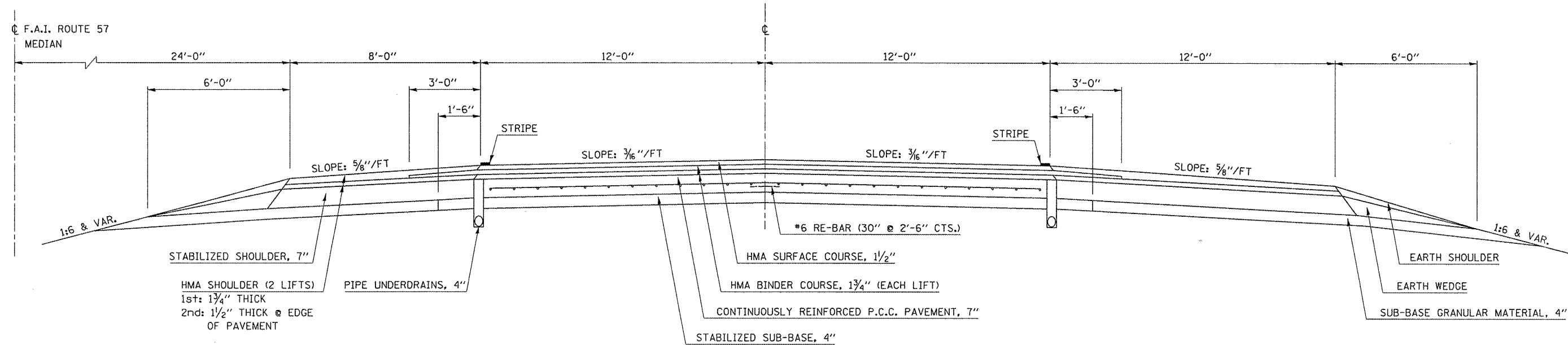

FILE NAME = c:\projects\570741\d5patch20094.dgn	USER NAME = sheehygm	DESIGNED - K. DAWSON	REVISED -	STATE OF ILLINOIS DEPARTMENT OF TRANSPORTATION	EXISTING TYPICAL SECTIONS		F.A.I. RTE. 57	SECTION D5 PATCHING 2009-4	COUNTY DOUGLAS	TOTAL SHEETS 14	SHEET NO. 5	
PLOT SCALE = 100.0000 / IN.	CHECKED -	DRAWN - J. PHILLIPS	REVISED -		SCALE: NA	SHEET NO. 1 OF 2 SHEETS	STA.	TO STA.	CONTRACT NO. 70741			
PLOT DATE = 5/15/2008	DATE - 05/2008	CHECKED -	REVISED -		FED. ROAD DIST. NO. ILLINOIS FED. AID PROJECT							
		DATE - 05/2008	REVISED -									

EXISTING TYPICAL SECTION

STATION 547+01.25 TO STATION 848+58.49 *

* STATION EQUATIONS

STA 575+43.68 (BK) = STA 575+43.98 (AH)
 STA 687+00.00 (BK) = STA 687+03.30 (AH)
 STA 736+24.61 (BK) = STA 736+26.44 (AH)
 STA 791+00.00 (BK) = STA 791+02.19 (AH)
 STA 843+84.01 (BK) = STA 843+83.95 (AH)

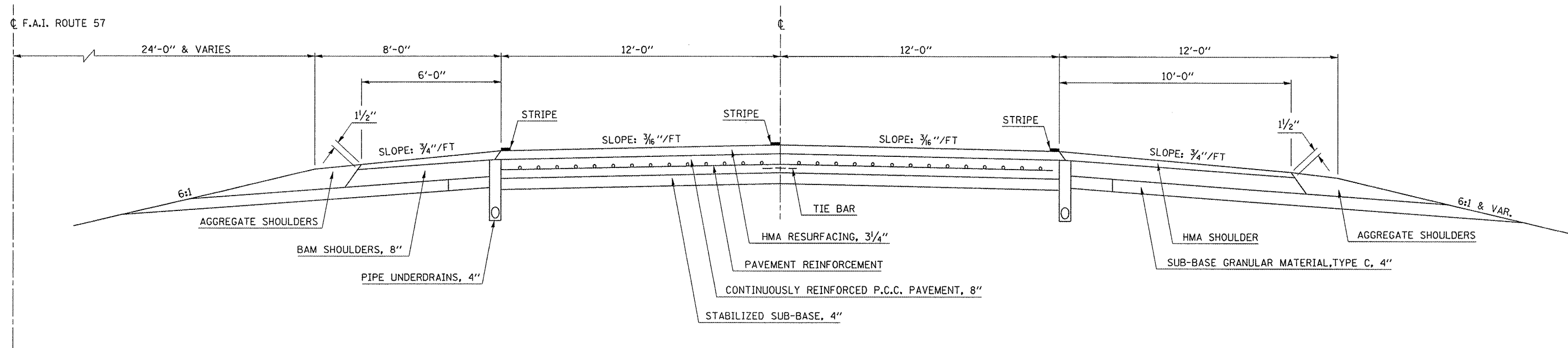

FILE NAME = c:\projects\0570741\d5patch2009.dgn	USER NAME = sheahygn	DESIGNED - K. DAWSON	REVISED -
		DRAWN - J. PHILLIPS	REVISED -
	PLOT SCALE = 100.0000' / IN.	CHECKED -	REVISED -
	PLOT DATE = 5/15/2008	DATE - 05/2008	REVISED -

STATE OF ILLINOIS
DEPARTMENT OF TRANSPORTATION

EXISTING TYPICAL SECTIONS

SCALE: NA SHEET NO. 2 OF 2 SHEETS STA. TO STA.

F.A.I. RTE.	SECTION	COUNTY	TOTAL SHEETS	SHEET NO.
57	D5 PATCHING 2009-4	DOUGLAS	14	6
FED. ROAD DIST. NO. ILLINOIS FED. AID PROJECT			CONTRACT NO. 70741	

SCHEDULE OF QUANTITIES

TABULATION OF CLASS A PATCHES, 10 INCH

STATION	DIRECTION	LANE	LENGTH (ft)	WIDTH (ft)	PATCH AREA		SAW CUTS 44213200 (ft)	TIE BARS Z0075300 (each)	PATCHING REINFORCEMENT 44213000 (sq. yd)
					TYPE I 10" (sq. yd)	TYPE II 10" (sq. yd)			
261+36.55	NORTHBOUND	DL	8	12	0.0	10.7	64.0	0	10.7
262+68.55	NORTHBOUND	DL	6	6	4.0	0.0	36.0	0	4.0
263+31.91	NORTHBOUND	DL	6	6	4.0	0.0	36.0	0	4.0
263+79.43	NORTHBOUND	DL	6	12	0.0	8.0	60.0	0	8.0
263+95.27	NORTHBOUND	DL	6	6	4.0	0.0	36.0	0	4.0
264+11.11	NORTHBOUND	DL	12	6	0.0	8.0	48.0	0	8.0
264+58.63	NORTHBOUND	DL	6	6	4.0	0.0	36.0	0	4.0
270+02.47	NORTHBOUND	DL	6	6	4.0	0.0	36.0	0	4.0
273+45.67	NORTHBOUND	DL	6	12	0.0	8.0	60.0	0	8.0
276+51.91	NORTHBOUND	DL	6	6	4.0	0.0	36.0	0	4.0
278+57.83	NORTHBOUND	DL	6	12	0.0	8.0	60.0	0	8.0
281+79.91	NORTHBOUND	DL	6	6	4.0	0.0	36.0	0	4.0
289+87.75	NORTHBOUND	DL	6	6	4.0	0.0	36.0	0	4.0
291+88.39	NORTHBOUND	DL	6	12	0.0	8.0	60.0	0	8.0
296+05.51	NORTHBOUND	DL	6	6	4.0	0.0	36.0	0	4.0
299+59.27	NORTHBOUND	DL	6	12	0.0	8.0	60.0	0	8.0
305+77.03	NORTHBOUND	DL	6	6	4.0	0.0	36.0	0	4.0
311+57.83	NORTHBOUND	DL	12	6	0.0	8.0	48.0	0	8.0
315+16.87	NORTHBOUND	DL	10	6	0.0	6.7	44.0	0	6.7
321+71.59	NORTHBOUND	DL	6	6	4.0	0.0	36.0	0	4.0
322+61.35	NORTHBOUND	DL	6	12	0.0	8.0	60.0	0	8.0
325+46.47	NORTHBOUND	DL	12	6	0.0	8.0	48.0	0	8.0
325+67.59	NORTHBOUND	DL	6	12	0.0	8.0	60.0	0	8.0
325+83.43	NORTHBOUND	DL	6	6	4.0	0.0	36.0	0	4.0
326+46.79	NORTHBOUND	DL	10	6	0.0	6.7	44.0	0	6.7
326+73.19	NORTHBOUND	DL	6	6	4.0	0.0	36.0	0	4.0
326+89.03	NORTHBOUND	DL	6	6	4.0	0.0	36.0	0	4.0
328+94.95	NORTHBOUND	DL	6	6	4.0	0.0	36.0	0	4.0
329+53.03	NORTHBOUND	DL	6	6	4.0	0.0	36.0	0	4.0
329+63.59	NORTHBOUND	DL	6	6	4.0	0.0	36.0	0	4.0
SHEET TOTALS					68.0 (sq. yd)	104.0 (sq. yd)	1328.0 (ft)	0.0 (each)	172.0 (sq. yd)

SCHEDULE OF QUANTITIES

TABULATION OF CLASS A PATCHES, 10 INCH

STATION	DIRECTION	LANE	LENGTH (ft)	WIDTH (ft)	PATCH AREA		SAW CUTS 44213200 (ft)	TIE BARS Z0075300 (each)	PATCHING REINFORCEMENT 44213000 (sq. yd)
					TYPE I 10" (sq. yd)	TYPE II 10" (sq. yd)			
331+48.39	NORTHBOUND	DL	10	6	0.0	6.7	44.0	0	6.7
335+17.99	NORTHBOUND	DL	6	6	4.0	0.0	36.0	0	4.0
344+10.31	NORTHBOUND	DL	12	6	0.0	8.0	48.0	0	8.0
344+36.71	NORTHBOUND	DL	12	6	0.0	8.0	48.0	0	8.0
345+21.19	NORTHBOUND	DL	6	12	0.0	8.0	60.0	0	8.0
373+19.59	NORTHBOUND	DL	6	12	0.0	8.0	60.0	0	8.0
379+53.19	NORTHBOUND	DL	6	6	4.0	0.0	36.0	0	4.0
383+33.35	NORTHBOUND	DL	10	6	0.0	6.7	44.0	0	6.7
386+18.47	NORTHBOUND	DL	6	12	0.0	8.0	60.0	0	8.0
389+35.27	NORTHBOUND	DL	6	12	0.0	8.0	60.0	0	8.0
390+88.39	NORTHBOUND	DL	10	6	0.0	6.7	44.0	0	6.7
395+10.79	NORTHBOUND	DL	6	12	0.0	8.0	60.0	0	8.0
401+97.19	NORTHBOUND	DL	6	6	4.0	0.0	36.0	0	4.0
402+71.11	NORTHBOUND	DL	10	6	0.0	6.7	44.0	0	6.7
404+08.39	NORTHBOUND	DL	6	12	0.0	8.0	60.0	0	8.0
404+18.95	NORTHBOUND	DL	6	6	4.0	0.0	36.0	0	4.0
405+24.55	NORTHBOUND	DL	10	6	0.0	6.7	44.0	0	6.7
405+98.47	NORTHBOUND	DL	6	12	0.0	8.0	60.0	0	8.0
406+61.83	NORTHBOUND	DL	6	6	4.0	0.0	36.0	0	4.0
407+99.11	NORTHBOUND	DL	6	6	4.0	0.0	36.0	0	4.0
408+41.35	NORTHBOUND	DL	6	6	4.0	0.0	36.0	0	4.0
410+26.15	NORTHBOUND	DL	6	6	4.0	0.0	36.0	0	4.0
412+95.43	NORTHBOUND	DL	6	6	4.0	0.0	36.0	0	4.0
413+85.19	NORTHBOUND	DL	6	6	4.0	0.0	36.0	0	4.0
415+80.55	NORTHBOUND	DL	6	6	4.0	0.0	36.0	0	4.0
418+60.39	NORTHBOUND	DL	6	6	4.0	0.0	36.0	0	4.0
419+81.83	NORTHBOUND	DL	6	6	4.0	0.0	36.0	0	4.0
420+24.07	NORTHBOUND	DL	6	6	4.0	0.0	36.0	0	4.0
421+19.11	NORTHBOUND	DL	6	6	4.0	0.0	36.0	0	4.0
421+24.39	NORTHBOUND	DL	6	12	0.0	8.0	60.0	0	8.0
SHEET TOTALS					60.0 (sq. yd)	113.3 (sq. yd)	1336.0 (ft)	0.0 (Each)	173.3 (sq. yd)

FILE NAME :
c:\projects\4570741\d5patch20094.dgn

USER NAME : shaehygm
PLOT SCALE : 100.0000' / IN.
PLOT DATE : 5/15/2008

DESIGNED - K. DAWSON
DRAWN - J. PHILLIPS
CHECKED -
DATE - 05/2008

REVISED -
REVISED -
REVISED -
REVISED -

**STATE OF ILLINOIS
DEPARTMENT OF TRANSPORTATION**

SCHEDULES OF QUANTITIES

SCALE: NA SHEET NO. 2 OF 7 SHEETS STA. TO STA.

F.A.I. RTE.	SECTION	COUNTY	TOTAL SHEETS	SHEET NO.
57	D5 PATCHING 2009-4	DOUGLAS	14	B
CONTRACT NO. 70741				
FED. ROAD DIST. NO. ILLINOIS FED. AID PROJECT				

SCHEDULE OF QUANTITIES

TABULATION OF CLASS A PATCHES, 10 INCH

STATION	DIRECTION	LANE	LENGTH (ft)	WIDTH (ft)	PATCH AREA		SAW CUTS 44213200 (ft)	TIE BARS Z0075300 (each)	PATCHING REINFORCEMENT 44213000 (sq. yd)
					TYPE I 10" (sq. yd)	TYPE II 10" (sq. yd)			
424+09.51	NORTHBOUND	DL	6	12	0.0	8.0	60.0	0	8.0
424+35.91	NORTHBOUND	DL	6	12	0.0	8.0	60.0	0	8.0
428+31.91	NORTHBOUND	DL	6	6	4.0	0.0	36.0	0	4.0
430+95.91	NORTHBOUND	DL	6	6	4.0	0.0	36.0	0	4.0
431+22.31	NORTHBOUND	DL	8	12	0.0	10.7	64.0	0	10.7
431+53.99	NORTHBOUND	DL	6	6	4.0	0.0	36.0	0	4.0
432+64.87	NORTHBOUND	DL	6	6	4.0	0.0	36.0	0	4.0
433+49.35	NORTHBOUND	DL	10	6	0.0	6.7	44.0	0	6.7
434+07.43	NORTHBOUND	DL	6	6	4.0	0.0	36.0	0	4.0
434+44.39	NORTHBOUND	DL	6	6	4.0	0.0	36.0	0	4.0
439+88.23	NORTHBOUND	DL	8	6	0.0	5.3	40.0	0	5.3
441+25.51	NORTHBOUND	DL	6	6	4.0	0.0	36.0	0	4.0
443+73.67	NORTHBOUND	DL	6	12	0.0	8.0	60.0	0	8.0
443+89.51	NORTHBOUND	DL	6	6	4.0	0.0	36.0	0	4.0
446+11.27	NORTHBOUND	DL	6	6	4.0	0.0	36.0	0	4.0
450+49.51	NORTHBOUND	DL	6	12	0.0	8.0	60.0	0	8.0
456+09.19	NORTHBOUND	DL	6	6	4.0	0.0	36.0	0	4.0
457+78.15	NORTHBOUND	DL	6	6	4.0	0.0	36.0	0	4.0
460+89.67	NORTHBOUND	DL	8	12	0.0	10.7	64.0	0	10.7
462+16.39	NORTHBOUND	DL	6	12	0.0	8.0	60.0	0	8.0
462+32.23	NORTHBOUND	DL	6	12	0.0	8.0	60.0	0	8.0
542+15.59	NORTHBOUND	DL	8	6	0.0	5.3	40.0	0	5.3
542+31.43	NORTHBOUND	DL	6	6	4.0	0.0	36.0	0	4.0
542+41.99	NORTHBOUND	DL	6	12	0.0	8.0	60.0	0	8.0
542+52.55	NORTHBOUND	DL	6	12	0.0	8.0	60.0	0	8.0
546+90.79	NORTHBOUND	DL	6	12	0.0	8.0	60.0	0	8.0
SHEET TOTALS					48.0 (sq. yd)	110.7 (sq. yd)	1224.0 (ft)	0.0 (each)	158.7 (sq. yd)

	PATCH AREA		SAW CUTS 44213200 (ft)	TIE BARS Z0075300 (each)	PATCHING REINFORCEMENT 44213000 (sq. yd)
	TYPE I 10" (sq. yd)	TYPE II 10" (sq. yd)			
SHEET 5 TOTALS	68.0	104.0	1328.0	0.0	172.0
SHEET 6 TOTALS	60.0	113.3	1336.0	0.0	173.3
SHEET 7 TOTALS	48.0	110.7	1224.0	0.0	158.7
CLASS A PATCHES, 10" FINAL TOTALS	176.0 (sq. yd)	328.0 (sq. yd)	3888.0 (ft)	0.0 (each)	504.0 (sq. yd)

SCHEDULE OF QUANTITIES

TABULATION OF CLASS A PATCHES, 11 INCH

STATION	DIRECTION	LANE	LENGTH (ft)	WIDTH (ft)	PATCH AREA		SAW CUTS 44213200 (ft)	TIE BARS Z0075300 (each)	PATCHING REINFORCEMENT 44213000 (sq. yd)
					TYPE I 11" (sq. yd)	TYPE II 11" (sq. yd)			
547+06.63	NORTHBOUND	DL	6	6	4.0	0.0	36.0	0	4.0
547+27.75	NORTHBOUND	DL	12	6	0.0	8.0	48.0	0	8.0
547+54.15	NORTHBOUND	DL	6	12	0.0	8.0	60.0	0	8.0
549+12.55	NORTHBOUND	DL	6	6	4.0	0.0	36.0	0	4.0
553+56.07	NORTHBOUND	DL	6	12	0.0	8.0	60.0	0	8.0
559+21.03	NORTHBOUND	DL	6	6	4.0	0.0	36.0	0	4.0
559+42.15	NORTHBOUND	DL	12	6	0.0	8.0	48.0	0	8.0
560+05.51	NORTHBOUND	DL	8	12	0.0	10.7	64.0	0	10.7
563+48.71	NORTHBOUND	DL	6	6	4.0	0.0	36.0	0	4.0
563+53.99	NORTHBOUND	DL	6	12	0.0	8.0	60.0	0	8.0
570+56.23	NORTHBOUND	DL	6	6	4.0	0.0	36.0	0	4.0
570+98.47	NORTHBOUND	DL	6	6	4.0	0.0	36.0	0	4.0
572+14.63	NORTHBOUND	DL	6	6	4.0	0.0	36.0	0	4.0
578+32.39	NORTHBOUND	DL	6	12	0.0	8.0	60.0	0	8.0
582+01.99	NORTHBOUND	DL	6	6	4.0	0.0	36.0	0	4.0
582+28.39	NORTHBOUND	DL	6	6	4.0	0.0	36.0	0	4.0
582+70.63	NORTHBOUND	DL	6	6	4.0	0.0	36.0	0	4.0
584+29.03	NORTHBOUND	DL	6	6	4.0	0.0	36.0	0	4.0
584+71.27	NORTHBOUND	DL	6	6	4.0	0.0	36.0	0	4.0
586+34.95	NORTHBOUND	DL	6	6	4.0	0.0	36.0	0	4.0
647+12.23	NORTHBOUND	DL	6	6	4.0	0.0	36.0	0	4.0
647+86.15	NORTHBOUND	DL	6	6	4.0	0.0	36.0	0	4.0
648+12.55	NORTHBOUND	DL	6	6	4.0	0.0	36.0	0	4.0
654+56.71	NORTHBOUND	DL	6	6	4.0	0.0	36.0	0	4.0
656+62.63	NORTHBOUND	DL	6	6	4.0	0.0	36.0	0	4.0
656+99.59	NORTHBOUND	DL	6	6	4.0	0.0	36.0	0	4.0
657+41.83	NORTHBOUND	DL	6	6	4.0	0.0	36.0	0	4.0
658+31.59	NORTHBOUND	DL	6	6	4.0	0.0	36.0	0	4.0
660+63.91	NORTHBOUND	DL	6	6	4.0	0.0	36.0	0	4.0
661+32.55	NORTHBOUND	DL	20	6	0.0	13.3	64.0	10	13.3
SHEET TOTALS					88.0 (sq. yd)	72.0 (sq. yd)	1256.0 (ft)	10.0 (each)	160.0 (sq. yd)

SCHEDULE OF QUANTITIES

TABULATION OF CLASS A PATCHES, 11 INCH

STATION	DIRECTION	LANE	LENGTH (ft)	WIDTH (ft)	PATCH AREA		SAW CUTS 44213200 (ft)	TIE BARS Z0075300 (each)	PATCHING REINFORCEMENT 44213000 (sq. yd)
					TYPE I 11" (sq. yd)	TYPE II 11" (sq. yd)			
662+80.39	NORTHBOUND	DL	6	6	4.0	0.0	36.0	0	4.0
663+64.87	NORTHBOUND	DL	10	6	0.0	6.7	44.0	0	6.7
665+60.23	NORTHBOUND	DL	6	6	4.0	0.0	36.0	0	4.0
666+28.87	NORTHBOUND	DL	6	6	4.0	0.0	36.0	0	4.0
666+55.27	NORTHBOUND	DL	6	6	4.0	0.0	36.0	0	4.0
666+81.67	NORTHBOUND	DL	6	6	4.0	0.0	36.0	0	4.0
669+29.83	NORTHBOUND	DL	6	6	4.0	0.0	36.0	0	4.0
669+56.23	NORTHBOUND	DL	6	6	4.0	0.0	36.0	0	4.0
671+67.43	NORTHBOUND	DL	6	6	4.0	0.0	36.0	0	4.0
674+57.83	NORTHBOUND	DL	6	6	4.0	0.0	36.0	0	4.0
675+89.83	NORTHBOUND	DL	6	6	4.0	0.0	36.0	0	4.0
686+93.35	NORTHBOUND	DL	6	12	0.0	8.0	60.0	0	8.0
687+61.99	NORTHBOUND	DL	12	6	0.0	8.0	48.0	0	8.0
688+46.47	NORTHBOUND	DL	6	6	4.0	0.0	36.0	0	4.0
688+57.03	NORTHBOUND	DL	12	6	0.0	8.0	48.0	0	8.0
688+67.59	NORTHBOUND	DL	12	6	0.0	8.0	48.0	0	8.0
688+99.27	NORTHBOUND	DL	10	6	0.0	6.7	44.0	0	6.7
691+05.19	NORTHBOUND	DL	6	6	4.0	0.0	36.0	0	4.0
691+26.31	NORTHBOUND	DL	6	6	4.0	0.0	36.0	0	4.0
692+42.47	NORTHBOUND	DL	6	6	4.0	0.0	36.0	0	4.0
697+65.19	NORTHBOUND	DL	6	6	4.0	0.0	36.0	0	4.0
698+07.43	NORTHBOUND	DL	6	6	4.0	0.0	36.0	0	4.0
698+23.27	NORTHBOUND	DL	6	6	4.0	0.0	36.0	0	4.0
698+44.39	NORTHBOUND	DL	10	6	0.0	6.7	44.0	0	6.7
709+63.75	NORTHBOUND	DL	6	6	4.0	0.0	36.0	0	4.0
709+95.43	NORTHBOUND	DL	6	6	4.0	0.0	36.0	0	4.0
718+98.31	NORTHBOUND	DL	6	6	4.0	0.0	36.0	0	4.0
727+00.87	NORTHBOUND	DL	6	6	4.0	0.0	36.0	0	4.0
727+21.99	NORTHBOUND	DL	6	6	4.0	0.0	36.0	0	4.0
728+11.75	NORTHBOUND	DL	6	6	4.0	0.0	36.0	0	4.0
SHEET TOTALS					92.0 (sq. yd)	52.0 (sq. yd)	1164.0 (ft)	0.0 (Each)	144.0 (sq. yd)

SCHEDULE OF QUANTITIES

TABULATION OF CLASS A PATCHES, 11 INCH

STATION	DIRECTION	LANE	LENGTH (ft)	WIDTH (ft)	PATCH AREA		SAW CUTS 44213200 (ft)	TIE BARS Z0075300 (each)	PATCHING REINFORCEMENT 44213000 (sq. yd)
					TYPE I 11" (sq. yd)	TYPE II 11" (sq. yd)			
728+75.11	NORTHBOUND	DL	6	6	4.0	0.0	36.0	0	4.0
728+80.39	NORTHBOUND	DL	6	6	4.0	0.0	36.0	0	4.0
728+90.95	NORTHBOUND	DL	6	6	4.0	0.0	36.0	0	4.0
728+96.23	NORTHBOUND	DL	6	6	4.0	0.0	36.0	0	4.0
729+33.19	NORTHBOUND	DL	6	6	4.0	0.0	36.0	0	4.0
729+80.71	NORTHBOUND	DL	6	6	4.0	0.0	36.0	0	4.0
730+33.51	NORTHBOUND	DL	8	6	0.0	5.3	40.0	0	5.3
733+34.47	NORTHBOUND	DL	6	6	4.0	0.0	36.0	0	4.0
733+45.03	NORTHBOUND	DL	6	6	4.0	0.0	36.0	0	4.0
733+71.43	NORTHBOUND	DL	6	6	4.0	0.0	36.0	0	4.0
733+87.27	NORTHBOUND	DL	10	6	0.0	6.7	44.0	0	6.7
734+61.19	NORTHBOUND	DL	6	6	4.0	0.0	36.0	0	4.0
736+14.31	NORTHBOUND	DL	6	6	4.0	0.0	36.0	0	4.0
741+42.31	NORTHBOUND	DL	6	6	4.0	0.0	36.0	0	4.0
741+95.11	NORTHBOUND	DL	6	6	4.0	0.0	36.0	0	4.0
742+21.51	NORTHBOUND	DL	6	6	4.0	0.0	36.0	0	4.0
743+74.63	NORTHBOUND	DL	8	6	0.0	5.3	40.0	0	5.3
745+85.83	NORTHBOUND	DL	6	6	4.0	0.0	36.0	0	4.0
746+43.91	NORTHBOUND	DL	10	6	0.0	6.7	44.0	0	6.7
747+07.27	NORTHBOUND	DL	6	6	4.0	0.0	36.0	0	4.0
748+70.95	NORTHBOUND	DL	6	6	4.0	0.0	36.0	0	4.0
748+92.07	NORTHBOUND	DL	6	6	4.0	0.0	36.0	0	4.0
752+35.27	NORTHBOUND	DL	6	6	4.0	0.0	36.0	0	4.0
752+77.51	NORTHBOUND	DL	6	6	4.0	0.0	36.0	0	4.0
754+88.71	NORTHBOUND	DL	6	6	4.0	0.0	36.0	0	4.0
756+36.55	NORTHBOUND	DL	10	6	0.0	6.7	44.0	0	6.7
756+52.39	NORTHBOUND	DL	6	6	4.0	0.0	36.0	0	4.0
756+84.07	NORTHBOUND	DL	6	6	4.0	0.0	36.0	0	4.0
759+32.23	NORTHBOUND	DL	6	6	4.0	0.0	36.0	0	4.0
761+01.19	NORTHBOUND	DL	6	6	4.0	0.0	36.0	0	4.0
SHEET TOTALS					100.0 (sq. yd)	30.7 (sq. yd)	1112.0 (ft)	0.0 (each)	130.7 (sq. yd)

SCHEDULE OF QUANTITIES

TABULATION OF CLASS A PATCHES, 11 INCH

STATION	DIRECTION	LANE	LENGTH (ft)	WIDTH (ft)	PATCH AREA		SAW CUTS 44213200 (ft)	TIE BARS Z0075300 (each)	PATCHING REINFORCEMENT 44213000 (sq. yd)
					TYPE I 11" (sq. yd)	TYPE II 11" (sq. yd)			
765+13.03	NORTHBOUND	DL	6	6	4.0	0.0	36.0	0	4.0
765+28.87	NORTHBOUND	DL	6	6	4.0	0.0	36.0	0	4.0
765+92.23	NORTHBOUND	DL	6	6	4.0	0.0	36.0	0	4.0
766+18.63	NORTHBOUND	DL	6	6	4.0	0.0	36.0	0	4.0
SHEET TOTALS					16.0 (sq. yd)	0.0 (sq. yd)	144.0 (ft)	0.0 (each)	16.0 (sq. yd)

11 INCH SUMMARY

	PATCH AREA		SAW CUTS 44213200 (ft)	TIE BARS Z0075300 (each)	PATCHING REINFORCEMENT 44213000 (sq. yd)
	TYPE I 11" (sq. yd)	TYPE II 11" (sq. yd)			
SHEET 8 TOTALS	88.0	72.0	1256.0	10.0	160.0
SHEET 9 TOTALS	92.0	52.0	1164.0	0.0	144.0
SHEET 10 TOTALS	100.0	30.7	1112.0	0.0	130.7
SHEET 11 TOTALS	16.0	0.0	144.0	0.0	16.0
CLASS A PATCHES, 11" FINAL TOTALS	296.0 (sq. yd)	154.7 (sq. yd)	3676.0 (ft)	10.0 (each)	450.7 (sq. yd)

TABULATION OF CLASS A PATCHES, 12 INCH

STATION	DIRECTION	LANE	LENGTH (ft)	WIDTH (ft)	PATCH AREA		SAW CUTS 44213200 (ft)	TIE BARS Z0075300 (each)	PATCHING REINFORCEMENT 44213000 (sq. yd)
					TYPE I 12" (sq. yd)	TYPE II 12" (sq. yd)			
465+64.87	NORTHBOUND	DL	6	12	0.0	8.0	60.0	0	8.0
471+56.23	NORTHBOUND	DL	6	12	0.0	8.0	60.0	0	8.0
480+27.43	NORTHBOUND	DL	6	12	0.0	8.0	60.0	0	8.0
480+64.39	NORTHBOUND	DL	6	12	0.0	8.0	60.0	0	8.0
480+85.51	NORTHBOUND	DL	6	12	0.0	8.0	60.0	0	8.0
482+22.79	NORTHBOUND	DL	6	6	4.0	0.0	36.0	0	4.0
485+07.91	NORTHBOUND	DL	8	6	0.0	5.3	40.0	0	5.3
488+51.11	NORTHBOUND	DL	6	12	0.0	8.0	60.0	0	8.0
492+78.79	NORTHBOUND	DL	6	12	0.0	8.0	60.0	0	8.0
495+11.11	NORTHBOUND	DL	6	6	4.0	0.0	36.0	0	4.0
496+85.35	NORTHBOUND	DL	6	12	0.0	8.0	60.0	0	8.0
CLASS A PATCHES, 12" FINAL TOTALS					8.0 (sq. yd)	69.3 (sq. yd)	592.0 (ft)	0.0 (each)	77.3 (sq. yd)

CENTERLINE INTERSTATE OR MULTI-LANE TWO WAY DIVIDED HIGHWAY

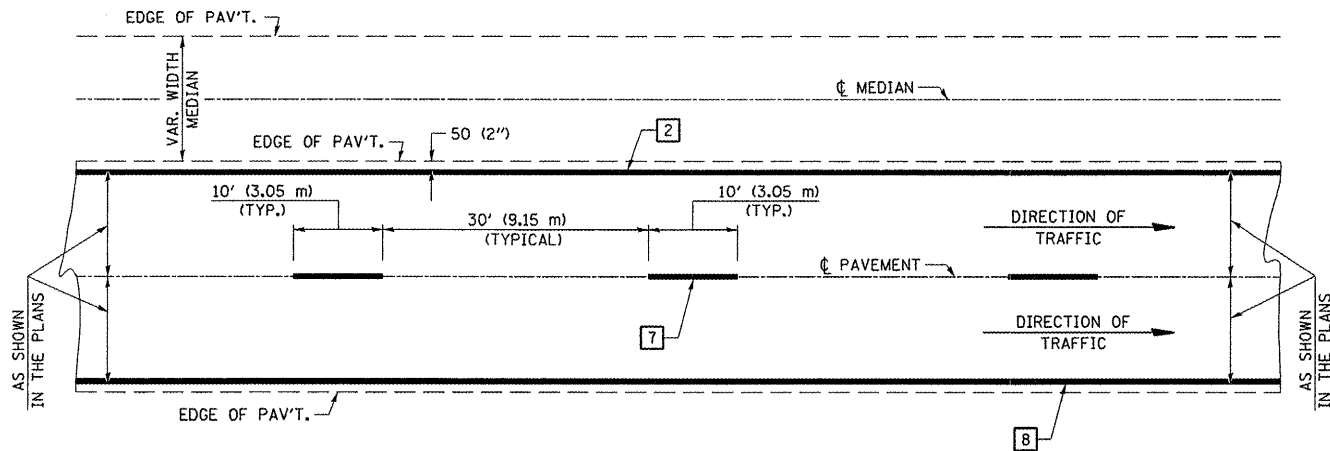

NOTE: PAVEMENT MARKINGS ARE TO BE EXTENDED THROUGH OMISSIONS WHEN APPLICABLE.

NOTE: SEE ARTICLES 780.04 & 781.03 FOR LOCATION OF STRIPES AND MARKERS RELATIVE TO EDGES OR JOINTS.
FOR RAISED REFLECTIVE PAVEMENT MARKERS, REFER TO STANDARD 781001.

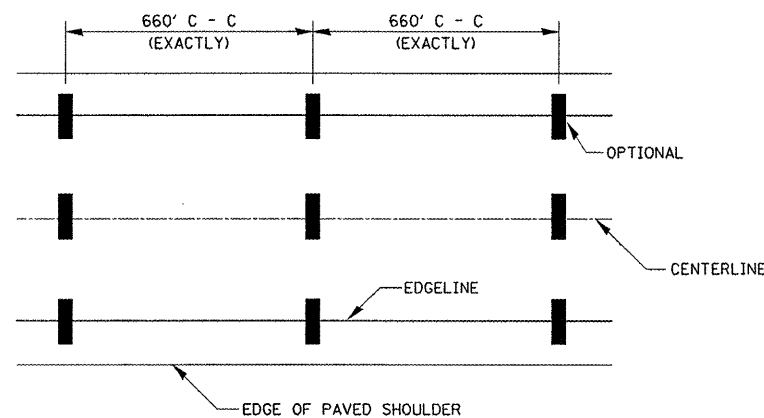
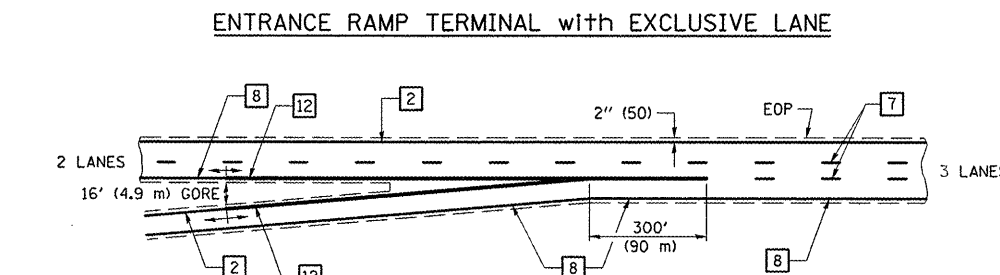
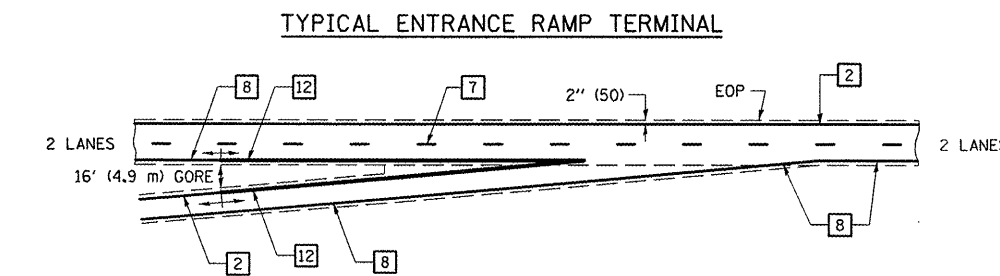
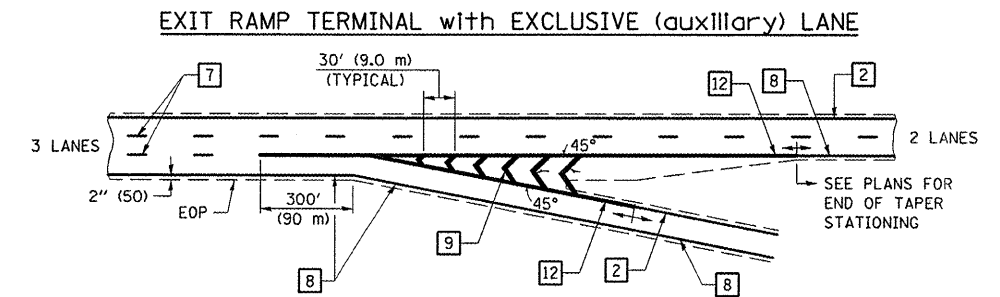
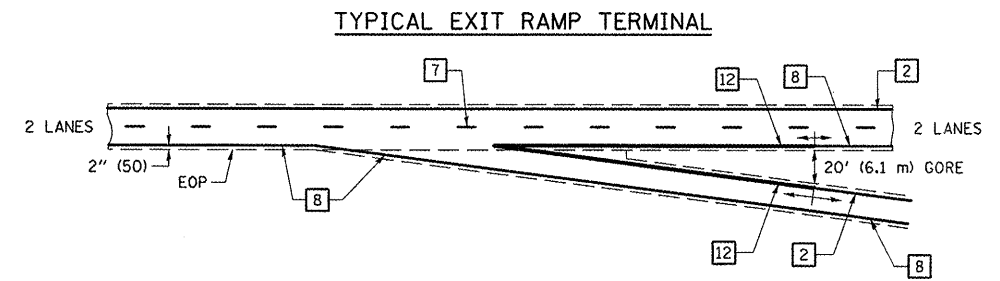

TYPICAL PAVEMENT MARKING LEGEND

- 1 4" (100) SKIP-DASH (YELLOW)
- 2 4" (100) SOLID (YELLOW)
- 3 12" (300) DIAGONAL (YELLOW)
- 4 4" (100) DOUBLE YELLOW (NARROW)
- 5 RESERVED
- 6 RESERVED
- 7 4" (100) SKIP-DASH (WHITE)
- 8 4" (100) SOLID (WHITE)
- 9 12" (300) DIAGONAL (WHITE)
- 10 6" (150) SOLID (WHITE)
- 11 24" (600) STOP BAR (WHITE)
- 12 8" (200) SOLID (WHITE)
- 13 4" (100) LANE LINE EXTENSIONS (WHITE)

IT WILL BE NECESSARY TO HAVE A REPRESENTATIVE OF THE STATE POLICE PRESENT SO THAT THE ACCURACY OF MEASUREMENT CAN BE ATTESTED TO IN COURT.

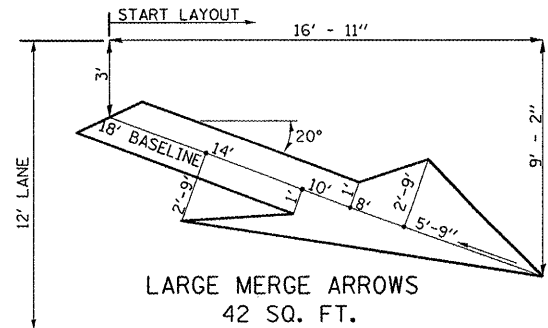
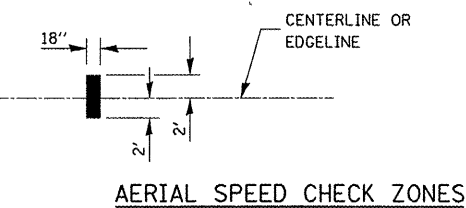

Note: All dimensions are in INCHES (millimeters) unless otherwise shown.

FILE NAME : c:\projects\0570741\d5patch20094.dgn	USER NAME : sheehygm	DESIGNED -	REVISED - 11/06
		DRAWN -	REVISED -
		CHECKED -	REVISED -
		DATE -	REVISED -

**STATE OF ILLINOIS
DEPARTMENT OF TRANSPORTATION**

PAVEMENT MARKING (INTERSTATE & MULTI-LANE APPLICATIONS)

SCALE: NA SHEET NO. 1 OF 1 SHEETS STA. TO STA.

DISTRICT 5 DETAIL NO. 7800BBBB			
F.A.I. RTE.	SECTION	COUNTY	TOTAL SHEETS NO.
57	D5 PATCHING 2009-4	DOUGLAS	14 14
			CONTRACT NO. 70741
FED. ROAD DIST. NO. ILLINOIS FED. AID PROJECT			