

STATE OF ILLINOIS
DEPARTMENT OF TRANSPORTATION

ROUTE NO.	SECTION	COUNTY	PROJECT	SHEET NO.
FAP 869	105BR-2	SALINE	118	60
23 SHEETS				

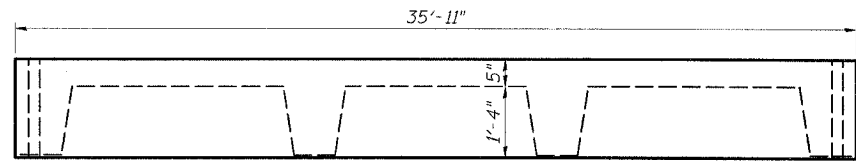

ELEVATION

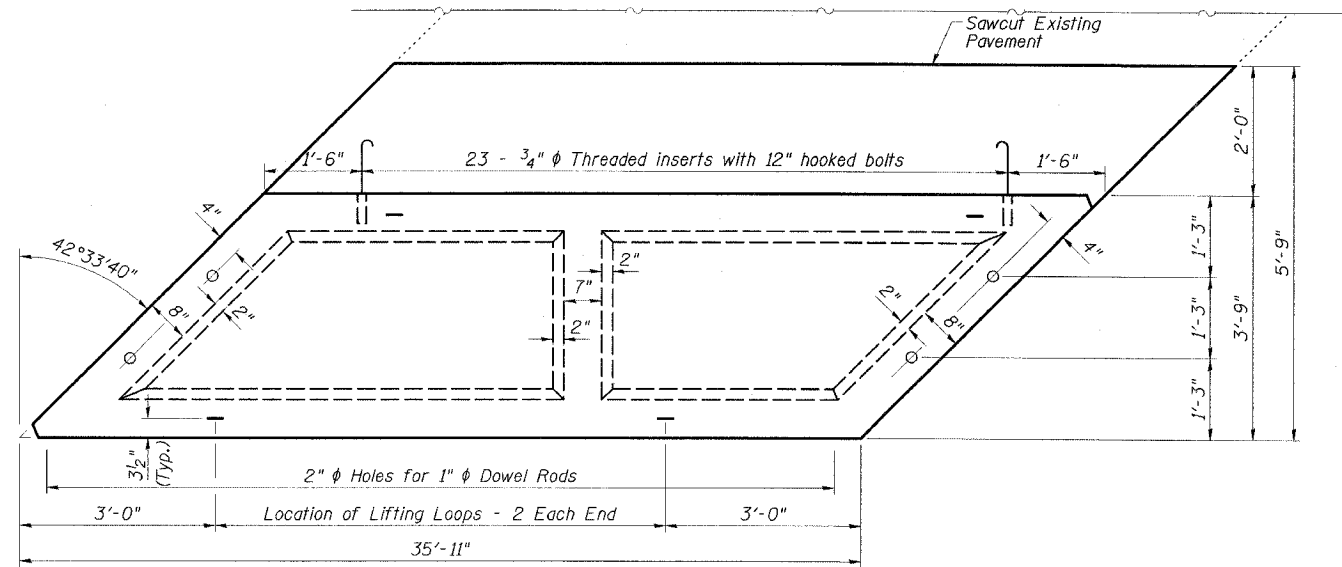

PARTIAL PLAN OF APPROACH

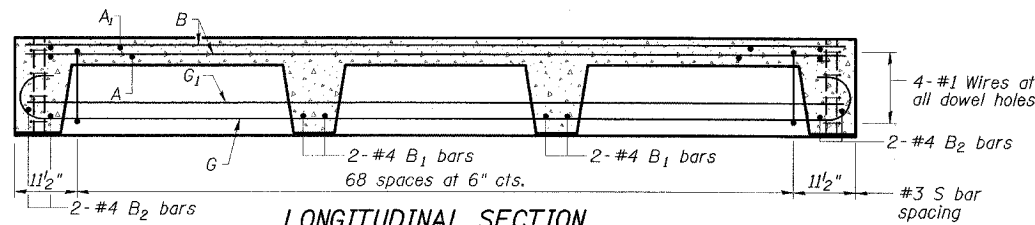

LONGITUDINAL SECTION

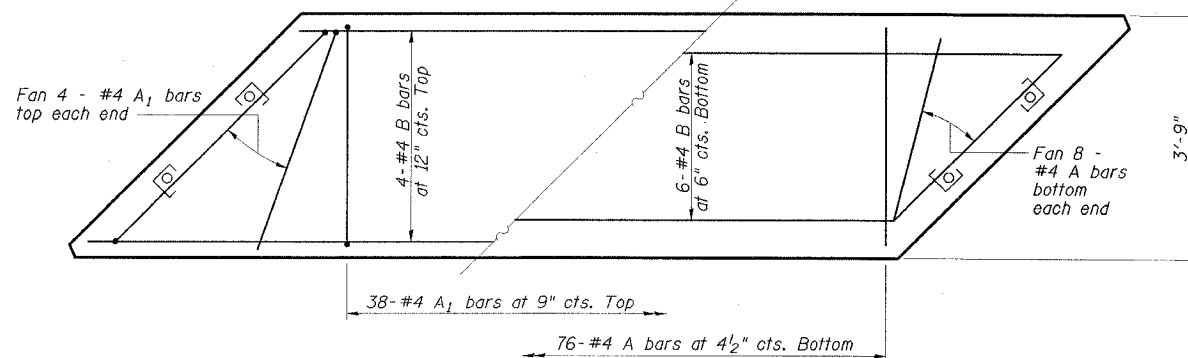

SLAB REINFORCEMENT

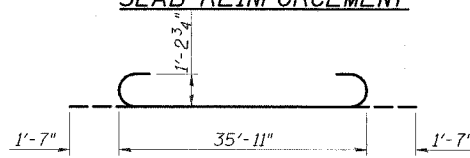

BAR G

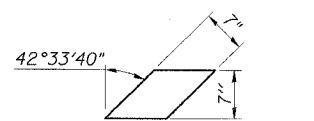

FABRIC BEARING PAD

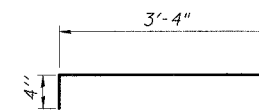

BAR A1

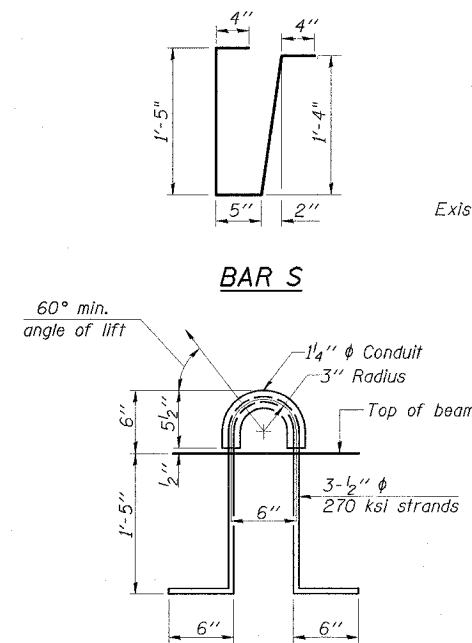

LIFTING LOOP DETAIL

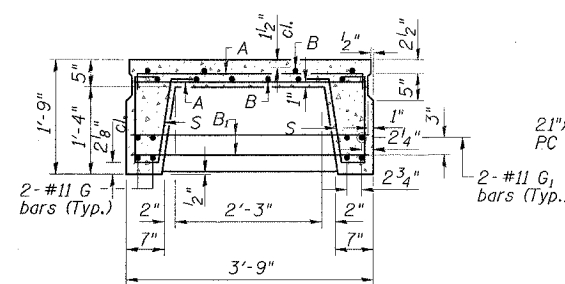

SECTION THRU PRECAST UNIT

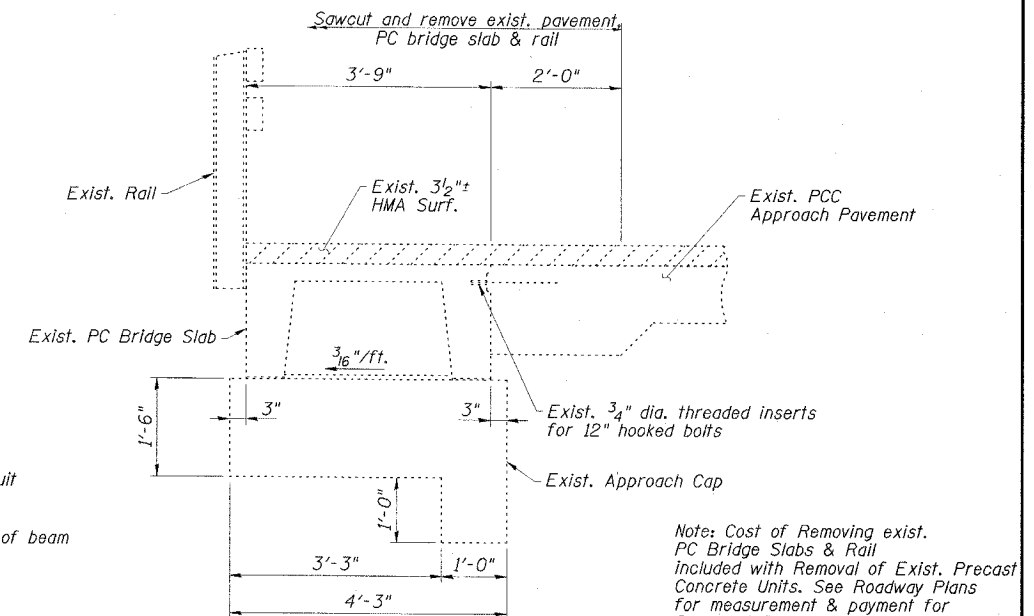

EXISTING CROSS SECTION

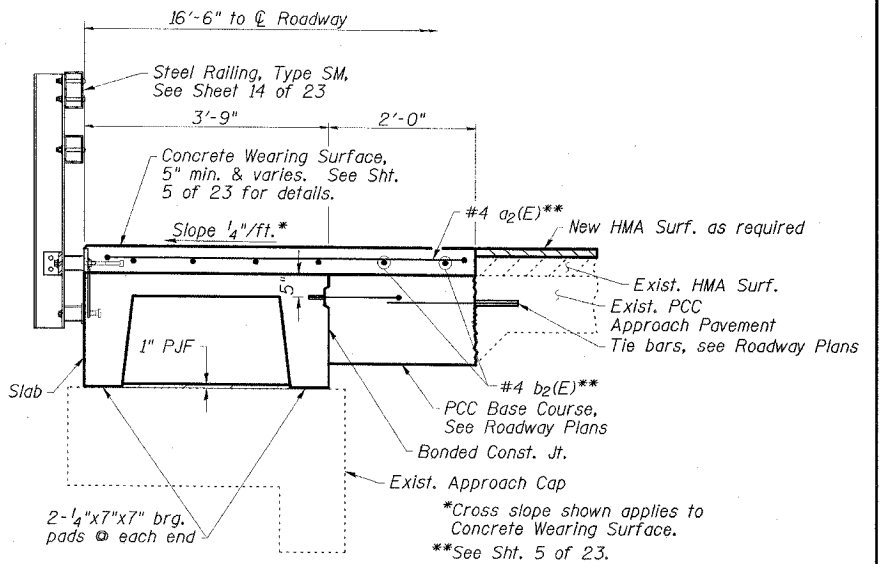

PROPOSED CROSS SECTION

NOTES

Reinforcing steel shall conform to ASTM A 706 (IL MOD), Grade 60.
The bearing seat surfaces shall be adjusted by shimming to assure firm and even bearing. Two 1/8" fabric adjusting shims of the dimensions of the Bearing Pad shall be provided for each bearing.
Keyway surfaces shall be cleaned to remove form oil or other bond breaking material prior to shipment of the slabs. Cleaning shall be done by sandblasting the keyway areas between top of the slab and the bottom edge of the key.
Corrosion Inhibitor, per Article 1020.05(b)(12) of the Standard Specifications, shall be used in the concrete for precast concrete bridge slabs.
Required Strength, f'c, shall be 4500 p.s.i.
See Sht. No. 2 of 23 for location of rail anchors and additional notes.
Cost of reinforcement and accessories cast into the slab unit, bearing pads, furnishing, drilling for, placing and grouting anchor rods and 3/4" hooked bolts is included in contract Unit Price for "Precast Concrete Bridge Slab."
The Precast Concrete Bridge Slab shall be erected and aligned with the exterior face of the exterior Deck Beam after Deck Beams are in final position.
A minimum of 2 1/2" lifting pin shall be used to engage the lifting loops during handling.

BILL OF MATERIAL

Item	Unit	Quantity
Precast Concrete Bridge Slab	Sq. Ft.	270

APPROACH DETAILS

IL 34 OVER
MIDDLE FORK SALINE RIVER
FAP ROUTE 869 - SECTION 105BR-2
SALINE COUNTY
STATION 1561+70.00
STRUCTURE NO. 083-0038

ESCA
CONSULTANTS, INC.

DESIGNED BY:	JMS	02/08
DRAWN BY:	HAS	02/08
CHECKED BY:	ELH	02/08
APPROVED BY:	RDP	02/08