

SECTION	COUNTY	TOTAL SHEETS	SHEET NO.
CH	A47	LAKE	176
STATIONING		TO STA.	
03-00088-00-FP		SURFACE TRANSPORTATION FUNDING	

CONTRACT NUMBER 83807

- LEGEND**
- 1 EXISTING BITUMINOUS PAVEMENT
  - 2 EXISTING CONCRETE PAVEMENT
  - 3 EXISTING PAVEMENT MARKING (WHITE LINE)
  - 4 EXISTING PAVEMENT MARKING (DOUBLE YELLOW LINE)
  - 5 PROP. TEMPORARY PAINT PAVEMENT MARKING 4" WHITE (LINE)
  - 6 PROP. TEMPORARY PAINT PAVEMENT MARKING 6" WHITE (LINE)
  - 7 PROP. TEMPORARY PAINT PAVEMENT MARKING 4" YELLOW (DOUBLE LINE)
  - 8 PROP. PAVEMENT MARKING TAPE, TYPE III 4" (WHITE LINE)
  - 9 GRAVEL SHOULDER REMOVAL-PAID FOR AS "EARTH EXCAVATION (SPECIAL)"
  - 10 PROP. PAVEMENT MARKING TAPE, TYPE III 4" (DOUBLE YELLOW LINE)
  - 11 PROP. PAVEMENT MARKING TAPE, TYPE III 6" (WHITE LINE)
  - 12 PROP. BITUMINOUS CONCRETE BINDER COURSE, SUPERPAVE, IL-19.0, NS0
  - 13 PROP. PREFORMED PLASTIC PAVEMENT MARKING, TYPE C - LINE 4" (WHITE SKIP-DASH LINE)
  - 14 TYPE II BARRICADE (NON-METALLIC) W/STEADY-BURN LIGHT
  - 15 PAVEMENT REMOVAL
  - 16 COMBINATION CURB & GUTTER REMOVAL
  - 17 BITUMINOUS SHOULDER REMOVAL-PAID FOR AS "EARTH EXCAVATION (SPECIAL)"
- DIRECTION OF SINGLE LANE OF THRU TRAFFIC DURING PHASE
- TEMPORARY PAVEMENT WIDENING
- PERMANENT CONSTRUCTION DURING PHASE
- \*BIT. BASE COURSE, SUPERPAVE, 8" WITH NO BINDER OR SURFACE COURSE, OR P.C. CONCRETE PAVEMENT, 6" WITH NO PAVEMENT FABRIC
- \*\*SEE TYPICAL SECTIONS AND PLAN AND PROFILE SHEETS

CONSTRUCTION SEQUENCE	
<b>PHASE 1A (SHEETS 25-27)</b>	
1.	ERECT ALL ADVANCE CONSTRUCTION SIGNING.
2.	CONSTRUCT TEMPORARY SIDEWALK ON SOUTHEAST CORNER OF DEERFIELD PARKWAY AND BUFFALO GROVE ROAD.
3.	INSTALL AND ACTIVATE TEMPORARY TRAFFIC SIGNALS AND REMOVE EXISTING SIGNALS AT DEERFIELD PARKWAY AND BUFFALO GROVE ROAD.
4.	CONSTRUCT MAIN STORM SEWERS ON NORTH AND SOUTH SIDES OF DEERFIELD PARKWAY.
5.	REMOVE TREES AND RELOCATE LIGHT POLES, FIRE HYDRANTS AND TRAFFIC SIGNS WHERE NECESSARY, REMOVE BITUMINOUS AND GRAVEL SHOULDERS AND CONSTRUCT TEMPORARY PAVEMENT WIDENING ON SOUTH SIDE OF DEERFIELD PARKWAY.
6.	REMOVE PORTIONS OF EXISTING MEDIANS AT EAST AND WEST ENDS AND REPLACE WITH TEMPORARY PAVEMENT.
<b>PHASE 1B (SHEETS 28-31)</b>	
1.	REMOVE CONFLICTING PAVEMENT MARKINGS AND PLACE TEMPORARY MARKINGS, ERECT BARRICADES AND TEMPORARY TRAFFIC SIGNALS, ADJUST TEMPORARY TRAFFIC SIGNALS AND SHIFT DEERFIELD PARKWAY TRAFFIC TO SOUTH SIDE.
2.	CONSTRUCT STORM SEWER LATERALS ON NORTH SIDE OF DEERFIELD PARKWAY AND ALL STORM SEWERS ON BUFFALO GROVE ROAD.
3.	CONSTRUCT TWO WESTBOUND LANES ON DEERFIELD PARKWAY, AND OUTSIDE PAVEMENT WIDENING ON WEST SIDE OF BUFFALO GROVE ROAD AND HIGHLAND GROVE DRIVE.
4.	CONSTRUCT OUTSIDE PAVEMENT WIDENING ON EAST SIDE OF BUFFALO GROVE ROAD AND HIGHLAND GROVE DRIVE.
5.	BEGIN INSTALLATION OF PERMANENT TRAFFIC SIGNALS AND ROADWAY LIGHTING.
<b>PHASE 2 (SHEETS 32-34)</b>	
1.	REMOVE CONFLICTING PAVEMENT MARKINGS AND PLACE TEMPORARY MARKINGS, RELOCATE BARRICADES, ERECT TEMPORARY TRAFFIC SIGNALS, ADJUST TEMPORARY TRAFFIC SIGNALS AND SHIFT DEERFIELD PARKWAY TRAFFIC TO NORTH SIDE.
2.	CONSTRUCT ALL REMAINING STORM SEWERS.
3.	CONSTRUCT TWO EASTBOUND LANES ON DEERFIELD PARKWAY.
4.	PLACE PERMANENT PAVEMENT MARKINGS ON BUFFALO GROVE ROAD, OPEN ALL LANES TO TRAFFIC, PLACE BARRICADES AND MODIFY MEDIAN.
<b>PHASE 3 (SHEETS 35-37)</b>	
1.	REMOVE TEMPORARY PAVEMENT MARKINGS AND RE-MARK EXISTING PAVEMENT WITH PERMANENT MARKINGS, RELOCATE BARRICADES, ADJUST TEMPORARY TRAFFIC SIGNALS AND OPEN EASTBOUND AND WESTBOUND THRU LANES ON DEERFIELD PARKWAY TO TRAFFIC.
2.	CONSTRUCT LEFT-TURN LANES AND MEDIAN ON DEERFIELD PARKWAY, AND REMOVE TEMPORARY PAVEMENT AND RECONSTRUCT MEDIANS AT EACH END.
<b>PHASE 4 (NOT ILLUSTRATED)</b>	
1.	COMPLETE AND ACTIVATE ALL PERMANENT TRAFFIC SIGNAL INSTALLATIONS AND REMOVE TEMPORARY SIGNALS AT DEERFIELD PARKWAY AND BUFFALO GROVE ROAD.
2.	COMPLETE ROADWAY LIGHTING INSTALLATION.
3.	REMOVE ALL CONFLICTING PAVEMENT MARKINGS, PLACE SHORT-TERM MARKINGS AND PERMANENT SIGNING, REMOVE ALL BARRICADES AND OPEN ALL ROADWAYS TO TRAFFIC.
4.	REMOVE TEMPORARY PAVEMENT MARKINGS, PLACE PERMANENT MARKINGS AND PERMANENT SIGNING, AND REMOVE ALL BARRICADES AND TEMPORARY TRAFFIC SIGNALS.
5.	COMPLETE ALL REMAINING LANDSCAPING AND CLEAN-UP WORK.

REVISIONS	
NAME	DATE

VILLAGE OF BUFFALO GROVE

**STAGES OF CONSTRUCTION**

**DEERFIELD PARKWAY IMPROVEMENT**

TYPICAL SECTIONS

DATE: 6/2/2005  
DESIGNED BY: RJK  
TECHNICIAN: JRR  
CHECKED BY: MLH

NOT TO SCALE

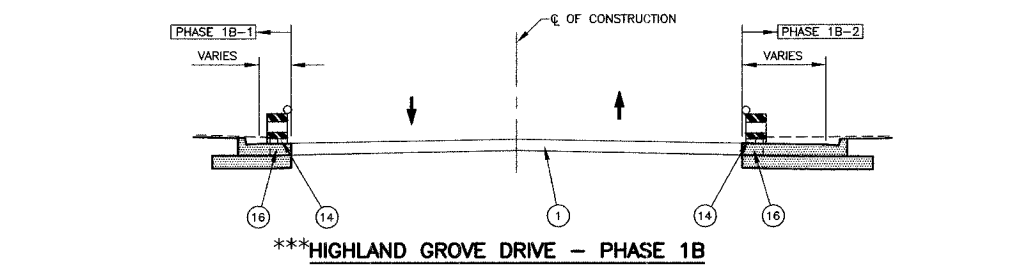
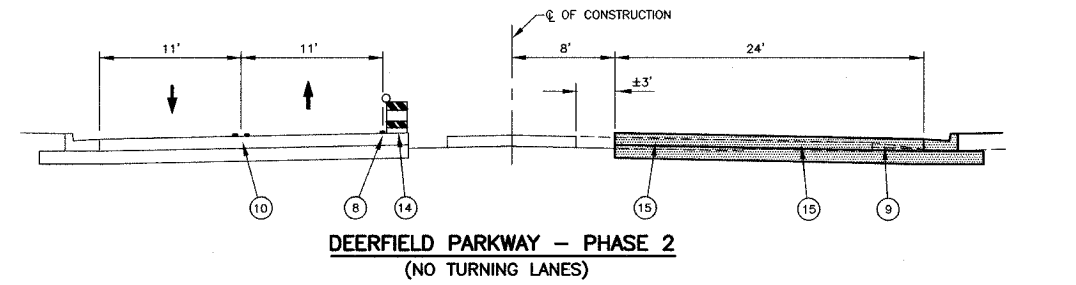
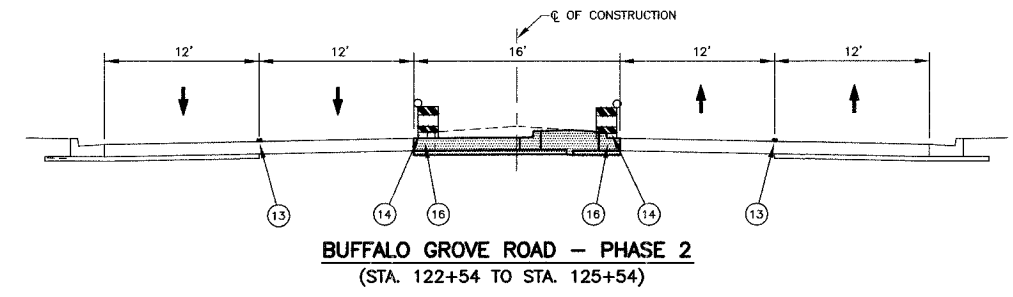
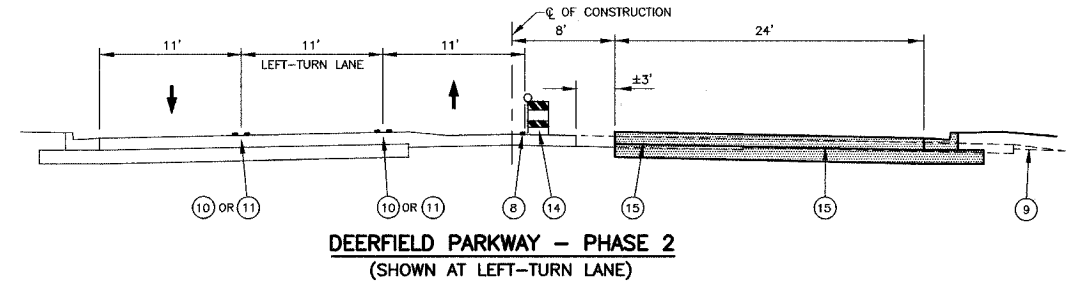
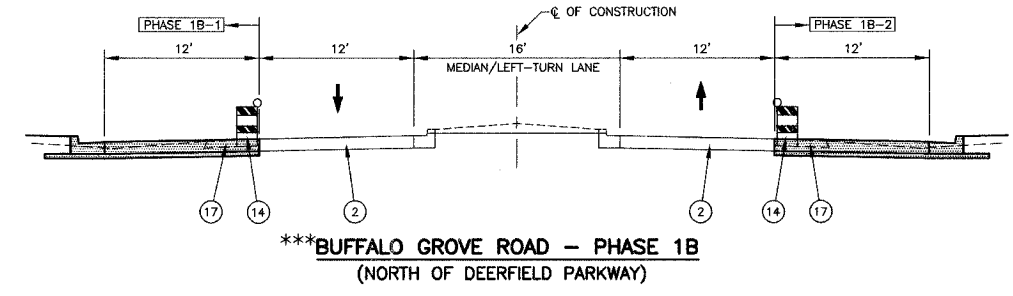
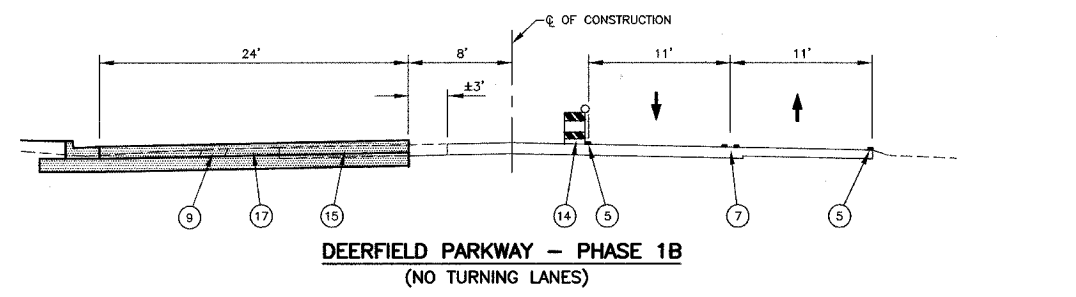
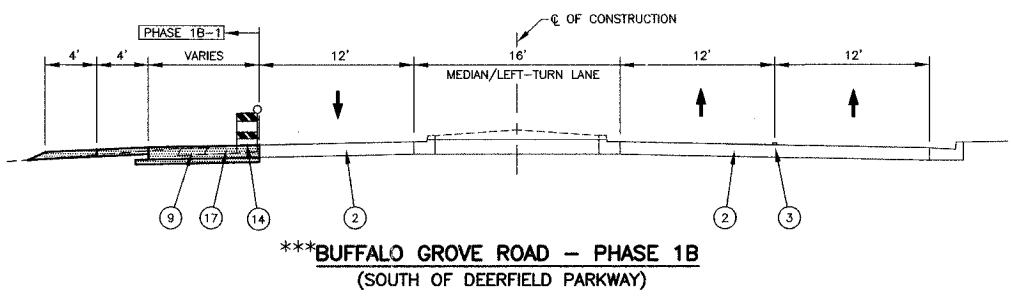
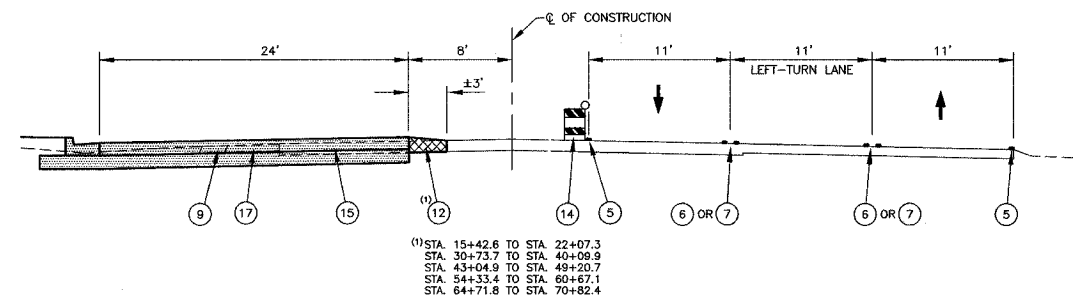
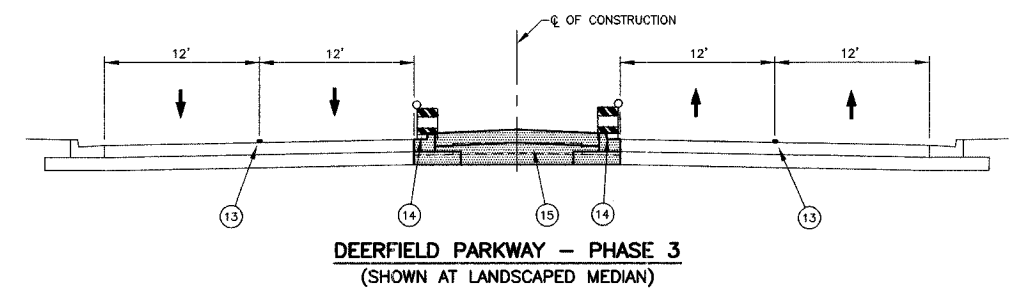
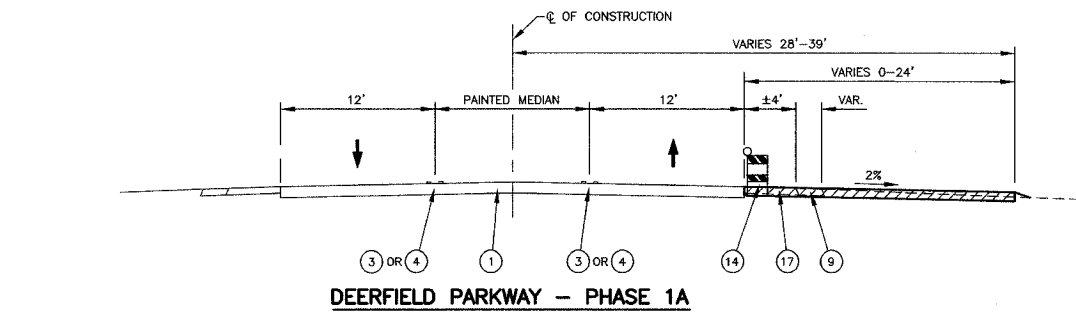

\*\*\*PHASE 1B PAVEMENT WIDENING ON BUFFALO GROVE ROAD & HIGHLAND GROVE DRIVE SHALL BE COMPLETED AND OPENED TO TRAFFIC ON THE WEST SIDE BEFORE WORK MAY BEGIN ON THE EAST SIDE.