

CONTRACT NO.				
F.A. RTE.	SECTION	COUNTY	TOTAL SHEETS	SHEET NO.
852	18B	WILL	31	30
STA.		TO STA.		
FED. ROAD DIST. NO.		ILLINOIS FED. AID PROJECT		

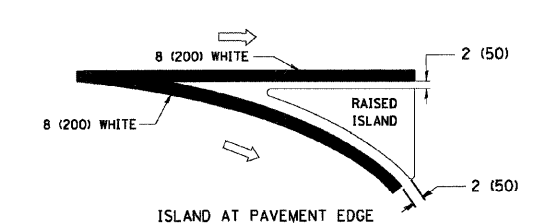

TYPICAL ISLAND MARKING

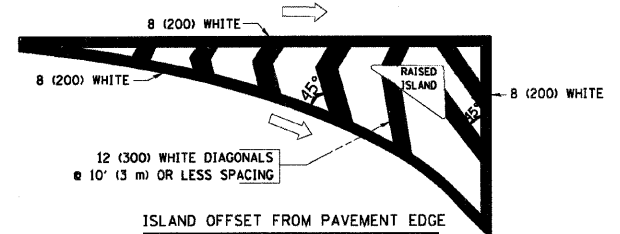
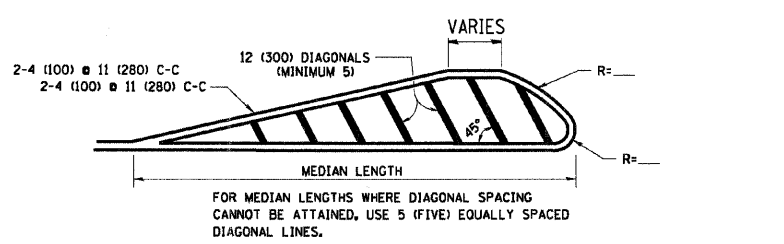
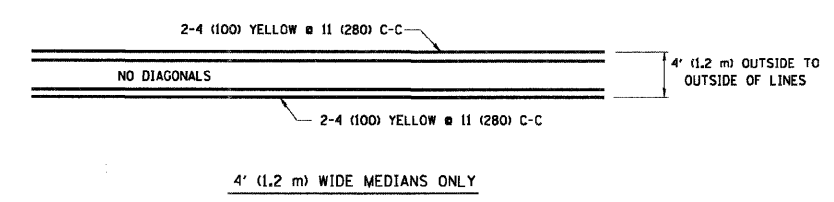
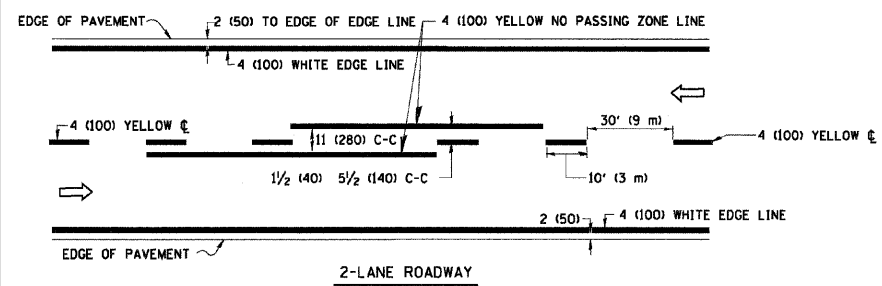
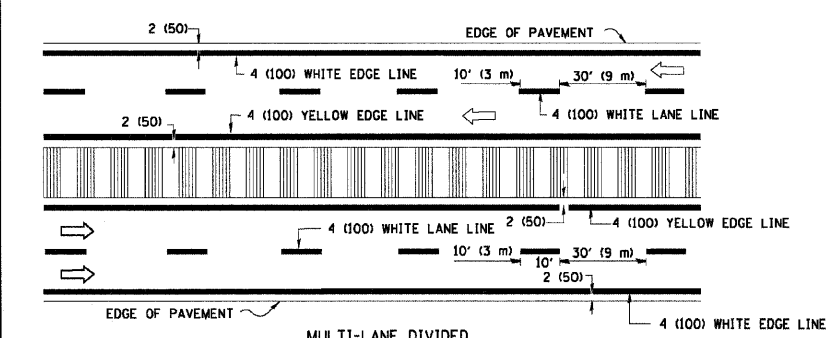
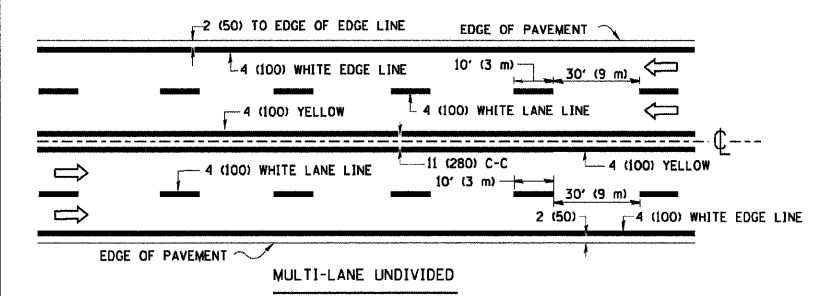

NOTE: MEDIANS WITH BARRIER CURB DO NOT REQUIRE AN EDGE LINE

TYPICAL LANE AND EDGE LINE MARKING

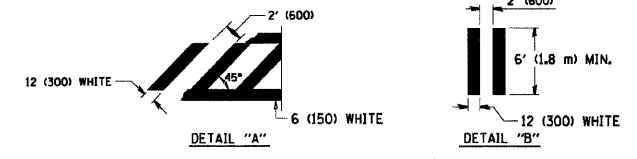
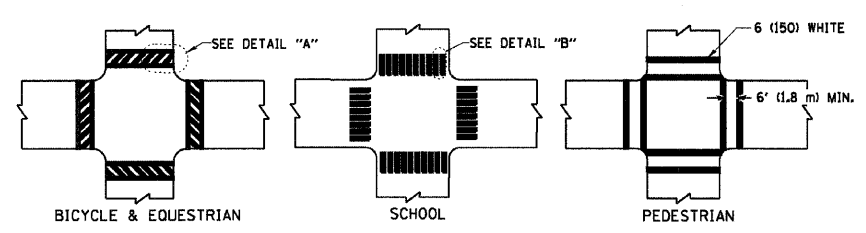

TYPICAL CROSSWALK MARKING

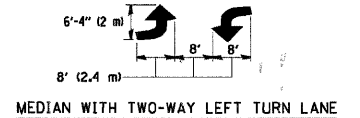
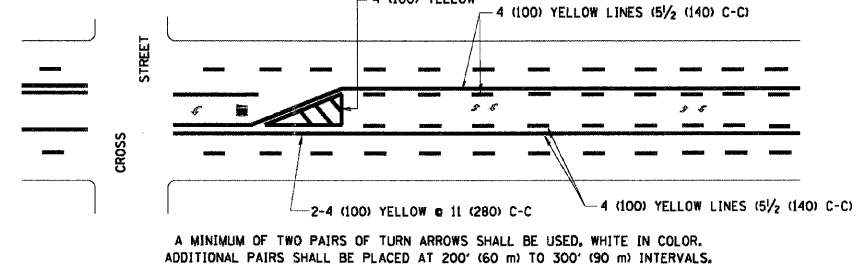

TYPICAL PAINTED MEDIAN MARKING

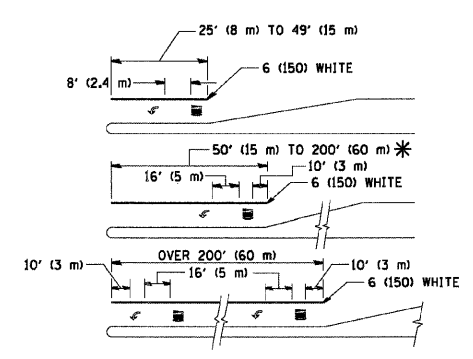

FULL SIZE LETTERS 8" (2.4 m) AND ARROWS SHALL BE USED.
AREA = 15.6 SQ. FT. (1.5 m²) ONLY AREA = 20.8 SQ. FT. (1.9 m²)

* TURN LANES IN EXCESS OF 400' (120 m) IN LENGTH MAY HAVE AN ADDITIONAL SET OF ARROW - "ONLY" INSTALLED MIDWAY BETWEEN THE OTHER TWO SETS OF ARROW - "ONLY".

TYPICAL LEFT (OR RIGHT) TURN LANE

TYPICAL TURN LANE MARKING

TYPE OF MARKING	WIDTH OF LINE	PATTERN	COLOR	SPACING / REMARKS
CENTERLINE ON 2 LANE PAVEMENT	4 (100)	SKIP-DASH	YELLOW	10' (3 m) LINE WITH 30' (9 m) SPACE
CENTERLINE ON MULTI-LANE UNDIVIDED PAVEMENT	2 & 4 (100)	SOLID	YELLOW	11 (280) C-C
NO PASSING ZONE LINES: FOR ONE DIRECTION	4 (100)	SOLID	YELLOW	5/2 (140) C-C FROM SKIP-DASH CENTERLINE
FOR BOTH DIRECTIONS	2 & 4 (100)	SOLID	YELLOW	11 (280) C-C OMIT SKIP-DASH CENTERLINE BETWEEN
LANE LINES	4 (100)	SKIP-DASH	WHITE	10' (3 m) LINE WITH 30' (9 m) SPACE
	5 (125) ON FREEWAYS	SKIP-DASH	WHITE	
DOTTED LINES (EXTENSIONS OF CENTER, LANE OR TURN LANE MARKINGS)	SAME AS LINE BEING EXTENDED	SKIP-DASH	SAME AS LINE BEING EXTENDED	2' (600) LINE WITH 6' (1.8 m) SPACE
EDGE LINES	4 (100)	SOLID	YELLOW-LEFT WHITE-RIGHT	OUTLINE MOUNTABLE MEDIANS IN YELLOW; EDGE LINES ARE NOT USED NEXT TO BARRIER CURB
TURN LANE MARKINGS	6 (150) LINES; FULL SIZE LETTERS & SYMBOLS (8" (2.4m))	SOLID	WHITE	SEE TYPICAL TURN LANE MARKING DETAIL
TWO WAY LEFT TURN MARKING	2 & 4 (100) EACH DIRECTION	SKIP-DASH AND SOLID	YELLOW	10' (3 m) LINE WITH 30' (9 m) SPACE FOR SKIP-DASH; 5/2 (140) C-C BETWEEN SOLID LINE AND SKIP-DASH LINE
	8' (2.4m) LEFT ARROW	IN PAIRS	WHITE	SEE TYPICAL TWO-WAY LEFT TURN MARKING DETAIL
CROSSWALK LINES (PEDESTRIAN)	2 & 6 (150)	SOLID	WHITE	NOT LESS THAN 6' (1.8 m) APART
A. DIAGONALS (BIKE & EQUESTRIAN)	2 (300) @ 45°	SOLID	WHITE	2' (600) APART
B. LONGITUDINAL BARS (SCHOOL)	12 (300) @ 90°	SOLID	WHITE	2' (600) APART
STOP LINES	24 (600)	SOLID	WHITE	PLACE 4' (1.2 m) IN ADVANCE OF AND PARALLEL TO CROSSWALK, IF PRESENT. OTHERWISE, PLACE AT DESIRED STOPPING POINT. PARALLEL TO CROSSROAD CENTERLINE, WHERE POSSIBLE
PAINTED MEDIANS	2 & 4 (100) WITH 12 (300) DIAGONALS @ 45°	SOLID	YELLOW; TWO WAY TRAFFIC WHITE; ONE WAY TRAFFIC	11 (280) C-C FOR THE DOUBLE LINE SEE TYPICAL PAINTED MEDIAN MARKING.
CORE MARKING AND CHANNELIZING LINES	8 (200) WITH 12 (300) DIAGONALS @ 45°	SOLID	WHITE	DIAGONALS: 15' (4.5 m) C-C (LESS THAN 30MPH (50 km/h)) 20' (6 m) C-C 30MPH (50 km/h) TO 45MPH (70 km/h) 30' (9 m) C-C (OVER 45MPH (70 km/h))
RAILROAD CROSSING	24 (600) TRANSVERSE LINES; "RR" IS 6' (1.8 m) LETTERS; 16 (400) LINE FOR "X"	SOLID	WHITE	SEE STATE STANDARD 780001 AREA OF: "RR"=3.6 SQ. FT. (0.33 m ²) EACH "X"=54.0 SQ. FT. (5.0 m ²)
SHOULDER DIAGONALS	12 (300) @ 45°	SOLID	WHITE - RIGHT YELLOW - LEFT	50' (15 m) C-C (LESS THAN 30MPH (50 km/h)) 75' (25 m) C-C (30 MPH (50 km/h) TO 45MPH (70 km/h)) 150' (45 m) C-C (OVER 45MPH (70 km/h))

FOR FURTHER DETAILS ON PAVEMENT MARKING REFER TO STANDARD SPECIFICATIONS FOR ROAD AND BRIDGE CONSTRUCTION AND STATE STANDARD 780001.

All dimensions are in inches (millimeters) unless otherwise shown.

REVISIONS	
NAME	DATE
EVERS	03-19-90
T. RAMMACHER	10-27-94
ALEX HOUSEH	10-09-96
ALEX HOUSEH	10-17-96
T. RAMMACHER	01-06-00

ILLINOIS DEPARTMENT OF TRANSPORTATION

DISTRICT ONE

TYPICAL PAVEMENT MARKINGS

SCALE: NONE

DRAWN BY CADD

CHECKED BY

PLOT DATE = 3/6/2007
FILE NAME = K:\projects\1033.dgn
PLOT SCALE = 0.000000 / IN.
USER NAME = baurdi