

TYPICAL MINI-SKIP PAVEMENT MARKINGS

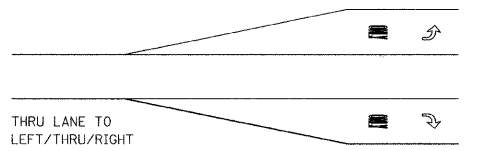
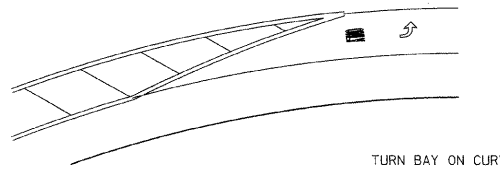
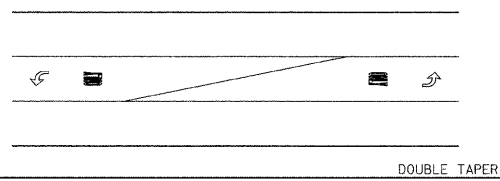
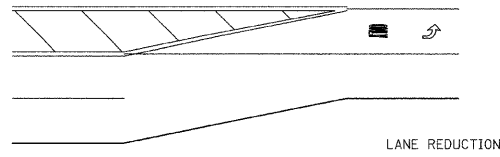

MINI-SKIPS ARE 2 FEET WHITE LINE WITH 6 FEET SPACING. THE MINI-SKIP IS THE SAME WIDTH AS THE PAVEMENT MARKING LINE, IT EXTENDS.

TYPICAL PAVEMENT MARKINGS

TYPICAL TURN BAY PAVEMENT MARKINGS

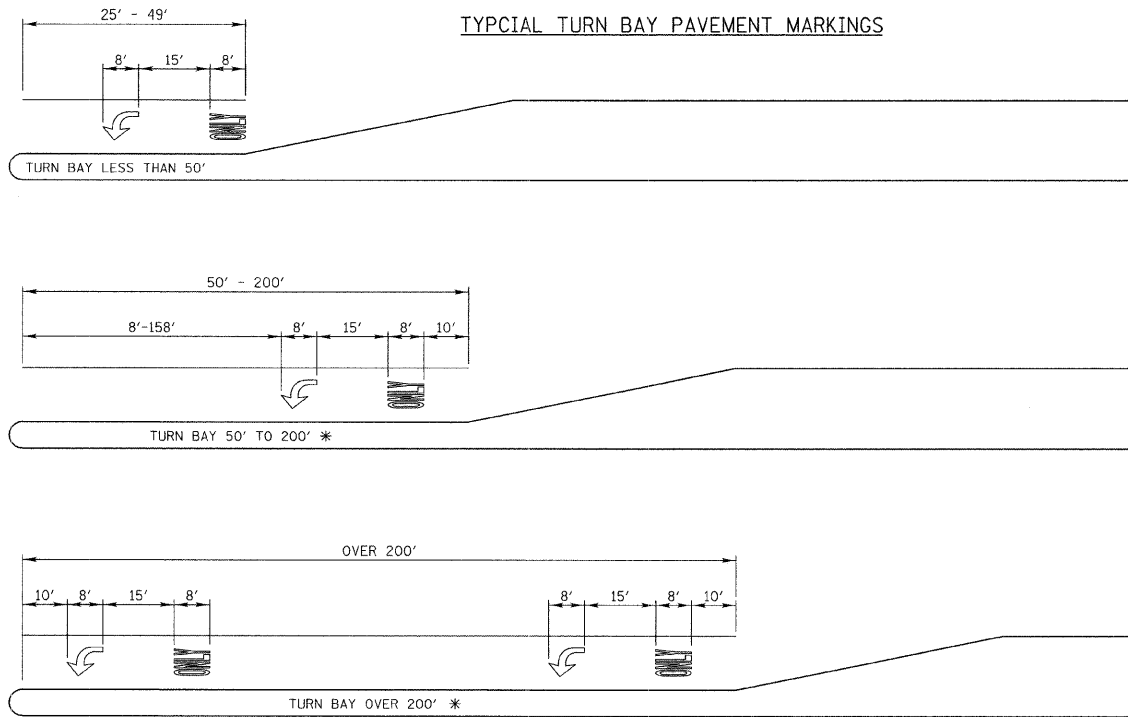

* AT INTERSECTIONS WITH VIDEO DETECTION, THE ARROW AND ONLY PAVEMENT MARKINGS SHALL BE A MINIMUM OF 30' BEHIND THE STOP BAR.

AREA = 15.6 SQ. FT.

AREA = 20.8 SQ. FT.

FULL SIZE LETTERS (8") AND ARROWS SHALL BE USED. TURN LANES IN EXCESS OF 400' IN LENGTH MAY HAVE AN ADDITIONAL SET OF ARROW W/ "ONLY" INSTALLED MIDWAY BETWEEN THE OTHER TWO SETS OF ARROW W/ "ONLY".

EDGE LINE RADII AT SIDE STREETS

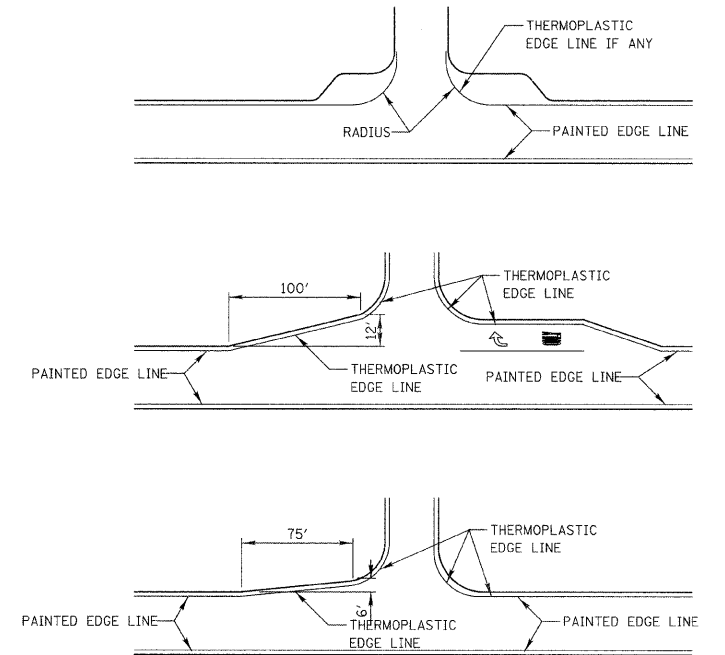

TWO LANE ROAD

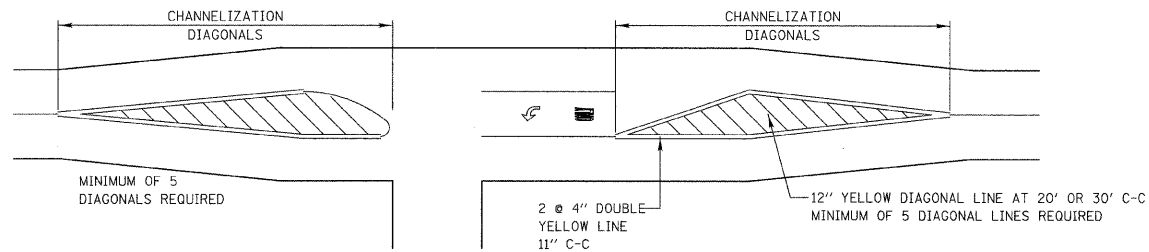

TYPICAL DIAGONAL SPACING

SPEED LIMIT RANGE	DIAGONAL SPACING	
	CONTINUOUS	INTERSECTION CHANNELIZATION
30-45 MPH	75 FT.	20 FT.
OVER 45 MPH	150 FT.	30 FT.

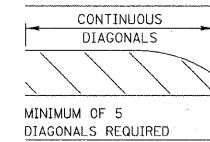

3 TO 5 LANE ROAD

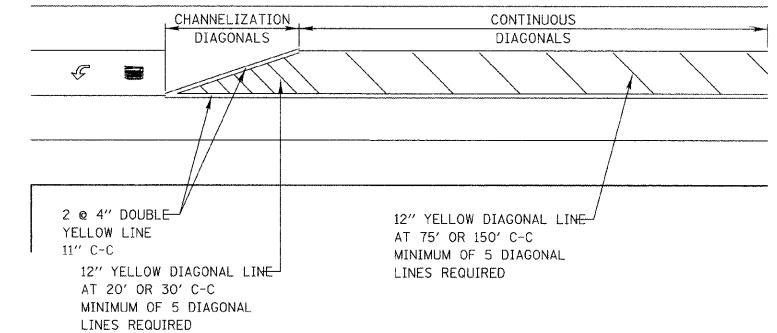

TWO-WAY LEFT TO LEFT TURN BAY

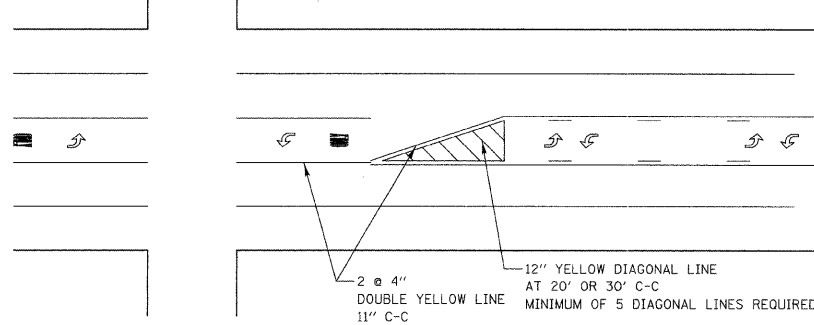

DUAL LEFT TURN ARROWS



31.2 SQ. FT. MINIMUM OF 2 SETS REQUIRED

A MINIMUM OF TWO PAIRS OF DUAL LEFT TURN ARROWS SHALL BE USED. THE DUAL LEFT TURN ARROWS SHALL BE WHITE IN COLOR. THE INTERVAL BETWEEN SETS OF DUAL LEFT TURN ARROWS SHOULD BE 200' AND 300'.

REVISIONS	DATE	LakeCounty Division of Transportation	APPROVED BY: A. KHAWAJA DATE: APRIL 1, 2007

REVISIONS / REMARKS				
NO.	DESCRIPTION	DATE	BY	SURVEYOR:



LAKE COUNTY STANDARDS & DETAILS

ROUTE	SECTION	SECTION NUMBER	SHEET	SHEETS
1230		03-00159-00-PV	202	262