

ROLLED THREAD DOWEL BAR

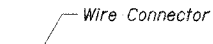

\*\* ONE PIECE



WIRE CONNECTOR

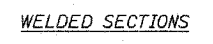

WELDED SECTIONS

**BAR SPLICER ASSEMBLY ALTERNATIVES**

\*\* Heavy Hex Nuts conforming to ASTM A 563, Grade C, D or DH may be used.

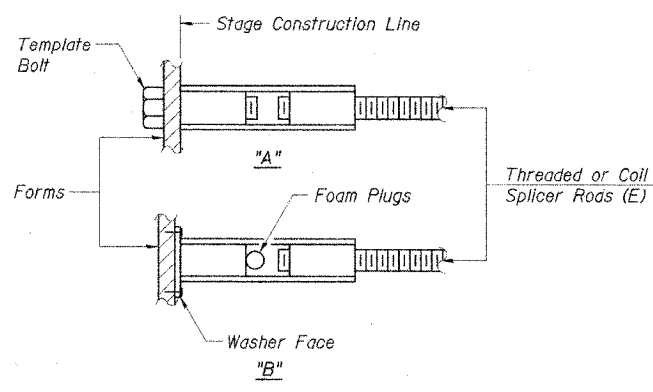

**INSTALLATION AND SETTING METHODS**

"A" : Set bar splicer assembly by means of a template bolt.  
 "B" : Set bar splicer assembly by nailing to wood forms or cementing to steel forms.  
 (E) : Indicates epoxy coating.

**NOTES**

Bar splicer assemblies shall be of an approved type and shall develop in tension at least 125 percent of the yield strength of the lapped reinforcement bars.  
 Splicer rods shall be of minimum 60 ksi yield strength, threaded or coiled full length.  
 All reinforcement bars shall be lapped and tied to the splicer rods or dowel bars.  
 Bar splicer assemblies shall be epoxy coated according to the requirements for reinforcement bars.  
 Other systems of similar design may be submitted to the Engineer for approval. Approval shall be based on certified test results from an approved testing laboratory that the proposed bar splicer assembly satisfies the following requirements:

- ① Minimum Capacity (Tension in kips) =  $1.25 \times f_y \times A_t$
  - ② Minimum \*Pull-out Strength (Tension in kips) =  $0.66 \times f_y \times A_t$
- Where  $f_y$  = Yield strength of lapped reinforcement bars in ksi.  
 $A_t$  = Tensile stress area of lapped reinforcement bars.  
 \* = 28 day concrete

Bar Size to be Spliced	Splicer Rod or Dowel Bar Length	Strength Requirements	
		Min. Capacity kips - tension	Min. Pull-Out Strength kips - tension
#4	1'-8"	14.7	7.9
#5	2'-0"	23.0	12.3
#6	2'-7"	33.1	17.4
#7	3'-5"	45.1	23.8
#8	4'-6"	58.9	31.3
#9	5'-9"	75.0	39.6
#10	7'-3"	95.0	50.3
#11	9'-0"	117.4	61.8

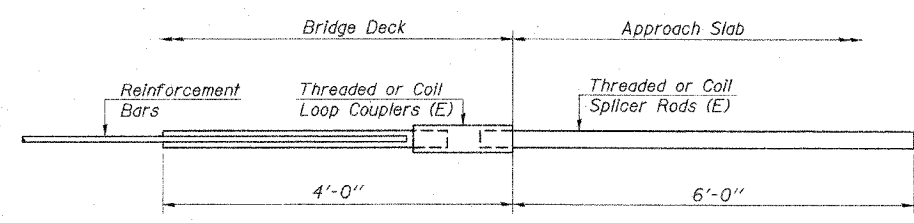

**FOR INTEGRAL OR SEMI-INTEGRAL ABUTMENTS**

Bar Splicer for #5 bar
Min. Capacity = 23.0 kips - tension
Min. Pull-out Strength = 12.3 kips - tension
No. Required = 102

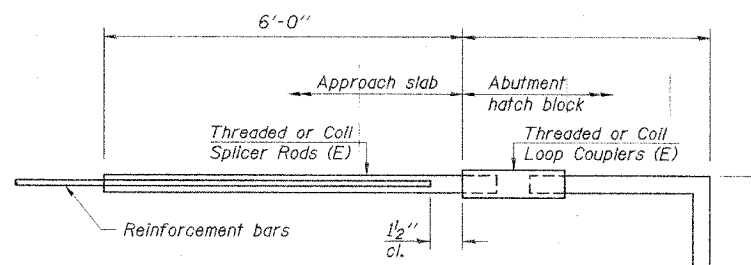

**FOR STUB ABUTMENTS**

Bar Splicer for #5 bar
Min. Capacity = 23.0 kips - tension
Min. Pull-out Strength = 12.3 kips - tension
No. Required =

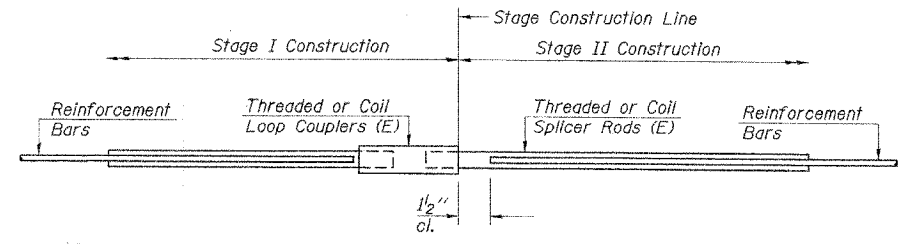

**STANDARD**

Bar Size	No. Assemblies Required	Location
#5	469	Deck
#6	16	Diaphragm
#5	6	Abutments
#7	20	Abutments
#5	8	Piers
#6	58	Piers
#7	16	Piers

REVISIONS	
NAME	DATE

CITY OF SPRINGFIELD, ILLINOIS  
**BAR SPLICER ASSEMBLY DETAILS**  
 FAU 8006-BRUNS LANE OVER SPRING CREEK  
 SECTION 05-00444-00-BR  
 SANGAMON COUNTY  
 STATION 115+77.50 S.N. 084-6017  
 SCALE: NONE DRAWN BY: GLD  
 DATE: 6/19/07 CHECKED BY: WK

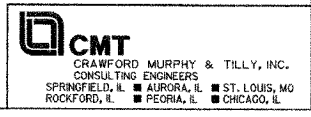

L:\Springfield\0502503\Drawings\BAR SPLICER DTLS.dgn 6/12/2007