

STATE OF ILLINOIS
DEPARTMENT OF TRANSPORTATION

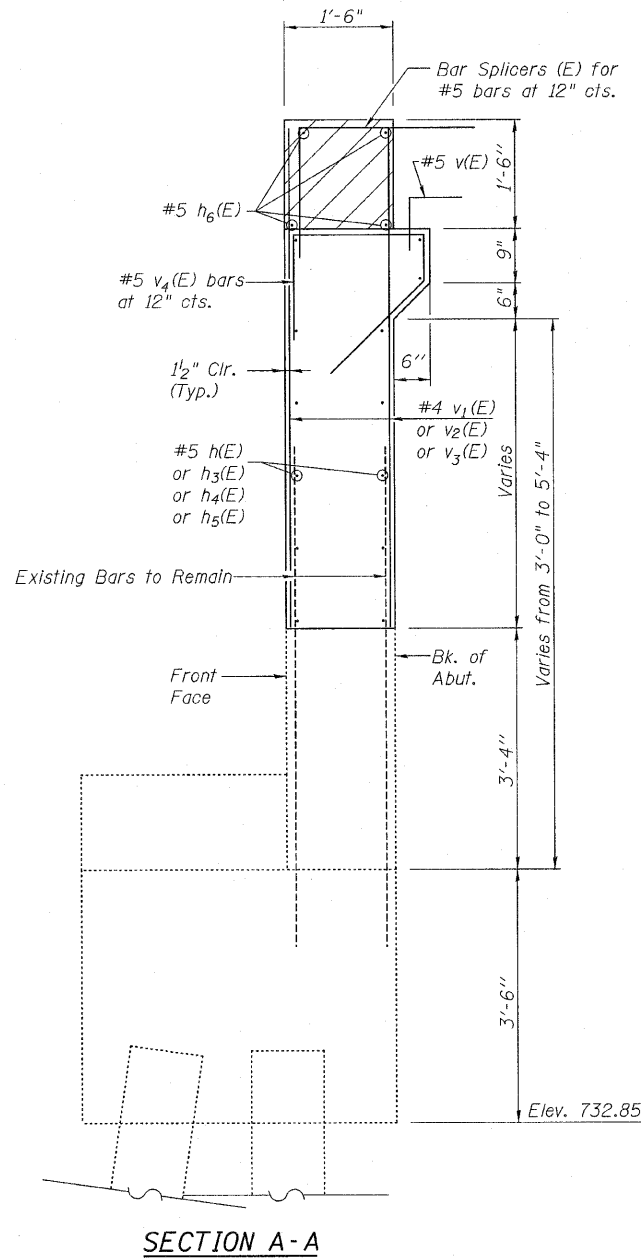

SECTION A-A

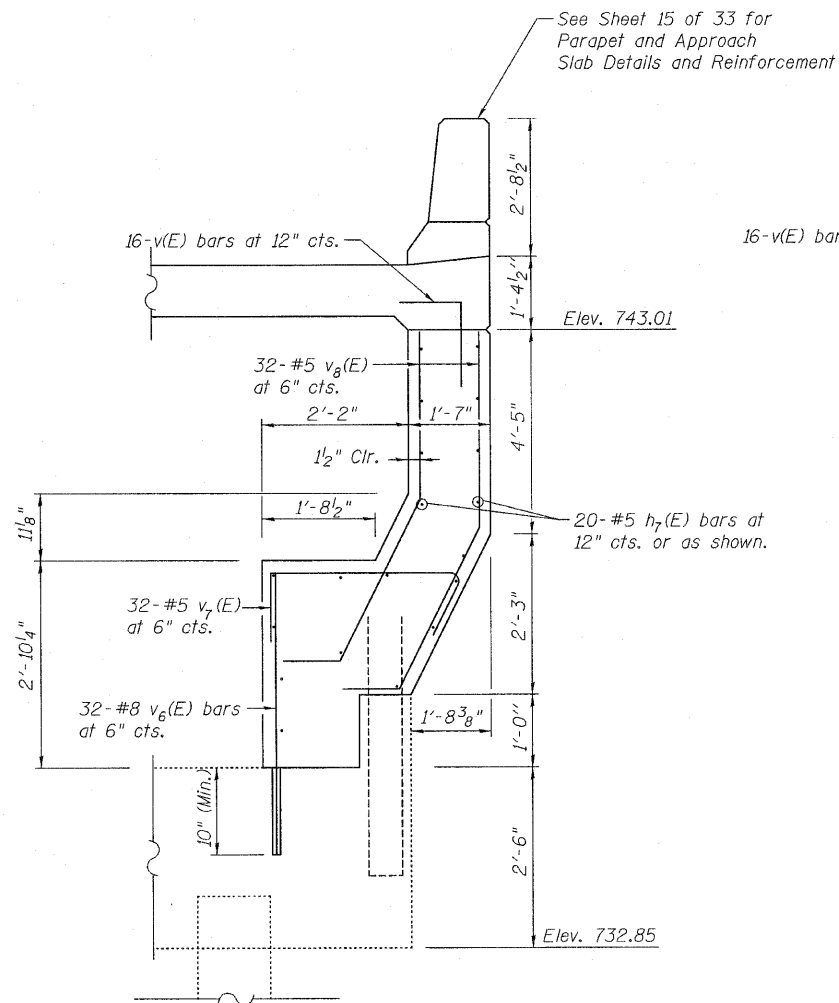

SECTION B-B

*Denotes Bar to be Cut-in-Field.

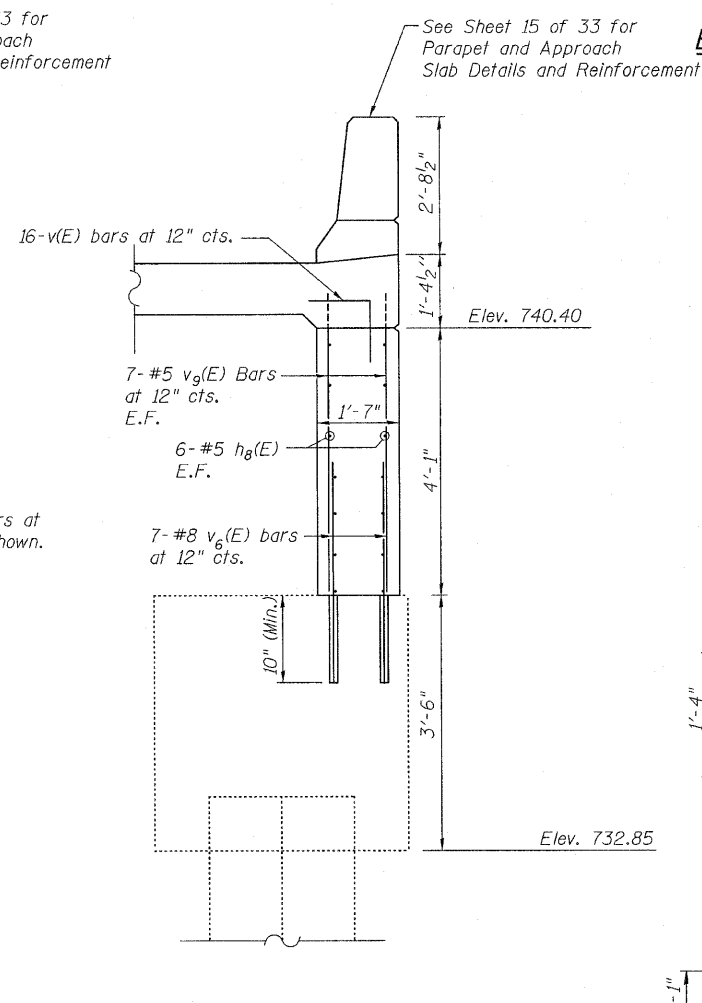

SECTION C-C

See Sheet 29 of 33 for Similar Elevation.

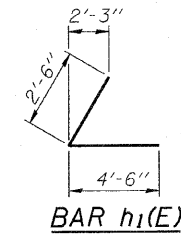

BAR h1(E)

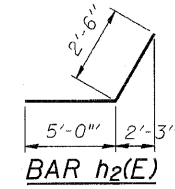

BAR h2(E)

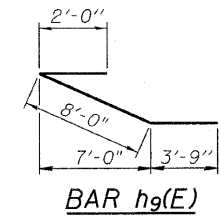

BAR h9(E)

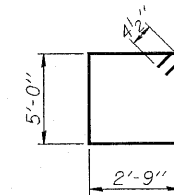

BARS s(E)

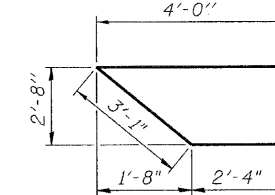

BAR u(E)

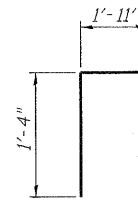

BAR v(E)

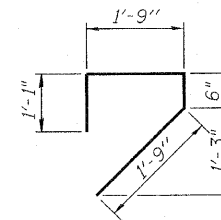

BAR v4(E)

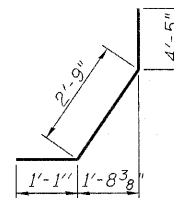

BAR v8(E)

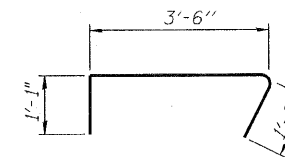

BAR v7(E)

S. ABUTMENT
BILL OF MATERIAL

Bar	No.	Size	Length	Shape
h(E)	8	#5	34'-6"	—
h1(E)	20	#5	7'-0"	└
h2(E)	12	#5	7'-6"	└
h3(E)	2	#4	44'-9"	—
h4(E)	2	#4	25'-3"	—
h5(E)	2	#4	7'-3"	—
h6(E)	8	#6	35'-0"	—
h7(E)	20	#5	15'-0"	—
h8(E)	12	#5	16'-0"	—
h9(E)	2	#5	13'-9"	└
s(E)	4	#4	16'-6"	□
u(E)	6	#6	9'-5"	└
v(E)	97	#5	3'-3"	└
v1(E)	62	#4	13'-4"	—
v2(E)	2	#4	5'-3"	—
v3(E)	18	#4	6'-0"	—
v4(E)	65	#5	5'-1"	└
v5(E)	16	#5	4'-4"	—
v6(E)	32	#8	3'-6"	—
v7(E)	32	#5	5'-3"	└
v8(E)	64	#5	8'-3"	└
v9(E)	14	#5	4'-3"	—
Structure Excavation		Cu. Yd.		57
Concrete Structures		Cu. Yd.		44.2
Reinforcement Bars, Epoxy Coated		Pound		4,190
Concrete Sealer		Sq. Ft.		550

For details of Bar Splicers, see sheet 33 of 33.

SOUTH ABUTMENT DETAILS
STRUCTURE NO. 101-0123

DESIGNED	PRD
CHECKED	RKM
DRAWN	PRD
CHECKED	RKM

rjngroup
Excellence through Ownership
200 West Front Street
Wheaton, IL 60187
PH. 630.682.4700

SHEET NO. 27 OF 33 SHEETS	F.A.P. & F.A.U. RTE. & RTE.	SECTION	COUNTY	TOTAL SHEETS	SHEET NO.
	303 5146	1-HBR & 1-2HB-D	WINNEBAGO	216	143
CONTRACT NO. 64B79					
FED. ROAD DIST. NO. 2 ILLINOIS FED. AID PROJECT					