

STATE OF ILLINOIS
DEPARTMENT OF TRANSPORTATION

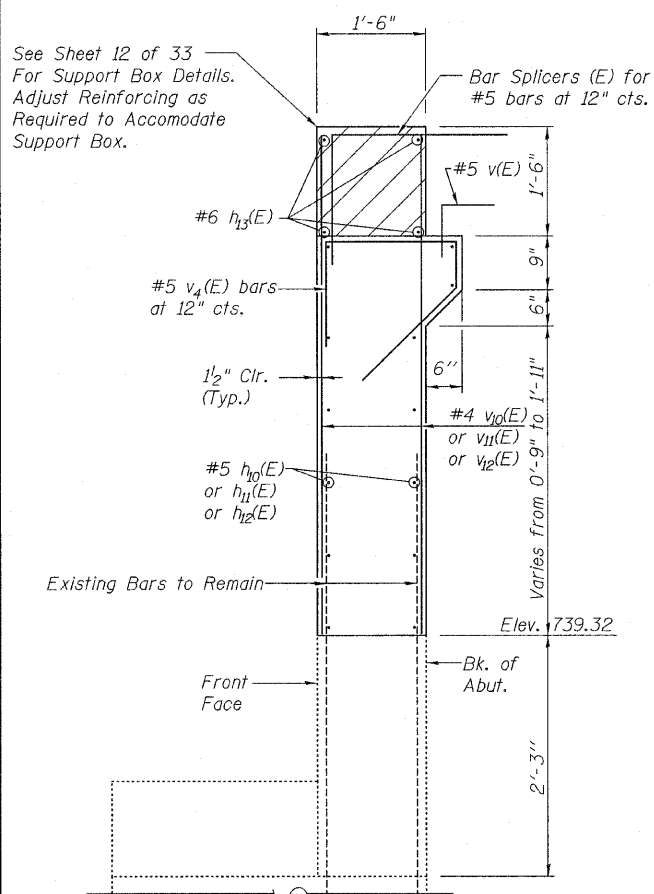

SECTION A-A

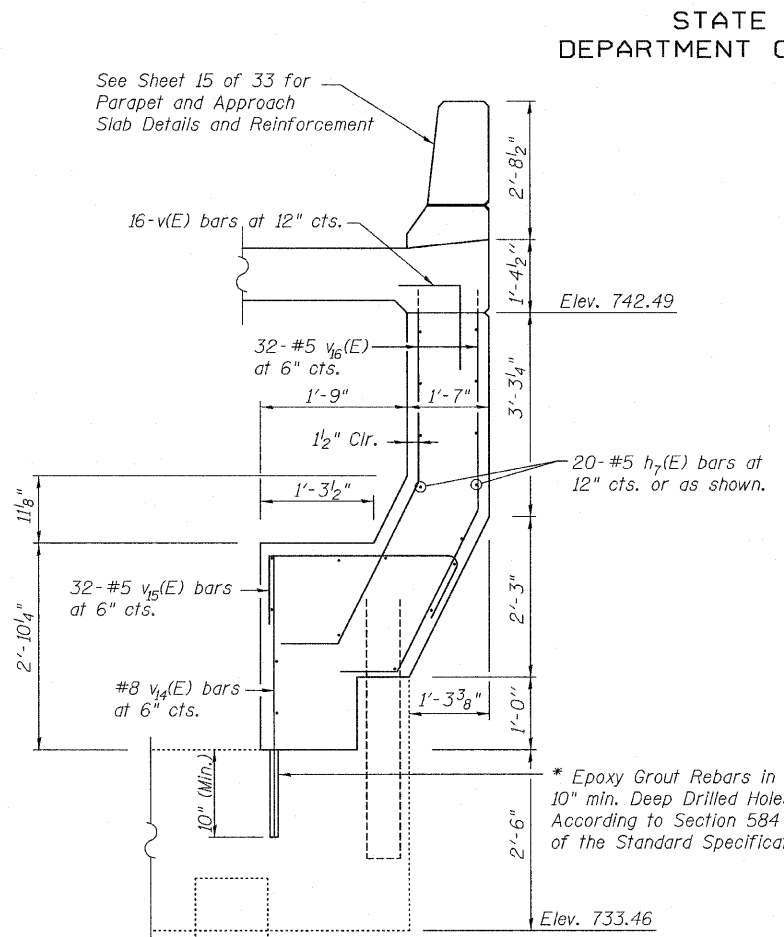

SECTION B-B

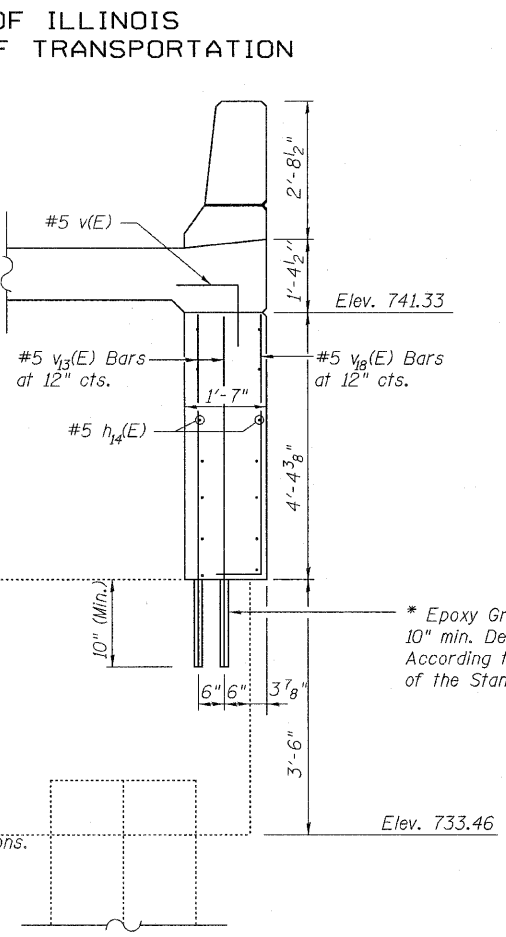

SECTION C-C

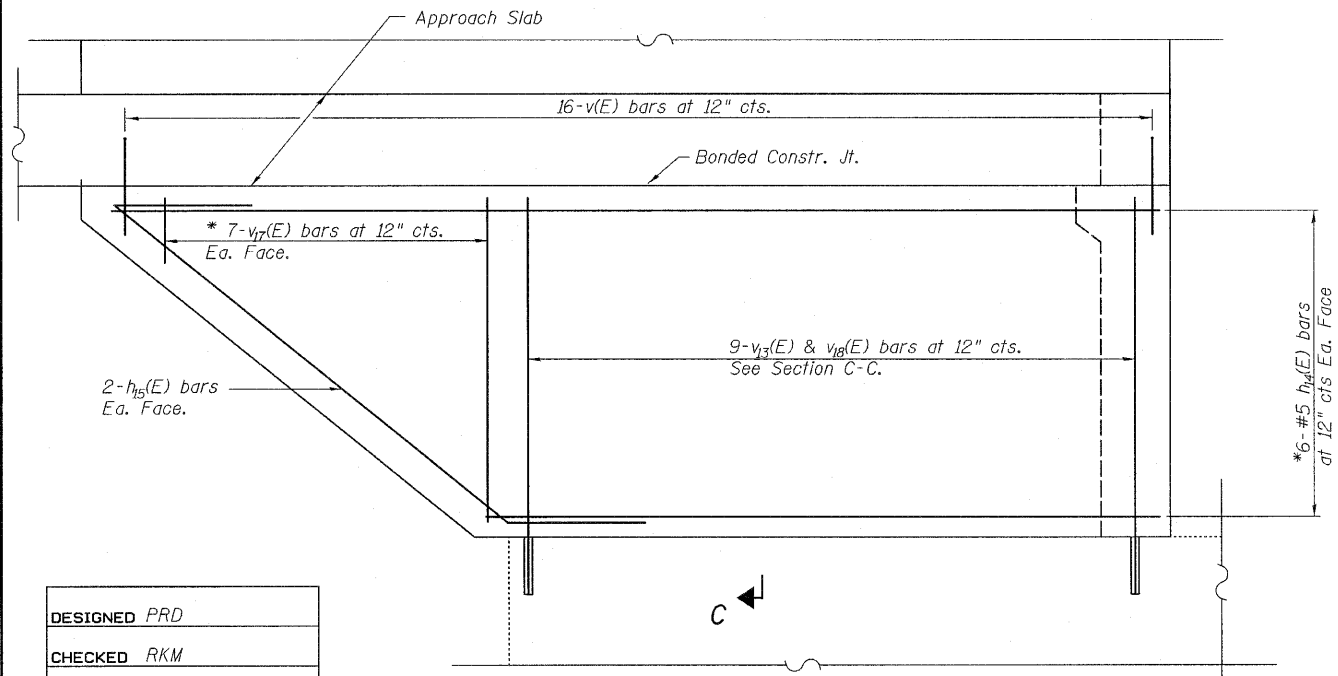

NorthWest Wingwall Elevation

SouthEast Wingwall Similar

* Bars to be Cut-in-Field.

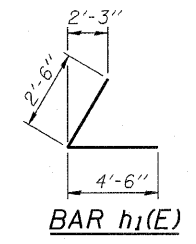

BAR h1(E)

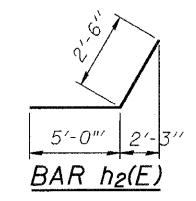

BAR h2(E)

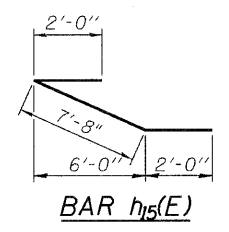

BAR h15(E)

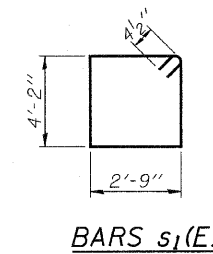

BARS s1(E)

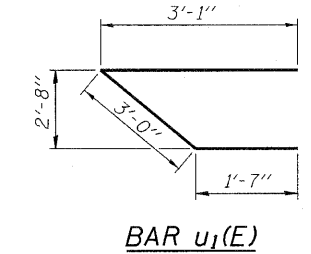

BAR u1(E)

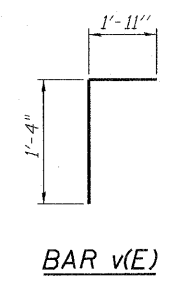

BAR v(E)

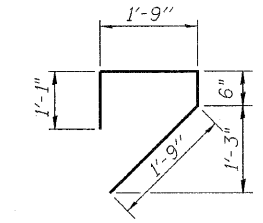

BAR v4(E)

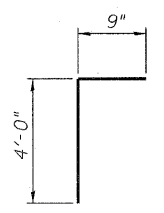

BAR v18(E)

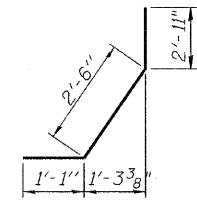

BAR v16(E)

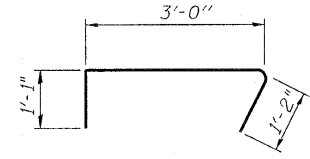

BAR v15(E)

N. ABUTMENT
BILL OF MATERIAL

Bar	No.	Size	Length	Shape
h1(E)	12	#5	7'-0"	└
h2(E)	14	#5	7'-6"	└
h7(E)	20	#5	15'-0"	—
h10(E)	12	#5	32'-8"	—
h11(E)	8	#4	1'-3"	—
h12(E)	4	#4	5'-0"	—
h13(E)	8	#6	32'-3"	—
h14(E)	6	#5	18'-0"	—
h15(E)	2	#5	11'-8"	└
s1(E)	3	#4	14'-7"	□
u1(E)	6	#6	7'-8"	└
v(E)	92	#5	3'-3"	└
v10(E)	104	#4	3'-6"	—
v11(E)	4	#4	6'-3"	—
v12(E)	10	#4	5'-3"	—
v4(E)	60	#5	5'-1"	└
v13(E)	18	#5	4'-10"	—
v14(E)	32	#8	3'-7"	—
v15(E)	32	#5	5'-3"	└
v16(E)	32	#5	6'-6"	└
v17(E)	14	#5	4'-6"	—
v18(E)	9	#5	4'-9"	—
Structure Excavation		Cu. Yd.	51	
Concrete Structures		Cu. Yd.	32.1	
Reinforcement Bars, Epoxy Coated		Pound	3,400	
Concrete Sealer		Sq. Ft.	428	

For details of Bar Splicers, see sheet 33 of 33.

NORTH ABUTMENT DETAILS
STRUCTURE NO. 101-0123

DESIGNED	PRD
CHECKED	RKM
DRAWN	PRD
CHECKED	RKM

rjngroup
Excellence through Ownership
200 West Front Street
Wheaton, IL 60187
PH. 630.682.4700

SHEET NO. 29 OF 33 SHEETS	F.A.P. & F.A.U. RTE. & RTE.	SECTION	COUNTY	TOTAL SHEETS	SHEET NO.
	303 5146	1-HBR & 1-2HB-D	WINNEBAGO	216	145
CONTRACT NO. 64B79					
FED. ROAD DIST. NO. 2 ILLINOIS FED. AID PROJECT					