

ROUTE NO	SECTION	COUNTY	TOTAL SHEETS	SHEET NO.
EA 18	103-D-BR	JO DAVIESS	27	12

SHEET 4 OF 16 SHEETS

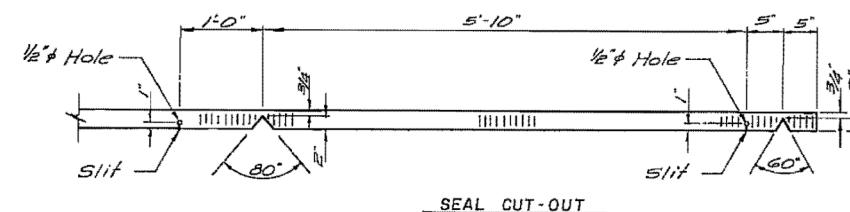

**END OF SEAL TREATMENT**  
Place P.J.S. after Stage II Construction

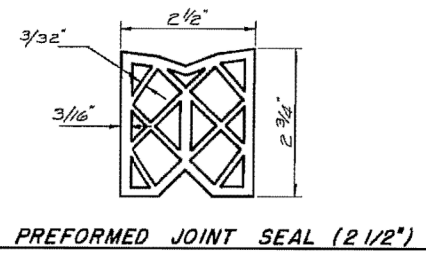
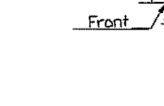
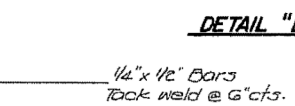
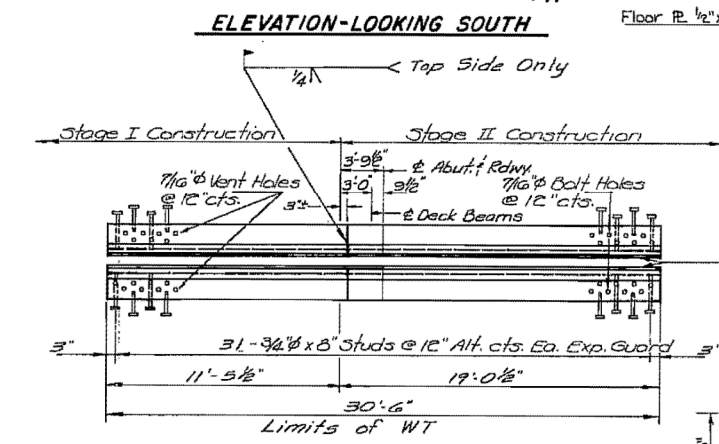
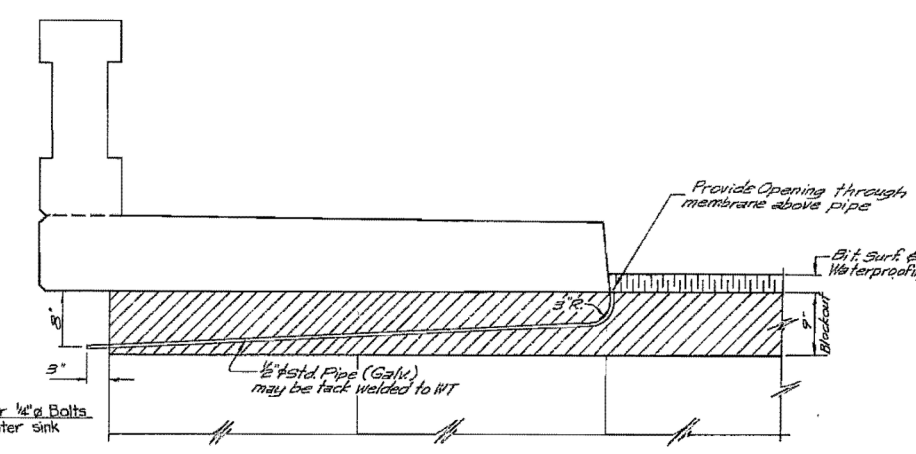
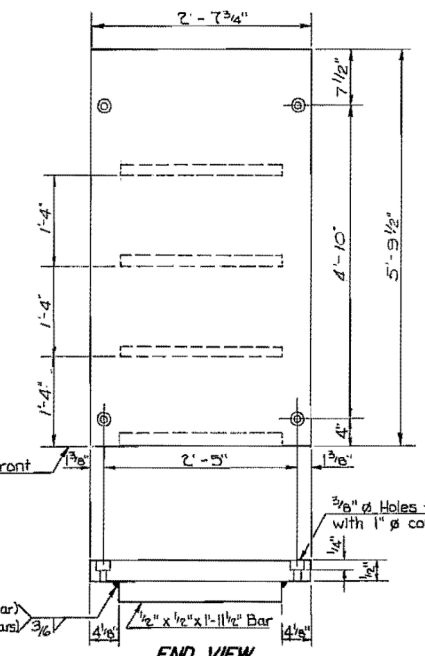
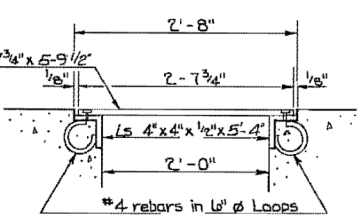
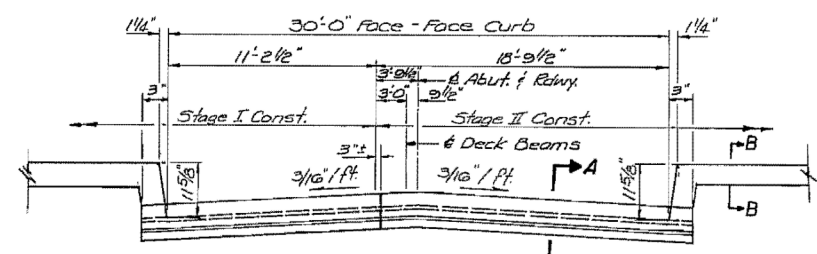
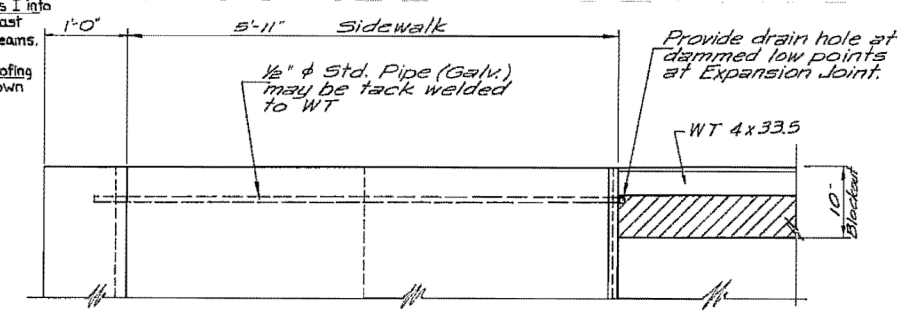
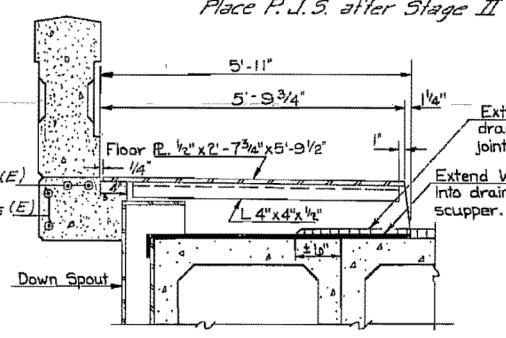
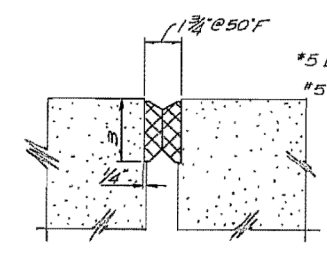
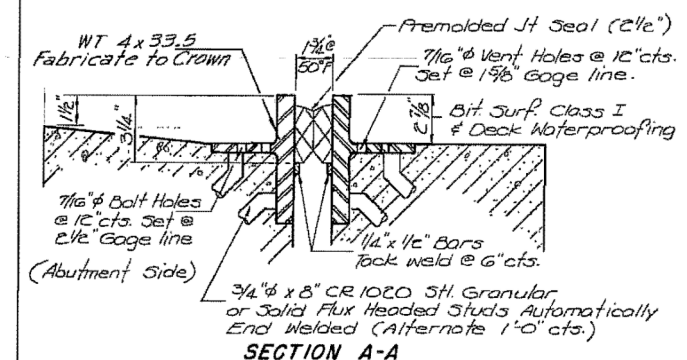
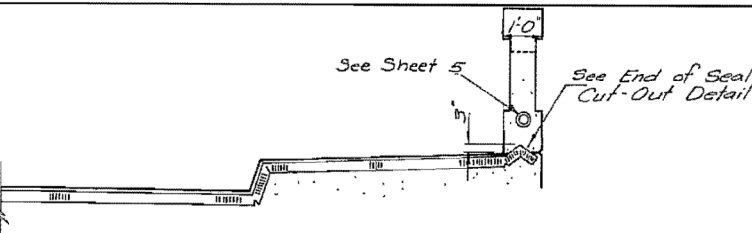

**FLOOR PLATE DETAILS**

**DRAIN HOLES AT EXPANSION JOINT**

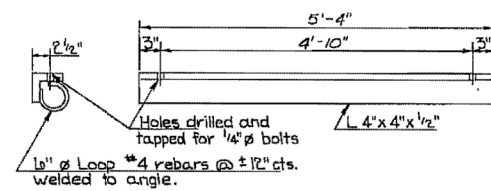

DESIGNED	V. S. N.
CHECKED	D. H. C.
DRAWN	R. A. W.
CHECKED	K. L. F.

**SUPERSTRUCTURE DECK  
FLOOR DRAIN SPECIAL &  
EXPANSION GUARD DETAILS**  
F.A. RTE. 18 OVER APPLE RIVER  
SECTION 103-D-BR  
JO DAVIESS COUNTY  
STATION 259 + 08.20

**FOR INFORMATION ONLY**