

OUTSIDE ELEVATION OF EAST SIDE HEADWALL/PARAPET

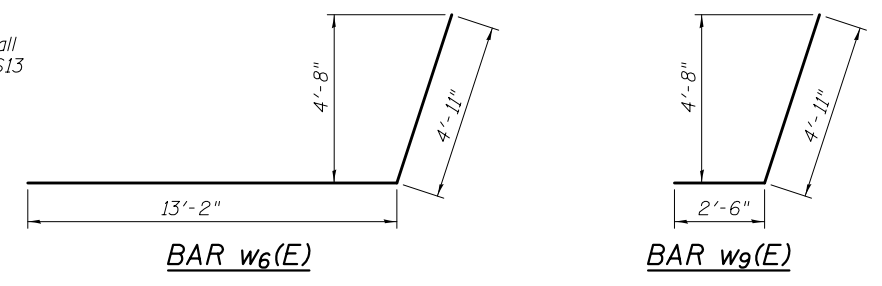
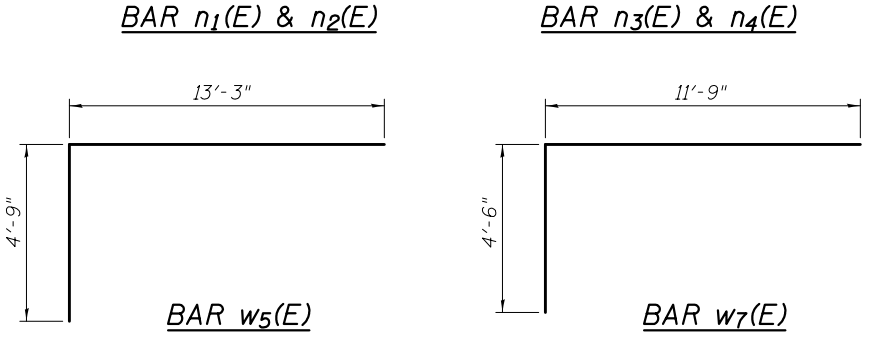
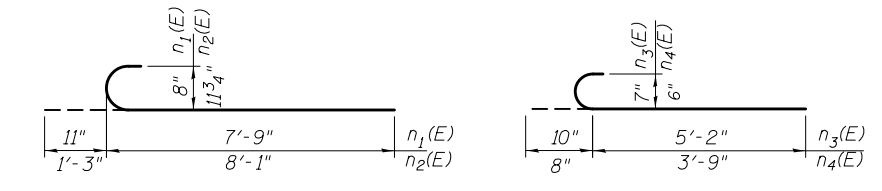

BAR BEND DIAGRAM

MIN. BAR LAP

- #4 = 2'-0"
- #5 = 2'-6"
- #6 = 3'-0"
- #7 = 3'-11"
- #8 = 5'-2"
- #9 = 6'-7"

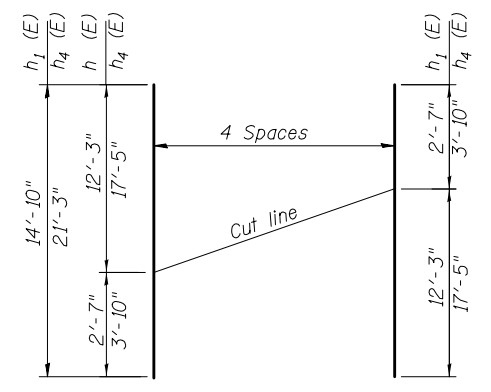

FIELD CUTTING DIAGRAM
Bars $h_1(E)$ & $h_4(E)$

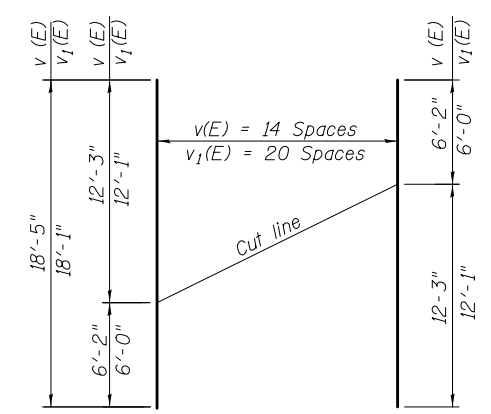

FIELD CUTTING DIAGRAM
Bars $v(E)$ & $v_1(E)$

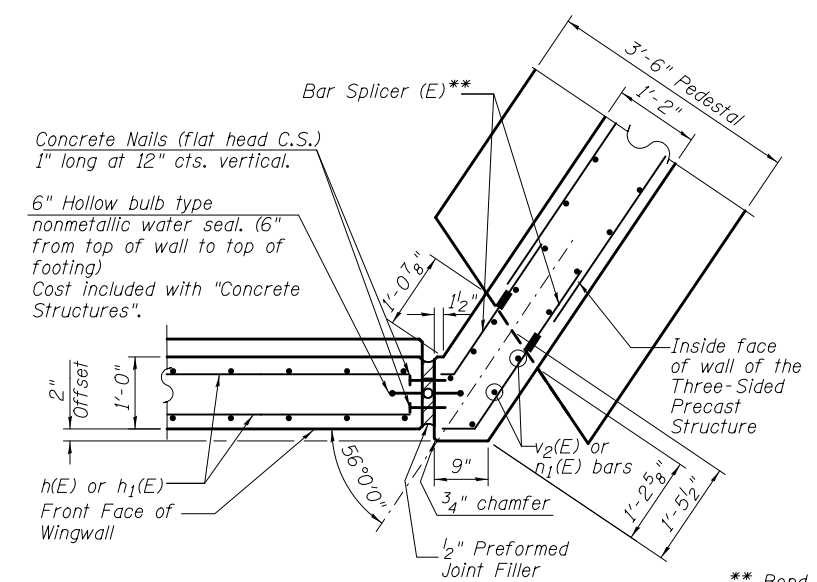

DETAIL A

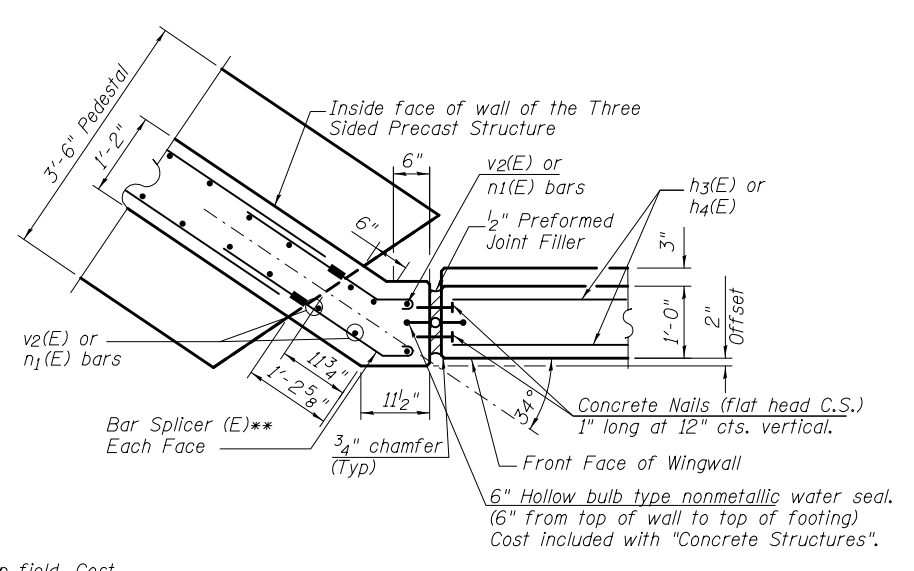

DETAIL B

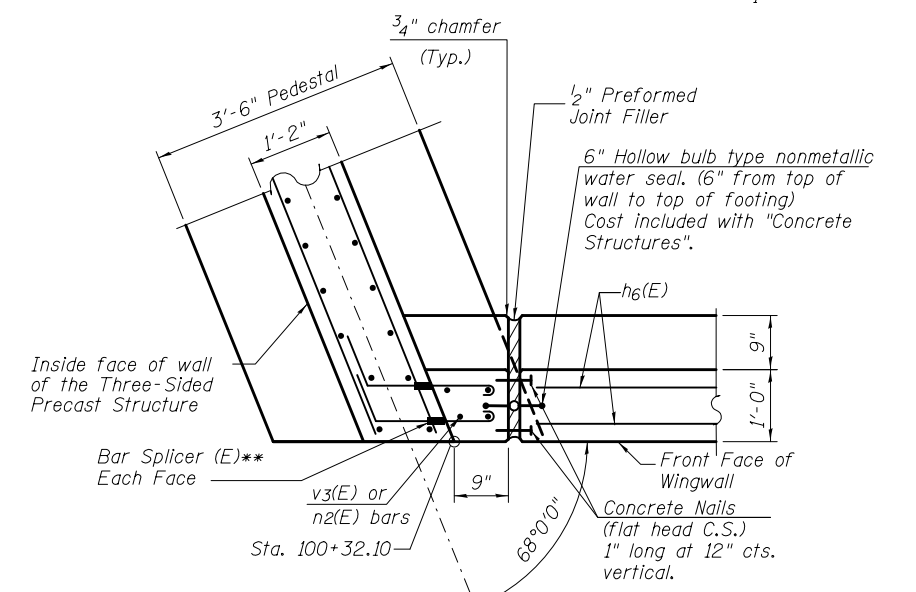

DETAIL C

** Bend Bar Splicer (E) in field. Cost included with "Three-Sided Precast Concrete Structures, 28'x10'".



USER NAME =	DESIGNED - JPM	REVISED -
PLOT SCALE =	CHECKED - JXH	REVISED -
PLOT DATE =	DRAWN - MPS	REVISED -
	CHECKED - JPM/JXH/TPG	REVISED -

STATE OF ILLINOIS
DEPARTMENT OF TRANSPORTATION

WINGWALL DETAILS
STRUCTURE NO. 022-3054 STA. 100 + 00.15

SHEET NO. S11 OF S13 SHEETS

F.A.P. RTE.	SECTION	COUNTY	TOTAL SHEETS	SHEET NO.
870	534R-B	DUPAGE	53	40
CONTRACT NO. 60M83				

DATE: AUGUST 03, 2012 ILLINOIS FED. AID PROJECT