**STRUCTURE GEOTECHNICAL REPORT
CIRCLE INTERCHANGE RECONSTRUCTION
EAST NORTH RAMP BRIDGE OVER
INTERSTATE 90/94
EXISTING SN 016-2453, PROPOSED SN 016-1712
FAI 90/94/290, SECTION 2014-005R&B
IDOT D-91-227-13, PTB 163/ITEM 001
COOK COUNTY, ILLINOIS**

**For
AECOM
303 East Wacker Drive
Chicago, IL 60601
(312) 938-0300**

**Submitted by
Wang Engineering, Inc.
1145 North Main Street
Lombard, IL 60148
(630) 953-9928**

**Original: June 13, 2017
Revised: September 1, 2017**

Technical Report Documentation Page

1. Title and Subtitle Structure Geotechnical Report Circle Interchange Reconstruction East North Ramp Bridge over Interstate 90/94		2. Report Date September 1, 2017
		3. Report Type <input checked="" type="checkbox"/> SGR <input type="checkbox"/> RGR <input type="checkbox"/> Draft <input checked="" type="checkbox"/> Final <input checked="" type="checkbox"/> Revised
4. Route / Section / County FAI 90/94/290 / 2014-005 R&B / Cook		5. IDOT Project Number(s) Job D-91-227-13
6. PTB / Item No. 163/001	7. Existing Structure Number(s) SN 016-2453	8. Proposed Structure Number(s) SN 016-1712
9. Prepared by Wang Engineering, Inc. 1145 N Main Street Lombard, IL 60148	Contributor(s) Author: Metin W. Seyhun, P.E. QC/QA: Mohammed Kothawala, P.E., D.GE. PIC: Corina T. Farez, P.E., P.G.	Contact Phone Number (630) 953-9928, Ext. 1018 mseyhun@wangeng.com
10. Prepared for AECOM 303 E Wacker Drive Chicago, IL 60601	Design / Structural Engineer Dr. Moussa A. Issa, S.E.	Contact Phone Number (708) 236-0900
11. Abstract <p>The existing, eight-span ramp EN carrying traffic from Eastbound Interstate 290 to Northbound Interstate 90/94 (F.A.I. Route 90/94/290) will be removed and replaced with a new, three-span structure with open abutments and multi-column piers. The bridge will have a back-to-back length of 298.65 feet and an out-to-out width of 49.17 feet.</p> <p>The existing embankments encountered at the locations of the proposed abutments are made up of stiff to hard, silty clay loam and silty loam fill. Beneath the fill, the borings encountered about 25 to 40 feet of very soft to medium stiff clay overlying stiff to hard silty clay. The deeper foundation soils include medium dense to dense gravelly sand and very dense silty loam resting on top of strong, fair to good quality dolostone, which was encountered about 90 to 100 feet below existing grade. The site classifies in the Seismic Class D and is in Seismic Performance Zone 1.</p> <p>New MSE retaining walls, in various combinations of cut and fill, will be constructed to support the approach embankments behind both abutments. The approach pavement settlement and global stability will depend on the type, height, and geometry of these new retaining walls; these issues will be discussed in separate retaining wall SGRs.</p> <p>The proposed abutments and piers could be supported on drilled shafts founded in the very dense silty loam (hardpan) or socketed into the bedrock. For shafts founded in hardpan, we estimate factored resistance of 215 to 855 kips for 3 to 6-foot diameter bases. For rock sockets 3 to 4-foot diameter, we estimate factored resistance of 2,300 to 4,080 kips. Alternatively, micropiles may also be used to support the substructures where there is low headroom. The abutment drilled shafts will require downdrag load allowances. The shafts will likely require means and methods, such as casing or drilling fluid, to protect against squeezing and groundwater infiltration immediately above the bedrock.</p> <p>The design of these excavation systems should include the pay item <i>Temporary Soil Retention System</i>. The selection of foundation type for the substructures should be based on the estimated loads and construction costs. The shafts near bedrock would likely require casing to protect against groundwater infiltration.</p>		
12. Path to archived file S:\Netprojects\11000401\Reports\Circle Structures\1712\RPT_Wang_MWS_11000401FinalENRampBridge1712_20170901.pdf		

TABLE OF CONTENTS

1.0 INTRODUCTION	1
1.1 PROPOSED STRUCTURE	1
1.2 EXISTING STRUCTURE.....	2
2.0 SITE CONDITIONS AND GEOLOGICAL SETTING	2
2.1 PHYSIOGRAPHY	2
2.2 SURFICIAL COVER	3
2.3 BEDROCK	3
3.0 METHODS OF INVESTIGATION	4
3.1 SUBSURFACE INVESTIGATION	4
3.2 LABORATORY TESTING.....	4
4.0 RESULTS OF FIELD AND LABORATORY INVESTIGATIONS.....	5
4.1 SOIL CONDITIONS	5
4.2 GROUNDWATER CONDITIONS.....	7
4.3 SEISMIC DESIGN CONSIDERATIONS	7
5.0 FOUNDATION ANALYSIS AND RECOMMENDATIONS.....	8
5.1 APPROACH EMBANKMENTS AND SLABS	8
5.1.1 <i>Settlement</i>	8
5.1.2 <i>Global Stability</i>	9
5.2 STRUCTURE FOUNDATIONS.....	9
5.2.1 <i>Drilled Shafts</i>	9
5.2.2 <i>Micropiles</i>	13
5.2.3 <i>Lateral Loading</i>	13
5.3 STAGE CONSTRUCTION DESIGN RECOMMENDATIONS.....	15
6.0 CONSTRUCTION CONSIDERATIONS.....	15
6.1 SITE PREPARATION	15
6.2 EXCAVATION.....	15
6.3 FILLING AND BACKFILLING.....	15
6.4 EARTHWORK OPERATIONS.....	16
6.5 DRILLED SHAFTS	16

6.6	MICROPILES	17
7.0	QUALIFICATIONS	18
	REFERENCES	19
	EXHIBITS	
	1. <i>Site Location Map</i>	
	2. <i>Site and Regional Geology</i>	
	3. <i>Boring Location Plan</i>	
	4. <i>Soil Profile</i>	
	APPENDIX A	
	<i>Boring Logs</i>	
	APPENDIX B	
	<i>Laboratory Test Results</i>	
	APPENDIX C	
	<i>Type Size Location Plan</i>	

**STRUCTURE GEOTECHNICAL REPORT
CIRCLE INTERCHANGE RECONSTRUCTION
EAST NORTH RAMP BRIDGE OVER INTERSTATE 90/94
EXISTING SN 016-2453, PROPOSED SN 016-1712
FAI 90/94/290, SECTION 2014-005R&B
IDOT D-91-227-13, PTB 163/ITEM 001
COOK COUNTY, ILLINOIS
FOR
AECOM**

1.0 INTRODUCTION

This report presents the results of Wang Engineering, Inc. (Wang) subsurface investigation, laboratory testing, and geotechnical evaluations for the design and construction of a new Ramp EN bridge connecting Eastbound Interstate 290 (NB I-290) to Northbound Interstate 90/94 (SB I-90/94) within the Circle Interchange in Chicago, Cook County, Illinois. The structure is also identified as the Ramp EN over I-90/94. A *Site Location Map* is presented as Exhibit 1.

1.1 Proposed Structure

Wang understands HBM Engineering Group, in conjunction with AECOM, envisions a new, three-span structure supporting the interchange ramp as it swings south of I-290 and carries traffic over both directions of I-90/94. The structure will have stub-type abutments and multiple-column piers, supported on deep foundations. The bridge will have a back-to-back length of 298.65 feet; from west to east, the three spans will measure 119.0, 77.7, and 95.3 feet. The out-to-out bridge width will measure 49.2 feet to accommodate two 12-foot wide lanes, one 10-foot wide shoulder, one 12-foot wide shoulder, and two barriers.

The abutments will be constructed atop new approach embankments supported by retaining walls; the west approach embankment will be supported by MSE walls with Structure Numbers (SNs) 016-1807 and 016-1810, while the east approach and abutment will be supported by MSE walls with SNs 016-1811 and 016-1812. The abutments will be constructed in a combination of cut and fill sections due to the existing ramp and embankment configurations. We estimate the approach embankments will have maximum exposed heights of 20 feet (west) and 25 feet (east), measured from the base of the proposed retaining walls to the top of the proposed abutments. Pier excavations will require *Temporary Soil Retention Systems*.

The TSL dated April 19, 2017 is shown in the *Type Size Location Plan* (Appendix C).

The purpose of our investigation was to characterize the site soil and groundwater conditions, perform geotechnical analyses, and provide recommendations for the design and construction of the foundations.

1.2 Existing Structure

The proposed structure is a realignment of SN 016-2453. The west abutment will be shifted to the southwest and the new ramp will cross the alignment of the existing ramp at approximately SB I-90/94. After the crossing, the new ramp bridge continues and terminates north of the existing east abutment. The site is currently a system of numerous ramps, embankments, and expressways that are scheduled for complete renovation. The west end of the bridge site is a series of SB I-90/94 entrance ramps, while the east end of the proposed site is currently the NB I-90/94 to EB I-290 ramp.

2.0 SITE CONDITIONS AND GEOLOGICAL SETTING

The site is located within the City of Chicago. On the USGS *Chicago Loop 7.5 Minute Series* map, the bridge is located in the NW¹/₄ of Section 16, Tier 39 N, Range 14 E of the 3rd Principal Meridian.

The following review of published geologic data, with emphasis on factors that might influence the design and construction of the proposed engineering works, is meant to place the project area within a geological framework and confirm the dependability and consistency of the present subsurface investigation results. For the study of the regional geologic framework, Wang considered northeastern Illinois in general and Cook County in particular. Exhibit 2 illustrates the *Site and Regional Geology*.

2.1 Physiography

The site is situated within the northern section of the Chicago/Calumet lacustrine plain (Chrzatowsky and Thompson 1992). The flat, lakeward-sloping surface is a wave-scoured groundmoraine covered by thin and discontinuous offshore lacustrine silt and clay (Willman 1971).

At the proposed bridge location, a number of existing ramps cross the alignment, converging and diverging with I-90/94. The elevation along the existing ramps varies between about 588 to 592 feet, whereas I-90/94 was constructed within a minor cut to an elevation of about 578 feet.

2.2 Surficial Cover

Within the project area, a more than 75-foot thick, Wisconsin-age glacial drift covers the bedrock (Leetaru et al. 2004). The glacial cover is made up of clay and silt of the Equality Formation of the Mason Group and diamictons of the Wadsworth and Lemont Formations of the Wedron Group (Hansel and Johnson 1996). The Equality Formation is made up of bedded silt and clay, locally laminated, with lenses and/or thin beds of sand and gravel. The Wadsworth Formation consists of relatively homogenous, massive, gray till with clay to silty clay matrix, with dolostone and shale clasts and occasional lenses of sorted and stratified silt. The Wadsworth Formation is underlined by the pebbly silty clay loam to silty loam diamicton of the Yorkville Member of the Lemont Formation, known informally as the Chicago “hardpan.”

The Equality Formation is characterized by low strength, medium to high plasticity, and medium to high moisture content. The underlying Wadsworth Formation is characterized by low plasticity, medium to low moisture content, medium to very stiff consistency, poor permeability, and low compressibility. The Yorkville Member is characterized by low plasticity, high blow counts, and low moisture content (Bauer et al. 1991; Peck and Reed 1954).

2.3 Bedrock

In the project area, the glacial deposits rest unconformably over a 350-foot thick Silurian-age dolostone. The top of bedrock may be encountered at elevations between 485 and 495 feet or 75 to 100 feet below ground surface (bgs). The Silurian dolostone dips gently eastward at a pace of 15 feet per mile. Only inactive faults are known in the area, and the seismic risk is minimal (Leetaru et al. 2004; Willman 1971). There are no records of mining activity in the area, but deep tunnel excavations are known to exist throughout the Circle Interchange area.

Our subsurface investigation results fit into the local geologic context. The borings drilled in the project area revealed the native sediments consist of clay to silty clay diamicton of the Wadsworth Formation resting on top of more competent silty clay loam diamicton (hardpan) of the Lemont Formation, which in turn is underlain by bedrock. Sound dolostone bedrock was sampled or inferred at depths deeper than 85.0 feet bgs or 486.0 to 493.0 feet elevation, within or close to the

range predicted based on published geological data.

3.0 METHODS OF INVESTIGATION

The following sections outline the subsurface and laboratory investigations performed by Wang. All elevations in this report are based on North American Vertical Datum (NAVD) 1988.

3.1 Subsurface Investigation

The subsurface investigation, performed by Wang in October 2013, consisted of seven structure borings, designated as 1712-B-01, 1712-B02, 1705-B-06A, 18-RWB-01, 19-RWB-01, 20-RWB-01, and 21-RWB-03. The borings were drilled from the shoulder and median areas of the existing interchange from elevations of 577.1 to 592.0 feet to depths of 75 to 112 feet bgs. Northings and eastings were surveyed by Wang with a mapping-grade GPS unit, whereas elevations, stations, and offsets were provided by AECOM. The boring locations are presented in the *Boring Logs* (Appendix A) and in the *Boring Location Plan* (Exhibit 3).

A truck-mounted drilling rig, equipped with solid or hollow stem augers and mud rotary equipment, was used to advance and maintain an open borehole. Soil sampling was performed according to AASHTO T 206, "*Penetration Test and Split Barrel Sampling of Soils*." The soil was sampled at 2.5-foot intervals to 30 feet bgs and at 5-foot intervals thereafter. Samples collected from each interval were placed in sealed jars for further examination and testing. NWD4-size bedrock cores were collected from Boreholes 1712-B-01, 1712-B-02, and 1705B-06A in 10-foot runs.

Field boring logs, prepared and maintained by a Wang engineer, include lithological descriptions, visual-manual soil classifications (IDH Textural Classification), results of Rimac and/or pocket penetrometer unconfined compressive strength tests, and results of Standard Penetration Tests (SPT) recorded as blows per 6 inches of penetration. The bedrock cores were described and measured for recovery and Rock Quality Designation (RQD).

Groundwater observations were made during and at the end of drilling operations. The boreholes were grouted immediately upon completion.

3.2 Laboratory Testing

All soil samples were tested in the laboratory for moisture content (AASHTO T-265). Atterberg limits

(AASHTO T 89/T 90) and particle size (AASHTO T 88) analyses were performed on selected samples. Field visual descriptions of the soil samples were verified in the laboratory, and the tested samples were classified in accordance with the IDH Textural Classification chart. Selected rock core samples were tested for unconfined compressive strength (ASTM D7012). Laboratory test results are shown in the *Boring Logs* (Appendix A) and in the *Laboratory Test Results* (Appendix B).

The soil and rock core samples will be retained in our laboratory for 60 days following IDOT approval of this report. The samples will be discarded unless a specific written request is received as to their disposition.

4.0 RESULTS OF FIELD AND LABORATORY INVESTIGATIONS

Detailed descriptions of the soil conditions encountered during the subsurface investigation are presented in the attached *Boring Logs* (Appendix A) and in the *Soil Profile* (Exhibit 4). Please note that strata contact lines represent approximate boundaries between soil types. The actual transition between soil types in the field may be gradual in horizontal and vertical directions.

4.1 Soil Conditions

The EN Ramp investigation sampled the existing I-90/94 shoulder, the existing EB I-290 to NB I-90/94 ramp, and the existing NB I-90/94 to EB I-290 ramp pavements. The pavement sections include either 13.5 inches of concrete over 4 to 4.5 inches of asphalt base, or 2 inches of asphalt pavement over a 10-inch thick concrete. The borings drilled off the roadways encountered 4 to 6 inches of black, silty loam topsoil.

In descending order, the general lithological succession encountered beneath pavement or topsoil includes 1) man-made ground (fill); 2) very soft to medium stiff clay to silty clay; 3) stiff to hard silty loam and silty clay loam; 4) medium stiff to very stiff clay; 5) medium dense to dense gravelly sand and silt; 6) very dense silty loam; and 7) strong, fair to good quality dolostone.

(1) Man-made ground (fill)

The existing embankments are made up of about 5 feet of mostly of stiff to hard, brown and black silty clay loam to silty loam fill. The fill has unconfined compressive strength (Qu) values of 1.2 to greater than 4.5 tsf with an average of 3.0 tsf and moisture content values of 6 to 21% with an average of 17%. The existing I-90/94 roadway, which is the lowest point along the proposed alignment, was constructed

within a minor cut and is not supported on fill material.

(2) Very soft to medium stiff clay to silty clay

At elevations of about 575 to 580 feet, the fill rests on top of about 30 to 45 feet of very soft to medium stiff, gray clay to silty clay. The top 8 to 10 feet of this layer has an average Q_u value of about 0.5 tsf and moisture content values averaging 19 to 20%. The middle 20 to 25 feet is very soft, with Q_u averaging less than 0.3 tsf and moisture content values averaging 27 to 28%. The bottom 10 to 15 feet grades back to medium stiff, with an average Q_u value of 0.5 tsf and moisture content value of about 21%.

Laboratory index testing on samples of this material shows liquid limit (L_L) values of 31 to 35% and plastic limit (P_L) values of 16 to 18%.

(3) Stiff to hard silty clay

The very soft to medium stiff clay to silty clay is underlain by approximately 15 feet of stiff to hard, gray silty clay to silty clay loam. The Q_u values range between 1.5 and 6.2 tsf with an average of 3.5 tsf, and moisture content values range from 13 to 21% with an average of 17%. The L_L values measured between 25 and 27% with P_L values of 16%.

(4) Medium stiff to very stiff clay

At an elevation of about 525 feet, the borings encountered a thin, 5 to 7-foot thick layer of clay with noticeable higher moisture content and lower Q_u values. This material was generally only encountered in a single split-spoon sample, but it is an important component of the subsurface profile due to its greater estimated deformability than the harder material directly above. This soil has Q_u values of 0.5 to 2.6 tsf and moisture content values of 21 to 30%; index testing shows L_L values of 36 to 44% and P_L values of 18 to 20%. We recommend deep foundations extend below this layer.

(5) Medium dense to dense gravelly sand and silt

At an elevation of about 516 to 510 feet, the borings advanced through 5 to 8 feet of medium dense to dense, gray gravelly sand and silt. This layer has SPT N-values of 15 blows/foot to greater than 50 blows/6 inches. Since the gravelly sand was encountered in a wet or saturated state advancing uncased drilled shaft foundations through this water-bearing soil may be problematic.

(6) Very dense silty loam

Underneath the sandy gravel outwash, the borings revealed very dense, gray silty loam and hard silty clay loam (hardpan). Sampling through the very dense soil resulted primarily in spoon refusal, with some samples having N-values recorded at 46 to 74 blows/foot. The samples that could be field tested for Q_u values show up to 9.5 tsf. Moisture content values are almost exclusively below 15%.

7) Strong dolostone bedrock

Borings 1712-B-01, 1712-B-02, and 1705-B-06A confirmed the top of sound bedrock at elevations of 487 to 493 feet with 10-foot long bedrock cores. Borings 19-RWB-01 and 20-RWB-01 encountered apparent top of bedrock at elevations of 487 to 495 feet. The coring revealed strong dolostone of fair to good rock quality having RQD values of 62 to 88%. The top 1 to 2 feet is considered weathered bedrock. Strength testing on cores from Boring 1705-B-06A measured uniaxial compressive strength values of 7,300 to 9,800 psi.

GSI values were determined were determined by Wang engineering geologist considering the rock mass structure and surface conditions of discontinuities of rock cores taken from Borings 1712-B-01, 1712-B-02, and 1705-B-06A. GSI values ranged from 48 to 58 for all the rock cores with an average value of 53. Bedrock core photographs are shown in Appendix A.

4.2 Groundwater Conditions

Groundwater may be perched within the water-bearing granular soils. This was observed at various levels in the saturated/wet samples of sand, silt, sandy loam and gravelly sand taken from Borings 1714-B-01 (at 516.5 and 496.2 feet), 1714-B-03 (at 510.9 feet) and 1714-B-04 (at 523.2, 518.2 and 498.2). The possibility of these layers should be accounted for during the design and construction of the foundations.

4.3 Seismic Design Considerations

The seismic site class has been determined in accordance with the IDOT *All Geotechnical Manual Users (AGMU) 9.1* method of analysis. The soils within the top 100 feet have a weighted average S_u of 1.04 ksf (AASHTO 2012; Method C controlling), and the results classify the site in the Seismic Site Class D in accordance with the IDOT method. The analysis has been performed for shaft foundations with minimum diameters of 36 inches. Smaller diameter shafts or driven piles may have more conservative seismic design parameters. The project location belongs to the Seismic Performance Zone 1. The seismic spectral acceleration parameters recommended for design in accordance with AASHTO

(2012) are summarized in Table 1. The factor of safety (FOS) against liquefaction for the bridge site is greater than the AASHTO-required value of 1.

Table 1: Seismic Design Parameters

Spectral Acceleration Period (sec)	Spectral Acceleration Coefficient ¹⁾ (% g)	Site Class Factors	Design Spectrum for Site Class D ²⁾ (% g)
0.0	PGA = 4.2	$F_{pga} = 1.6$	$A_s = 6.6$
0.2	$S_s = 9.0$	$F_a = 1.6$	$S_{DS} = 14.4$
1.0	$S_1 = 3.6$	$F_v = 2.4$	$S_{D1} = 8.5$

1) Base spectral acceleration coefficients from AASHTO (2012)

2) Site Class D values to be presented on plans ($A_s = PGA * F_{pga}$; $S_{DS} = S_s * F_a$; $S_{D1} = S_1 * F_v$)

5.0 FOUNDATION ANALYSIS AND RECOMMENDATIONS

Geotechnical evaluations and recommendations for the approach embankment, approach slab, and structure foundations are included in the following sections. New stub-type abutments are shown on the current TSL plan, dated April 19, 2017. We recommend supporting the abutments and piers on drilled shafts or micropiles. It is understood the design will be based on 2014 AASHTO LRFD Bridge Design Specification and IDOT 2012 Bridge Manual, and the TSL plan and final design will be done by HBM Engineering Group LLC (HBM).

5.1 Approach Embankments and Slabs

Wang will address settlement and global stability for the approach embankments and approach slabs in the individual retaining wall SGRs. We anticipate the fill sections required along the wall will undergo long-term consolidation settlements the walls will require ground improvement to meet the IDOT-required factor of safety (FOS) for global stability.

5.1.1 Settlement

The ramp grading behind the abutments will include significant changes by both cut and fill sections. We anticipate fill heights could reach as high as 25 feet above existing grade, and would induce long-

term consolidation settlement on the order of 6 to 10 inches with normal backfill. We anticipate the foundation soils will require improvement prior to fill placement; alternatively, lightweight fill and deep foundation options will also be explored. These evaluations will be provided in SGRs for the individual retaining walls.

Considering the higher degree of settlement anticipated at the abutments, there will be downdrag loads on the proposed abutments shafts and discussed in Section 5.2.1.

5.1.2 Global Stability

The retaining walls proposed along the approach embankments will likely require ground improvement to achieve an FOS of 1.5 against global instability. When updated ramp wall geometries are available, the slope stability analysis will be performed and the evaluations provided in the retaining wall SGRs.

5.2 Structure Foundations

Wang recommends supporting the abutments and piers on drilled shafts or micropiles. The shafts could be supported within the very dense silty loam or socketed into the bedrock. Due to noise and vibration concerns, we do not recommend the use of driven piles. Preliminary loads for the substructures have been provided by HBM and are summarized in Table 2.

Table 2: Summary of Preliminary Substructure Loads

Substructure ID	Service Dead Load (kips)	Service Live Load (kips)	Combined Service Load (kips)	Total Factored Load (kips)
West Abutment	630	252	882	1,259
Pier 1	1,417	476	1,893	2,675
Pier 2	983	423	1,406	2,024
East Abutment	482	231	713	1,033

5.2.1 Drilled Shafts

It is understood that both the abutments and pier 2 are proposed to be supported on drilled shaft, while pier 1 is proposed to be supported on micropiles. The borings encountered 15 feet or more of very dense silty loam below elevation of 515 feet. We recommend the shafts should be established

within this material (**Layer 6**). Alternatively, the shafts could be socketed into the bedrock encountered at an average elevation of about 490 feet. Shafts established within the silty loam should be temporarily cased to a minimum elevation of 515 feet to avoid construction issues associated with the water-bearing gravelly sand (**Layer 5**).

Drilled shafts should be designed (end bearing or side friction or both) as per IDOT 2012 bridge manual. Installing casing along the sides of the excavation will add uncertainty to the evaluation of mobilized skin friction; therefore, the shafts should be designed for end bearing only.

Shafts bearing on the hardpan should be designed for an end bearing resistance factor (ϕ_{stat}) of 0.55 in accordance with AASHTO (2014). The hardpan soil encountered above the bedrock has N60 values of more than 50 blows per foot and may be considered an IGM as per AASHTO (2014). We estimate the shafts will have a nominal unit base resistance in the very dense silty loam of 45 to 55 ksf and a factored unit base resistance of 25 to 30 ksf. The R_F , R_N , and estimated base elevations are summarized below in Table 3 for 3-, 4-, and 6-foot diameter base. We estimate the settlement of the shafts will be less than 0.5 inch.

Table 3: Estimated Resistances and Base Elevations for Shafts in Hardpan (IGM)

Structure Unit	Shaft Cap Base Elevations (feet)	Nominal Unit Base Resistance (ksf)	Base Diameter (feet)	Nominal Shaft Resistance, R_N (kips)	Factored Resistance Available, R_F (kips)	Total Shaft Length (feet)	Estimated Shaft Base Elevation (feet)
West Abutment (19-RWB-01)	586.64	55	3	390	215	81	506
			4	690	380	81	506
			6	1555	855	81	506
Pier 2 (1712-B-02)	575.07	45	3	320	176	69	506
			4	565	311	69	506
			6	1272	700	69	506
East Abutment	589.86	55	3	390	215	84	506

Structure Unit	Shaft Cap Base Elevations (feet)	Nominal Unit Base Resistance (ksf)	Base Diameter (feet)	Nominal Shaft Resistance, R_N (kips)	Factored Resistance Available, R_F (kips)	Total Shaft Length (feet)	Estimated Shaft Base Elevation (feet)
(1705-B-06A)			4	690	380	84	506
			6	1555	855	84	506

If the estimated bearing resistances for shafts established within the hardpan do not meet the loading criteria, the shafts may be established in rock sockets bearing upon sound bedrock. The bedrock cores show uniform, fair to good rock quality conditions, with sound, unfractured bedrock beginning about 2 feet below the top of weathered rock. We estimate the rock sockets will have diameters of 3.0 to 4.0 feet. Above the bedrock, the shafts should have diameters 6 inches larger than the sockets. Due to the possible presence of water-bearing granular materials above the bedrock, the shafts should have casings extending to the top of the rock.

We recommend designing the rock sockets based on the methods outlined in the 2014 AASHTO LRFD *Bridge Design Specifications*, that indicate the sockets should be designed for a geotechnical unit base resistance factor (ϕ_{stat}) 0.50 (AASHTO 2014). Based on this criterion, the R_F , R_N , and estimated base elevations for 3.0-, 3.5-, and 4.0- foot diameter sockets are summarized below in Table 4. We estimate the settlement of the rock sockets will be less than 0.5 inch.

The rock mass jointing and joint conditions were evaluated based on the geologic conditions in accordance with Hoek and Marinos (2000). The GSI values were determined by Wang considering the rock mass structure and surface conditions of discontinuities of rock cores taken from Borings 1712-B-01, 1712-B-02, and 1705-B-06A. GSI values ranged from 48 to 58 for all the rock cores with an average value of 53. A nominal unit base socket base resistance of 650 ksf was used for the design of East and West abutments and Pier 2. Pier 1 is proposed to be supported on micropiles.

Table 4: Estimated Resistances and Base Elevations for 3-foot Length Rock Socket Shafts**

Structure Unit	Shaft Cap Base Elevations (feet)	Top of Bedrock Elevation (feet)	Nominal Unit Socket Base Resistance (ksf)	Nominal Socket Resistance, R_N (kips)	Factored Resistance Available***, R_F (kips)	Total Socket Diameter (feet)	Estimated Total Shaft Length ¹ (feet)
West Abutment (1712-B-01) GSI - 52	586.64	490.5 (actual)*	650	4600	2300	3.0	99
			650	6260	3130	3.5	99
			650	8160	4080	4.0	99
Pier 2 (1712-B-02) GSI - 52	575.07	487.3 (actual)*	650	4600	2300	3.0	91
			650	6260	3130	3.5	91
			650	8160	4080	4.0	91
East Abutment (1705-B-06A/ 20-RWB-01) GSI - 52	589.86	486.0	650	4600	2300	3.0	107
			650	6260	3130	3.5	107
			650	8160	4080	4.0	107

* Actual top of sound bedrock from the nearest boring with bedrock cores. ** The 3-foot rock socket starts in sound bedrock, after any weathered bedrock.

*** Unit base resistance factor (ϕ_{sm}) 0.5 was used in accordance with Table 10.5.5.2.4-1, AASHTO 2014.

As indicated in Section 5.1.1, there will be downdrag load on the proposed abutment drilled shafts. We estimate the reduction for downdrag loads will be required to elevations 560 and 554 feet at the west and east abutments, respectively. The estimated nominal downdrag load for various shaft diameters are provided in Table 5.

Table 5: Estimated Downdrag Load for EN Ramp Bridge Abutments

Substructure Reference Boring	Shaft Diameter* (feet)	Nominal Downdrag Load (kips)
EN Ramp Bridge West Abutment 18-RWB-01	3.0	96
	3.5	112
	4.0	128
	4.5	144

Substructure Reference Boring	Shaft Diameter* (feet)	Nominal Downdrag Load (kips)
	5.0	161
	3.0	103
EN Ramp Bridge	3.5	120
East Abutment	4.0	140
20-RWB-01	4.5	154
	5.0	171

* Shaft diameter in the soil.

5.2.2 Micropiles

Micropiles are proposed to be used to support Pier 1 foundations due to the overlapping with the existing structure which will be in place at the time of construction. Micropiles cause minimal vibrations and noise, and can be installed in low headroom conditions. The contractor shall design, furnish, install and test micropiles in accordance with IDOT Special Provision GBSP No.85

Based on typical values provided in 2014 AASHTO Table C10.9.3.5.2-1 for the gravity-grouted (Type A) micropiles, we recommend using a nominal unit grout-to-ground (rock) bond resistance of 30 ksf. The estimated values may vary with actual rock conditions and installation procedures. Generally, a geotechnical resistance factor of 0.55 is considered for design; however, since IDOT Special Provision GBSP No.85 requires verification testing, the resistance factor can be raised as high as 0.7.

Tip resistance may be considered for the micropile bearing in rock. Based on the bedrock data, the bedrock nominal unit tip resistance of 650 ksf can be used for design. A geotechnical tip resistance factor of 0.5 should be considered for micropile axial capacity as per 2014 AASTHO Table 10.5.5.2.5-1.

Final design should be performed by a specialty contractor as per IDOT Special Provision GBSP No. 85 and submitted to the Engineer for review and approval.

5.2.3 Lateral Loading

Lateral loads on piles and shafts should be analyzed for maximum moments and lateral deflections.

Recommended lateral soil modulus and strain parameters required for analysis via the p-y curve method are included in Table 6 and rock parameters are included in Table 7.

Table 6: Recommended Soil Parameters for Lateral Load Analysis
 Borings 1705-B-06A and VST-06

Soil Type (Layer)	Unit Weight, γ (pcf)	Undrained Shear Strength, c_u (psf)	Estimated Friction Angle, ϕ ($^\circ$)	Estimated Lateral Soil Modulus Parameter, k (pci)	Estimated Soil Strain Parameter, ϵ_{50} (%)
M Dense to Dense LOAM FILL	125	0	33	60	--
V Stiff SILTY CLAY LOAM EL 586 to 580 feet	120	2500	0	1000	0.5
Soft to M. Stiff CLAY EL 580 to 566 feet	110	650	0	100	1.0
V. Soft CLAY EL 566 to 561 feet	110	500	0	100	1.5
Soft to M. Stiff CLAY EL 561 to 551 feet	110	650	0	100	1.0
M. Stiff CLAY EL 551 to 540 feet	115	900	0	100	1.0
Stiff to Hard SILTY CLAY EL 540 to 525 feet	125	4000	0	2000	0.4
V Stiff CLAY EL 525 to 518 feet	120	2500	0	1000	0.5
Loose SILT EL 518 to 515 feet	115	0	29	35	--
Hard SILTY CLAY EL 515 to 510 feet	125	8500	0	2000	0.4
V Dense to Hard SILTY LOAM EL 510 to 499 feet	125	4500	0	3000	0.3
V Dense SANDY GRAVEL EL 499 to 490 feet	125	0	36	125	--

Table 7: Recommended Rock Parameters for Lateral Load Analysis

Rock Type	Total Unit Weight, γ (pcf)	Young's Modulus (ksi)	Uniaxial Comp. Strength (ksi)	RQD (%)	Lateral Rock Modulus Parameter
Fair to Good Quality DOLOSTONE	135	2,500	7.5	70	0.0005

5.3 Stage Construction Design Recommendations

The existing bridge will be closed and traffic will be detoured during construction. Staging will not be required. At the abutments, if the soils cannot be sloped at a maximum grade of 1:2 (V:H), they should be supported by *Temporary Soil Retention Systems* designed by the Contractor and approved by IDOT prior to construction. New Piers 1 and 2 will be constructed adjacent to the expressways, and may require *Temporary Soil Retention Systems* at these locations. It is understood that the substructures will be constructed prior to the removal of the existing bridge (016-2453).

6.0 CONSTRUCTION CONSIDERATIONS

6.1 Site Preparation

All vegetation, surface topsoil, existing pavement, and debris should be cleared and stripped where foundations and structural fills will be placed.

The removal of existing structures shall be in accordance with IDOT Section 501, *Removal of Existing Structures* (IDOT 2016).

6.2 Excavation

Foundation excavations should be performed in accordance with local, state, and federal regulations. The potential effect of ground movements upon nearby utilities should be considered during construction.

6.3 Filling and Backfilling

Fill material required to attain the final design elevations should be structural fill material and should be pre-approved prior to placement. Compacted cohesive or granular soil conforming to IDOT Section

204 would be acceptable as structural fill (IDOT 2016). The fill material should be free of organic matter and debris. Structural fill should be placed in lifts and compacted according to IDOT Section 205, *Embankment* (IDOT 2016). The onsite fill materials could be considered as new fill material assuming it has an organic content lower than 10%. Ground improvement and lightweight fill materials will be discussed in the separate SGR for the retaining walls at the abutments.

Backfill materials must be pre-approved by the Resident Engineer. To backfill the piers we recommend the porous granular material conforming to the requirements specified in the IDOT Special Provision, *Granular Backfill for Structures* (IDOT 2016). Backfill material should be placed and compacted in accordance with the Special Provision.

It should be noted that if the structure needs to move laterally, an annulus will be needed for the abutment drilled shafts due to stiffness effect of a cellular concrete backfilled MSE wall. Lightweight cellular concrete fill should not be allowed to adhere to the drilled shafts during construction.

6.4 Earthwork Operations

The required earthwork can be accomplished with conventional construction equipment. Moisture and traffic will cause deterioration of exposed soils. Precautions should be taken by the Contractor to prevent water erosion of the exposed soils. A compacted grade will minimize water runoff erosion.

Earth moving operations should be scheduled to not coincide with excessive cold or wet weather (early spring, late fall, or winter). Any soil allowed to freeze or soften due to the standing water should be removed. Wet weather can cause problems with subgrade compaction.

It is recommended that an experienced geotechnical engineer be retained to inspect the exposed subgrade, monitor earthwork operations, and provide material inspection services during the construction phase of this project.

6.5 Drilled Shafts

The installation of drilled shafts through the water-bearing sand and gravelly sand frequently occurring (a) above the hard silty clay and/or (b) immediately atop of bedrock may present challenges. For the first case, the Contractor should be prepared to install casing or provide drilling fluid at each shaft location if the groundwater is encountered, most likely at about 520 to 510 feet elevation. For the second case, shafts socketed into the underlying bedrock, casing extending to the

top of bedrock elevation will be required to seal the excavation for coring. Failure to anticipate the challenges posed by the groundwater at this depth will result in caving or heaving sand and complicate bedrock coring operations. Prior to coring the bedrock, casing should be firmly seated into the top of the rock, and any drilling fluid removed to prevent caking of mud on the sides of the bedrock sockets. The shafts should be constructed in accordance with IDOT special provision.

In the event that permanent casing is not designed for the construction of drilled shaft socketed into bedrock, shafts structural integrity should be verified by Crosshole Sonic Logging (CSL). IDOT special provision “Crosshole Sonic Logging” dated March 9, 2010 or latest edition should be included in the specifications for inspection and testing of drilled shaft socketed into bedrock. Wang recommends providing CSL structural integrity testing for at least one drilled shaft per substructure.

Our analysis indicates that the shear strength of the soft clay at some locations may not be sufficient to resist squeeze into the drilled shafts. IDOT requires providing temporary casing through soft clay in order to properly construct the drilled shafts. The bottom of the soft clay elevation varies from 540.0 to 544 with an average of 542.0 feet. We recommend providing a second temporary casing to 540.0 (approximately two feet below the soft clay.) The following note should be shown on the plan.

“Based on the squeeze potential of the soft clay soils, the use of temporary casing will be required to two feet below soft clay (approximate Elevation 540.0 feet) in order to properly construct the drilled shafts. Casing may be pulled or left in place, as determined by the Contractor at no cost to the Department.”

6.6 Micropiles

The contractor shall perform final design, furnish, and install Micropiles in accordance with IDOT special provision.

7.0 QUALIFICATIONS

The analysis and recommendations submitted in this report are based upon the data obtained from the borings drilled at the locations shown on the boring logs and in Exhibit 3. This report does not reflect any variations that may occur between the borings or elsewhere on the site, variations whose nature and extent may not become evident until the course of construction. In the event that any changes in the design and/or location of the bridge are planned, we should be timely informed so that our recommendations can be adjusted accordingly.

It has been a pleasure to assist AECOM and the Illinois Department of Transportation on this project. Please call if there are any questions, or if we can be of further service.

Respectfully Submitted,

WANG ENGINEERING, INC. *Eng. 11/30/2017*

M. Seyhun
Metin W. Seyhun, P.E.
Senior Geotechnical Engineer

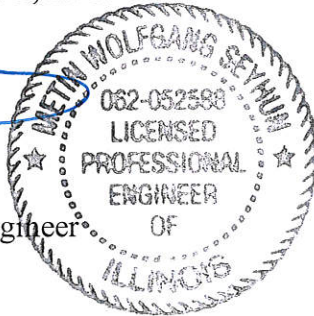

Corina T. Farez
Corina T. Farez, P.E., P.G.
Principal

REFERENCES

- AASHTO, 2014, LRFD Bridge Design Specifications: Washington, D.C., American Association of State Highway and Transportation Officials.
- BAUER, R.A., CURRY, B.B., GRAESE, A.M., VAIDEN, R.C., SU, W.J., and HASEK, M.J., 1991, Geotechnical Properties of Selected Pleistocene, Silurian, and Ordovician Deposits of Northeastern Illinois: Environmental Geology 139, Illinois State Geological Survey, 69 p.
- BROWN, D.A., TURNER, J.P., and CASTELLI, R.J., 2010, Drilled Shafts: Construction Procedures and LRFD Design Methods: Geotechnical Engineering Circular No. 10: Washington, D.C., Federal Highway Administration, 970 p.
- CBC (2016), Chapter 13-132, Foundations.
- FHWA-SA-97-070 (2000), Micropile Design and Construction Guidelines.
- HANSEL, A.K., and JOHNSON, W.H., 1996, Wedron and Mason Groups: Lithostratigraphic Reclassification of the Wisconsin Episode, Lake Michigan Lobe Area: ISGS Bulletin 104: Champaign, Illinois State Geological Survey, 116 p.
- IDOT, 2012, Bridge Manual, Illinois Department of Transportation.
- IDOT, 2016, Standard Specifications for Road and Bridge Construction, Illinois Department of Transportation, 1098 p.
- LEETARU, H.E., SARGENT, M.L., and KOLATA, D.R., 2004, Geologic Atlas of Cook County for Planning Purposes, Open File Series 2004-12, Illinois State Geological Survey, p. 30.
- PECK, R.B., and REED, W.C., 1954, Engineering Properties of Chicago Subsoils: University of Illinois Engineering Experiment Station Bulletin No. 423: Urbana, University of Illinois, 62 p.
- WILLMAN, H.B., 1971, Summary of the Geology of the Chicago Area, ISGS Circular C460: Urbana, Illinois State Geological Survey, p. 77.

EXHIBITS

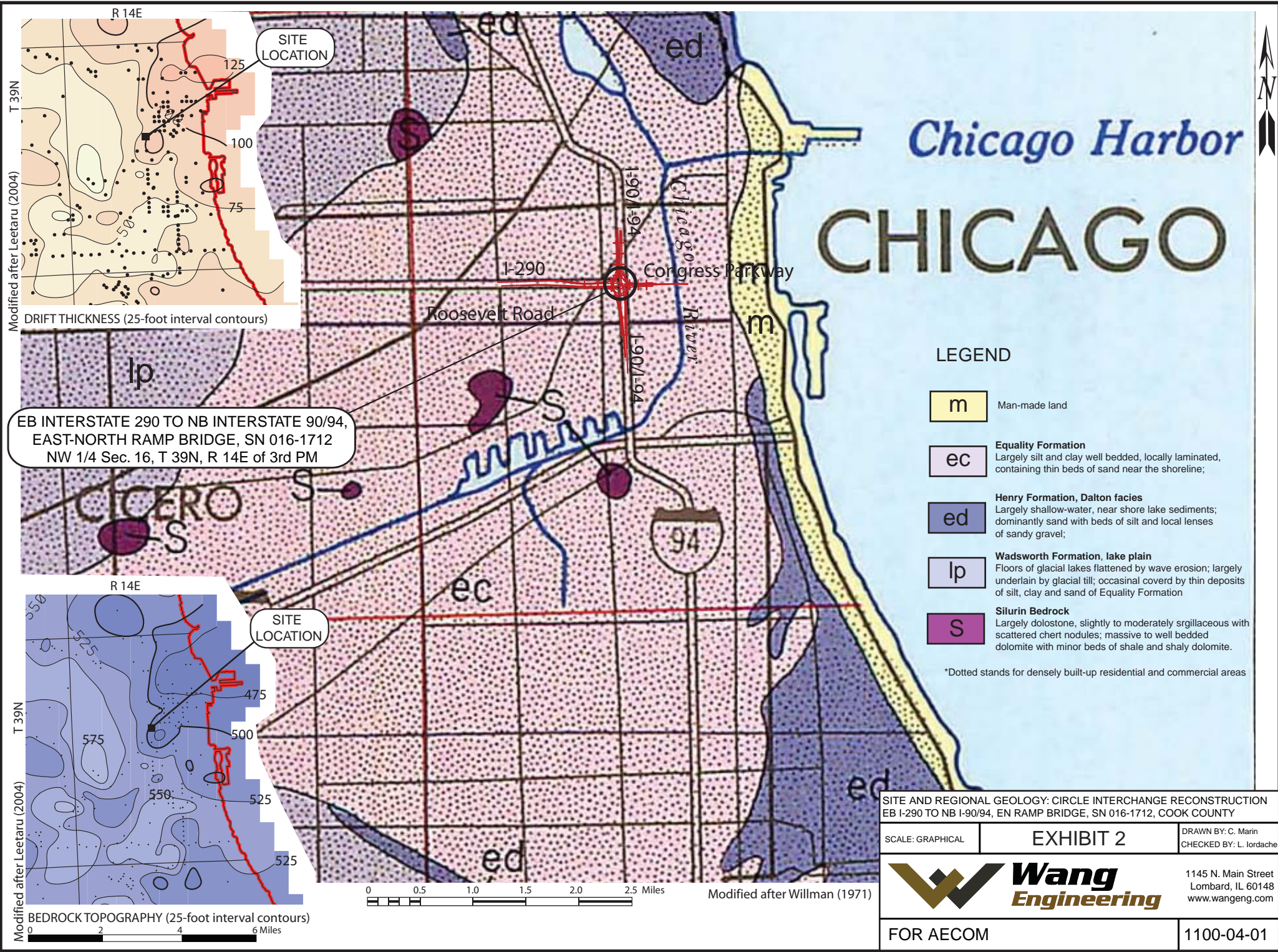

Modified after Leetaru (2004)

Modified after Leetaru (2004)

EB INTERSTATE 290 TO NB INTERSTATE 90/94,
EAST-NORTH RAMP BRIDGE, SN 016-1712
NW 1/4 Sec. 16, T 39N, R 14E of 3rd PM

Chicago Harbor

CHICAGO

LEGEND

- m** Man-made land
 - ec** Equality Formation
Largely silt and clay well bedded, locally laminated, containing thin beds of sand near the shoreline;
 - ed** Henry Formation, Dalton facies
Largely shallow-water, near shore lake sediments; dominantly sand with beds of silt and local lenses of sandy gravel;
 - lp** Wadsworth Formation, lake plain
Floors of glacial lakes flattened by wave erosion; largely underlain by glacial till; occasional covered by thin deposits of silt, clay and sand of Equality Formation
 - S** Silurin Bedrock
Largely dolostone, slightly to moderately argillaceous with scattered chert nodules; massive to well bedded dolomite with minor beds of shale and shaly dolomite.
- *Dotted stands for densely built-up residential and commercial areas

SITE AND REGIONAL GEOLOGY: CIRCLE INTERCHANGE RECONSTRUCTION
EB I-290 TO NB I-90/94, EN RAMP BRIDGE, SN 016-1712, COOK COUNTY

SCALE: GRAPHICAL	EXHIBIT 2	DRAWN BY: C. Marin CHECKED BY: L. Iordache
------------------	-----------	---

	1145 N. Main Street Lombard, IL 60148 www.wangeng.com
--	---

FOR AECOM	1100-04-01
-----------	------------

0 0.5 1.0 1.5 2.0 2.5 Miles

Modified after Willman (1971)

Modified after Leetaru (2004)

BEDROCK TOPOGRAPHY (25-foot interval contours)

0 2 4 6 Miles

Benchmark: Cut square on center of door entrance to 707 W. Harrison St. (south side of Harrison St., approx. 90' west of west line of Des Plaines St.). Elevation 597.47.

Existing Structure: S.N. 016-2453 was originally constructed in 1960 as an eight-span structure carrying one lane of traffic from eastbound I-290 to northbound I-90/94 (FAI Route No. 94; Section 0101.6-1P). Rehabilitation was performed under various contracts including removal and replacement of the Spans 1 thru 3 superstructure (from existing Bent 26 to Abutment 29), Piers 2 and 28, and the Abutment 29 backwall in 1987. The bridge has an overall length of approximately 429'-0" (41'-8 3/8" / 70'-5 3/8" / 53'-11 1/2" / 49'-0 5/8" / 54'-2 5/8" / 79'-5 13/16" / 40'-9 1/2" / 40'-0" spans), an overall width of 29'-0" (out-to-out superstructure) and consists of a minimum 7 1/2"-thick reinforced concrete deck with overlay supported on five (5) steel girders. The existing substructure consists of reinforced concrete piers and abutments on drilled shafts. This structure will be removed and replaced. Traffic will be detoured during construction.

HIGHWAY CLASSIFICATION	
Ramp EN	I-90/94 SB at Van Buren
Functional Class: Interstate	Functional Class: Interstate
ADT: 26,600 (2012); 31,000 (2040)	ADT: 100,100 (2012); 98,000 (2040)
ADTT: 1,032 (2012); 1,203 (2040)	ADTT: 11,351 (2012); 11,113 (2040)
DHW: 1,910 (2040)	DHW: 6,340 (2040)
Design Speed: 30 m.p.h.	Design Speed: 60 m.p.h.
Posted Speed: 30 m.p.h.	Posted Speed: 45 m.p.h.
One-Way Traffic	One-Way Traffic
Directional Distribution: 100%	Directional Distribution: 100%

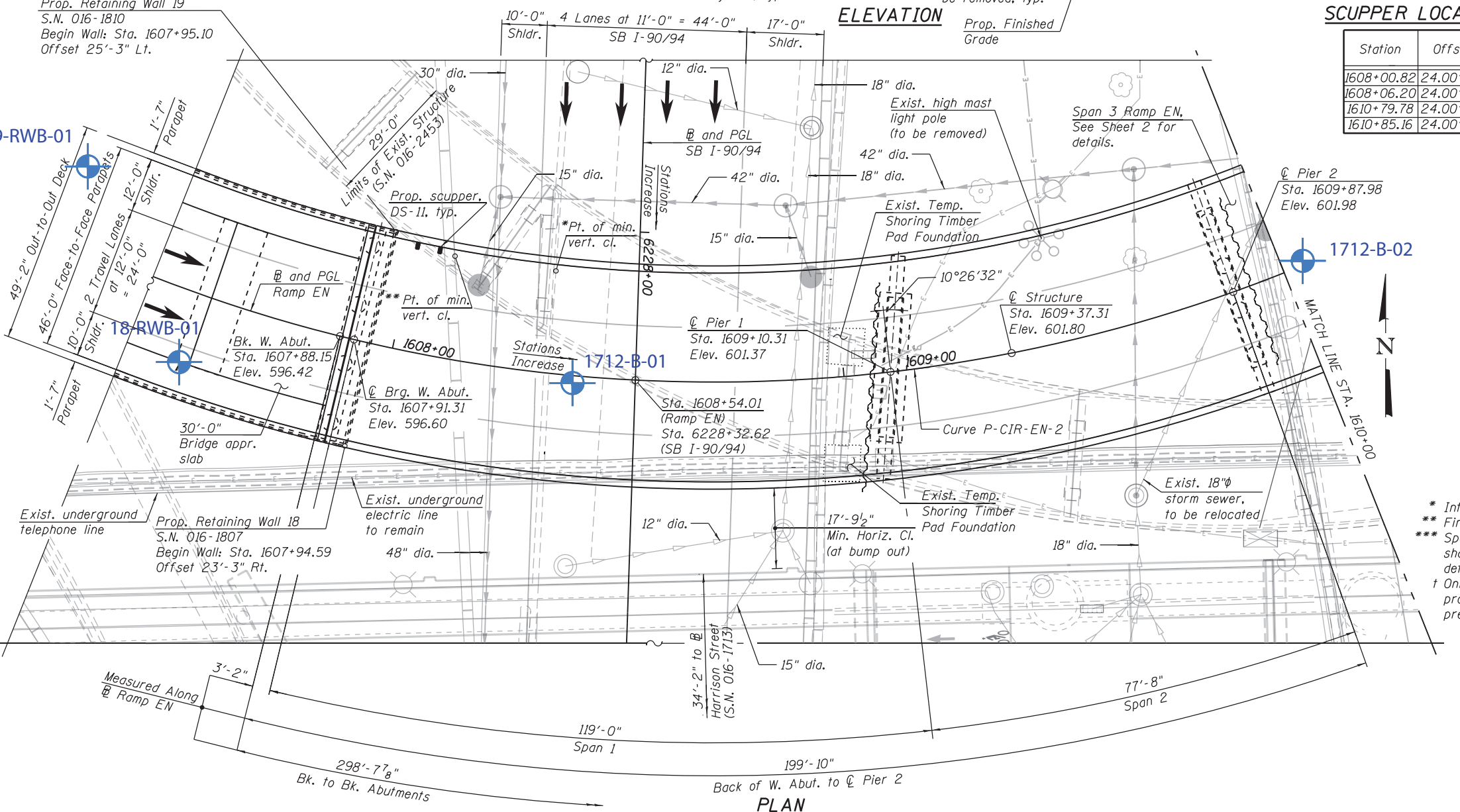
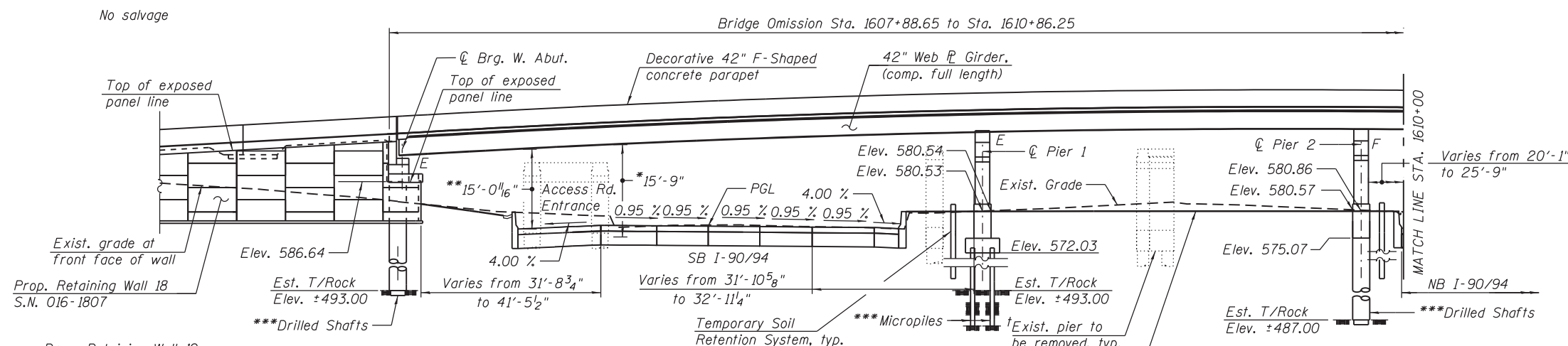

DESIGN SPECIFICATIONS
 2014 AASHTO LRFD Bridge Design Specifications, 7th Edition with 2015 and 2016 Interim Revisions

BORING LOCATION PLAN: CIRCLE INTERCHANGE RECONSTRUCTION EB I-290 BRIDGE TO NB I-90/94, EN RAMP BRIDGE, SN 016-1712

SCALE: GRAPHICAL **EXHIBIT 3-1** DRAWN BY: H Bista
 CHECKED BY: M. Seyhun

Wang Engineering
 1145 N. Main Street
 Lombard, IL 60148
 www.wangeng.com

FOR AECOM **1100-04-01**

SCUPPER LOCATION

Station	Offset
1608+00.82	24.00' Lt.
1608+06.20	24.00' Lt.
1610+79.78	24.00' Lt.
1610+85.16	24.00' Lt.

SEISMIC DATA

Seismic Performance Zone (SPZ) = 1
 Design Spectral Acceleration at 1.0 sec. (SD1) = 0.085g
 Design Spectral Acceleration at 0.2 sec. (SDS) = 0.144g
 Soil Site Class = D

LEGEND:

Soil Boring	Combined Sewer	Electric
Exist. High Mast Light Pole (to be removed)	Fiber Optic	Exist. Storm Sewer
Exist. Traffic Signal/Light Pole (to be removed)	Prop. Storm Sewer	Fire Hydrant
Junction Box	Water Line	Manhole
Telephone	Range 14E, 3rd P.M.	Proposed Structure

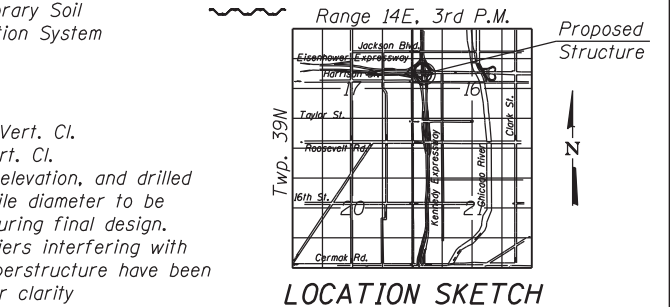

GENERAL PLAN & ELEVATION - 1
RAMP EN OVER F.A.I. RTE. 90/94
(DAN RYAN EXPRESSWAY)
F.A.I. RTE. 90/94/290 - SECTION 2014-005R&B
COOK COUNTY
STATION 1609+37.31
STRUCTURE NO. 016-1712

HBM ENGINEERING GROUP, LLC CONSULTING & DESIGN INSPECTION & RATING RESEARCH & TESTING 4415 WEST HARRISON ST. SUITE 231 HILLSIDE, IL 60162 PHONE: (708) 236-0900 FAX: (708) 236-0901	USER NAME = KenDrabant	DESIGNED - MI, JJS	REVISED -	STATE OF ILLINOIS DEPARTMENT OF TRANSPORTATION STRUCTURE NO. 016-1712	F.A.I. RTE. 90/94/290	SECTION 2014-005R&B	COUNTY COOK	TOTAL SHEETS 4	SHEET NO. 1		
	PLOT SCALE = 28x0' 1/4" = 1"	DRAWN - JJS, WM	REVISIONS -		SCALE:	SHEET 1 OF 4 SHEETS	STA.	TO STA.	ILLINOIS FED. AID PROJECT		
	PLOT DATE = 4/17/2017	CHECKED - MAI, MI	REVISIONS -		CONTRACT NO. 60X79						
		DATE - 04/19/2017	REVISIONS -								

HIGHWAY CLASSIFICATION

Ramp NW
 Functional Class: Interstate
 ADT: 32,500 (2012); 36,000 (2040)
 ADTT: 2,483 (2012); 2,730 (2040)
 DHV: 2,790 (2040)
 Design Speed: 35 m.p.h.
 Posted Speed: 35 m.p.h.
 One-Way Traffic
 Directional Distribution: N/A

I-90/94 NB at Van Buren
 Functional Class: Interstate
 ADT: 96,700 (2012); 81,000 (2040)
 ADTT: 11,217 (2012); 9,396 (2040)
 DHV: 4,780 (2040)
 Design Speed: 60 m.p.h.
 Posted Speed: 45 m.p.h.
 One-Way Traffic
 Directional Distribution: 100%

Ramp NE
 Functional Class: Interstate
 ADT: 3,100 (2012); 4,000 (2040)
 ADTT: 42 (2012); 55 (2040)
 DHV: 280 (2040)
 Design Speed: 30 m.p.h.
 Posted Speed: 30 m.p.h.
 One-Way Traffic
 Directional Distribution: NA

NB Bypass
 Functional Class: Interstate
 ADT: NA (2012); 17,000 (2040)
 ADTT: NA (2012); 442 (2040)
 DHV: 1,680 (2040)
 Design Speed: 30 m.p.h.
 Posted Speed: 30 m.p.h.
 One-Way Traffic
 Directional Distribution: NA

NOTES:

- For Profile Grade Lines and Offset Sketch, see Sheet 4 of 4.
 - Drainage scuppers shall be attached to a closed drainage system.
 - All structural steel shall be metalized (thermal spraying).
 - All substructure units are oriented 90° to \bar{E} unless noted otherwise.
 - The required lightweight fill and ground improvements for the MSE retaining walls at the abutments will be determined by the Geotechnical Engineer and incorporated into the TSL plans for the MSE retaining walls.
- * Interim Min. Vert. Cl.
 ** Final Min. Vert. Cl.
 *** Spacing, tip elevation and shaft diameter to be determined during final design.

BORING LOCATION PLAN: CIRCLE INTERCHANGE RECONSTRUCTION EB I-290 BRIDGE TO NB I-90/94, EN RAMP BRIDGE, SN 016-1712

SCALE: GRAPHICAL **EXHIBIT 3-2** DRAWN BY: H. Bista
 CHECKED BY: M. Seyhun

Wang Engineering
 1145 N. Main Street
 Lombard, IL 60148
 www.wangeng.com

FOR AECOM **1100-04-01**

LEGEND:

- Soil Boring
- Electric
- Fiber Optic
- Exist. Storm Sewer
- Prop. Storm Sewer
- Fire Hydrant
- Water Line
- Telephone
- Manhole
- Combined Sewer
- Exist. High Mast Light Pole (to be removed)
- Exist. Traffic Signal/Light Pole (to be removed)
- Junction Box

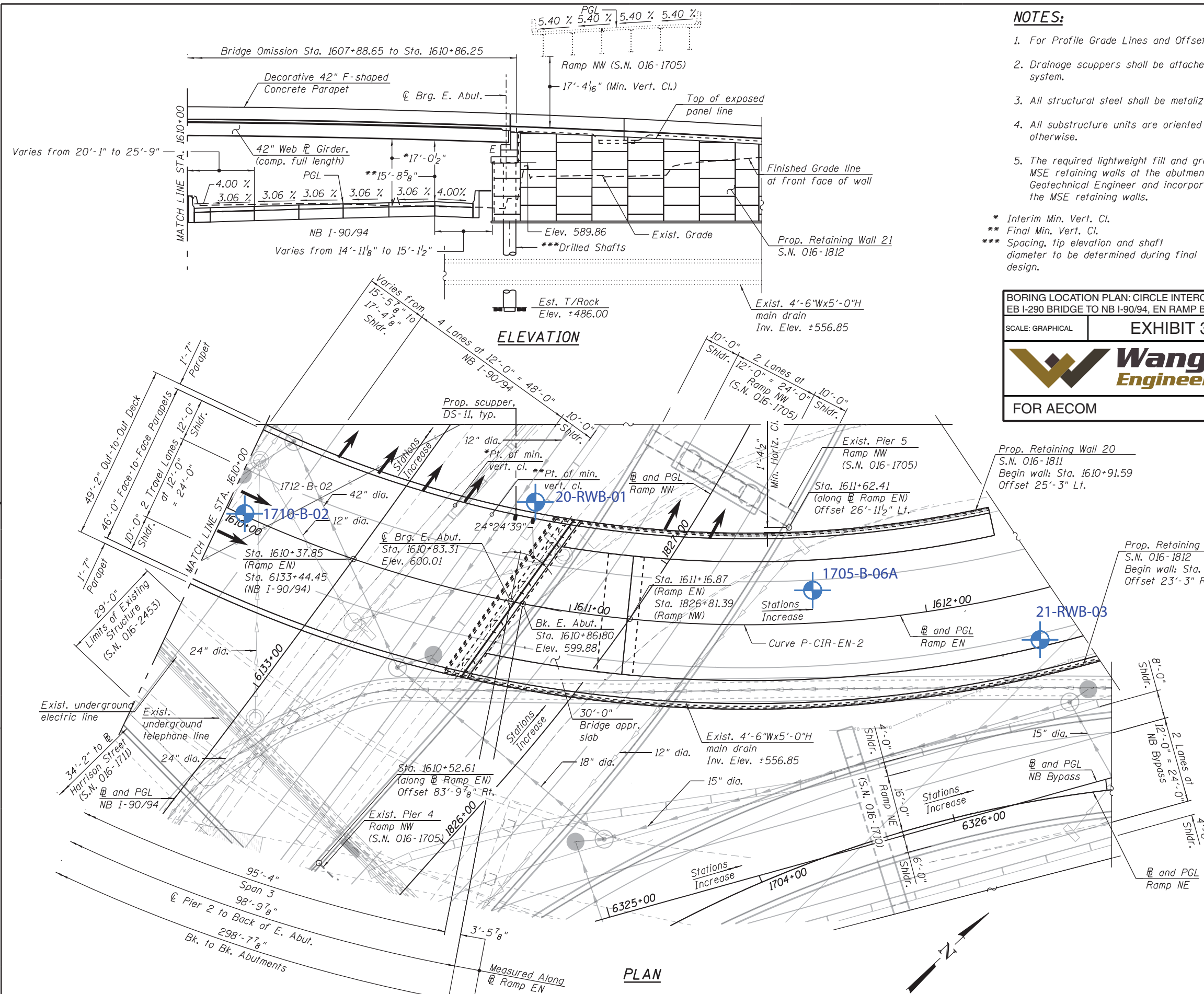

GENERAL PLAN & ELEVATION - 2
RAMP EN OVER F.A.I. RTE. 90/94
(DAN RYAN EXPRESSWAY)
F.A.I. RTE. 90/94/290 - SECTION 2014-005R&B
COOK COUNTY
STATION 1609+37.31
STRUCTURE NO. 016-1712

HBM
 ENGINEERING GROUP, LLC
 CONSULTING & DESIGN
 INSPECTION & TESTING
 RESEARCH & TESTING

USER NAME = KenDrabant	DESIGNED - MI, JJS	REVISED -
	DRAWN - JJS, WM	REVISED -
PLOT SCALE = 28:0' = 1" = 1/8"	CHECKED - MAI, MI	REVISED -
PLOT DATE = 4/17/2017	DATE - 04/19/2017	REVISED -

STATE OF ILLINOIS
DEPARTMENT OF TRANSPORTATION

STRUCTURE NO. 016-1712

SCALE: SHEET 2 OF 4 SHEETS STA. TO STA.

F.A.I. RTE. 90/94/290	SECTION 2014-005R&B	COUNTY COOK	TOTAL SHEETS 4	SHEET NO. 2
CONTRACT NO. 60X79			ILLINOIS FED. AID PROJECT	

FILE PATH = p:\161749-P\MINT\pccom\line\local\BDCM_D502_MIA\Documents\01_Americas\T\engor\station\60269938_Circle\Phase_1\000_CAD\008_Structure\161712-6000-000-TSL-002

WEI 11X17 11000401.GPJ_WANGENG.GDT 1/9/14

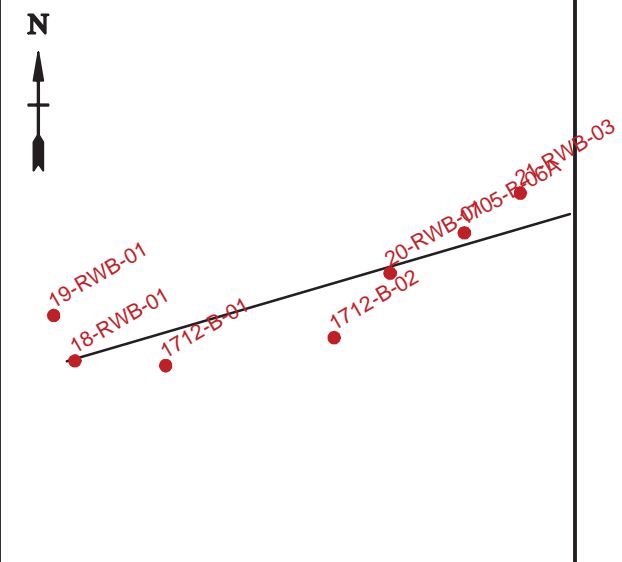
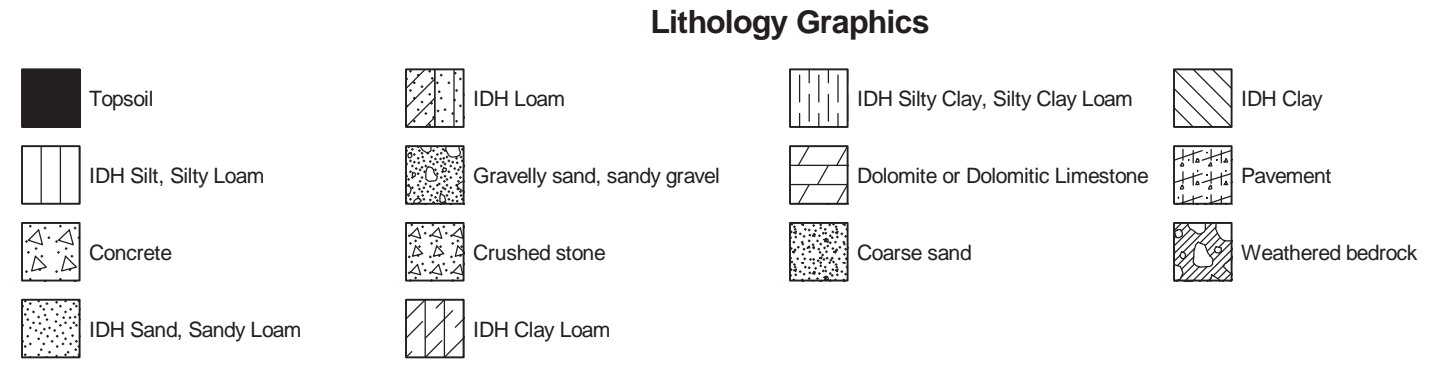
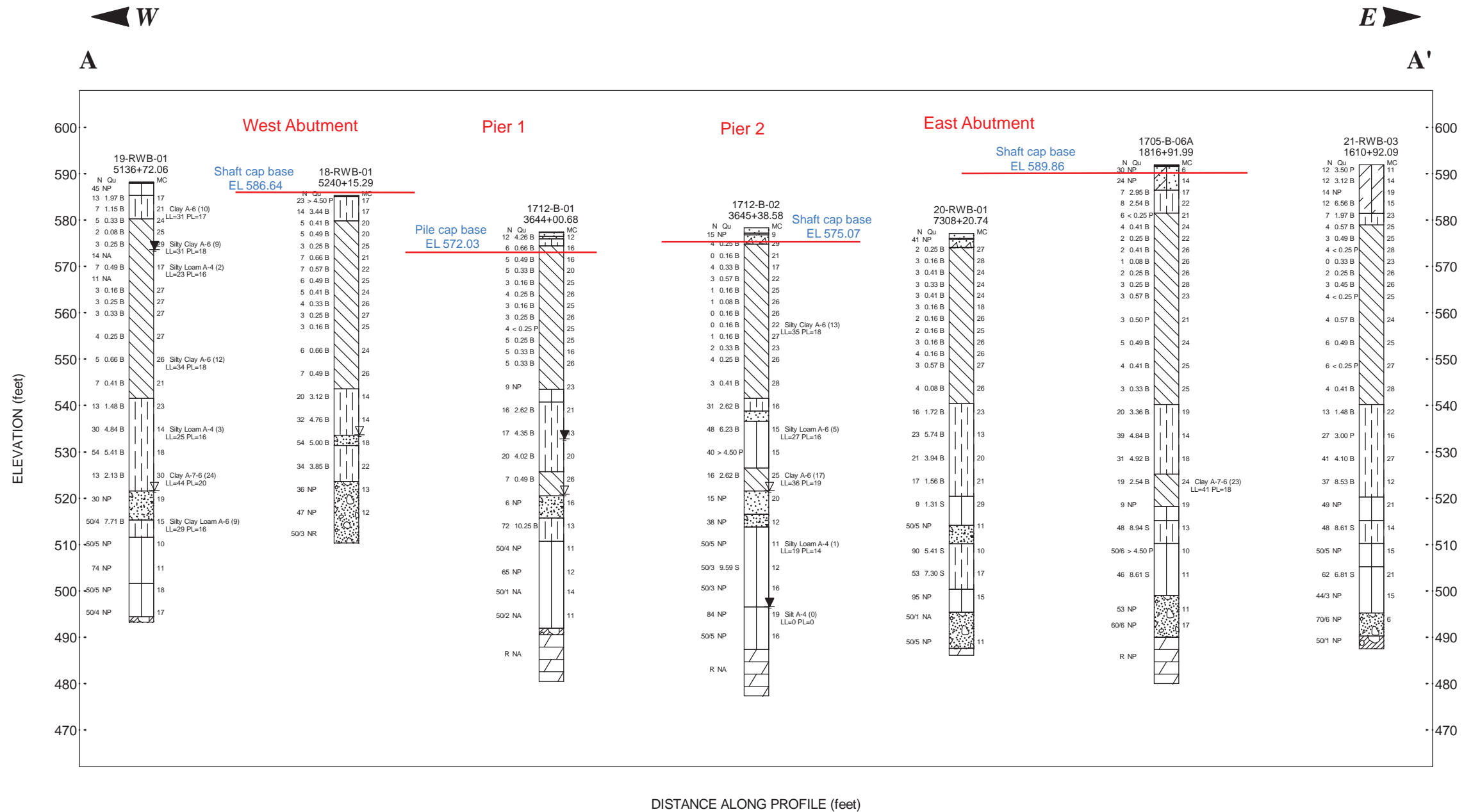

Site Map Scale 1 inch equals 185 feet

Explanation:

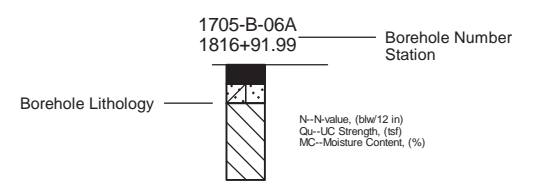

- Water Level Reading at time of drilling.
- Water Level Reading 24-hr after drilling or at end of drilling

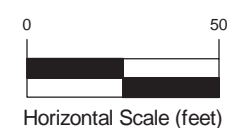

Vertical Exaggeration: 2x

Wang Engineering, Inc.
1145 N Main Street
Lombard, IL 60148

Soil Profile A-A'
EB I-290 to NB I-90/94
EN Ramp Bridge, SN 016-1712



Circle Interchange Reconstruction
Section 17, T39N, R14E of 3rd PM

JOB NUMBER	PLATE NUMBER
1100-04-01	EXHIBIT 4

APPENDIX A



wangeng@wangeng.com
 1145 N Main Street
 Lombard, IL 60148
 Telephone: 630 953-9928
 Fax: 630 953-9938

BORING LOG VST-06

WEI Job No.: 1100-04-01

Client: **AECOM**
 Project: **Circle Interchange Reconstruction**
 Location: **Section 17, T39N, R14E of 3rd PM**

Datum: NAVD 88
 Elevation: 585.69 ft
 North: 1898109.29 ft
 East: 1171902.18 ft
 Station: 1103+77.81
 Offset: 27.3835 RT

Profile	Elevation (ft)	SOIL AND ROCK DESCRIPTION	Depth (ft)	Sample Type recovery	Sample No.	SPT Values (blw/6 in)	Qu (tsf)	Moisture Content (%)	Profile	Elevation (ft)	SOIL AND ROCK DESCRIPTION	Depth (ft)	Sample Type recovery	Sample No.	SPT Values (blw/6 in)	Qu (tsf)	Moisture Content (%)
	580.2	Hard, brown SILTY CLAY LOAM, trace gravel --FILL--	5		1	7 6 6	4.50 P	16			--In-Situ Vane Shear, 20.5 feet-- --S _{u undis} = 775.4 psf-- --S _{u remold} = 360.4 psf-- --Sensitivity = 2.2--	5		5			
	576.7	Soft, gray SILTY CLAY LOAM	25		2	1 2 3	0.41 B	23			--In-Situ Vane Shear, 23.0 feet-- --S _{u undis} = 600.6 psf-- --S _{u remold} = 305.8 psf-- --Sensitivity = 2.0--	25		6			
			30		7						--In-Situ Vane Shear, 25.5 feet-- --S _{u undis} = 578.8 psf-- --S _{u remold} = 316.7 psf-- --Sensitivity = 1.8--	30		7			
			35		8						--In-Situ Vane Shear, 28.0 feet-- --S _{u undis} = 611.6 psf-- --S _{u remold} = 338.5 psf-- --Sensitivity = 1.8--	35		8			
			40		9						--In-Situ Vane Shear, 30.5 feet-- --S _{u undis} = 786.3 psf-- --S _{u remold} = 382.2 psf-- --Sensitivity = 2.1--	40		9			
					10						--In-Situ Vane Shear, 33.0 feet-- --S _{u undis} = 698.9 psf-- --S _{u remold} = 404.1 psf-- --Sensitivity = 1.7--			10			
					11						--In-Situ Vane Shear, 35.5 feet-- --S _{u undis} = 808.1 psf-- --S _{u remold} = 502.4 psf-- --Sensitivity = 1.6--			11			
					12						--In-Situ Vane Shear, 38.0 feet-- --S _{u undis} = 982.9 psf-- --S _{u remold} = 546.0 psf-- --Sensitivity = 1.8--			12			

GENERAL NOTES

Begin Drilling **12-09-2015** Complete Drilling **12-14-2015**
 Drilling Contractor **Wang Testing Services** Drill Rig **CME-55 TMR [85%]**
 Driller **R&N** Logger **F. Bozga** Checked by **A. Kurnia**
 Drilling Method **2.25" HSA to 10', mud rotary thereafter, boring backfilled upon completion**

WATER LEVEL DATA

While Drilling **Rotary wash**
 At Completion of Drilling **mud in the borehole**
 Time After Drilling **NA**
 Depth to Water **NA**

The stratification lines represent the approximate boundary between soil types; the actual transition may be gradual.

WANGENGINC 11000401.GPJ WANGENG.GDT 8/30/17



wangeng@wangeng.com
 1145 N Main Street
 Lombard, IL 60148
 Telephone: 630 953-9928
 Fax: 630 953-9938

BORING LOG VST-06

WEI Job No.: 1100-04-01

Client: **AECOM**
 Project: **Circle Interchange Reconstruction**
 Location: **Section 17, T39N, R14E of 3rd PM**

Datum: NAVD 88
 Elevation: 585.69 ft
 North: 1898109.29 ft
 East: 1171902.18 ft
 Station: 1103+77.81
 Offset: 27.3835 RT

Profile	Elevation (ft)	SOIL AND ROCK DESCRIPTION	Depth (ft)	Sample Type recovery	Sample No.	SPT Values (blw/6 in)	Qu (tsf)	Moisture Content (%)	Profile	Elevation (ft)	SOIL AND ROCK DESCRIPTION	Depth (ft)	Sample Type recovery	Sample No.	SPT Values (blw/6 in)	Qu (tsf)	Moisture Content (%)
		--In-Situ Vane Shear, 40.5 feet-- -- $S_{u\ undis}$ = 906.4 psf-- -- $S_{u\ remold}$ = 524.2 psf-- --Sensitivity = 1.7--	13	VS	13												
	542.2	--In-Situ Vane Shear, 43.0 feet-- -- $S_{u\ undis}$ = 677.1 psf-- -- $S_{u\ remold}$ = 393.1 psf-- --Sensitivity = 1.7-- Boring terminated at 43.50 ft	45	VS	14												
			50														
			55														
			60														

GENERAL NOTES

Begin Drilling **12-09-2015** Complete Drilling **12-14-2015**
 Drilling Contractor **Wang Testing Services** Drill Rig **CME-55 TMR [85%]**
 Driller **R&N** Logger **F. Bozga** Checked by **A. Kurnia**
 Drilling Method **2.25" HSA to 10', mud rotary thereafter, boring backfilled upon completion**

WATER LEVEL DATA

While Drilling ∇ **Rotary wash**
 At Completion of Drilling ∇ **mud in the borehole**
 Time After Drilling **NA**
 Depth to Water ∇ **NA**

The stratification lines represent the approximate boundary between soil types; the actual transition may be gradual.



wangeng@wangeng.com
 1145 N Main Street
 Lombard, IL 60148
 Telephone: 630 953-9928
 Fax: 630 953-9938

BORING LOG 1705-B-06A

WEI Job No.: 1100-04-01

Client: **AECOM**
 Project: **Circle Interchange Reconstruction**
 Location: **Section 17, T39N, R14E of 3rd PM**

Datum: NAVD 88
 Elevation: 591.98 ft
 North: 1897749.88 ft
 East: 1171805.18 ft
 Station: 1816+91.99
 Offset: 2.3899 LT

Profile	Elevation (ft)	SOIL AND ROCK DESCRIPTION	Depth (ft)	Sample Type recovery	Sample No.	SPT Values (blw/6 in)	Qu (tsf)	Moisture Content (%)	Profile	Elevation (ft)	SOIL AND ROCK DESCRIPTION	Depth (ft)	Sample Type recovery	Sample No.	SPT Values (blw/6 in)	Qu (tsf)	Moisture Content (%)	
	591.5	6-inch thick, black SILTY LOAM --TOPSOIL-- Medium dense to dense, brown LOAM, little gravel and brick fragments --FILL--			1	9 17 13	NP	6							0 0 1	0.08 B	26	
			5		2	2 15 9	NP	14				25		10	0 0 2	0.25 B	26	
	586.5	Very stiff, gray SILTY CLAY LOAM, trace gravel			3	2 3 4	2.95 B	17						11	0 0 3	0.25 B	28	
			10		4	2 4 4	2.54 B	22				30		12	0 1 2	0.57 B	23	
	581.5	Very soft to medium stiff, gray CLAY to SILTY CLAY, trace gravel			5	3 3 3	< 0.25 P	21										
			15		6	0 2 2	0.41 B	24				35		13	0 1 2	0.50 P	21	
					7	0 1 1	0.25 B	22										
			20		8	0 0 2	0.41 B	26				40		14	0 3 2	0.49 B	24	

GENERAL NOTES

Begin Drilling **07-25-2013** Complete Drilling **07-26-2013**
 Drilling Contractor **Wang Testing Services** Drill Rig **CME-55 TMR**
 Driller **R&J** Logger **A. Tomaras** Checked by **C. Marin**
 Drilling Method **2.25" SSA to 10', mud rotary thereafter, boring**
backfilled upon completion

WATER LEVEL DATA

While Drilling ∇ **NA**
 At Completion of Drilling ∇ **NA**
 Time After Drilling **NA**
 Depth to Water ∇ **NA**

The stratification lines represent the approximate boundary between soil types; the actual transition may be gradual.

WANGENGINC 11000401.GPJ WANGENG.GDT 1/9/14



wangeng@wangeng.com
 1145 N Main Street
 Lombard, IL 60148
 Telephone: 630 953-9928
 Fax: 630 953-9938

BORING LOG 1705-B-06A

WEI Job No.: 1100-04-01

Client **AECOM**
 Project **Circle Interchange Reconstruction**
 Location **Section 17, T39N, R14E of 3rd PM**

Datum: NAVD 88
 Elevation: 591.98 ft
 North: 1897749.88 ft
 East: 1171805.18 ft
 Station: 1816+91.99
 Offset: 2.3899 LT

Profile	Elevation (ft)	SOIL AND ROCK DESCRIPTION	Depth (ft)	Sample Type recovery	Sample No.	SPT Values (blw/6 in)	Qu (tsf)	Moisture Content (%)	Profile	Elevation (ft)	SOIL AND ROCK DESCRIPTION	Depth (ft)	Sample Type recovery	Sample No.	SPT Values (blw/6 in)	Qu (tsf)	Moisture Content (%)
			45		15	0 2 2	0.41 B	25				65		19	10 12 19	4.92 B	18
			50		16	1 1 2	0.33 B	25		525.2	Very stiff, gray CLAY, trace gravel	70		20	6 9 10	2.54 B	24
	540.2	Very stiff to hard, gray SILTY CLAY, trace gravel	55		17	6 7 13	3.36 B	19		518.2	Loose, gray SILT --Wet--	75		21	2 4 5	NP	19
			60		18	13 18 21	4.84 B	14		515.2	Hard, gray SILTY CLAY, trace gravel	80		22	13 20 28	8.94 S	13

GENERAL NOTES

Begin Drilling **07-25-2013** Complete Drilling **07-26-2013**
 Drilling Contractor **Wang Testing Services** Drill Rig **CME-55 TMR**
 Driller **R&J** Logger **A. Tomaras** Checked by **C. Marin**
 Drilling Method **2.25" SSA to 10', mud rotary thereafter, boring**
 **backfilled upon completion**

WATER LEVEL DATA

While Drilling ∇ **NA**
 At Completion of Drilling ∇ **NA**
 Time After Drilling **NA**
 Depth to Water ∇ **NA**

The stratification lines represent the approximate boundary between soil types; the actual transition may be gradual.

WANGENGINC 11000401.GPJ WANGENG.GDT 1/9/14



wangeng@wangeng.com
 1145 N Main Street
 Lombard, IL 60148
 Telephone: 630 953-9928
 Fax: 630 953-9938

BORING LOG 1705-B-06A

WEI Job No.: 1100-04-01

Client: **AECOM**
 Project: **Circle Interchange Reconstruction**
 Location: **Section 17, T39N, R14E of 3rd PM**

Datum: NAVD 88
 Elevation: 591.98 ft
 North: 1897749.88 ft
 East: 1171805.18 ft
 Station: 1816+91.99
 Offset: 2.3899 LT

Profile	Elevation (ft)	SOIL AND ROCK DESCRIPTION	Depth (ft)	Sample Type recovery	Sample No.	SPT Values (blw/6 in)	Qu (tsf)	Moisture Content (%)	Profile	Elevation (ft)	SOIL AND ROCK DESCRIPTION	Depth (ft)	Sample Type recovery	Sample No.	SPT Values (blw/6 in)	Qu (tsf)	Moisture Content (%)		
	510.2	Very dense to hard, gray SILTY LOAM to SILTY CLAY LOAM, trace gravel								490.0	Strong, fair to good rock quality, light gray, fresh, joint breaks with little to no infill, slightly vuggy DOLOSTONE with stylolites --Run 1 - RECOVERY=100%-- --RQD (top 5ft)=45%-- --RQD= (10ft)=62%--			26	60/6	NP	17		
			85		23	33 46 50/6	4.50 P	10											
				90		24	13 20 26	8.61 S	11							1		NP	
		--HARD DRILLING-- --Possible Cobbles--								480.0	Boring terminated at 112.00 ft								
	499.0	Very dense, SANDY GRAVEL, with rock fragments																	
				95		25	21 24 29	NP	11										
		--HARD DRILLING-- --Possible Cobbles--																	
			100																

GENERAL NOTES

Begin Drilling **07-25-2013** Complete Drilling **07-26-2013**
 Drilling Contractor **Wang Testing Services** Drill Rig **CME-55 TMR**
 Driller **R&J** Logger **A. Tomaras** Checked by **C. Marin**
 Drilling Method **2.25" SSA to 10', mud rotary thereafter, boring**
backfilled upon completion

WATER LEVEL DATA

While Drilling ∇ **NA**
 At Completion of Drilling ∇ **NA**
 Time After Drilling **NA**
 Depth to Water ∇ **NA**

The stratification lines represent the approximate boundary between soil types; the actual transition may be gradual.

WANGENGINC 11000401.GPJ WANGENG.GDT 1/9/14

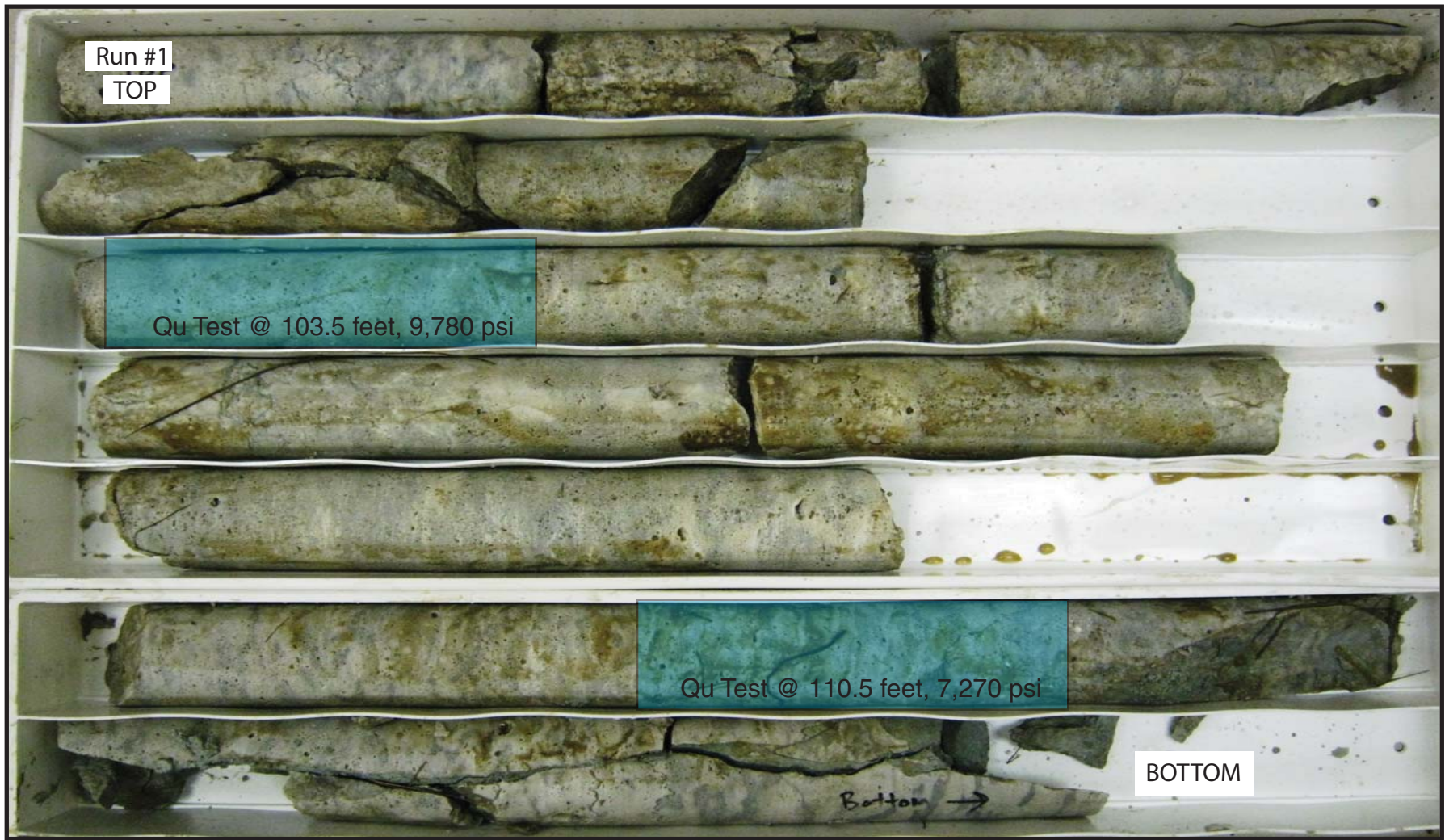

Boring 1705-B-06A
 Run #1: 102' to 112'
 RECOVERY = 100%
 RQD = 62%
 Qu = 9,780 psi @ 103.5 feet
 Qu = 7,270 psi @ 110.5 feet

BEROCK CORE: CIRCLE INTERCHANGE RECONSTRUCTION EB I-290 BRIDGE TO NB I-90/94, EN RAMP BRIDGE, SN 016-1712		
SCALE : GRAPHIC	APPENDIX C-3	DRAWN BY: M. de los Reyes CHECKED BY: C. Marin
		1145 N. Main Street Lombard, IL 60148 www.wangeng.com
FOR AECOM		1100-04-01



BORING LOG 1712-B-01

wangeng@wangeng.com
 1145 N Main Street
 Lombard, IL 60148
 Telephone: 630 953-9928
 Fax: 630 953-9938

WEI Job No.: 1100-04-01

Client **AECOM**
 Project **Circle Interchange Reconstruction**
 Location **Section 17, T39N, R14E of 3rd PM**

Datum: NAVD 88
 Elevation: 577.47 ft
 North: 1897623.12 ft
 East: 1171520.05 ft
 Station: 3644+00.68
 Offset: 14.2717 LT

Profile	Elevation (ft)	SOIL AND ROCK DESCRIPTION	Depth (ft)	Sample Type recovery	Sample No.	SPT Values (blw/6 in)	Qu (tsf)	Moisture Content (%)	Profile	Elevation (ft)	SOIL AND ROCK DESCRIPTION	Depth (ft)	Sample Type recovery	Sample No.	SPT Values (blw/6 in)	Qu (tsf)	Moisture Content (%)
	577.32	32-inch thick ASPHALT --PAVEMENT--															
	576.5	10-inch thick CONCRETE --PAVEMENT--															
	576.0	CRUSHED STONE --BASE COURSE--			1	7 6 6	4.26 B	12						9	1 2 2	< 0.25 P	25
	574.5	Hard, black SILTY CLAY --FILL--															
		Very soft to medium stiff, CLAY to SILTY CLAY, trace gravel			2	4 3 3	0.66 B	16						10	1 2 3	0.25 B	25
			5														
					3	1 2 3	0.49 B	16						11	1 2 3	0.33 B	16
					4	1 2 3	0.33 B	20						12	2 2 3	0.33 B	26
			10														
					5	1 1 2	0.16 B	25									
					6	1 2 2	0.25 B	26		543.5	Loose, gray SILT			13	3 5 4	NP	23
			15														
					7	1 1 2	0.16 B	25		540.7	Very stiff to hard, gray SILTY CLAY, trace gravel						
					8	1 2 1	0.25 B	26						14	4 6 10	2.62 B	21
			20														

WANGENGINC 11000401.GPJ WANGENG.GDT 1/9/14

GENERAL NOTES

WATER LEVEL DATA

Begin Drilling **10-27-2013** Complete Drilling **10-28-2013**
 Drilling Contractor **GSG** Drill Rig **D-50 TMR**
 Driller **J&J** Logger **C. Davis** Checked by **DRAFT**
 Drilling Method **3.25" HSA, boring backfilled upon completion**

While Drilling ∇ **57.00 ft**
 At Completion of Drilling ∇ **MUD (3')**
 Time After Drilling **24 hours**
 Depth to Water ∇ **45.00 ft**

The stratification lines represent the approximate boundary between soil types; the actual transition may be gradual.



BORING LOG 1712-B-01

wangeng@wangeng.com
 1145 N Main Street
 Lombard, IL 60148
 Telephone: 630 953-9928
 Fax: 630 953-9938

WEI Job No.: 1100-04-01

Client: **AECOM**
 Project: **Circle Interchange Reconstruction**
 Location: **Section 17, T39N, R14E of 3rd PM**

Datum: NAVD 88
 Elevation: 577.47 ft
 North: 1897623.12 ft
 East: 1171520.05 ft
 Station: 3644+00.68
 Offset: 14.2717 LT

Profile	Elevation (ft)	SOIL AND ROCK DESCRIPTION	Depth (ft)	Sample Type recovery	Sample No.	SPT Values (blw/6 in)	Qu (tsf)	Moisture Content (%)	Profile	Elevation (ft)	SOIL AND ROCK DESCRIPTION	Depth (ft)	Sample Type recovery	Sample No.	SPT Values (blw/6 in)	Qu (tsf)	Moisture Content (%)
	515.7									515.7	Hard, gray SILTY CLAY LOAM, trace gravel						
			45	X	15	4 7 10	4.35 B	13				65	X	19	16 26 46	10.25 B	13
										510.7	Very dense, gray SILTY LOAM, little gravel						
			50	X	16	4 8 12	4.02 B	20				70	X	20	34 50 50/4	NP	11
	525.7	Soft, gray CLAY with SILT lamination --Wet--									--HARD DRILLING-- --Possible Cobbles--						
			55	X	17	3 3 4	0.49 B	26			--HARD DRILLING-- --Possible Cobbles--	75	X	21	30 32 33	NP	12
	520.5	Loose, gray, coarse SAND, some gravel --Saturated--									--HARD DRILLING-- --Possible Cobbles--						
			60	X	18	7 3 3	NP	16				80	X	22	50/1		14

GENERAL NOTES

Begin Drilling **10-27-2013** Complete Drilling **10-28-2013**
 Drilling Contractor **GSG** Drill Rig **D-50 TMR**
 Driller **J&J** Logger **C. Davis** Checked by **DRAFT**
 Drilling Method **3.25" HSA, boring backfilled upon completion**

WATER LEVEL DATA

While Drilling ∇ **57.00 ft**
 At Completion of Drilling ∇ **MUD (3')**
 Time After Drilling **24 hours**
 Depth to Water ∇ **45.00 ft**

The stratification lines represent the approximate boundary between soil types; the actual transition may be gradual.

WANGENGINC 11000401.GPJ WANGENG.GDT 1/9/14



wangeng@wangeng.com
 1145 N Main Street
 Lombard, IL 60148
 Telephone: 630 953-9928
 Fax: 630 953-9938

BORING LOG 1712-B-01

WEI Job No.: 1100-04-01

Client **AECOM**
 Project **Circle Interchange Reconstruction**
 Location **Section 17, T39N, R14E of 3rd PM**

Datum: NAVD 88
 Elevation: 577.47 ft
 North: 1897623.12 ft
 East: 1171520.05 ft
 Station: 3644+00.68
 Offset: 14.2717 LT

Profile	Elevation (ft)	SOIL AND ROCK DESCRIPTION	Depth (ft)	Sample Type recovery	Sample No.	SPT Values (blw/6 in)	Qu (tsf)	Moisture Content (%)	Profile	Elevation (ft)	SOIL AND ROCK DESCRIPTION	Depth (ft)	Sample Type recovery	Sample No.	SPT Values (blw/6 in)	Qu (tsf)	Moisture Content (%)
		--ROLLER BIT REFUSAL--	85		23	50/2		11									
	492.0	--WEATHERED BEDROCK--															
	490.5	Strong, light gray, good rock mass quality, bedded, fresh DOLOSTONE, 2- to 18-inch beds, 2- to 18-inch spaced joints, horizontal and vertical joints with less than 0.2-inch infilling, hard joint wall, with stylolitic surfaces, and moderately vuggy porosity, <1.5 inch vugs.	90														
		--Run 1 - RECOVERY=100%-- --RQD=88%--			1												
			95														
	480.5	Boring terminated at 97.00 ft															
			100														

GENERAL NOTES

WATER LEVEL DATA

Begin Drilling **10-27-2013** Complete Drilling **10-28-2013**
 Drilling Contractor **GSG** Drill Rig **D-50 TMR**
 Driller **J&J** Logger **C. Davis** Checked by **DRAFT**
 Drilling Method **3.25" HSA, boring backfilled upon completion**

While Drilling ▽ **57.00 ft**
 At Completion of Drilling ▼ **MUD (3')**
 Time After Drilling **24 hours**
 Depth to Water ▼ **45.00 ft**

The stratification lines represent the approximate boundary between soil types; the actual transition may be gradual.



Boring 1712-B-01:
 Run 1#1: 87' to 97'
 RECOVERY = 100%
 RQD = 88%

BEROCK CORE: CIRCLE INTERCHANGE RECONSTRUCTION EB I-290 BRIDGE TO NB I-90/94, EN RAMP BRIDGE, SN 016-1712		
SCALE : GRAPHIC	APPENDIX C-1	DRAWN BY: A. Tomaras CHECKED BY:
		1145 N. Main Street Lombard, IL 60148 www.wangeng.com
		FOR AECOM



BORING LOG 1712-B-02

wangeng@wangeng.com
 1145 N Main Street
 Lombard, IL 60148
 Telephone: 630 953-9928
 Fax: 630 953-9938

WEI Job No.: 1100-04-01

Client **AECOM**
 Project **Circle Interchange Reconstruction**
 Location **Section 17, T39N, R14E of 3rd PM**

Datum: NAVD 88
 Elevation: 578.30 ft
 North: 1897649.82 ft
 East: 1171680.84 ft
 Station: 3645+38.58
 Offset: 8.9694 LT

Profile	Elevation (ft)	SOIL AND ROCK DESCRIPTION	Depth (ft)	Sample Type recovery	Sample No.	SPT Values (blw/6 in)	Qu (tsf)	Moisture Content (%)	Profile	Elevation (ft)	SOIL AND ROCK DESCRIPTION	Depth (ft)	Sample Type recovery	Sample No.	SPT Values (blw/6 in)	Qu (tsf)	Moisture Content (%)
		13.5-inch thick CONCRETE --PAVEMENT--															
	577.2																
	576.8	4-inch thick ASPHALT --PAVEMENT--															
		Medium dense, brown SANDY GRAVEL --BASE COURSE--			1	12 11 4	NP	9						9	0 0 0	0.16 B	22
	574.8				2	1 2 2	0.25 B	29						10	0 0 1	0.16 B	27
			5		3	0 0 0	0.16 B	21						11	0 0 2	0.33 B	23
					4	0 1 3	0.33 B	17						12	1 2 2	0.25 B	26
					5	1 1 2	0.57 B	22									
					6	0 0 1	0.16 B	25						13	1 2 1	0.41 B	28
			15		7	0 0 1	0.08 B	26		541.6	Very stiff, gray SILTY CLAY, trace gravel						
					8	0 0 0	0.16 B	26		538.8	Gray SANDY LOAM			14	5 13 18	2.62 B	16
			20														

GENERAL NOTES

Begin Drilling **10-15-2013** Complete Drilling **10-16-2013**
 Drilling Contractor **Wang Testing Services** Drill Rig **D-50 TMR**
 Driller **R&R** Logger **D. Kolpacki** Checked by **DRAFT**
 Drilling Method **2.25" SSA to 10', mud rotary thereafter, boring**
backfilled upon completion

WATER LEVEL DATA

While Drilling ∇ **57.00 ft**
 At Completion of Drilling ∇ **82.00 ft**
 Time After Drilling **NA**
 Depth to Water ∇ **NA**

The stratification lines represent the approximate boundary between soil types; the actual transition may be gradual.

WANGENGINC 11000401.GPJ WANGENG.GDT 1/9/14



BORING LOG 1712-B-02

wangeng@wangeng.com
 1145 N Main Street
 Lombard, IL 60148
 Telephone: 630 953-9928
 Fax: 630 953-9938

WEI Job No.: 1100-04-01

Client **AECOM**
 Project **Circle Interchange Reconstruction**
 Location **Section 17, T39N, R14E of 3rd PM**

Datum: NAVD 88
 Elevation: 578.30 ft
 North: 1897649.82 ft
 East: 1171680.84 ft
 Station: 3645+38.58
 Offset: 8.9694 LT

Profile	Elevation (ft)	SOIL AND ROCK DESCRIPTION	Depth (ft)	Sample Type recovery	Sample No.	SPT Values (blw/6 in)	Qu (tsf)	Moisture Content (%)	Profile	Elevation (ft)	SOIL AND ROCK DESCRIPTION	Depth (ft)	Sample Type recovery	Sample No.	SPT Values (blw/6 in)	Qu (tsf)	Moisture Content (%)
	536.6	--Moist--								536.6							
		Hard, gray SILTY LOAM to SILTY CLAY LOAM, trace gravel			15	9 22 26	6.23 B	15			Gray, coarse SAND, some gravel			19	20 20 18	NP	12
		--L _L (%)=27, P _L (%)=16-- --%Gravel=8.1-- --%Sand=26.9-- --%Silt=51.7-- --%Clay=13.3-- --A-6(5)--	45							513.8	Very dense, gray SILTY LOAM, trace gravel	65					
					16	12 17 23	4.50 P	15			--L _L (%)=19, P _L (%)=14-- --%Gravel=7.4-- --%Sand=21.3-- --%Silt=59.7-- --%Clay=11.7-- --A-4(1)--	70		20	32 50/5	NP	11
	526.6	Very stiff, gray CLAY			17	4 7 9	2.62 B	25						21	24 44 50/3	9.59 S	12
		--L _L (%)=36, P _L (%)=19-- --%Gravel=0.1-- --%Sand=2.0-- --%Silt=49.4-- --%Clay=48.5-- --A-6(17)--	55														
	521.6	Medium dense, gray SANDY LOAM, trace gravel			18	4 6 9	NP	20						22	50/3	NP	16
		--Saturated--															
			60														

GENERAL NOTES

WATER LEVEL DATA

Begin Drilling **10-15-2013** Complete Drilling **10-16-2013**
 Drilling Contractor **Wang Testing Services** Drill Rig **D-50 TMR**
 Driller **R&R** Logger **D. Kolpacki** Checked by **DRAFT**
 Drilling Method **2.25" SSA to 10', mud rotary thereafter, boring**
backfilled upon completion

While Drilling **57.00 ft**
 At Completion of Drilling **82.00 ft**
 Time After Drilling **NA**
 Depth to Water **NA**

The stratification lines represent the approximate boundary between soil types; the actual transition may be gradual.

WANGENGINC-11000401.GPJ WANGENG.GDT 1/9/14



BORING LOG 1712-B-02

wangeng@wangeng.com
 1145 N Main Street
 Lombard, IL 60148
 Telephone: 630 953-9928
 Fax: 630 953-9938

WEI Job No.: 1100-04-01

Client **AECOM**
 Project **Circle Interchange Reconstruction**
 Location **Section 17, T39N, R14E of 3rd PM**

Datum: NAVD 88
 Elevation: 578.30 ft
 North: 1897649.82 ft
 East: 1171680.84 ft
 Station: 3645+38.58
 Offset: 8.9694 LT

Profile	Elevation (ft)	SOIL AND ROCK DESCRIPTION	Depth (ft)	Sample Type recovery	Sample No.	SPT Values (blw/6 in)	Qu (tsf)	Moisture Content (%)	Profile	Elevation (ft)	SOIL AND ROCK DESCRIPTION	Depth (ft)	Sample Type recovery	Sample No.	SPT Values (blw/6 in)	Qu (tsf)	Moisture Content (%)
	496.6	Very dense, gray SILT --Saturated--								477.3	Boring terminated at 101.00 ft						
		--%Gravel=0.0-- --%Sand=1.7-- --%Silt=91.5-- --%Clay=6.8-- --A-4(0)--	85		23	20 34 50	NP	19				105					
			90		24	30 50/5	NP	16				110					
	487.3	Strong, light gray, fair rock mass quality, thin bedded, fresh DOLOSTONE, 2- to 44-inch beds, 2- to 44-inch spaced joints, horizontal and vertical joints with less than 0.2-inch infilling, hard joint wall, with stylolitic surfaces, and moderately vuggy porosity, <0.5 inch vugs. --Run 1 - RECOVERY=100%-- --RQD=71%--	95									115					
			100		1							120					

GENERAL NOTES

Begin Drilling **10-15-2013** Complete Drilling **10-16-2013**
 Drilling Contractor **Wang Testing Services** Drill Rig **D-50 TMR**
 Driller **R&R** Logger **D. Kolpacki** Checked by **DRAFT**
 Drilling Method **2.25" SSA to 10', mud rotary thereafter, boring backfilled upon completion**

WATER LEVEL DATA

While Drilling ∇ **57.00 ft**
 At Completion of Drilling ∇ **82.00 ft**
 Time After Drilling **NA**
 Depth to Water ∇ **NA**

The stratification lines represent the approximate boundary between soil types; the actual transition may be gradual.

WANGENGINC 11000401.GPJ WANGENG.GDT 1/9/14

Run #1

TOP



BOTTOM

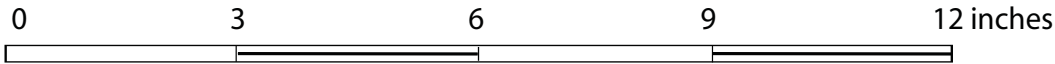

Boring 1712-B-02
 Run #1: 91' to 101'
 RECOVERY = 100%
 RQD = 77%

BEROCK CORE: CIRCLE INTERCHANGE RECONSTRUCTION
 EB I-290 BRIDGE TO NB I-90/94, EN RAMP BRIDGE, SN 016-1712

SCALE : GRAPHIC

APPENDIX C-2

DRAWN BY: M. de los Reyes
CHECKED BY: M. Snider



1145 N. Main Street
 Lombard, IL 60148
 www.wangeng.com

FOR AECOM

1100-04-01



wangeng@wangeng.com
 1145 N Main Street
 Lombard, IL 60148
 Telephone: 630 953-9928
 Fax: 630 953-9938

BORING LOG 18-RWB-01

WEI Job No.: 1100-04-01

Client **AECOM**
 Project **Circle Interchange Reconstruction**
 Location **Section 17, T39N, R14E of 3rd PM**

Datum: NAVD 88
 Elevation: 585.35 ft
 North: 1897627.64 ft
 East: 1171433.33 ft
 Station: 5240+15.29
 Offset: 14.5957 RT

Profile	Elevation (ft)	SOIL AND ROCK DESCRIPTION	Depth (ft)	Sample Type recovery	Sample No.	SPT Values (blw/6 in)	Qu (tsf)	Moisture Content (%)	Profile	Elevation (ft)	SOIL AND ROCK DESCRIPTION	Depth (ft)	Sample Type recovery	Sample No.	SPT Values (blw/6 in)	Qu (tsf)	Moisture Content (%)
	585.04	1/2-inch thick, black SILTY LOAM --TOPSOIL-- Very stiff to hard, brown and gray SILTY CLAY LOAM, trace gravel --FILL--			1	13 11 12	4.50 P	17						9	1 2 3	0.41 B	24
			5		2	6 6 8	3.44 B	17				25		10	1 2 2	0.33 B	26
	579.8	Very soft to medium stiff, gray CLAY to SILTY CLAY, trace gravel			3	2 2 3	0.41 B	20						11	1 1 2	0.25 B	27
			10		4	2 2 3	0.49 B	20				30		12	1 1 2	0.16 B	25
					5	0 1 2	0.25 B	25									
			15		6	2 3 4	0.66 B	21				35		13	2 2 4	0.66 B	24
					7	2 3 4	0.57 B	22									
			20		8	1 3 3	0.49 B	25				40		14	2 3 4	0.49 B	26

GENERAL NOTES

Begin Drilling **10-16-2013** Complete Drilling **10-17-2013**
 Drilling Contractor **Wang Testing Services** Drill Rig **D-25 ATV**
 Driller **P&N** Logger **F.Bozga** Checked by **DRAFT**
 Drilling Method **2.25" HSA to 10', mud rotary thereafter, boring**
backfilled upon completion

WATER LEVEL DATA

While Drilling ∇ **52.00 ft**
 At Completion of Drilling ∇ **MUD (3')**
 Time After Drilling **NA**
 Depth to Water ∇ **NA**

The stratification lines represent the approximate boundary between soil types; the actual transition may be gradual.

WANGENGINC 11000401.GPJ WANGENG.GDT 1/9/14



BORING LOG 19-RWB-01

wangeng@wangeng.com
 1145 N Main Street
 Lombard, IL 60148
 Telephone: 630 953-9928
 Fax: 630 953-9938

WEI Job No.: 1100-04-01

Client **AECOM**
 Project **Circle Interchange Reconstruction**
 Location **Section 17, T39N, R14E of 3rd PM**

Datum: NAVD 88
 Elevation: 588.28 ft
 North: 1897670.99 ft
 East: 1171413.08 ft
 Station: 5136+72.06
 Offset: 86.2604 RT

Profile	Elevation (ft)	SOIL AND ROCK DESCRIPTION	Depth (ft)	Sample Type recovery	Sample No.	SPT Values (blw/6 in)	Qu (tsf)	Moisture Content (%)	Profile	Elevation (ft)	SOIL AND ROCK DESCRIPTION	Depth (ft)	Sample Type recovery	Sample No.	SPT Values (blw/6 in)	Qu (tsf)	Moisture Content (%)
	588.04	inch thick, dark brown SILTY LOAM --TOPSOIL-- Dense, dark brown SILTY LOAM, trace gravel --FILL--			1	6 23 22	NP										
	585.3	Stiff, brown and gray SILTY CLAY LOAM, trace gravel	5		2	3 6 7	1.97 B	17				25		10	1 1 2	0.16 B	27
					3	3 3 4	1.15 B	21						11	1 1 2	0.25 B	27
	580.3	Very soft to medium stiff, gray CLAY to SILTY CLAY, trace gravel	10		4	1 2 3	0.33 B	24				30		12	1 1 2	0.33 B	27
					5	1 1 1	0.08 B	25									
					6	1 1 2	0.25 B	29				35		13	0 2 2	0.25 B	27
					7	1 4 10	NA										
					8	4 3 4	0.49 B	17				40		14	2 2 3	0.66 B	26

GENERAL NOTES

WATER LEVEL DATA

Begin Drilling **10-14-2013** Complete Drilling **10-16-2013**
 Drilling Contractor **Wang Testing Services** Drill Rig **D-25 ATV**
 Driller **P&N** Logger **F.Bozga** Checked by **DRAFT**
 Drilling Method **2.25" HSA to 10', mud rotary thereafter, boring**
backfilled upon completion

While Drilling **67.00 ft**
 At Completion of Drilling **MUD (6')**
 Time After Drilling **48 hours**
 Depth to Water **15.00 ft**

The stratification lines represent the approximate boundary between soil types; the actual transition may be gradual.

WANGENGINC 11000401.GPJ WANGENG.GDT 1/9/14



wangeng@wangeng.com
 1145 N Main Street
 Lombard, IL 60148
 Telephone: 630 953-9928
 Fax: 630 953-9938

BORING LOG 19-RWB-01

WEI Job No.: 1100-04-01

Client **AECOM**
 Project **Circle Interchange Reconstruction**
 Location **Section 17, T39N, R14E of 3rd PM**

Datum: NAVD 88
 Elevation: 588.28 ft
 North: 1897670.99 ft
 East: 1171413.08 ft
 Station: 5136+72.06
 Offset: 86.2604 RT

Profile	Elevation (ft)	SOIL AND ROCK DESCRIPTION	Depth (ft)	Sample Type recovery	Sample No.	SPT Values (blw/6 in)	Qu (tsf)	Moisture Content (%)	Profile	Elevation (ft)	SOIL AND ROCK DESCRIPTION	Depth (ft)	Sample Type recovery	Sample No.	SPT Values (blw/6 in)	Qu (tsf)	Moisture Content (%)
	541.5	Stiff to hard, gray SILTY CLAY to SILTY CLAY LOAM, trace gravel	45	X	15	2 2 5	0.41 B	21		521.5	Dense, gray, medium SAND --Saturated--	65	X	19	5 6 7	2.13 B	30
			50	X	16	3 5 8	1.48 B	23				70	X	20	11 13 17	NP	19
			55	X	17	6 11 19	4.84 B	14		515.3	Hard, gray SILTY CLAY LOAM, trace gravel	75	X	21	17 32 50/4	7.71 B	15
			60	X	18	14 23 31	5.41 B	18		511.5	Very dense, gray SILTY LOAM, trace gravel	80	X	22	37 50/5	NP	10

GENERAL NOTES

Begin Drilling **10-14-2013** Complete Drilling **10-16-2013**
 Drilling Contractor **Wang Testing Services** Drill Rig **D-25 ATV**
 Driller **P&N** Logger **F.Bozga** Checked by **DRAFT**
 Drilling Method **2.25" HSA to 10', mud rotary thereafter, boring**
 **backfilled upon completion**

WATER LEVEL DATA

While Drilling ▽ **67.00 ft**
 At Completion of Drilling ▼ **MUD (6')**
 Time After Drilling **48 hours**
 Depth to Water ▼ **15.00 ft**

The stratification lines represent the approximate boundary between soil types; the actual transition may be gradual.

WANGENGINC 11000401.GPJ WANGENG.GDT 1/9/14



wangeng@wangeng.com
 1145 N Main Street
 Lombard, IL 60148
 Telephone: 630 953-9928
 Fax: 630 953-9938

BORING LOG 19-RWB-01

WEI Job No.: 1100-04-01

Client **AECOM**
 Project **Circle Interchange Reconstruction**
 Location **Section 17, T39N, R14E of 3rd PM**

Datum: NAVD 88
 Elevation: 588.28 ft
 North: 1897670.99 ft
 East: 1171413.08 ft
 Station: 5136+72.06
 Offset: 86.2604 RT

Profile	Elevation (ft)	SOIL AND ROCK DESCRIPTION	Depth (ft)	Sample Type recovery	Sample No.	SPT Values (blw/6 in)	Qu (tsf)	Moisture Content (%)	Profile	Elevation (ft)	SOIL AND ROCK DESCRIPTION	Depth (ft)	Sample Type recovery	Sample No.	SPT Values (blw/6 in)	Qu (tsf)	Moisture Content (%)
		--HARD DRILLING-- --Possible Cobbles--															
	501.5	Very dense, gray SILT	85		23	29 34 40	NP	11									
			90		24	15 50/5	NP	18									
	494.4	2-inch thick, DOLOSTONE fragments			25	50/4	NP	17									
	493.3	--HARD DRILLING-- --WEATHERED BEDROCK-- Boring terminated at 95.00 ft	95														
			100														

GENERAL NOTES

WATER LEVEL DATA

Begin Drilling **10-14-2013** Complete Drilling **10-16-2013**
 Drilling Contractor **Wang Testing Services** Drill Rig **D-25 ATV**
 Driller **P&N** Logger **F.Bozga** Checked by **DRAFT**
 Drilling Method **2.25" HSA to 10', mud rotary thereafter, boring**
 **backfilled upon completion**

While Drilling ▽ **67.00 ft**
 At Completion of Drilling ▼ **MUD (6')**
 Time After Drilling **48 hours**
 Depth to Water ▼ **15.00 ft**

The stratification lines represent the approximate boundary between soil types; the actual transition may be gradual.



wangeng@wangeng.com
 1145 N Main Street
 Lombard, IL 60148
 Telephone: 630 953-9928
 Fax: 630 953-9938

BORING LOG 20-RWB-01

WEI Job No.: 1100-04-01

Client: **AECOM**
 Project: **Circle Interchange Reconstruction**
 Location: **Section 17, T39N, R14E of 3rd PM**

Datum: NAVD 88
 Elevation: 577.12 ft
 North: 1897711.41 ft
 East: 1171734.33 ft
 Station: 7308+20.74
 Offset: 20.9635 RT

Profile	Elevation (ft)	SOIL AND ROCK DESCRIPTION	Depth (ft)	Sample Type recovery	Sample No.	SPT Values (blw/6 in)	Qu (tsf)	Moisture Content (%)	Profile	Elevation (ft)	SOIL AND ROCK DESCRIPTION	Depth (ft)	Sample Type recovery	Sample No.	SPT Values (blw/6 in)	Qu (tsf)	Moisture Content (%)
		13.5-inch thick CONCRETE --PAVEMENT--															
	576.0	4.5-inch thick ASPHALT --PAVEMENT--															
	575.8																
		Dense, white CRUSHED STONE --BASE COURSE--			1	26 30 11	NP							9	0 1 1	0.16 B	25
	574.1	Very soft to medium stiff, gray CLAY to SILTY CLAY, trace gravel			2	2 1 1	0.25 B	27				25		10	0 1 2	0.16 B	26
						3	2 2 1	0.16 B	28					11	1 2 2	0.16 B	26
						4	1 1 2	0.41 B	24					12	2 2 1	0.57 B	27
						5	1 2 1	0.33 B	24								
						6	1 1 2	0.41 B	24					13	1 2 2	0.08 B	26
						7	2 1 2	0.16 B	18		540.4	Stiff to hard, gray SILTY CLAY to SILTY CLAY LOAM, trace gravel					
						8	0 1 1	0.16 B	26						14	3 6 10	1.72 B

GENERAL NOTES

Begin Drilling **10-28-2013** Complete Drilling **11-03-2013**
 Drilling Contractor **Wang Testing Services** Drill Rig **CME-55 TMR**
 Driller **R&J** Logger **A. Tomaras** Checked by **DRAFT**
 Drilling Method **2.25" SSA to 10', mud rotary thereafter, boring**
backfilled upon completion

WATER LEVEL DATA

While Drilling ∇ **NA**
 At Completion of Drilling ∇ **NA**
 Time After Drilling **NA**
 Depth to Water ∇ **NA**

The stratification lines represent the approximate boundary between soil types; the actual transition may be gradual.

WANGENGINC 11000401.GPJ WANGENG.GDT 1/9/14



wangeng@wangeng.com
 1145 N Main Street
 Lombard, IL 60148
 Telephone: 630 953-9928
 Fax: 630 953-9938

BORING LOG 20-RWB-01

WEI Job No.: 1100-04-01

Client: **AECOM**
 Project: **Circle Interchange Reconstruction**
 Location: **Section 17, T39N, R14E of 3rd PM**

Datum: NAVD 88
 Elevation: 577.12 ft
 North: 1897711.41 ft
 East: 1171734.33 ft
 Station: 7308+20.74
 Offset: 20.9635 RT

Profile	Elevation (ft)	SOIL AND ROCK DESCRIPTION	Depth (ft)	Sample Type recovery	Sample No.	SPT Values (blw/6 in)	Qu (tsf)	Moisture Content (%)	Profile	Elevation (ft)	SOIL AND ROCK DESCRIPTION	Depth (ft)	Sample Type recovery	Sample No.	SPT Values (blw/6 in)	Qu (tsf)	Moisture Content (%)
	520.4	Loose, gray SILT --Saturated--								500.4	Very dense, gray SILTY LOAM, trace gravel						
			45	X	15	7 8 15	5.74 B	13		514.1	Very dense, gray, coarse SAND	65	X	19	48 50/5	NP	11
											--HARD DRILLING-- --Possible Cobbles--						
			50	X	16	6 9 12	3.94 B	20		510.1	Hard, gray SILTY CLAY LOAM to SILTY LOAM, trace gravel	70	X	20	32 45 45	5.41 S	10
											--HARD DRILLING-- --Possible Cobbles--						
			55	X	17	6 8 9	1.56 B	21				75	X	21	20 18 35	7.30 S	17
			60	X	18	3 3 6	1.31 S	29				80	X	22	39 47 48	NP	15

GENERAL NOTES

Begin Drilling **10-28-2013** Complete Drilling **11-03-2013**
 Drilling Contractor **Wang Testing Services** Drill Rig **CME-55 TMR**
 Driller **R&J** Logger **A. Tomaras** Checked by **DRAFT**
 Drilling Method **2.25" SSA to 10', mud rotary thereafter, boring**
backfilled upon completion

WATER LEVEL DATA

While Drilling **NA**
 At Completion of Drilling **NA**
 Time After Drilling **NA**
 Depth to Water **NA**

The stratification lines represent the approximate boundary between soil types; the actual transition may be gradual.

WANGENGINC 11000401.GPJ WANGENG.GDT 1/9/14



wangeng@wangeng.com
 1145 N Main Street
 Lombard, IL 60148
 Telephone: 630 953-9928
 Fax: 630 953-9938

BORING LOG 20-RWB-01

WEI Job No.: 1100-04-01

Client **AECOM**
 Project **Circle Interchange Reconstruction**
 Location **Section 17, T39N, R14E of 3rd PM**

Datum: NAVD 88
 Elevation: 577.12 ft
 North: 1897711.41 ft
 East: 1171734.33 ft
 Station: 7308+20.74
 Offset: 20.9635 RT

Profile	Elevation (ft)	SOIL AND ROCK DESCRIPTION	Depth (ft)	Sample Type recovery	Sample No.	SPT Values (blw/6 in)	Qu (tsf)	Moisture Content (%)	Profile	Elevation (ft)	SOIL AND ROCK DESCRIPTION	Depth (ft)	Sample Type recovery	Sample No.	SPT Values (blw/6 in)	Qu (tsf)	Moisture Content (%)
		--HARD DRILLING-- --Possible Cobbles--															
	495.4	Very dense, gray GRAVELLY SAND, some cobbles															
			85		23	50/1	NA										
	487.6	--BEDROCK--	90		24	39 50/5	NP	11									
	486.1	Boring terminated at 91.00 ft															
			95														
			100														

GENERAL NOTES

WATER LEVEL DATA

Begin Drilling **10-28-2013** Complete Drilling **11-03-2013**
 Drilling Contractor **Wang Testing Services** Drill Rig **CME-55 TMR**
 Driller **R&J** Logger **A. Tomaras** Checked by **DRAFT**
 Drilling Method **2.25" SSA to 10', mud rotary thereafter, boring**
 **backfilled upon completion**

While Drilling ▽ **NA**
 At Completion of Drilling ▼ **NA**
 Time After Drilling **NA**
 Depth to Water ▼ **NA**

The stratification lines represent the approximate boundary between soil types; the actual transition may be gradual.



wangeng@wangeng.com
 1145 N Main Street
 Lombard, IL 60148
 Telephone: 630 953-9928
 Fax: 630 953-9938

BORING LOG 21-RWB-03

WEI Job No.: 1100-04-01

Client: **AECOM**
 Project: **Circle Interchange Reconstruction**
 Location: **Section 17, T39N, R14E of 3rd PM**

Datum: NAVD 88
 Elevation: 591.97 ft
 North: 1897787.89 ft
 East: 1171858.64 ft
 Station: 1610+92.09
 Offset: 7.9354 RT

Profile	Elevation (ft)	SOIL AND ROCK DESCRIPTION	Depth (ft)	Sample Type recovery	Sample No.	SPT Values (blw/6 in)	Qu (tsf)	Moisture Content (%)	Profile	Elevation (ft)	SOIL AND ROCK DESCRIPTION	Depth (ft)	Sample Type recovery	Sample No.	SPT Values (blw/6 in)	Qu (tsf)	Moisture Content (%)
	581.5	Very stiff to hard, brown CLAY LOAM, trace brick fragments --FILL-- --3-inch thick, red, crushed Brick--	0	1	1	3 4 8	3.50 P	11		581.5		0	9	9	0 0 0	0.33 B	23
			5	2	2	5 5 7	3.12 B	14				25	10	10	0 0 2	0.25 B	26
			10	3	3	13 8 6	NP	19					11	11	0 1 2	0.45 B	26
			15	4	4	5 5 7	6.56 B	15				30	12	12	2 2 2	< 0.25 P	25
			20	5	5	2 3 4	1.97 B	23									
			25	6	6	2 1 3	0.57 B	25				35	13	13	1 2 2	0.57 B	24
			30	7	7	2 1 2	0.49 B	25									
			40	8	8	2 2 2	< 0.25 P	28				40	14	14	2 3 3	0.49 B	25
	579.0	Stiff, gray SILTY CLAY, trace gravel Very soft to medium stiff, gray CLAY, trace gravel	45	5	5	2 3 4	1.97 B	23		579.0		45	13	13	1 2 2	0.57 B	24
			50	6	6	2 1 3	0.57 B	25				35	13	13	1 2 2	0.57 B	24
			55	7	7	2 1 2	0.49 B	25				40	14	14	2 3 3	0.49 B	25

GENERAL NOTES

Begin Drilling **09-23-2013** Complete Drilling **09-23-2013**
 Drilling Contractor **Wang Testing Services** Drill Rig **CME-55 TMR**
 Driller **R&J** Logger **A. Tomaras** Checked by **L. lordache**
 Drilling Method **3.25" HSA, boring backfilled upon completion**

WATER LEVEL DATA

While Drilling **MUD**
 At Completion of Drilling **MUD**
 Time After Drilling **NA**
 Depth to Water **NA**

The stratification lines represent the approximate boundary between soil types; the actual transition may be gradual.



wangeng@wangeng.com
 1145 N Main Street
 Lombard, IL 60148
 Telephone: 630 953-9928
 Fax: 630 953-9938

BORING LOG 21-RWB-03

WEI Job No.: 1100-04-01

Client **AECOM**
 Project **Circle Interchange Reconstruction**
 Location **Section 17, T39N, R14E of 3rd PM**

Datum: NAVD 88
 Elevation: 591.97 ft
 North: 1897787.89 ft
 East: 1171858.64 ft
 Station: 1610+92.09
 Offset: 7.9354 RT

Profile	Elevation (ft)	SOIL AND ROCK DESCRIPTION	Depth (ft)	Sample Type recovery	Sample No.	SPT Values (blw/6 in)	Qu (tsf)	Moisture Content (%)	Profile	Elevation (ft)	SOIL AND ROCK DESCRIPTION	Depth (ft)	Sample Type recovery	Sample No.	SPT Values (blw/6 in)	Qu (tsf)	Moisture Content (%)
			45	X	15	2 3 3	< 0.25 P	27				65	X	19	15 17 24	4.10 B	27
			50	X	16	0 2 2	0.41 B	28				70	X	20	16 17 20	8.53 B	12
	540.2	Very stiff to hard, SILTY CLAY to SILTY CLAY LOAM, trace gravel								520.2	Dense, gray SILT						
			55	X	17	4 5 8	1.48 B	22				75	X	21	20 26 23	NP	21
										515.2	Hard, gray SILTY CLAY LOAM, trace gravel						
			60	X	18	14 12 15	3.00 P	16				80	X	22	19 20 28	8.61 S	14

GENERAL NOTES

WATER LEVEL DATA

Begin Drilling **09-23-2013** Complete Drilling **09-23-2013**
 Drilling Contractor **Wang Testing Services** Drill Rig **CME-55 TMR**
 Driller **R&J** Logger **A. Tomaras** Checked by **L. lordache**
 Drilling Method **3.25" HSA, boring backfilled upon completion**

While Drilling ∇ **MUD**
 At Completion of Drilling ∇ **MUD**
 Time After Drilling **NA**
 Depth to Water ∇ **NA**

The stratification lines represent the approximate boundary between soil types; the actual transition may be gradual.

WANGENGINC 11000401.GPJ WANGENG.GDT 1/9/14



BORING LOG 21-RWB-03

wangeng@wangeng.com
 1145 N Main Street
 Lombard, IL 60148
 Telephone: 630 953-9928
 Fax: 630 953-9938

WEI Job No.: 1100-04-01

Client: **AECOM**
 Project: **Circle Interchange Reconstruction**
 Location: **Section 17, T39N, R14E of 3rd PM**

Datum: NAVD 88
 Elevation: 591.97 ft
 North: 1897787.89 ft
 East: 1171858.64 ft
 Station: 1610+92.09
 Offset: 7.9354 RT

Profile	Elevation (ft)	SOIL AND ROCK DESCRIPTION	Depth (ft)	Sample Type recovery	Sample No.	SPT Values (blw/6 in)	Qu (tsf)	Moisture Content (%)	Profile	Elevation (ft)	SOIL AND ROCK DESCRIPTION	Depth (ft)	Sample Type recovery	Sample No.	SPT Values (blw/6 in)	Qu (tsf)	Moisture Content (%)
	510.2	Very dense, gray SILT --HARD DRILLING--	85	23	23	31 32 50/5	NP	15		490.2	Very dense, weathered DOLOSTONE fragments --WEATHERED BEDROCK--	27	27	50/1	NP		
	505.2	Very dense, gray SILTY LOAM, trace gravel	90	24	23 33 29	6.81 S		21		487.5	--ROLLER BIT REFUSAL-- Boring terminated at 104.50 ft	105					
			95	25	66/6 44/3	NP		15				115					
	495.2	--HARD DRILLING-- Very dense, brown SANDY GRAVEL	100	26	30 70/6	NP		6				120					

GENERAL NOTES

WATER LEVEL DATA

Begin Drilling **09-23-2013** Complete Drilling **09-23-2013**
 Drilling Contractor **Wang Testing Services** Drill Rig **CME-55 TMR**
 Driller **R&J** Logger **A. Tomaras** Checked by **L. lordache**
 Drilling Method **3.25" HSA, boring backfilled upon completion**

While Drilling ∇ **MUD**
 At Completion of Drilling ∇ **MUD**
 Time After Drilling **NA**
 Depth to Water ∇ **NA**

The stratification lines represent the approximate boundary between soil types; the actual transition may be gradual.

WANGENGINC 11000401.GPJ WANGENG.GDT 1/9/14



BORING LOG 1705-B-06

wangeng@wangeng.com
 1145 N Main Street
 Lombard, IL 60148
 Telephone: 630 953-9928
 Fax: 630 953-9938

WEI Job No.: 1100-04-01

Client: **AECOM**
 Project: **Circle Interchange Reconstruction**
 Location: **Section 17, T39N, R14E of 3rd PM**

Datum: NAVD 88
 Elevation: 591.98 ft
 North: 1897750.88 ft
 East: 1171805.18 ft
 Station: 1816+16.38
 Offset: 1.5665 LT

Profile	Elevation (ft)	SOIL AND ROCK DESCRIPTION	Depth (ft)	Sample Type recovery	Sample No.	SPT Values (blw/6 in)	Qu (tsf)	Moisture Content (%)	Profile	Elevation (ft)	SOIL AND ROCK DESCRIPTION	Depth (ft)	Sample Type recovery	Sample No.	SPT Values (blw/6 in)	Qu (tsf)	Moisture Content (%)
		Drilled without sampling									--S _{u undis} = 569.8 psf-- --S _{u remold} = 310.8 psf-- --Sensitivity = 1.83--			2			
			5								--In-Situ Vane Shear, 25.5 feet-- --S _{u undis} = 1165.5 psf-- --S _{u remold} = 543.9 psf-- --Sensitivity = 2.14--			3			
			10								--In-Situ Vane Shear, 30.5 feet-- --S _{u undis} = 880.6 psf-- --S _{u remold} = 543.9 psf-- --Sensitivity = 1.62--			4			
		--In-Situ Vane Shear, 15.5 feet-- --S _{u undis} = 1344.0 psf-- --S _{u remold} = 775.0 psf-- --Sensitivity = 1.73--	15		1						--In-Situ Vane Shear, 35.5 feet-- --S _{u undis} = 1295.0 psf-- --S _{u remold} = 828.8 psf-- --Sensitivity = 1.56--			5			
		--In-Situ Vane Shear, 20.5 feet--	20								--In-Situ Vane Shear, 40.5 feet--	40					

GENERAL NOTES

WATER LEVEL DATA

Begin Drilling **07-26-2013** Complete Drilling **07-26-2013**
 Drilling Contractor **Wang Testing Services** Drill Rig **CME-55 TMR**
 Driller **R&J** Logger **A. Tomaras** Checked by **C. Marin**
 Drilling Method **3.25" HSA, boring backfilled upon completion**

While Drilling ∇ **NA**
 At Completion of Drilling ∇ **NA**
 Time After Drilling **NA**
 Depth to Water ∇ **NA**

The stratification lines represent the approximate boundary between soil types; the actual transition may be gradual.



wangeng@wangeng.com
 1145 N Main Street
 Lombard, IL 60148
 Telephone: 630 953-9928
 Fax: 630 953-9938

BORING LOG 1705-B-06

WEI Job No.: 1100-04-01

Client **AECOM**
 Project **Circle Interchange Reconstruction**
 Location **Section 17, T39N, R14E of 3rd PM**

Datum: NAVD 88
 Elevation: 591.98 ft
 North: 1897750.88 ft
 East: 1171805.18 ft
 Station: 1816+16.38
 Offset: 1.5665 LT

Profile	Elevation (ft)	SOIL AND ROCK DESCRIPTION	Depth (ft)	Sample Type recovery	Sample No.	SPT Values (blw/6 in)	Qu (tsf)	Moisture Content (%)	Profile	Elevation (ft)	SOIL AND ROCK DESCRIPTION	Depth (ft)	Sample Type recovery	Sample No.	SPT Values (blw/6 in)	Qu (tsf)	Moisture Content (%)
		-- $S_{u\ undis}$ = 1113.7 psf-- -- $S_{u\ remold}$ = 621.6 psf-- --Sensitivity = 1.79--			6												
		--In-Situ Vane Shear, 45.5 feet-- -- $S_{u\ undis}$ = 1191.4 psf-- -- $S_{u\ remold}$ = 621.6 psf-- --Sensitivity = 1.92--	45		7												
		Boring terminated at 50.00 ft	50														
			55														
			60														

GENERAL NOTES

Begin Drilling **07-26-2013** Complete Drilling **07-26-2013**
 Drilling Contractor **Wang Testing Services** Drill Rig **CME-55 TMR**
 Driller **R&J** Logger **A. Tomaras** Checked by **C. Marin**
 Drilling Method **3.25" HSA, boring backfilled upon completion**

WATER LEVEL DATA

While Drilling **NA**
 At Completion of Drilling **NA**
 Time After Drilling **NA**
 Depth to Water **NA**

The stratification lines represent the approximate boundary between soil types; the actual transition may be gradual.

APPENDIX B

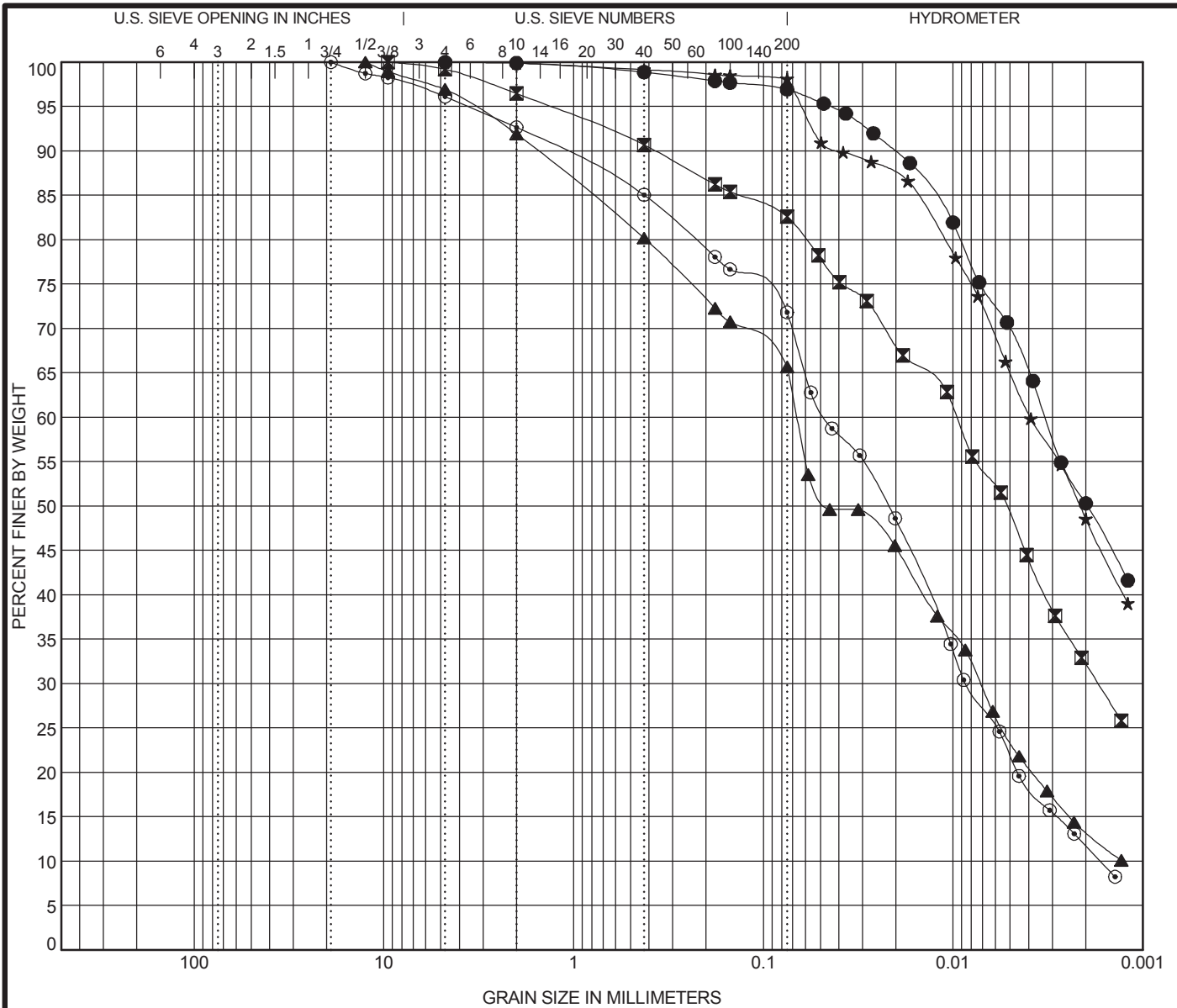

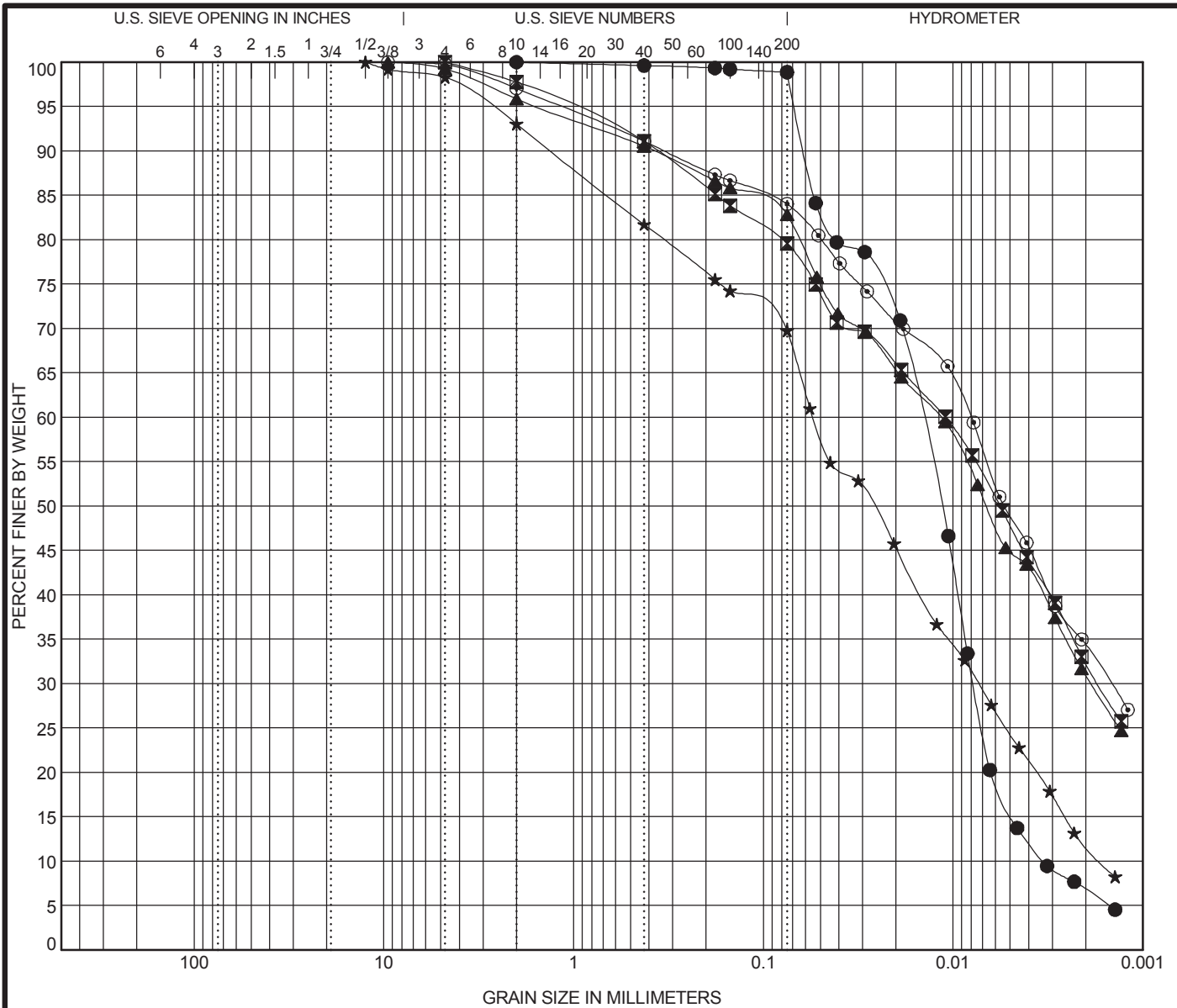

COBBLES	GRAVEL	SAND		SILT AND CLAY
		coarse	fine	

Specimen Identification	IDH Classification	LL	PL	PI	Cc	Cu
● 1712-B-02#23 83.5 ft	Silt	NP	NP	NP	1.25	4.36
☒ 19-RWB-01#3 6.0 ft	Clay	31	17	14		
▲ 19-RWB-01#6 13.5 ft	Silty Clay	31	18	13		
★ 19-RWB-01#8 18.5 ft	Silty Loam	23	16	7	0.59	32.74
⊙ 19-RWB-01#14 38.5 ft	Silty Clay	34	18	16		

Specimen Identification	D100	D60	D30	D10	%Gravel	%Sand	%Silt	%Clay
● 1712-B-02#23 83.5 ft	2	0.015	0.008	0.003	0.0	1.7	91.5	6.8
☒ 19-RWB-01#3 6.0 ft	4.75	0.011	0.002		2.2	18.3	47.1	32.3
▲ 19-RWB-01#6 13.5 ft	9.5	0.012	0.002		4.1	13.3	51.6	31.0
★ 19-RWB-01#8 18.5 ft	12.5	0.055	0.007	0.002	6.9	23.7	57.5	11.8
⊙ 19-RWB-01#14 38.5 ft	9.5	0.008	0.001		2.9	13.1	49.6	34.3



Wang Engineering, Inc.
 1145 N Main Street
 Lombard, IL 60148
 Telephone: 630 953-9928
 Fax: 630 953-9938

GRAIN SIZE DISTRIBUTION

Project: Circle Interchange Reconstruction
 Location: Section 17, T39N, R14E of 3rd PM
 Number: 1100-04-01

WEI GRAIN SIZE IDH 11000401.GPJ US_LAB.GDT 11/26/13

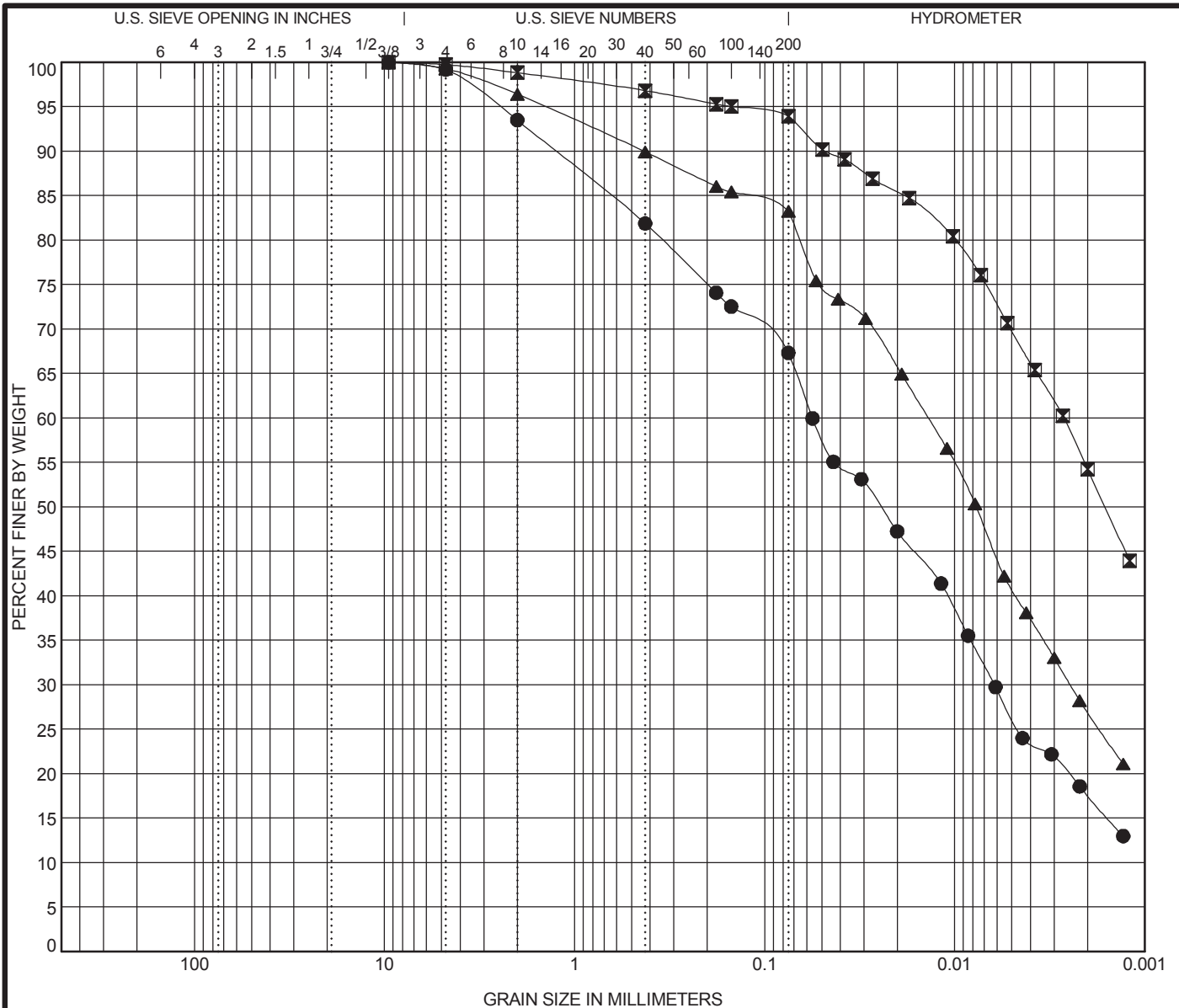

COBBLES	GRAVEL	SAND		SILT AND CLAY
		coarse	fine	

Specimen Identification	IDH Classification	LL	PL	PI	Cc	Cu
● 19-RWB-01#17 53.5 ft	Silty Loam	25	16	9		
☒ 19-RWB-01#19 63.5 ft	Clay	44	20	24		
▲ 19-RWB-01#21 73.5 ft	Silty Clay Loam	29	16	13		

Specimen Identification	D100	D60	D30	D10	%Gravel	%Sand	%Silt	%Clay
● 19-RWB-01#17 53.5 ft	9.5	0.056	0.006		6.5	26.5	49.4	17.6
☒ 19-RWB-01#19 63.5 ft	9.5	0.003			1.2	5.0	39.6	54.2
▲ 19-RWB-01#21 73.5 ft	9.5	0.014	0.002		3.6	13.5	56.0	26.9



Wang Engineering, Inc.
 1145 N Main Street
 Lombard, IL 60148
 Telephone: 630 953-9928
 Fax: 630 953-9938

GRAIN SIZE DISTRIBUTION
 Project: Circle Interchange Reconstruction
 Location: Section 17, T39N, R14E of 3rd PM
 Number: 1100-04-01

WEI GRAIN SIZE IDH 11000401.GPJ US_LAB.GDT 11/26/13



Unconfined Compressive Strength of Intact Rock Core Specimens

Project: Circle Interchange Reconstruction

Client: AECOM

WEI Job No.: 1100-04-01

Note: The specimens were sulphur capped for a more uniform break

Field Sample ID	Lab Specimen ID	Depth (feet)	Location	Length (inches)			Diameter (inches)	Total Load (lbs)	Total Pressure (psi)	Fracture Type*	Break Date	Tested By	Area (in ²)
				Total Core	Before Capping	After Capping							
1705-B-06A Run #1	122	103.5	EN Ramp Bridge SN 016-1712	N/A	4.03	4.14	2.05	32280	9780	3	8/26/2013	RG	3.30
1705-B-06A Run #1	123	110.5	EN Ramp Bridge SN 016-1712	N/A	4.07	4.18	2.05	23980	7270	3	8/26/2013	RG	3.30

*** Fracture Types:**
 Type 1 - Reasonably well-formed cones on both ends, less than 1 in. [25 mm] of cracking through caps;
 Type 2 - Well-formed cone on one end, vertical cracks running through caps, no well defined cone on other end;
 Type 3 - Columnar vertical cracking through both ends, no well-formed cones;
 Type 4 - Diagonal fracture with no cracking through ends; tap with hammer to distinguish from Type 1;
 Type 5 - Side fractures at top or bottom (occur commonly with unbonded caps);
 Type 6 - Similar to Type 5 but end of cylinder is pointed.

Prepared by: _____
 Checked by: _____

APPENDIX C

Benchmark: Cut square on center of door entrance to 707 W. Harrison St. (south side of Harrison St., approx. 90' west of west line of Des Plaines St.). Elevation 597.47.

Existing Structure: S.N. 016-2453 was originally constructed in 1960 as an eight-span structure carrying one lane of traffic from eastbound I-290 to northbound I-90/94 (FAI Route No. 94; Section 0101.6-1P). Rehabilitation was performed under various contracts including removal and replacement of the Spans 1 thru 3 superstructure (from existing Bent 26 to Abutment 29), Piers 2 and 28, and the Abutment 29 backwall in 1987. The bridge has an overall length of approximately 429'-0" (41'-8 3/8" / 70'-5 3/8" / 53'-11 1/2" / 49'-0 5/8" / 54'-2 5/8" / 79'-5 13/16" / 40'-9 1/2" / 40'-0" spans), an overall width of 29'-0" (out-to-out superstructure) and consists of a minimum 7 1/2"-thick reinforced concrete deck with overlay supported on five (5) steel girders. The existing substructure consists of reinforced concrete piers and abutments on drilled shafts. This structure will be removed and replaced. Traffic will be detoured during construction.

HIGHWAY CLASSIFICATION

Ramp EN	I-90/94 SB at Van Buren
Functional Class: Interstate	Functional Class: Interstate
ADT: 26,600 (2012); 31,000 (2040)	ADT: 100,100 (2012); 98,000 (2040)
ADTT: 1,032 (2012); 1,203 (2040)	ADTT: 11,351 (2012); 11,113 (2040)
DHV: 1,910 (2040)	DHV: 6,340 (2040)
Design Speed: 30 m.p.h.	Design Speed: 60 m.p.h.
Posted Speed: 30 m.p.h.	Posted Speed: 45 m.p.h.
One-Way Traffic	One-Way Traffic
Directional Distribution: 100%	Directional Distribution: 100%

DESIGN SPECIFICATIONS

2014 AASHTO LRFD Bridge Design Specifications, 7th Edition with 2015 and 2016 Interim Revisions

LOADING HL-93

Allow 50#/sq. ft. for future wearing surface.

DESIGN STRESSES

FIELD UNITS

f'c = 3,500 psi
 f'c = 4,000 psi (Superstructure Concrete)
 fy = 60,000 psi (Reinforcement)
 fy = 50,000 psi (M270 Grade 50)

SEISMIC DATA

Seismic Performance Zone (SPZ) = 1
 Design Spectral Acceleration at 1.0 sec. (SD1) = 0.085g
 Design Spectral Acceleration at 0.2 sec. (SDS) = 0.144g
 Soil Site Class = D

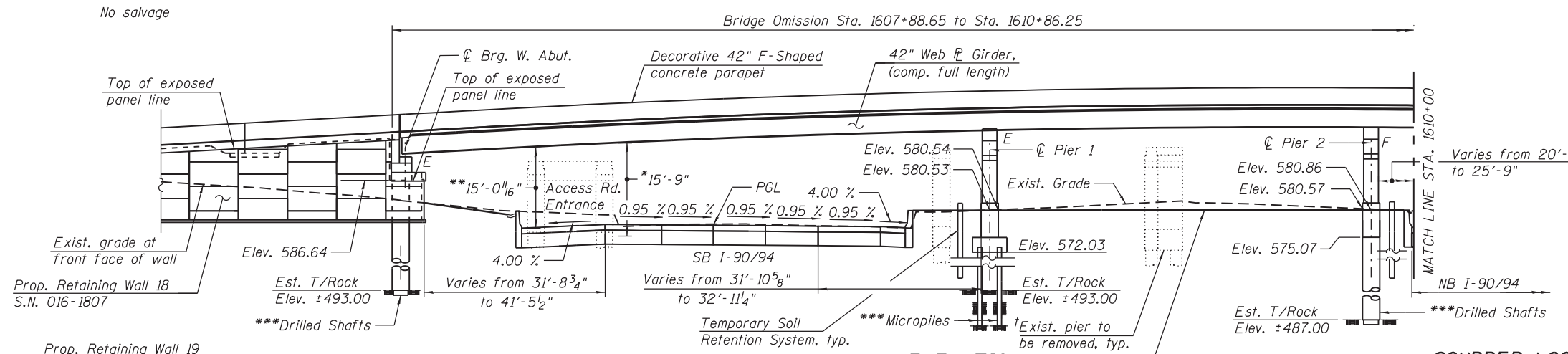

SCUPPER LOCATION

Station	Offset
1608+00.82	24.00' Lt.
1608+06.20	24.00' Lt.
1610+79.78	24.00' Lt.
1610+85.16	24.00' Lt.

ELEVATION

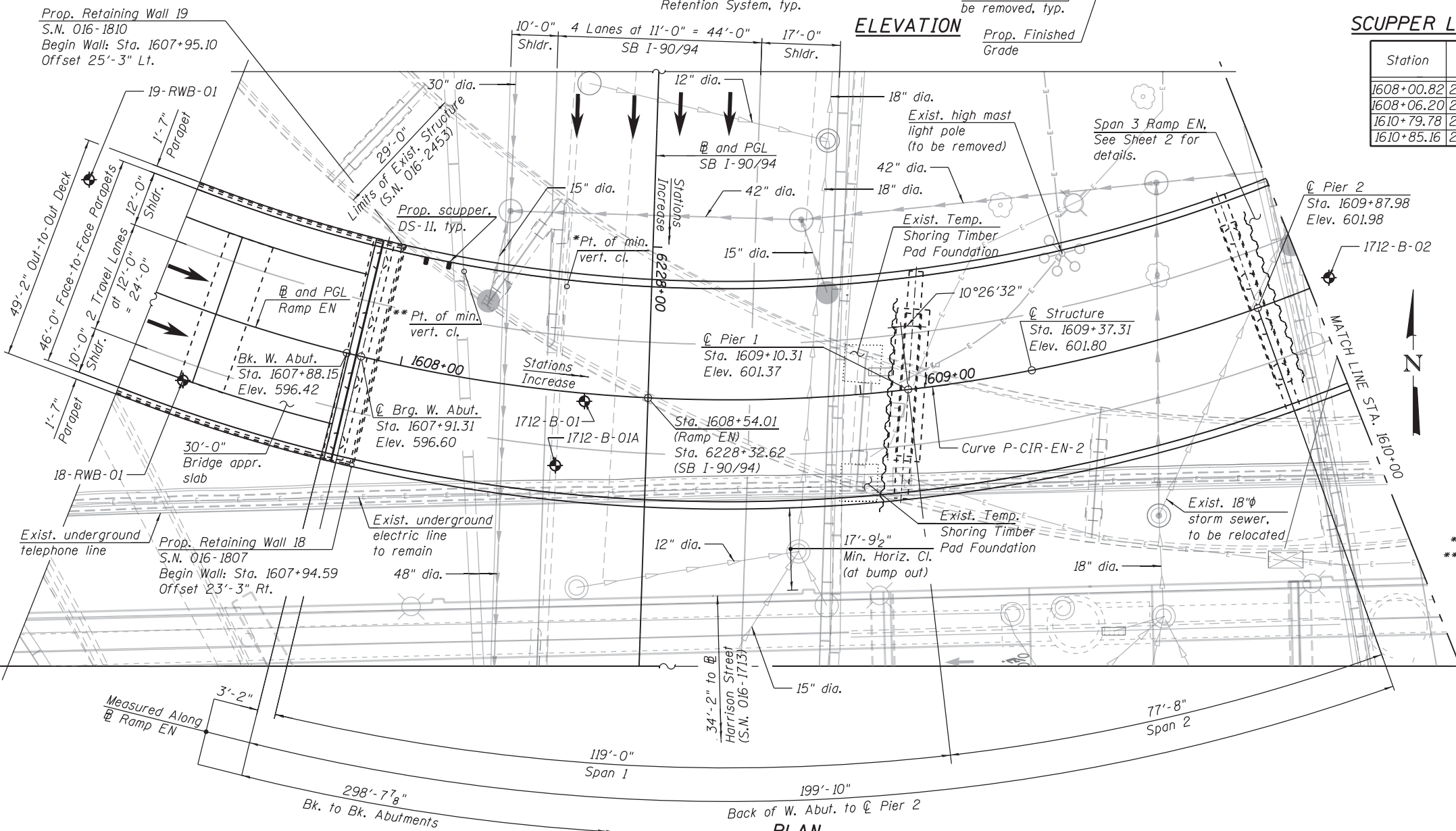

LEGEND:

- Soil Boring
- Exist. High Mast Light Pole (to be removed)
- Exist. Traffic Signal/Light Pole (to be removed)
- Fire Hydrant
- Junction Box
- Manhole
- Temporary Soil Retention System
- Combined Sewer
- Electric
- Fiber Optic
- Exist. Storm Sewer
- Prop. Storm Sewer
- Water Line
- Telephone
- Range 14E, 3rd P.M.

* Interim Min. Vert. Cl.
 ** Final Min. Vert. Cl.
 *** Spacing, tip elevation, and drilled shaft/micropile diameter to be determined during final design.
 † Only exist. piers interfering with proposed superstructure have been presented for clarity

LOCATION SKETCH

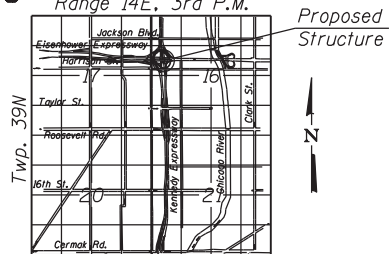

GENERAL PLAN & ELEVATION - 1

RAMP EN OVER F.A.I. RTE. 90/94

(DAN RYAN EXPRESSWAY)

F.A.I. RTE. 90/94/290 - SECTION 2014-005R&B

COOK COUNTY

STATION 1609+37.31

STRUCTURE NO. 016-1712

HBM
 ENGINEERING GROUP, LLC
 CONSULTING & DESIGN
 INSPECTION & RATING
 RESEARCH & TESTING

4415 WEST HARRISON ST.
 SUITE 231
 HILLSIDE, IL 60162
 PHONE: (708) 236-0900
 FAX: (708) 236-0901

USER NAME = Kendrabant
 DESIGNED - MI, JJS
 DRAWN - JJS, WM
 CHECKED - MAI, MI
 DATE - 04/19/2017
 REVISED -
 REVISED -
 REVISED -
 REVISED -

STATE OF ILLINOIS
 DEPARTMENT OF TRANSPORTATION

STRUCTURE NO. 016-1712

SCALE: SHEET 1 OF 4 SHEETS STA. TO STA.

F.A.I. RTE.	SECTION	COUNTY	TOTAL SHEETS	SHEET NO.
90/94/290	2014-005R&B	COOK	4	1
CONTRACT NO. 60X79			ILLINOIS FED. AID PROJECT	

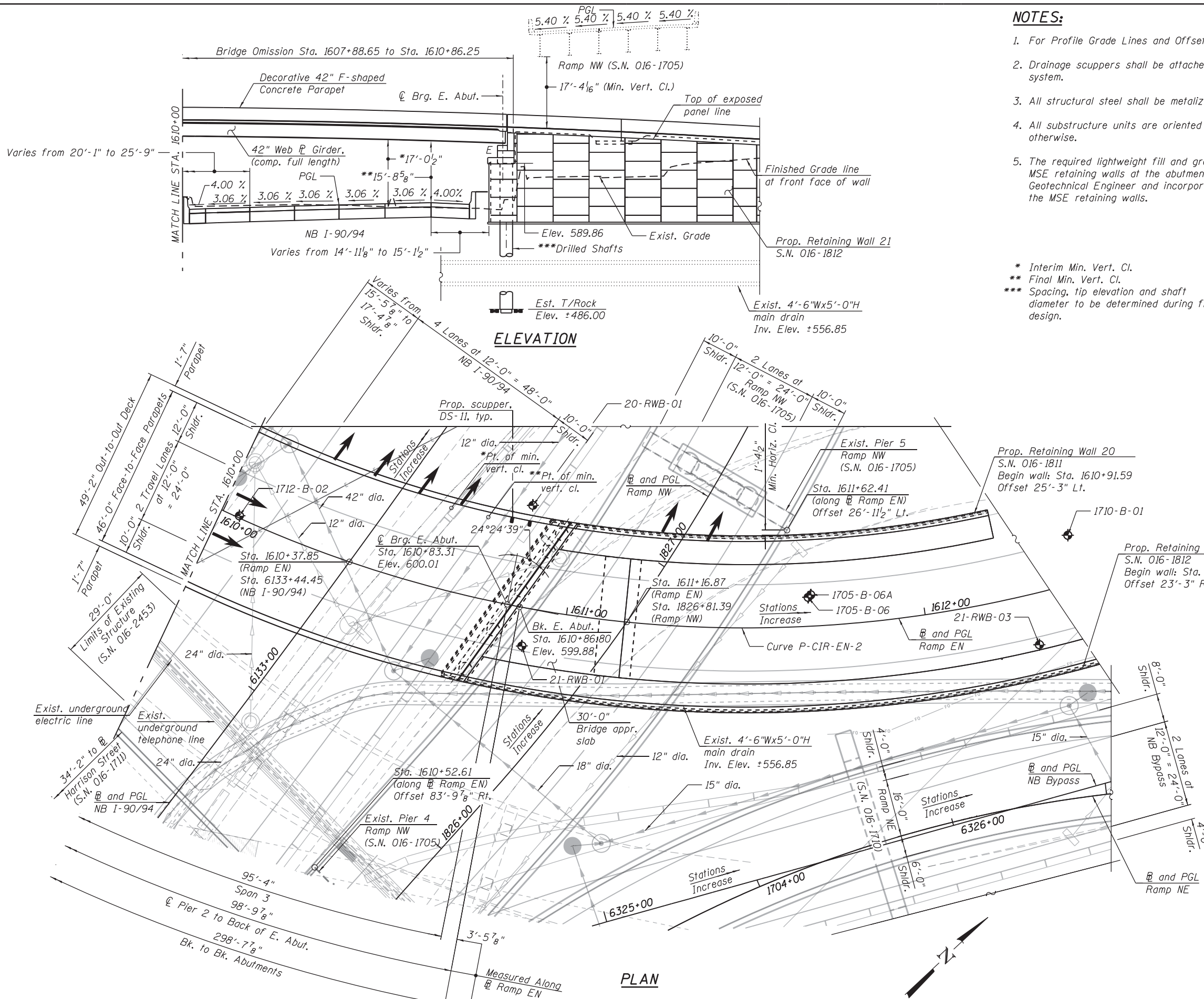

NOTES:

1. For Profile Grade Lines and Offset Sketch, see Sheet 4 of 4.
2. Drainage scuppers shall be attached to a closed drainage system.
3. All structural steel shall be metalized (thermal spraying).
4. All substructure units are oriented 90° to \bar{E} unless noted otherwise.
5. The required lightweight fill and ground improvements for the MSE retaining walls at the abutments will be determined by the Geotechnical Engineer and incorporated into the TSL plans for the MSE retaining walls.

- * Interim Min. Vert. Cl.
- ** Final Min. Vert. Cl.
- *** Spacing, tip elevation and shaft diameter to be determined during final design.

HIGHWAY CLASSIFICATION

Ramp NW
 Functional Class: Interstate
 ADT: 32,500 (2012); 36,000 (2040)
 ADTT: 2,483 (2012); 2,730 (2040)
 DHV: 2,790 (2040)
 Design Speed: 35 m.p.h.
 Posted Speed: 35 m.p.h.
 One-Way Traffic
 Directional Distribution: N/A

Ramp NE
 Functional Class: Interstate
 ADT: 3,100 (2012); 4,000 (2040)
 ADTT: 42 (2012); 55 (2040)
 DHV: 280 (2040)
 Design Speed: 30 m.p.h.
 Posted Speed: 30 m.p.h.
 One-Way Traffic
 Directional Distribution: NA

NB Bypass
 Functional Class: Interstate
 ADT: NA (2012); 17,000 (2040)
 ADTT: NA (2012); 442 (2040)
 DHV: 1,680 (2040)
 Design Speed: 30 m.p.h.
 Posted Speed: 30 m.p.h.
 One-Way Traffic
 Directional Distribution: NA

LEGEND:

- Soil Boring
- Exist. High Mast Light Pole (to be removed)
- Exist. Traffic Signal/Light Pole (to be removed)
- Fire Hydrant
- Junction Box
- Manhole
- Combined Sewer
- Electric
- Fiber Optic
- Exist. Storm Sewer
- Prop. Storm Sewer
- Water Line
- Telephone

GENERAL PLAN & ELEVATION - 2
RAMP EN OVER F.A.I. RTE. 90/94
(DAN RYAN EXPRESSWAY)
F.A.I. RTE. 90/94/290 - SECTION 2014-005R&B
COOK COUNTY
STATION 1609+37.31
STRUCTURE NO. 016-1712

FILE PATH = p:\161749-P\MINT\pccom\line\local\016-1712-005R&B\Structure\16-1712-0161712-6000-000-TSL-002

HBM
 ENGINEERING GROUP, LLC.
 CONSULTING & DESIGN
 INSPECTION & RATING
 RESEARCH & TESTING

4415 WEST HARRISON ST.
 SUITE 231
 HILLSIDE, IL 60162
 PHONE: (708) 236-0900
 FAX: (708) 236-0901

USER NAME = Kandrabant	DESIGNED - MI, JJS	REVISED -
	DRAWN - JJS, WM	REVISED -
PLOT SCALE = 28:0' = 1" = 1/8"	CHECKED - MAI, MI	REVISED -
PLOT DATE = 4/17/2017	DATE - 04/19/2017	REVISED -

STATE OF ILLINOIS
DEPARTMENT OF TRANSPORTATION

STRUCTURE NO. 016-1712
 SCALE: SHEET 2 OF 4 SHEETS STA. TO STA.

F.A.I. RTE. 90/94/290	SECTION 2014-005R&B	COUNTY COOK	TOTAL SHEETS 4	SHEET NO. 2
CONTRACT NO. 60X79			ILLINOIS FED. AID PROJECT	

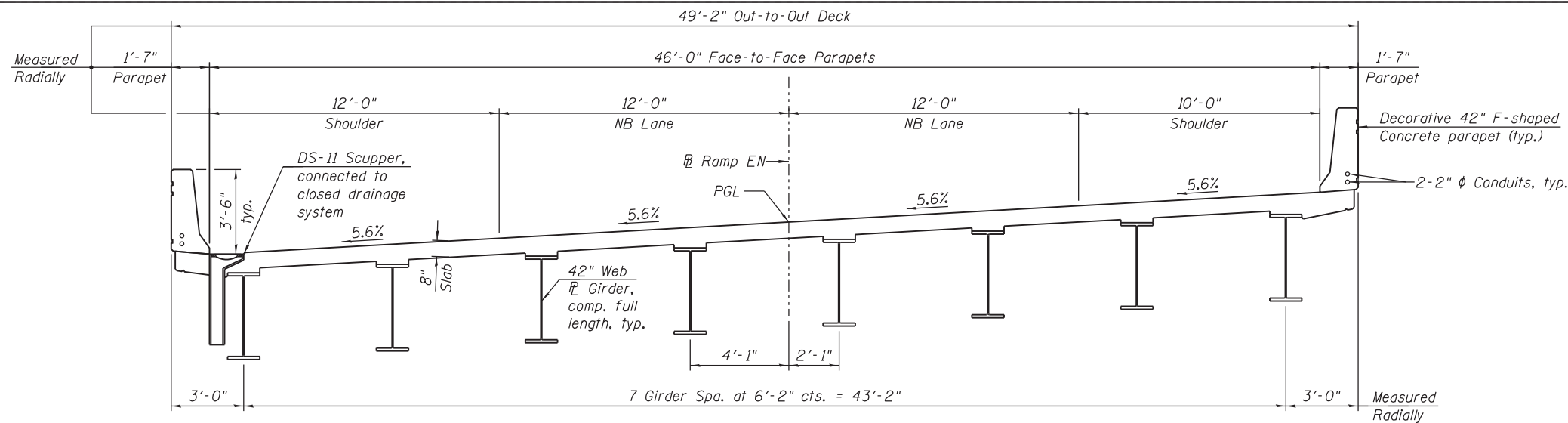

CROSS SECTION
(Looking Up-station)

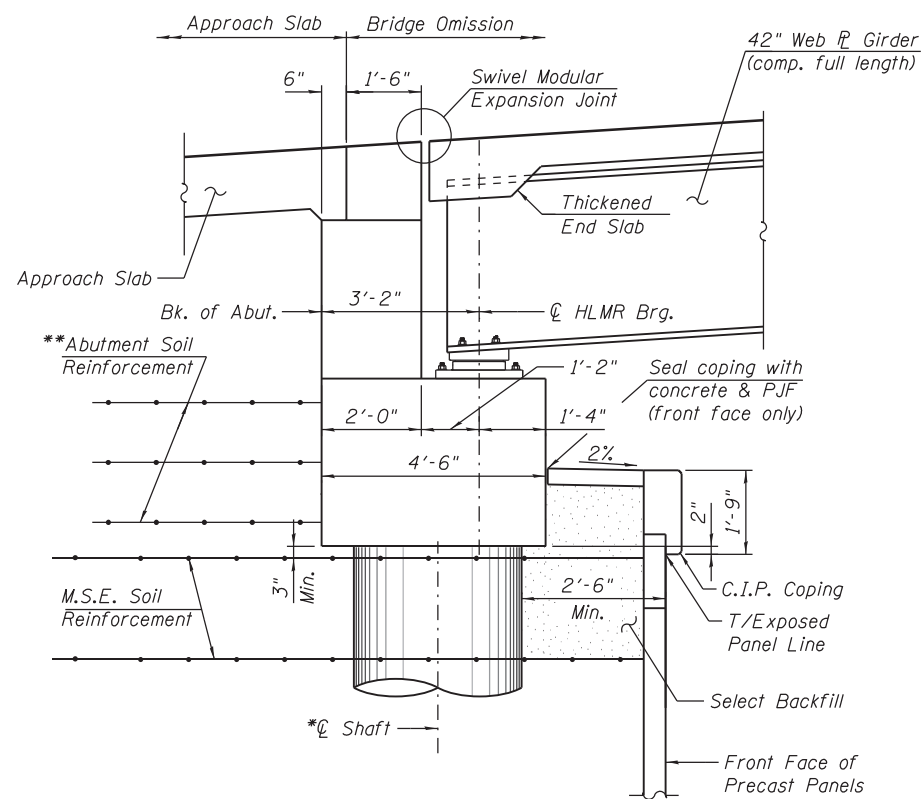

SECTION THRU ABUTMENTS

(Horiz. Dims. @ Rt. L's to C/Brg.)
(W. Abut. shown; E. Abut. opposite hand)

*Size, spacing & no. to be determined in design

**Abutment Soil Reinforcement to resist lateral loads in lieu of drilled shafts

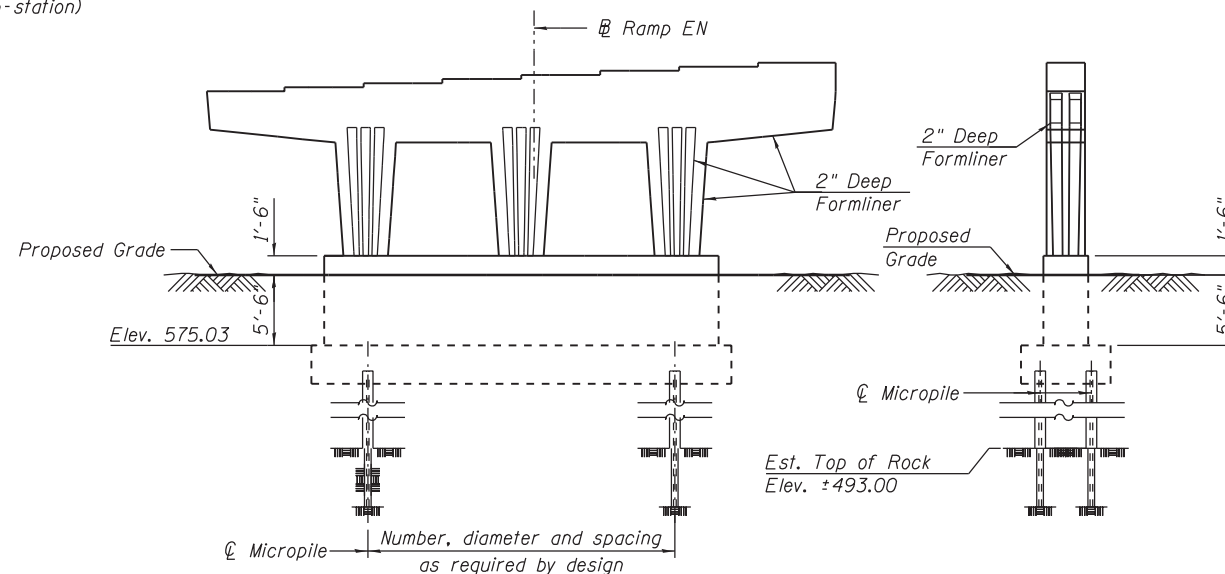

PIER 1 SKETCH
(Looking Up-station)

END VIEW

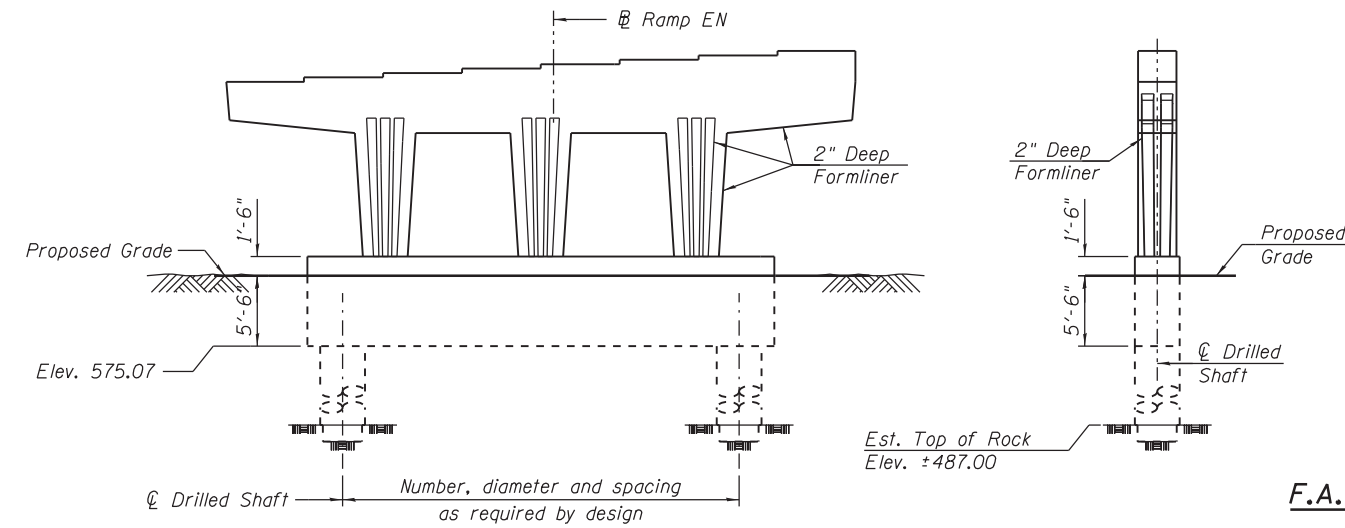

PIER 2 SKETCH
(Looking Up-station)

END VIEW

NOTES:

1. For Notes, See Sheet 2.

SECTIONS & DETAILS
RAMP EN OVER F.A.I. RTE. 90/94
(DAN RYAN EXPRESSWAY)
F.A.I. RTE. 90/94/290 - SECTION 2014-005R&B
COOK COUNTY
STATION 1609+37.31
STRUCTURE NO. 016-1712

FILE PATH = p:\617479-PM\INT.\p\016-1712-0161712-0000-000-TS1-003

HBM
ENGINEERING GROUP, LLC
CONSULTING & DESIGN
INSPECTION & RATING
RESEARCH & TESTING

4415 WEST HARRISON ST.
SUITE 231
HILLSIDE, IL 60162
PHONE: (708) 236-0900
FAX: (708) 236-0901

USER NAME = Ken.drabant	DESIGNED - MI, JJS	REVISED -
	DRAWN - WM, LAB	REVISED -
PLOT SCALE = 6:0.0000 "1" = 1"	CHECKED - MAI, MI	REVISED -
PLOT DATE = 4/17/2017	DATE - 04/19/2017	REVISED -

STATE OF ILLINOIS
DEPARTMENT OF TRANSPORTATION

STRUCTURE NO. 016-1712
SCALE: SHEET 3 OF 4 SHEETS STA. TO STA.

F.A.I. RTE. 90/94/290	SECTION 2014-005R&B	COUNTY COOK	TOTAL SHEETS 4	SHEET NO. 3
CONTRACT NO. 60X79				ILLINOIS FED. AID PROJECT

Location	A
☉ Brg. W. Abut.	33°08'30"
☉ Pier 1	23°31'49"
☉ Pier 2	00°00'00"
☉ Brg. E. Abut.	08°20'44"

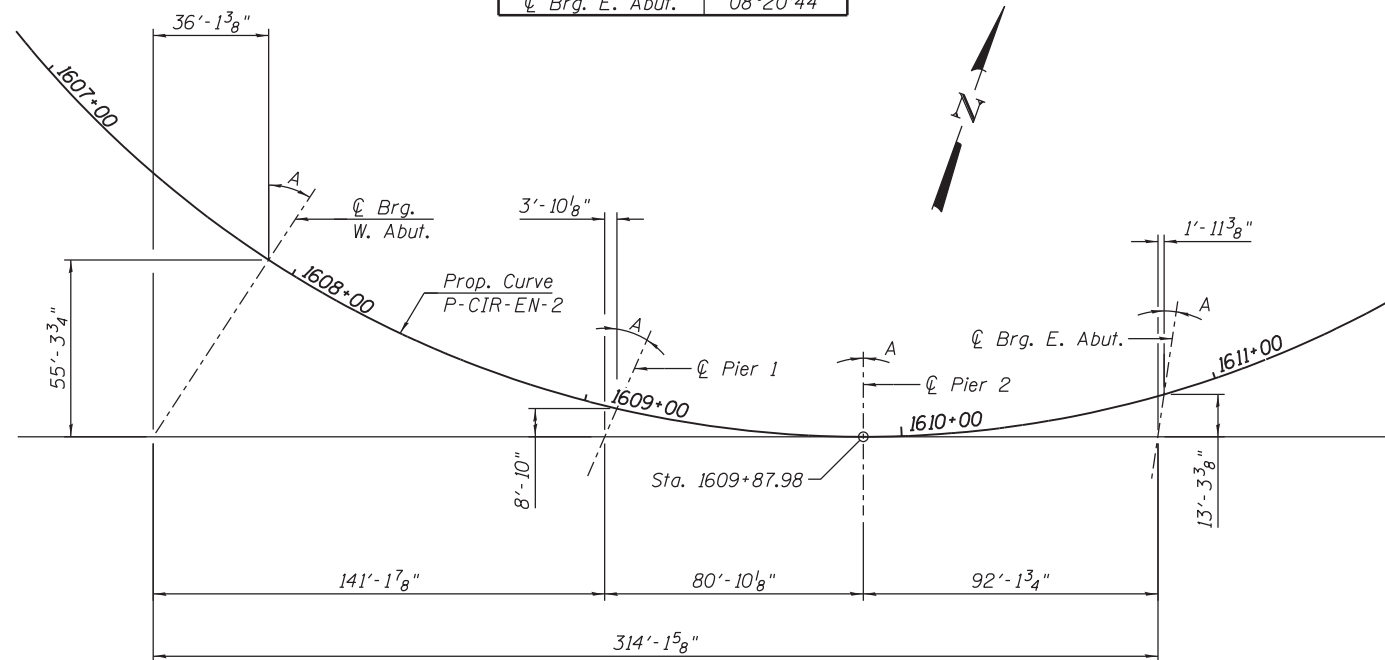

OFFSET SKETCH

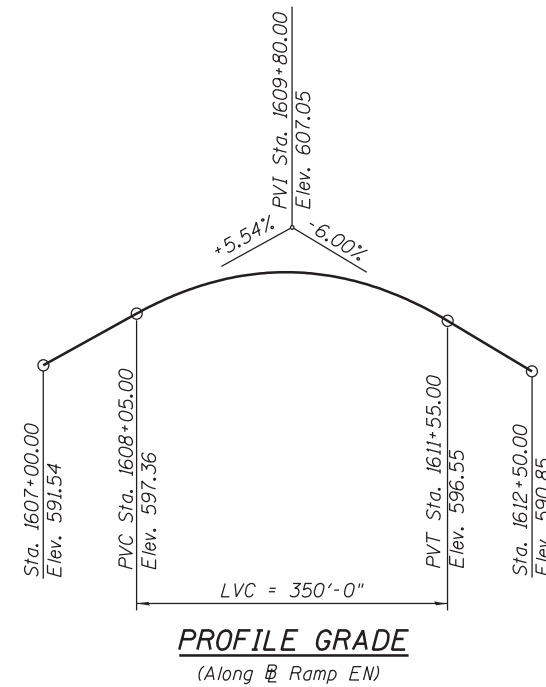

CURVE DATA
(RAMP EN)
(PROP. CURVE P-CIR-EN-2)
PI STA. = 1624+41.43
 $\Delta = 158^\circ 32' 09''$ (LT)
 $D = 16^\circ 51' 06''$
 $R = 340.00'$
 $T = 1,793.89'$
 $L = 940.77'$
 $E = 1,485.82'$
 $e = 5.60\%$
 $T.R. = 36'$
 $S.E. RUN = 102'$
 $P.C. STA. = 1606+47.54$
 $P.T. STA. = 1615+88.31$
 $DS = 30$
 $PS = 30$

PROFILE GRADE
(Along ☉ Ramp EN)

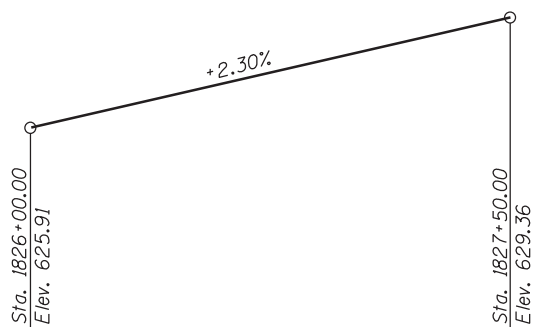

PROFILE GRADE
(Along ☉ Ramp NW)

CURVE DATA
(RAMP NW)
(PROP. CURVE P-CIR-NW-6)
P.I. Sta. = 1831+44.22
 $\Delta = 88^\circ 30' 25''$ (LT)
 $D = 10^\circ 36' 37''$
 $R = 540.00'$
 $T = 526.11'$
 $L = 834.16'$
 $E = 213.92'$
 $e = 5.40\%$
 $T.R. = 39'$
 $S.E. Run = 105'$
 $P.C. Sta. = 1826+18.11$
 $P.T. Sta. = 1834+52.27$
 $DS = 35$
 $PS = 35$

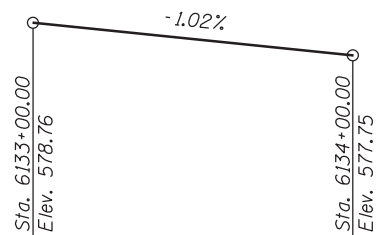

PROFILE GRADE
(Along ☉ NB I-90/94)

CURVE DATA
(NB I-90/94)
(PROP. CURVE P-KDR-NB-3)
PI STA. = 6129+99.47
 $\Delta = 11^\circ 38' 44''$ (LT)
 $D = 1^\circ 33' 16''$
 $R = 3,686.00'$
 $T = 375.89'$
 $L = 749.19'$
 $E = 19.12'$
 $e = 3.80\%$
 $T.R. = 107'$
 $S.E. RUN = 204'$
 $P.C. STA. = 6126+23.58$
 $P.T. STA. = 6133+72.77$
 $DS = 60$
 $PS = 45$

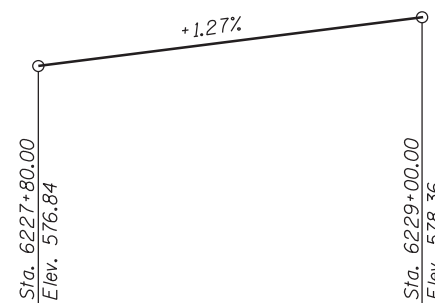

PROFILE GRADE
(Along ☉ SB I-90/94)

CURVE DATA
(SB I-90/94)
(PROP. CURVE P-KDR-SB-4)
PI STA. = 6231+84.46
 $\Delta = 13^\circ 18' 21''$ (LT)
 $D = 2^\circ 44' 34''$
 $R = 2,089.00'$
 $T = 243.66'$
 $L = 485.13'$
 $E = 14.16'$
 $e = 4.40\%$
 $T.R. = NA$
 $S.E. RUN = 164'$
 $P.C. STA. = 6229+40.80$
 $P.T. STA. = 6234+25.93$
 $DS = 60$
 $PS = 45$

OFFSET SKETCH, PROFILE GRADE LINES AND CURVE DATA
RAMP EN OVER F.A.I. RTE. 90/94
(DAN RYAN EXPRESSWAY)
F.A.I. RTE. 90/94/290 - SECTION 2014-005R&B
COOK COUNTY
STATION 1609+37.31
STRUCTURE NO. 016-1712

FILE PATH = p:\617479-PM\INT.\p\com\line\local\HRCM_D592_NA\Documents\01_Americas\T.\engp\station\602695938_Circle\Phase_1\000_CAD\008_Structural\Brdg_016-1712_0161712-60000-000-TSL-004

HBM
ENGINEERING GROUP, LLC
CONSULTING & DESIGN
INSPECTION & RATING
RESEARCH & TESTING

4415 WEST HARRISON ST.
SUITE 231
HILLSIDE, IL 60162
PHONE: (708) 236-0900
FAX: (708) 236-0901

USER NAME = Ken.drabant	DESIGNED - MI, JJS	REVISED -
	DRAWN - WM, MA	REVISED -
PLOT SCALE = 60.0000' / in.	CHECKED - MAI, MI	REVISED -
PLOT DATE = 4/17/2017	DATE - 04/19/2017	REVISED -

STATE OF ILLINOIS
DEPARTMENT OF TRANSPORTATION

STRUCTURE NO. 016-1712

SCALE: SHEET 4 OF 4 SHEETS STA. TO STA.

F.A.I. RTE.	SECTION	COUNTY	TOTAL SHEETS	SHEET NO.
90/94/290	2014-005R&B	COOK	4	4
CONTRACT NO. 60X79			ILLINOIS FED. AID PROJECT	