**STRUCTURE GEOTECHNICAL REPORT
CIRCLE INTERCHANGE RECONSTRUCTION
RETAINING WALL 18 (PROPOSED SN 016-1807)
F.A.I ROUTE 90/94/290
IDOT D-91-227-13/ PTB 163-001
COOK COUNTY, ILLINOIS**

**For
AECOM
303 East Wacker Drive
Chicago, IL 60601
(312) 938-0300**

**Submitted by
Wang Engineering, Inc.
1145 North Main Street
Lombard, IL 60148
(630) 953-9928**

**Original: September 22, 2017
Revised: March 8, 2018**

Technical Report Documentation Page

1. Title and Subtitle Structure Geotechnical Report Circle Interchange Reconstruction Retaining Wall 18, F.A.I. Route 90/94/290 Station 1605+00.00 to Station 1607+99.89		2. Report Date Original: September 22, 2017 Revised: March 8, 2018
		3. Report Type <input checked="" type="checkbox"/> SGR <input type="checkbox"/> RGR <input type="checkbox"/> Draft <input checked="" type="checkbox"/> Final <input checked="" type="checkbox"/> Revised
4. Route / Section / County FAI 94/90/290/2014-005R&B / Cook		5. IDOT Job No./Contract D-91-259-12/60X79
6. PTB / Item No. 163/001	7. Existing Structure Number(s) No existing wall	8. Proposed Structure Number(s) 016-1807
9. Prepared by Wang Engineering, Inc. 1145 N Main Street Lombard, IL 60148	Contributor(s) Author: Metin W. Seyhun, P.E. QC/QA: Mohammed Kothawala, P.E., D.GE. PIC: Corina T. Farez, P.E., P.G.	Author Phone Number/Email Address (630) 953-9928 Ext 1018 mseyhun@wangeng.com
10. Prepared for AECOM 303 East Wacker Drive Chicago, IL 60601	Structural Engineer John Saraceno, P.E., S.E. HBM Engineering Group, LLC.	Contact Phone Number (708) 236-0900
11. Abstract A 451.8-foot long, 12.4 feet maximum retained height new Mechanically Stabilized Earth (MSE) walls will be constructed along back-to-back and extended sections to retain the proposed Ramp EN Bridge west approach. The proposed back-to-back fill MSE wall wraps around the proposed west abutment of Ramp EN Bridge. This report provides geotechnical recommendations for the design and construction of the proposed retaining walls. Beneath the pavement or topsoil, the subsurface soils consists of up to 5 feet of fill materials, up to 5 feet medium stiff to stiff silty clay crust, up to 41 feet of very soft to medium stiff silty clay, 20 feet of very stiff to hard clay loam, and 30 feet of hard silty clay loam or dense to very dense silt to silty loam and sand extending to the boring termination depths or weathered bedrock. Sound bedrock was encountered at elevations of about 489 to 491 feet. Groundwater was encountered within the fill layers at elevations of 570 to 574 feet. Based on the encountered subsoil conditions and the wall height, the proposed back-to-back MSE wall is feasible and will require Class III LCCF as MSE wall fill material as well as fill materials between back-to-back walls. We estimate the wall will have a maximum factored bearing resistance of 2,100 psf using a geotechnical resistance factor of 0.65. The maximum long-term consolidation settlement of foundation soils is estimated to be 1 inch or less. For the extended portion of South MSE wall, To minimize the excavation behind the wall between Stations 1605+00.00 and 1607+00.00, we recommend using Class III LCCF with 0.7 H reinforcement width. It should be noted that the normal weight portion of the overall embankment behind the wall system be laid back so it does not exert any earth pressure on the LCCF backfill that is to be placed behind the LCCF MSE Mass.		
12. Path to archived file S:\Netprojects\11000401\Reports\SGRs\Walls\1807 Wall 18\V03_RevisedFinal_PDF\RPT_Wang_MWS_11000401SGRRevFinalWall18_20180308.doc		

TABLE OF CONTENTS

1.0	INTRODUCTION.....	1
1.1	PROJECT DESCRIPTION	1
1.2	PROPOSED STRUCTURE	2
1.3	EXISTING STRUCTURE.....	2
2.0	SITE CONDITIONS AND GEOLOGICAL SETTING.....	2
2.1	PHYSIOGRAPHY	3
2.2	SURFICIAL COVER	3
2.3	BEDROCK	3
3.0	METHODS OF INVESTIGATION.....	4
3.1	SUBSURFACE INVESTIGATION	4
3.2	VANE SHEAR TESTS	5
3.3	LABORATORY TESTING	5
4.0	RESULTS OF FIELD AND LABORATORY INVESTIGATIONS	5
4.1	SOIL CONDITIONS.....	5
4.2	GROUNDWATER CONDITIONS	7
4.3	SEISMIC DESIGN CONSIDERATIONS.....	8
5.0	ANALYSIS AND RECOMMENDATIONS	8
5.1	RETAINING WALL TYPE EVALUATION.....	8
5.2	BACK-TO-BACK MSE WALL SECTION.....	9
5.2.1	<i>Bearing Resistance and External Stability Analyses</i>	9
5.2.2	<i>Settlement Analyses</i>	10
5.2.3	<i>Global Stability Analyses.....</i>	10
5.3	EXTENDED SOUTH MSE WALL SECTION.....	10
5.3.1	<i>Bearing Resistance and External Stability Analyses</i>	11
5.3.2	<i>Settlement Analyses</i>	12
5.3.3	<i>Global Stability Analyses.....</i>	12
6.0	CONSTRUCTION CONSIDERATIONS	12
6.1	EXCAVATION.....	12
6.2	DEWATERING	12

6.3	FILLING AND BACKFILLING.....	12
6.4	MSE WALL CONSTRUCTION.....	13
6.5	CONSTRUCTION MONITORING.....	13
7.0	QUALIFICATIONS.....	13
	REFERENCES	14
	EXHIBITS	
	1. <i>Site Location Map</i>	
	2. <i>Site and Regional Geology</i>	
	3. <i>Boring Location Plan</i>	
	4. <i>Subsurface Soil Data Profile</i>	
	APPENDIX A	
	<i>Boring Logs and Rock Core Photographs</i>	
	APPENDIX B	
	<i>Laboratory Test Results</i>	
	APPENDIX C	
	<i>Global Stability Analysis Results</i>	
	APPENDIX D	
	<i>Type Size Location Plan</i>	
	APPENDIX E	
	<i>Cross-Section Drawings</i>	

**STRUCTURE GEOTECHNICAL REPORT
CIRCLE INTERCHANGE RECONSTRUCTION
RETAINING WALL 18 (PROPOSED SN 016-1807)
F.A.I. ROUTE 94 (I-290 WB TO I-90/94 SB)
IDOT D-91-227-13/PTB 163-001
COOK COUNTY, ILLINOIS
FOR
AECOM**

1.0 INTRODUCTION

This report presents the results of Wang Engineering, Inc. (Wang) subsurface investigation, laboratory testing, geotechnical engineering evaluations and recommendations for a new retaining wall, designated as SN 016-1807 (Retaining Wall 18) proposed along the west approach of Ramp EN Bridge (SN 016-1715) in connection with the Circle Interchange Reconstruction project in the City of Chicago, Cook County, Illinois. A *Site Location Map* is presented as Exhibit 1.

The purpose of our investigation was to characterize the site soil and groundwater conditions, perform geotechnical engineering analyses, and provide recommendations for the design and construction of the new wall structure.

1.1 Project Description

The Circle Interchange is over 50 years old and has significant congestion and safety problems. The project is aiming to improve safety and mobility as well as upgrade the mainline and interchange facilities. The project will also improve other modes of transportation such as transit, pedestrians and bicyclists within the same corridor.

The Circle Interchange Reconstruction project is along Interstate 90/94 (I-90/94) from south of Roosevelt Road to north of Lake Street, along Interstate 290 (I-290) from Loomis Street to the Circle Interchange; and along Congress Parkway from the Circle Interchange to Canal Street/Old Post Office. The routes typically have three lanes of traffic in each direction with mostly one lane ramp at interchanges. Locally, the north leg is known as the Kennedy Expressway, the south leg as the Dan Ryan Expressway and the west leg as the Eisenhower Expressway. Within the project area, there are

several cross street bridges over I-90/94 and I-290 considered for reconstruction. Along I-90/94, from south to north, the cross street overpasses include Taylor Street, Van Buren Street, Jackson Boulevard, and Adams Street. Along I-290, from west to east, the cross street overpasses include Morgan Street, Peoria Street, and Halsted Street.

The proposed improvements include additional through lanes in each direction on I-90/94. The horizontal alignment and vertical profiles throughout the interchange will be improved. A new two-lane flyover, Ramp NW (Flyover) will be constructed for I-90/94 northbound to I-290 westbound traffic. Cross street bridges, Morgan Street, Harrison Street, Halsted Street, Peoria Street, Taylor Street, Adams Street, Jackson Boulevard, and Van Buren Street will be reconstructed. Various existing ramps will be reconstructed and up to fifty new retaining walls will be constructed.

1.2 Proposed Structure

Retaining wall 18 (SN 016-1807) is proposed to support the west approach of the Ramp EN Bridge. Based on the Type, Size, and Location (TSL) plan dated September 22, 2017 provided by HBM Engineering Group, Inc. (HBM), the wall is proposed to be a Mechanically Stabilized Earth (MSE) wall. The 310.3-foot long south MSE wall begins at Station 1605+00.00 on south side of Ramp EN and ends at Station 1607+99.89. The 93-foot long north MSE wall begins at Station 1607+00, and ends at Station 1608+00.47 on the north side. The MSE wall will have a maximum retained height of 12.4 feet. There will be a 3.5-foot concrete parapet on top of the MSE wall. The TSL plan is included in the *Appendix C*.

1.3 Existing Structure

There is no existing retaining wall structure due to a new alignment of Ramp EN Bridge.

2.0 SITE CONDITIONS AND GEOLOGICAL SETTING

The site is located within the City of Chicago at the I-90/94 and I-290 Circle Interchange. On the USGS *Chicago Loop 7.5 Minute Series* map, the wall is located in the NW $\frac{1}{4}$ of Section 16, Tier 39 N, Range 14 E of the Third Principal Meridian.

The following review of published geologic data, with emphasis on factors that might influence the design and construction of the proposed engineering works, is meant to place the project area within a geological framework and confirm the dependability and consistency of the present subsurface

investigation results. For the study of the regional geologic framework, Wang considered northeastern Illinois in general and Cook County in particular. Exhibit 2 illustrates the *Site and Regional Geology*.

2.1 Physiography

The wall is situated within the Chicago Lake Plain Physiographic Subsection. The area is characterized by a flat surface that slopes gently toward the lake, largely made of groundmoraine till covered by thin and discontinuous lacustrine silt and clay. The ground elevation along the wall ranges from 574 feet at the west end to 582 feet at the east end.

2.2 Surficial Cover

The project area was shaped during the Wisconsin-age glaciation, and more than 75-foot thick drift covers the bedrock (Leetaru et al. 2004). The glacial cover is made up of clay and silt of the Equality Formation of the Mason Group and diamictons of the Wadsworth and Lemont Formations of the Wedron Group (Hansel and Johnson 1996). The Equality Formation is made up of bedded silt and clay, locally laminated, with lenses and/or thin beds of sand and gravel. The Wadsworth Formation consists of relatively homogenous, massive, gray till with clay to silty clay matrix, with dolostone and shale clasts and occasional lenses of sorted and stratified silt. The Wadsworth Formation is underlain by the pebbly silty clay loam to silty loam diamicton of the Yorkville Member of the Lemont Formation, known informally as the Chicago “hardpan.”

From a geotechnical viewpoint, the Equality Formation is characterized by low strength, medium to high plasticity, and medium to high moisture content, whereas the Wadsworth Formation is characterized by low plasticity, medium to low moisture content, medium to very stiff consistency, poor permeability, and low compressibility. The Yorkville Member (hardpan) is characterized by low plasticity, high blow counts, and low moisture content (Bauer et al. 1991; Peck and Reed 1954).

2.3 Bedrock

In the project area, the glacial deposits unconformably rest over approximately 350-foot thick Silurian-age dolostone (Leetaru et al 2004). The top of bedrock may be encountered at 475 to 500 feet elevation or 75 to 100 feet below ground surface (bgs) or more. The Silurian dolostone dips gently eastward at a pace of 15 feet per mile. Only inactive faults are known in the area, and the seismic risk is minimal (Leetaru et al. 2004; Willman 1971). There are no records of mining activity in the area, but deep tunnel excavations are known to exist.

Our subsurface investigation results fit into the local geologic context. The borings drilled in the project area revealed the native sediments consist of clay to silty clay diamicton of the Wadsworth Formation resting on top of more competent silty clay loam diamicton (hardpan) of the Lemont Formation, which in turn is underlain by bedrock. Sound dolostone bedrock was sampled at depths of 87 to 89 feet bgs, corresponding to 488.8 to 490.5 feet elevations, within the range predicted based on published geological data.

3.0 METHODS OF INVESTIGATION

The following sections outline the subsurface and laboratory investigations. All elevations in this report are based on NAVD 1988.

3.1 Subsurface Investigation

Wang drilled four structure borings, designated as 18-RWB-01 through 18-RWB-03 and 19-RWB-01 in October, 2013. Wang has also referenced three nearby structure borings, designated as 1087-B-02, and 1712-B-01 drilled in March to October, 2013. The as-drilled boring locations were surveyed by Dynasty Group, Inc. and station and offset information for each boring were provided by AECOM. Boring location data are presented in the *Boring Logs* (Appendix A). The as-drilled boring locations are shown in the *Boring Location Plan* (Exhibit 3).

ATV- and truck-mounted drilling rigs equipped with hollow stem augers, were used to advance and maintain an open borehole to 10 to 15 feet depths after that mud rotary was used to the boring termination depth. Soil sampling was performed according to AASHTO T 206, "*Penetration Test and Split Barrel Sampling of Soils*." The soil was sampled at 2.5-foot intervals to 30 feet bgs and at 5-foot intervals to boring termination depths. Soil samples collected from each sampling interval were placed in sealed jars and transported to Wang Geotechnical Laboratory in Lombard, Illinois for further examination and laboratory testing.

Field boring logs, prepared and maintained by a Wang engineer or geologist, include lithological descriptions, visual-manual soil/rock classifications, results of Rimac and pocket penetrometer unconfined compressive strength tests, results of Standard Penetration Tests (SPT) recorded as blows per 6 inches of penetration. The SPT N value, shown on the soil profile, is the sum of the second and third blows per 6 inches. The soils were described and classified according to Illinois Division of

Highways (IDH) Textural Classification system. The field logs were finalized by an experienced engineering geologist after verifying the field visual classifications and laboratory test results.

Groundwater observations were made during drilling to depths of 10 to 15 feet before using rotary wash method. Due to safety considerations, boreholes were backfilled with grout immediately upon completion.

3.2 Vane Shear Tests

Wang performed vane shear tests in Borings 1729-VST-01, 1729-VST-02, and VST-01 conducted 250 to 500 feet south of the Wall 18. Vane shear tests were performed in undisturbed and remolded conditions using calibrated RocTest vane shear equipment. The sensitivity shown on the boring logs is the ratio of shear strength in undisturbed and remolded conditions. In general, the vane shear values for soft clays were significantly higher than the corresponding values from unconfined compressive strength tests using the RIMAC apparatus. Vane shear test results were used for analyses.

3.3 Laboratory Testing

The soil samples were tested in the laboratory for moisture content (AASHTO T265). Atterberg limits (AASHTO T 89/T 90) and particle size analyses (AASHTO T 88) tests were performed on selected soil samples representing the main soil layers encountered during the investigation. Field visual descriptions of the soil samples were verified in the laboratory. Laboratory test results are shown in the *Boring Logs* (Appendix A), in the *Soil Profile* (Exhibit 4), and in the *Laboratory Test Results* (Appendix B).

4.0 RESULTS OF FIELD AND LABORATORY INVESTIGATIONS

Detailed descriptions of the soil conditions encountered during our subsurface investigation are presented in the attached *Boring Logs* (Appendix A) and in the *Soil Profile* (Exhibit 4). Please note that strata contact lines represent approximate boundaries between soil types. The actual transition between soil types in the field may be gradual in horizontal and vertical directions.

4.1 Soil Conditions

Borings drilled on the roadway encountered 2 to 3 inches of asphalt overlying 8 to 15 inches of concrete followed by crushed stone base course. Borings drilled on the grassy area encountered 4 inches of silty loam topsoil. In descending order, the general lithologic succession encountered

beneath the pavement structure or topsoil includes: 1) man-made ground (fill); 2) medium stiff to very stiff silty clay loam; 3) very soft to medium stiff clay to silty clay; 4) stiff to hard clay to silty clay loam and silty loam; 5) hard silty clay loam and dense to very dense silt to silty loam and gravelly sand; and 6) strong dolostone.

1) Man-made ground (fill)

Underneath the topsoil or pavement structure, the borings encountered 2 to 5 feet of fill materials. Granular fill consists of loose to dense, gray crushed stone to brown sandy gravel and dark brown silty loam. Cohesive fill includes very stiff to hard, gray to black silty clay to silty clay loam. The granular fill layer has N-values of 7 to 45 blows per foot and moisture content values of 7 to 16%. The cohesive fill layer has unconfined compressive strength (Q_u) values of 3.4 to greater than 4.5 tsf and moisture content values of 12 to 17%.

2) Medium stiff to stiff silty clay loam

Beneath the fill, at elevations of 573 to 583 feet, the borings encountered 3 to 5-foot thick of medium stiff to stiff, brown to gray silty clay loam. This layer has Q_u values ranging from 0.9 to 2.0 tsf and moisture content values of 17 to 23%. This layer is commonly known as the “crust.”

3) Very soft to medium stiff clay to silty clay

At elevations of 568 to 583 feet (5 to 8 feet bgs), the borings revealed up to 41 feet of very soft to medium stiff, gray clay to silty clay with Rimac Q_u values of 0.03 to 1.15 tsf and moisture content values of 16 to 29%. Laboratory index testing on samples from this layer showed liquid limit (L_L) values of 31 to 37% and plastic limit (P_L) values of 17 to 19%. This layer is commonly known as the “Chicago Blue Clay.”

As discussed in Section 3.2, undrained shear strength values from vane shear tests are generally higher than Rimac tests. In-situ undisturbed vane shear strengths obtained in Borings VST-01, 1729-VST-01, and 1729-VST-02 between elevations 575 and 542 feet varied from 580 to 1510 psf.

4) Stiff to hard clay to silty clay loam and silty loam

At elevations of 539 to 544 feet (37 to 42 feet bgs), the borings encountered up to 20 feet of stiff to hard clay to silty clay loam. The clay to silty clay has Q_u values of 1.5 to 7.8 tsf and moisture content values of 14 to 30%. The borings encountered 3 to 10 feet of medium dense silt to silty loam layers with N values of 9 to 32 blows per foot.

(5) Hard silty clay loam and very dense silt to silty loam and gravelly sand

At elevations of 521 to 524 feet (49 to 59 feet bgs) the borings encountered up to 30 feet of hard silty clay loam to silty loam, dense to very dense silt to silty loam and very dense gravelly sand. This layer has Q_u values of 4.5 to 10.3 tsf, moisture content values of 11 to 18%, and N values of 6 to over 50 blows per foot. Numerous sampler refusal and hard drilling conditions were recorded within this layer.

(6) Strong dolostone

The nearby structure borings, 1087-B-02, 1087-B-02Alt, and 1712-B-01 encountered strong bedrock at elevations of 488.8 to 490.5 feet or 87 to 89 feet bgs. Based on the 10-foot rock core obtained from the borings, the measured RQD values are 84 to 89% corresponding good rock quality. *Bedrock core photographs* are shown in Appendix A.

4.2 Groundwater Conditions

Groundwater was observed during drilling at elevations of 570 to 574 feet (3.5 bgs) within the granular fill layer. The groundwater was not observed during drilling or after drilling in borings due to the mud rotary drilling from 10 to 20 feet bgs. A Piezometer 1703-PZ-01 was installed for the nearby structure about 630 feet northeast of the proposed retaining Wall 18 on November 12, 2014. The screen was placed with the top and bottom elevations at 507.2 and 487.2 feet (75 to 95 feet bgs), respectively within granular layer deposit above bedrock. A summary of the monitoring data between November 2014 and March 2017 is shown in Figure 1.

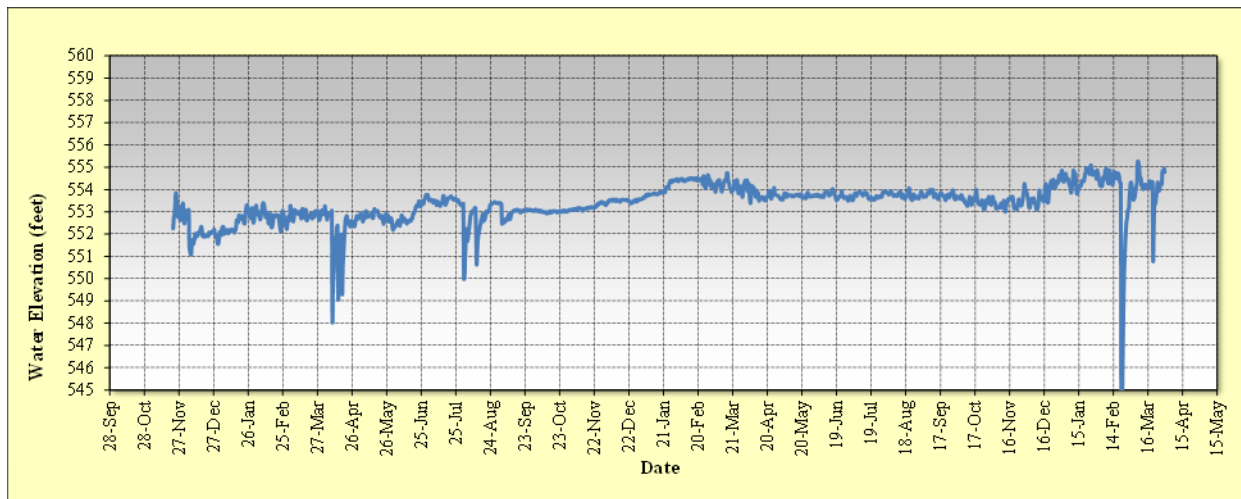

Figure 1: Summary of Groundwater Monitoring Data

The data shows groundwater that is under hydrostatic pressure head. The average hydrostatic elevation within the aquifer is about 553 feet. However, the hydrostatic pressure will not impact the proposed Wall 18 construction since the MSE wall is proposed at much higher elevations.

The design and construction of the wall should consider the perched water between 570 and 576 feet elevations within the fill layers with permanent groundwater elevation for 553.

4.3 Seismic Design Considerations

The retaining wall is located in Seismic Performance Zone (SPZ) 1 and is not required to be designed for seismic forces as per 2012 IDOT *Bridge Manual* (IDOT 2012).

5.0 ANALYSIS AND RECOMMENDATIONS

5.1 Retaining Wall Type Evaluation

Based on the TSL plan, the proposed Retaining Wall 18 is a fill wall supporting the west approach of the Ramp EN Bridge. The MSE walls will have a maximum retained height of approximately 12.4 feet. The maximum wall height measured from the top of levelling pad to the top of coping/finished grade at B.F. of wall will be 15.9 feet. Based on the MSE wall layout, the MSE wall was analyzed for the two distinct sections; one for back-to-back portion of the MSE wall between Stations 1607+00.00 and 1608+00.47 and the second section as the extended portion of the South MSE wall between Stations 1605+00.00 and 1607+00.00.

Consideration was given in using standard cast-in-place concrete cantilever (T-type) with spread footings; however, it was ruled out due to low bearing resistance and excessive settlements of foundation soils. They would need to be supported on driven piles or drilled shafts. Driven piles are not considered suitable due to noise and vibration concerns but drilled shafts placed on hardpan could be used. The proposed MSE wall is a feasible option but will require IDOT District One Class III LCCF to satisfy the maximum 1-inch settlement criterion for the roadway.

The following sections present the results of our geotechnical engineering analyses and recommendations for the MSE wall design and construction.

5.2 Back-to-Back MSE Wall Section

The MSE retaining wall base should be established a minimum of 3.5 feet below the finished grade at the front face of the wall for frost protection. The proposed MSE walls on the north and south sides are back-to-back fill walls between Stations 1607+00.00 and 1608+00.47.

5.2.1 Bearing Resistance and External Stability Analyses

Based on our boring data, the foundation soils at the MSE wall base elevations includes about 3 feet of very stiff silty clay loam overlying up to 36 feet of soft to medium stiff clay to silty clay. We estimate the foundation soils will have a nominal bearing resistance of 3,300 psf and a factored bearing resistance of 2,100 psf based on a geotechnical resistance factor of 0.65 (AASHTO 2014).

We analyzed the following options to satisfy the factored bearing resistance available, external stability, and settlement. A reinforcement length equal to 70 percent of the total wall height or a minimum of 8 feet was used.

1. Using regular fill material (unit weight of 125 pcf) for the MSE wall zone and fill area; and
2. Using IDOT District One Class III Lightweight Cellular Concrete Fill (LCCF) for the MSE reinforcement zone between the back-to back walls.

For Option 1, at the highest portion of the wall will apply a maximum factored equivalent bearing pressure of 4,500 psf with a regular MSE wall fill material (unit weight is 125 pcf) which exceeds the factored bearing resistance available. Thus, Option 1 is not feasible.

In Option 2, to reduce the applied wall pressure, we have considered IDOT District One Class III LCCF for the MSE wall zone and the fill area in the back-to-back walls between Stations 1607+00.00 and 1608+00.47. There are no lateral forces pushing the wall; therefore, eccentricity is not a concern. We estimate the wall and fill area between back-to-back walls will apply a maximum equivalent factored bearing pressure of 1,700 psf, thus the foundation soils will have sufficient bearing resistance to support the wall. This option is recommended.

The estimated friction angle between an MSE wall base and underlying cohesive soil is 30° , and the corresponding friction coefficient is 0.58. MSE retaining walls are designed based on a geotechnical sliding resistance factor of 1.0 for soil-on-soil contact (AASHTO 2014).

5.2.2 Settlement Analyses

We performed settlement analyses using data from Borings 1729-VST-01 and 18-RWB-01 since they are more conservative and closest to maximum height of the wall near Station 1607+90. We estimate the wall with Class III LCCF fill material will apply a maximum service pressure of 770 psf. We calculated the corresponding long-term settlement of cohesive foundation soils using IDOT *Spreadsheet for Cohesive Soils* dated December 9, 2014.

Our settlement analyses indicate the wall will undergo maximum 1.0 inch of long-term settlement from the underlying cohesive soils. The estimated settlement is appropriate for the construction of the MSE wall and roadway.

5.2.3 Global Stability Analyses

With Class III LCCF being used as a fill material in reinforced zone and in between the walls, the whole mass will act as rigid body with significant reduction of the driving forces, thus, we do not see global instability concerns for the proposed back-to-back MSE retaining walls.

5.3 Extended South MSE Wall Section

Based on the *In-Progress Cross-section* drawings (Appendix E), the extended south MSE Wall section between Station 1605+00 and 1607+00 is a hybrid cut and fill wall to retain the proposed Ramp EN embankment and the proposed Ramp ES backslope. The total wall height gradually increases from 3.5 to 14.3 feet. The MSE retaining wall base should be established a minimum of 3.5 feet below the finished grade at the front face of the wall for frost protection. Based on the Cross-

Section drawings, we note that open cut excavations or temporary soil retention system will be required for the portion to construct the MSE wall.

5.3.1 Bearing Resistance and External Stability Analyses

Based on our boring data, the foundation soils at the MSE wall base elevations includes about 5 feet of medium stiff silty clay overlying up to 40 feet of soft to medium stiff clay to silty clay. We estimate the foundation soils will have a nominal bearing resistance of 3,100 psf and a factored bearing resistance of 2,000 psf based on a geotechnical resistance factor of 0.65 (AASHTO 2014).

We analyzed the following options to satisfy the factored bearing resistance available and external stability. We have considered reinforcement lengths equal to 70 percent of the total wall height (maximum 15.9 feet) or a minimum of 8 feet. We have analyzed several alternatives for the fill material to be used in the reinforcement zone and fill area on top of 1:1.5 (V:H) excavation back-slope, as follows:

1. Using regular fill material (unit weight of 125 pcf) for the MSE wall zone fill area;
2. Using IDOT District One Class III LCCF for the MSE reinforcement zone and on top of laid back excavation back-slope.

For Option 1, at the highest portion of the wall near Station 1607+00, the wall will apply a maximum factored equivalent bearing pressure of 4,200 psf for 0.7 H reinforcement length and 3,200 psf for 1.2 H reinforcement length with a regular MSE wall fill material (unit weight is 125 pcf) which exceeds the factored bearing resistance available. Thus, the Option 1 is not feasible.

For Option 2, we have considered Class III LCCF for MSE wall reinforcement zone and on top of laid back excavation back-slope, thus no lateral push was considered. We estimate the wall will apply a maximum factored equivalent bearing pressure of 1,700 psf, thus the foundation soils will have sufficient bearing resistance to support the wall.

To minimize the excavation behind the wall between Stations 1605+00.00 and 1607+00.00, we recommend Option 2 with 0.7 H reinforcement width. It should be noted that the normal weight portion of the overall embankment behind the wall system be laid back so it does not exert any earth pressure on the LCCF backfill that is to be placed behind the LCCF MSE Mass.

The estimated friction angle between an MSE wall base and underlying cohesive soil is 30°, and the corresponding friction coefficient is 0.58. MSE retaining walls are designed based on a geotechnical sliding resistance factor of 1.0 for soil-on-soil contact (AASHTO 2014).

5.3.2 Settlement Analyses

Considering the placement of LCCF on MSE Wall zone area and back-slope, the estimated long-term settlement will be 1 inch or less.

5.3.3 Global Stability Analyses

Global stability analysis was performed for the MSE wall maximum section with total height of 15.9 feet for both short-term (undrained) and long-term (drained). We estimate the maximum wall section has a short-term factor of safety (FOS) of 2.0 and a long-term FOS of 2.3 (Appendices C-1 and C-2), therefore satisfying the minimum IDOT FOS requirements (IDOT, 2015). The undrained analysis for temporarily excavated ground sloped at 1:1.5 (V:H) before construction of MSE wall showed FOS of 1.9 (Appendix C-3).

6.0 CONSTRUCTION CONSIDERATIONS

6.1 Excavation

Any required excavations should be performed in accordance with local, state, and federal regulations including current OSHA regulations. The potential effect of ground movements upon nearby structures and utilities should be considered during construction. The extended portion of south wall will require temporary open cut excavations that could have maximum back-slope of 1:1.5 (V:H), depending on actual ground conditions encountered during construction.

6.2 Dewatering

Based on the results of our investigation and proposed excavation for the wall, perched water is likely to be encountered during construction during times of heavy precipitation which should be removed through conventional sump and pump methods.

6.3 Filling and Backfilling

All fill and backfill materials will be as per IDOT Standard Specification.

6.4 MSE Wall Construction

The MSE wall should be constructed as per Section 522 Retaining Walls of the IDOT Standard Specifications. Select fill material should be Class III LCCF material as per IDOT District One Special Provisions. The impact of the presence of existing buildings, parking lots, and utilities on the construction of the proposed Wall 18 should be evaluated.

6.5 Construction Monitoring

There is no need for special construction monitoring for the retaining wall except normally required by the IDOT *Standard Specification for Road and Bridge Construction* (IDOT 2016).

7.0 QUALIFICATIONS

The analysis and recommendations submitted in this report are based upon the data obtained from the borings drilled at the locations shown on the boring logs and in Exhibit 3. This report does not reflect any variations that may occur between the borings or elsewhere on the site, variations whose nature and extent may not become evident until the course of construction. In the event that any changes in the design and/or location of Retaining Wall 18 (SN016-1807) are planned, we should be timely informed so that our recommendations can be adjusted accordingly.

It has been a pleasure to assist AECOM and the Illinois Department of Transportation on this project. Please call if there are any questions, or if we can be of further service.

Respectfully Submitted,

WANG ENGINEERING, INC.



Metin W. Seyhun, P.E.
Senior Geotechnical Engineer

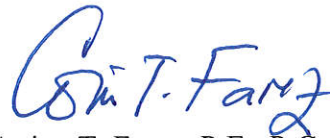

Corina T. Farez, P.E., P.G.
Vice President

REFERENCES

- AMERICAN ASSOCIATION OF STATE HIGHWAY TRANSPORTATION OFFICIALS (2014) *LRFD Bridge Design Specifications*. United States Department of Transportation, Washington, D.C.
- BAUER, R.A., CURRY, B.B., GRAESE, A.M., VAIDEN, R.C., SU, W.J., and HASEK, M.J., 1991, *Geotechnical Properties of Selected Pleistocene, Silurian, and Ordovician Deposits of Northeastern Illinois*: Environmental Geology 139, Illinois State Geological Survey, 69 p.
- HANSEL, A.K., and JOHNSON, W.H. (1996) *Wedron and Mason Groups: Lithostratigraphic Reclassification of the Wisconsin Episode, Lake Michigan Lobe Area: ISGS Bulletin 104*. Illinois State Geological Survey, Champaign, IL. 116 p.
- LEETARU, H.E., SARGENT, M.L., AND KOLATA, D.R., 2004, *Geologic Atlas of Cook County for Planning Purposes*, ISGS, Champaign, IL
- ILLINOIS DEPARTMENT OF TRANSPORTATION (2015) *Geotechnical Manual*. IDOT Bureau of Materials and Physical Research, Springfield, IL.
- ILLINOIS DEPARTMENT OF TRANSPORTATION (2016) *Standard Specifications for Road and Bridge Construction*. IDOT Division of Highways, Springfield, IL.
- ILLINOIS DEPARTMENT OF TRANSPORTATION (2012) *Bridge Manual*. IDOT Bureau of Bridges and Structures, Springfield, IL.
- WILLMAN, H.B., 1971, *Summary of the Geology of the Chicago Area*, ISGS Circular C460: Urbana, Illinois State Geological Survey, p. 77.
- PECK, R.B., and REED, W.C., 1954, *Engineering Properties of Chicago Subsoils*: University of Illinois Engineering Experiment Station Bulletin No. 423: Urbana, University of Illinois, 62 p.

EXHIBITS

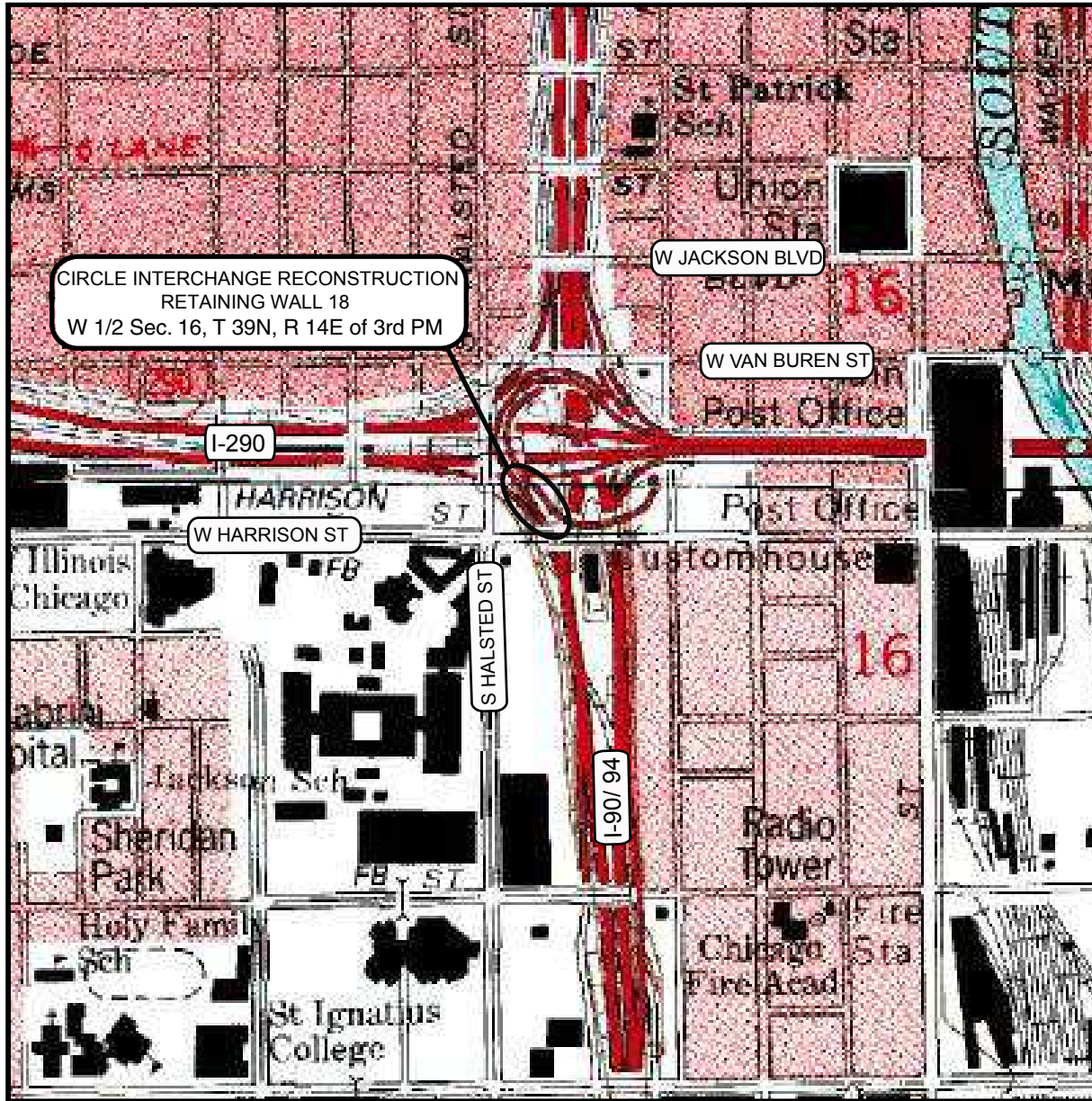

Cook County

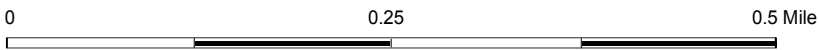

SITE LOCATION MAP: CIRCLE INTERCHANGE RECONSTRUCTION, RETAINING WALL 18, SN 016-1807, CHICAGO, IL

SCALE: GRAPHICAL

EXHIBIT 1

DRAWN BY: RKC
CHECKED BY: NSB



1145 N. Main Street
Lombard, IL 60148
www.wangeng.com

FOR AECOM

1100-04-01

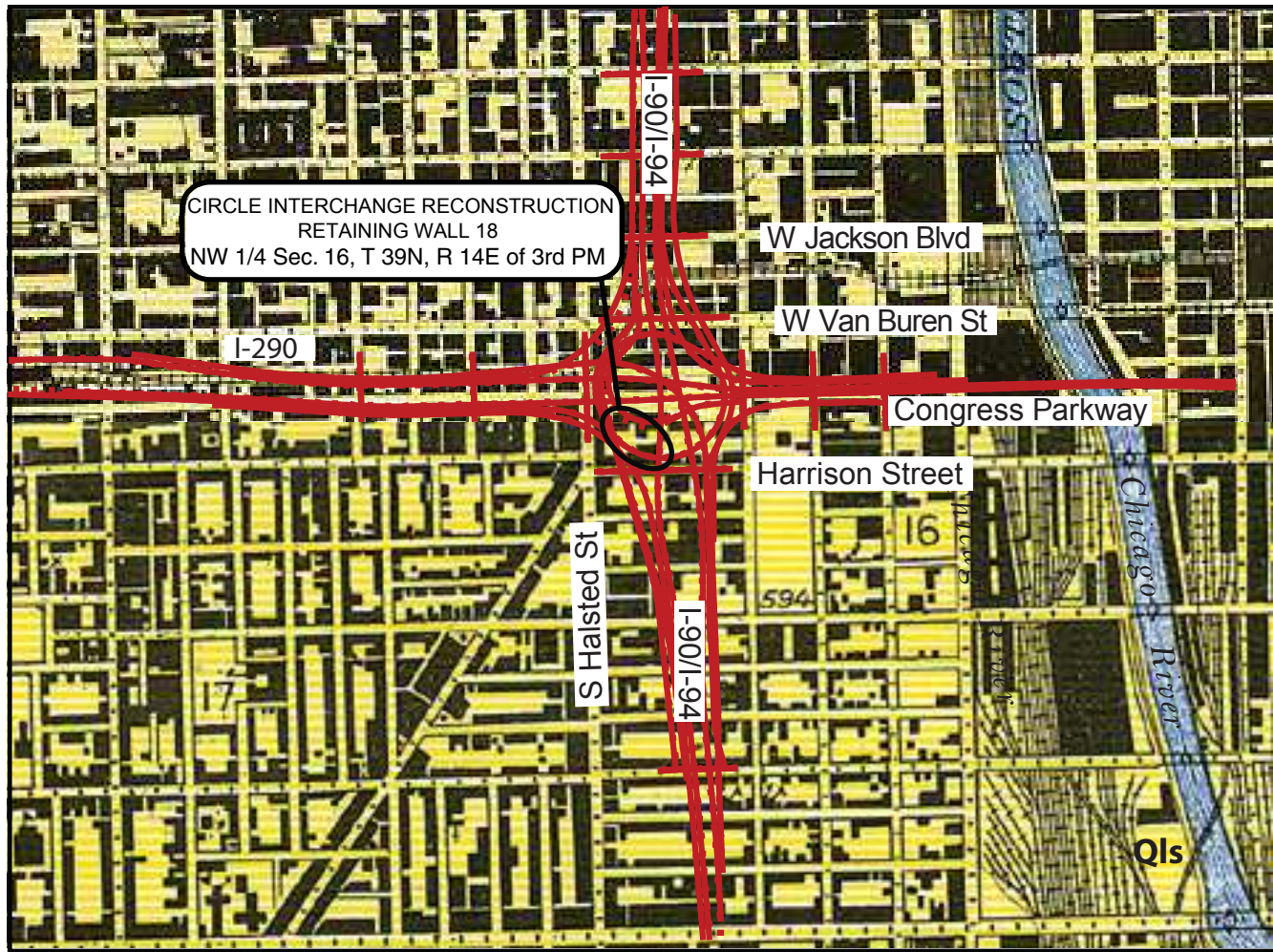

REGIONAL GEOLOGY

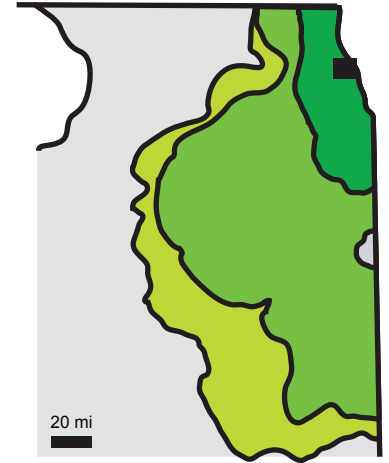

Wedron Group

- Wadsworth Formation
- Lemont Formation
- Tiskilwa Formation

Modified after Hansel and Johnson (1996)

Legend

- Qls
Glacial lake bottom
(Covered by lacustrine deposits)

0 0.5 1.0 Miles

Modified after Bretz (1926)

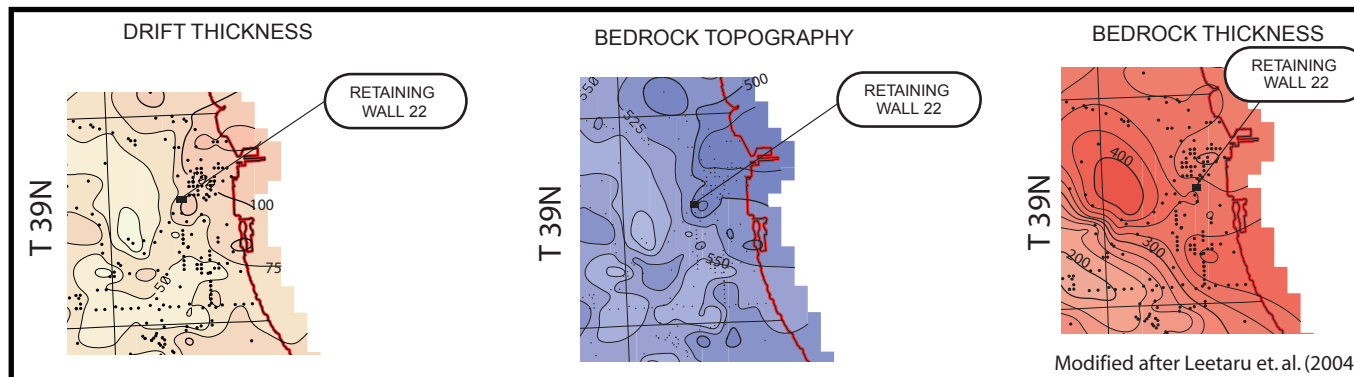

0 2 4 8 miles

Modified after Leetaru et. al. (2004)

SITE AND REGIONAL GEOLOGY: CIRCLE INTERCHANGE RECONSTRUCTION, RETAINING WALL 18, SN 016-1807, CHICAGO, IL

SCALE: GRAPHICAL

EXHIBIT 2

DRAWN BY: RKC
CHECKED BY: NSB



1145 N. Main Street
Lombard, IL 60148
www.wangeng.com

FOR AECOM

1100-04-01

Benchmark: Cut square on center of door entrance to 707 W. Harrison St. (south side of Harrison St., approx. 90' west of west line of Des Plaines St.). Elevation 597.47.

Existing Structure: None

DESIGN SPECIFICATIONS

2014 AASHTO LRFD Bridge Design Specifications, 7th Edition with 2015 and 2016 Interim Revisions

DESIGN STRESSES

FIELD UNITS

f'c = 3,500 psi (Cast-in-place)
fy = 60,000 psi (Reinforcement)

PRECAST UNITS

f'c = 4,500 psi (Precast Panels)
fy = 60,000 psi (Reinforcement)

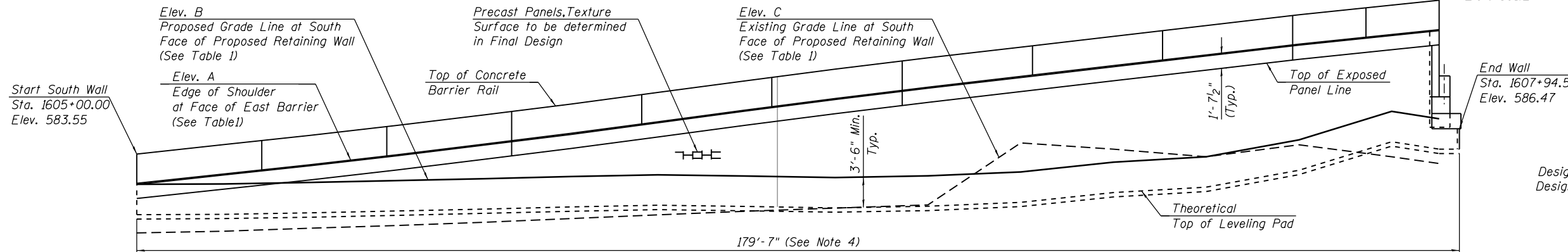

SOUTH ELEVATION

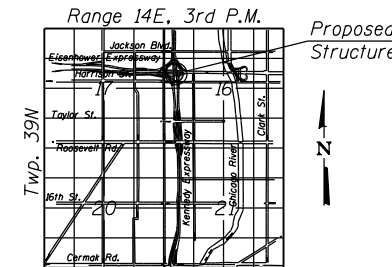

LOCATION SKETCH

SEISMIC DATA

Seismic Performance Zone (SPZ) = 1
Design Spectral Acceleration at 1.0 sec. (SD1) = 0.085g
Design Spectral Acceleration at 0.2 sec. (SDS) = 0.144g
Soil Site Class = D

LEGEND:

- Soil Boring
- Exist. Catch Basin
- Exist. Underground Electric
- Exist. Storm Sewer
- Prop. Storm Sewer
- Exist. Telephone

*NOTE: Boring Out Of Plan

- 1729-VST-01, 1897455.092N, 1171356.398E
- 1729-VST-02, 1897206.551N, 1171441.786E
- VST-01, 1897108.355N, 1171435.633E

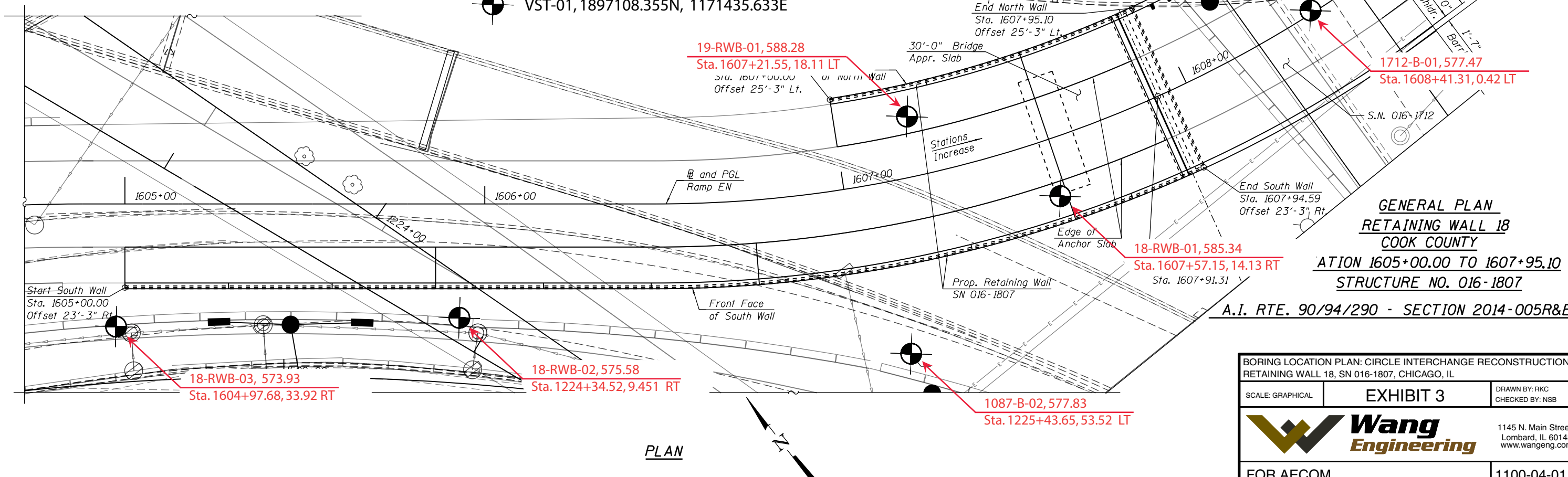

**GENERAL PLAN
RETAINING WALL 18
COOK COUNTY**

**ATION 1605+00.00 TO 1607+95.10
STRUCTURE NO. 016-1807**

A.I. RTE. 90/94/290 - SECTION 2014-005R&B

BORING LOCATION PLAN: CIRCLE INTERCHANGE RECONSTRUCTION, RETAINING WALL 18, SN 016-1807, CHICAGO, IL

SCALE: GRAPHICAL **EXHIBIT 3** DRAWN BY: RKC CHECKED BY: NSB

Wang Engineering 1145 N. Main Street Lombard, IL 60148 www.wangeng.com

FOR AECOM 1100-04-01

PLAN

**STATE OF ILLINOIS
DEPARTMENT OF TRANSPORTATION**

STRUCTURE NO. 016-1807

SCALE: _____ SHEET _____ OF 3 SHEETS STA. _____ TO STA. _____

FILE PATH = p:\617479-PMINT\recon\line\local\BDCM_D902_MIA\Documents\01_Americas\T\engor\station\60269938_Circle\Phase_1\000_CAD\008_Structural\RetainingWall_18_Sheets\0161807-6079-501-TSL-001

HBM ENGINEERING GROUP, LLC CONSULTING & DESIGN INSPECTION & RATING RESEARCH & TESTING	4415 WEST HARRISON ST. SUITE 231 MILLSIDE, IL 60162 PHONE: (708) 236-0900 FAX: (708) 236-0901	USER NAME = Ken.drabant	DESIGNED - _____	REVISED - _____
		PLOT SCALE = 28.00' / in.	DRAWN - _____	REVISED - _____
		PLOT DATE = 8/31/2017	CHECKED - _____	REVISED - _____
			DATE - 08/11/2017	REVISED - _____

F.A.I. RTE.	SECTION	COUNTY	TOTAL SHEETS	SHEET NO.
90/94/290	2014-005R&B	COOK	3	_____
CONTRACT NO. 60X79			ILLINOIS FED. AID PROJECT	

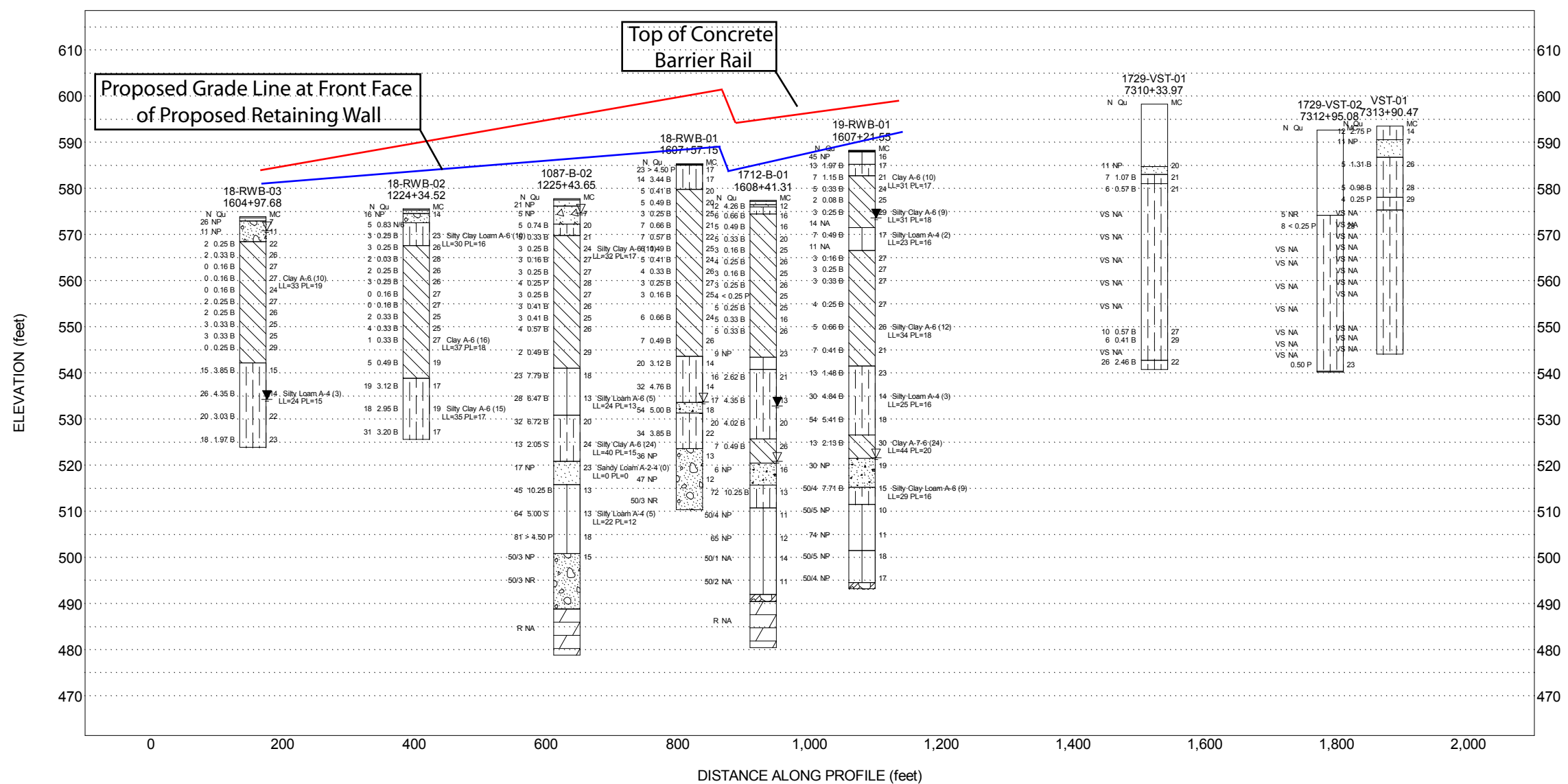
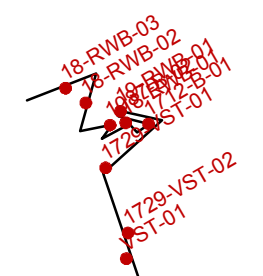
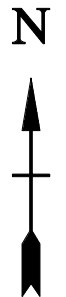

Lithology Graphics

- | | | | |
|---------------------------------|----------------------|----------------------|---------------------------------|
| Pavement | Concrete | Crushed stone | IDH Silty Clay, Silty Clay Loam |
| IDH Clay | IDH Silt, Silty Loam | IDH Sand, Sandy Loam | Gravelly sand, sandy gravel |
| Dolomite or Dolomitic Limestone | Coarse sand | Weathered bedrock | Topsoil |

Site Map Scale 1 inch equals 735 feet

Explanation:

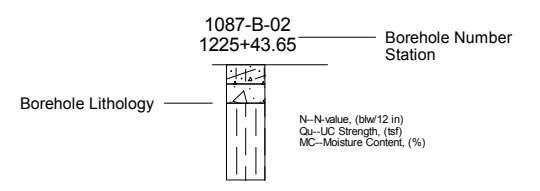

- Water Level Reading at time of drilling.
- Water Level Reading 24-hr after drilling or at end of drilling.

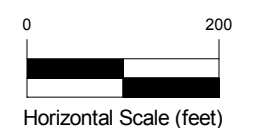

Vertical Exaggeration: 7x

Wang Engineering, Inc.
1145 N Main Street
Lombard, IL 60148

**Subsurface Soil Data Profile
Retaining Wall 18, SN 016-1807**



Circle Interchange Reconstruction
Section 17, T39N, R14E of 3rd PM

JOB NUMBER	PLATE NUMBER
1100-04-01	EXHIBIT 4

APPENDIX A



wangeng@wangeng.com
 1145 N Main Street
 Lombard, IL 60148
 Telephone: 630 953-9928
 Fax: 630 953-9938

BORING LOG 18-RWB-01

WEI Job No.: 1100-04-01

Client: **AECOM**
 Project: **Circle Interchange Reconstruction**
 Location: **Section 17, T39N, R14E of 3rd PM**

Datum: NAVD 88
 Elevation: 585.35 ft
 North: 1897627.64 ft
 East: 1171433.33 ft
 Station: 1607+57.15
 Offset: 14.1384 RT

Profile	Elevation (ft)	SOIL AND ROCK DESCRIPTION	Depth (ft)	Sample Type recovery	Sample No.	SPT Values (blw/6 in)	Qu (tsf)	Moisture Content (%)	Profile	Elevation (ft)	SOIL AND ROCK DESCRIPTION	Depth (ft)	Sample Type recovery	Sample No.	SPT Values (blw/6 in)	Qu (tsf)	Moisture Content (%)
	585.04	1/2-inch thick, black SILTY LOAM --TOPSOIL-- Very stiff to hard, brown and gray SILTY CLAY LOAM, trace gravel --FILL--			1	13 11 12	4.50 P	17									
			5		2	6 6 8	3.44 B	17				25		9	1 2 3	0.41 B	24
	579.8	Very soft to medium stiff, gray CLAY to SILTY CLAY, trace gravel			3	2 2 3	0.41 B	20						10	1 2 2	0.33 B	26
			10		4	2 2 3	0.49 B	20				30		11	1 1 2	0.25 B	27
					5	0 1 2	0.25 B	25						12	1 1 2	0.16 B	25
			15		6	2 3 4	0.66 B	21				35		13	2 2 4	0.66 B	24
					7	2 3 4	0.57 B	22									
			20		8	1 3 3	0.49 B	25				40		14	2 3 4	0.49 B	26

GENERAL NOTES

Begin Drilling **10-16-2013** Complete Drilling **10-17-2013**
 Drilling Contractor **Wang Testing Services** Drill Rig **D-25 ATV [93%]**
 Driller **P&N** Logger **F. Bozga** Checked by **C. Marin**
 Drilling Method **2.25" HSA to 10', mud rotary thereafter, boring**
backfilled upon completion

WATER LEVEL DATA

While Drilling ∇ **52.00 ft**
 At Completion of Drilling ∇ **mud in the borehole**
 Time After Drilling **NA**
 Depth to Water ∇ **NA**

The stratification lines represent the approximate boundary between soil types; the actual transition may be gradual.

WANGENGINC 11000401.GPJ WANGENG.GDT 9/20/17



wangeng@wangeng.com
 1145 N Main Street
 Lombard, IL 60148
 Telephone: 630 953-9928
 Fax: 630 953-9938

BORING LOG 18-RWB-01

WEI Job No.: 1100-04-01

Client: **AECOM**
 Project: **Circle Interchange Reconstruction**
 Location: **Section 17, T39N, R14E of 3rd PM**

Datum: NAVD 88
 Elevation: 585.35 ft
 North: 1897627.64 ft
 East: 1171433.33 ft
 Station: 1607+57.15
 Offset: 14.1384 RT

Profile	Elevation (ft)	SOIL AND ROCK DESCRIPTION	Depth (ft)	Sample Type recovery	Sample No.	SPT Values (blw/6 in)	Qu (tsf)	Moisture Content (%)	Profile	Elevation (ft)	SOIL AND ROCK DESCRIPTION	Depth (ft)	Sample Type recovery	Sample No.	SPT Values (blw/6 in)	Qu (tsf)	Moisture Content (%)
	543.6	Very stiff to hard, gray SILTY CLAY LOAM, trace gravel								523.6	Dense to very dense, gray GRAVELLY SAND --Wet--						
			45	X	15	5 6 14	3.12 B	14				65	X	19	17 19 17	NP	13
			50	X	16	9 14 18	4.76 B	14				70	X	20	26 26 21	NP	12
	533.6	Gray, medium to coarse SAND, trace gravel --Wet--									--HARD DRILLING-- --Possible Cobbles--						
	531.3	Very stiff to hard, gray SILTY CLAY, trace gravel								510.3	Boring terminated at 75.00 ft						
			55	X	17	13 22 32	5.00 B	18				75	○	21	22 50/3	NR	
			60	X	18	11 11 23	3.85 B	22				80					

GENERAL NOTES

WATER LEVEL DATA

Begin Drilling **10-16-2013** Complete Drilling **10-17-2013**
 Drilling Contractor **Wang Testing Services** Drill Rig **D-25 ATV [93%]**
 Driller **P&N** Logger **F. Bozga** Checked by **C. Marin**
 Drilling Method **2.25" HSA to 10', mud rotary thereafter, boring backfilled upon completion**

While Drilling ▽ **52.00 ft**
 At Completion of Drilling ▼ **mud in the borehole**
 Time After Drilling **NA**
 Depth to Water ▼ **NA**
 The stratification lines represent the approximate boundary between soil types; the actual transition may be gradual.

WANGENGINC 11000401.GPJ WANGENG.GDT 9/20/17



wangeng@wangeng.com
 1145 N Main Street
 Lombard, IL 60148
 Telephone: 630 953-9928
 Fax: 630 953-9938

BORING LOG 18-RWB-02

WEI Job No.: 1100-04-01

Client: **AECOM**
 Project: **Circle Interchange Reconstruction**
 Location: **Section 17, T39N, R14E of 3rd PM**

Datum: NAVD 88
 Elevation: 575.58 ft
 North: 1897703.15 ft
 East: 1171280.67 ft
 Station: 1224+34.52
 Offset: 9.451 RT

Profile	Elevation (ft)	SOIL AND ROCK DESCRIPTION	Depth (ft)	Sample Type recovery	Sample No.	SPT Values (blw/6 in)	Qu (tsf)	Moisture Content (%)	Profile	Elevation (ft)	SOIL AND ROCK DESCRIPTION	Depth (ft)	Sample Type recovery	Sample No.	SPT Values (blw/6 in)	Qu (tsf)	Moisture Content (%)
	575.3	3-inch thick ASPHALT --PAVEMENT--															
	574.6	9-inch thick CONCRETE --PAVEMENT--															
	572.6	Medium dense, brown SANDY GRAVEL --FILL--			1	11 10 6	NP	14						9	0 0 0	0.16 B	27
		Soft to medium stiff, gray SILTY CLAY LOAM, trace gravel			2	2 2 3	0.83 N/6					25		10	0 0 2	0.33 B	25
		--L _L (%)=30, P _L (%)=14-- --%Gravel=3.5-- --%Sand=15.1-- --%Silt=56.3-- --%Clay=25.2-- --A-6 (10)--			3	1 1 2	0.25 B	23						11	0 2 2	0.33 B	25
	567.6	Very soft to medium stiff, gray CLAY to SILTY CLAY, trace gravel			4	1 1 2	0.25 B	26						12	0 0 1	0.33 B	27
					5	0 0 2	0.03 B	28									
					6	0 1 1	0.25 B	26						13	1 2 3	0.49 B	19
					7	0 1 2	0.25 B	26		538.8	Very stiff, gray SILTY CLAY, trace gravel						
					8	0 0 0	0.16 B	27						14	4 9 10	3.12 B	17

GENERAL NOTES

Begin Drilling **10-14-2013** Complete Drilling **10-14-2013**
 Drilling Contractor **Wang Testing Services** Drill Rig **D-50 TMR [78%]**
 Driller **R&N** Logger **D. Kolpacki** Checked by **C. Marin**
 Drilling Method **3.25" HSA, boring backfilled upon completion**

WATER LEVEL DATA

While Drilling **Rotary wash**
 At Completion of Drilling **mud in the borehole**
 Time After Drilling **NA**
 Depth to Water **NA**

The stratification lines represent the approximate boundary between soil types; the actual transition may be gradual.

WANGENGINC 11000401.GPJ WANGENG.GDT 9/20/17



BORING LOG 18-RWB-02

wangeng@wangeng.com
 1145 N Main Street
 Lombard, IL 60148
 Telephone: 630 953-9928
 Fax: 630 953-9938

WEI Job No.: 1100-04-01

Client: **AECOM**
 Project: **Circle Interchange Reconstruction**
 Location: **Section 17, T39N, R14E of 3rd PM**

Datum: NAVD 88
 Elevation: 575.58 ft
 North: 1897703.15 ft
 East: 1171280.67 ft
 Station: 1224+34.52
 Offset: 9.451 RT

Profile	Elevation (ft)	SOIL AND ROCK DESCRIPTION	Depth (ft)	Sample Type recovery	Sample No.	SPT Values (blw/6 in)	Qu (tsf)	Moisture Content (%)	Profile	Elevation (ft)	SOIL AND ROCK DESCRIPTION	Depth (ft)	Sample Type recovery	Sample No.	SPT Values (blw/6 in)	Qu (tsf)	Moisture Content (%)
	525.6		45		15	4 8 10	2.95 B	19									
		--L _L (%)=35, P _L (%)=17-- --%Gravel=2.2-- --%Sand=9.4-- --%Silt=51.7-- --%Clay=36.7-- --A-6 (15)-															
			50		16	6 17 14	3.20 B	17									
		Boring terminated at 50.00 ft															

GENERAL NOTES

WATER LEVEL DATA

Begin Drilling **10-14-2013** Complete Drilling **10-14-2013**
 Drilling Contractor **Wang Testing Services** Drill Rig **D-50 TMR [78%]**
 Driller **R&N** Logger **D. Kolpacki** Checked by **C. Marin**
 Drilling Method **3.25" HSA, boring backfilled upon completion**

While Drilling **Rotary wash**
 At Completion of Drilling **mud in the borehole**
 Time After Drilling **NA**
 Depth to Water **NA**

The stratification lines represent the approximate boundary between soil types; the actual transition may be gradual.



BORING LOG 18-RWB-03

wangeng@wangeng.com
 1145 N Main Street
 Lombard, IL 60148
 Telephone: 630 953-9928
 Fax: 630 953-9938

WEI Job No.: 1100-04-01

Client **AECOM**
 Project **Circle Interchange Reconstruction**
 Location **Section 17, T39N, R14E of 3rd PM**

Datum: NAVD 88
 Elevation: 573.93 ft
 North: 1897759.34 ft
 East: 1171203.61 ft
 Station: 1604+97.68
 Offset: 33.9208 RT

Profile	Elevation (ft)	SOIL AND ROCK DESCRIPTION	Depth (ft)	Sample Type recovery	Sample No.	SPT Values (blw/6 in)	Qu (tsf)	Moisture Content (%)	Profile	Elevation (ft)	SOIL AND ROCK DESCRIPTION	Depth (ft)	Sample Type recovery	Sample No.	SPT Values (blw/6 in)	Qu (tsf)	Moisture Content (%)
	573.64	1/4-inch thick ASPHALT --PAVEMENT--															
	572.9	8-inch thick CONCRETE --PAVEMENT--															
		Medium dense, brown SANDY GRAVEL and CRUSHED STONE --FILL--			1	12 14 12	NP	7						9	0 0 2	0.25 B	26
					2	4 5 6	NP	11				25		10	0 1 2	0.33 B	25
	568.4	Very soft to soft, gray CLAY to SILTY CLAY, trace gravel			3	2 1 1	0.25 B	22						11	0 1 2	0.33 B	25
					4	0 1 1	0.33 B	26						12	0 0 0	0.25 B	29
					5	0 0 0	0.16 B	27		542.2	Stiff to hard, gray SILTY CLAY LOAM to SILTY LOAM, trace gravel						
		--L _L (%)=33, P _L (%)=19-- --%Gravel=2.2-- --%Sand=9.4-- --%Silt=51.7-- --%Clay=36.7-- --A-6 (10)--			6	0 0 0	0.16 B	27						13	3 5 10	3.85 B	15
					7	0 0 0	0.16 B	24									
					8	0 1 1	0.25 B	27			--L _L (%)=24, P _L (%)=15-- --%Gravel=8.4-- --%Sand=24.5--			14	8 12 14	4.35 B	14

GENERAL NOTES

Begin Drilling **10-14-2013** Complete Drilling **10-14-2013**
 Drilling Contractor **Wang Testing Services** Drill Rig **D-50 TMR [78%]**
 Driller **R&N** Logger **D. Kolpacki** Checked by **C. Marin**
 Drilling Method **3.25" HSA, boring backfilled upon completion**

WATER LEVEL DATA

While Drilling ∇ **3.50 ft**
 At Completion of Drilling ∇ **40.00 ft**
 Time After Drilling **NA**
 Depth to Water ∇ **NA**

The stratification lines represent the approximate boundary between soil types; the actual transition may be gradual.

WANGENGINC 11000401.GPJ WANGENG.GDT 9/20/17



wangeng@wangeng.com
 1145 N Main Street
 Lombard, IL 60148
 Telephone: 630 953-9928
 Fax: 630 953-9938

BORING LOG 18-RWB-03

WEI Job No.: 1100-04-01

Client: **AECOM**
 Project: **Circle Interchange Reconstruction**
 Location: **Section 17, T39N, R14E of 3rd PM**

Datum: NAVD 88
 Elevation: 573.93 ft
 North: 1897759.34 ft
 East: 1171203.61 ft
 Station: 1604+97.68
 Offset: 33.9208 RT

Profile	Elevation (ft)	SOIL AND ROCK DESCRIPTION	Depth (ft)	Sample Type recovery	Sample No.	SPT Values (blw/6 in)	Qu (tsf)	Moisture Content (%)	Profile	Elevation (ft)	SOIL AND ROCK DESCRIPTION	Depth (ft)	Sample Type recovery	Sample No.	SPT Values (blw/6 in)	Qu (tsf)	Moisture Content (%)
		--%Silt=49.1-- --%Clay=18.1-- --A-4 (3)--															
			45		15	5 8 12	3.03 B	22									
			50		16	5 8 10	1.97 B	23									
	523.9	Boring terminated at 50.00 ft															
			55														
			60														

GENERAL NOTES

Begin Drilling **10-14-2013** Complete Drilling **10-14-2013**
 Drilling Contractor **Wang Testing Services** Drill Rig **D-50 TMR [78%]**
 Driller **R&N** Logger **D. Kolpacki** Checked by **C. Marin**
 Drilling Method **3.25" HSA, boring backfilled upon completion**

WATER LEVEL DATA

While Drilling ∇ **3.50 ft**
 At Completion of Drilling \blacktriangledown **40.00 ft**
 Time After Drilling **NA**
 Depth to Water ∇ **NA**

The stratification lines represent the approximate boundary between soil types; the actual transition may be gradual.



wangeng@wangeng.com
 1145 N Main Street
 Lombard, IL 60148
 Telephone: 630 953-9928
 Fax: 630 953-9938

BORING LOG 19-RWB-01

WEI Job No.: 1100-04-01

Client: **AECOM**
 Project: **Circle Interchange Reconstruction**
 Location: **Section 17, T39N, R14E of 3rd PM**

Datum: NAVD 88
 Elevation: 588.28 ft
 North: 1897670.99 ft
 East: 1171413.08 ft
 Station: 1607+21.55
 Offset: 18.1192 LT

Profile	Elevation (ft)	SOIL AND ROCK DESCRIPTION	Depth (ft)	Sample Type recovery	Sample No.	SPT Values (blw/6 in)	Qu (tsf)	Moisture Content (%)	Profile	Elevation (ft)	SOIL AND ROCK DESCRIPTION	Depth (ft)	Sample Type recovery	Sample No.	SPT Values (blw/6 in)	Qu (tsf)	Moisture Content (%)	
	588.04	inch thick, dark brown SILTY LOAM --TOPSOIL-- Dense, dark brown SILTY LOAM, trace gravel --FILL--			1	6 23 22	NP	16		566.5	--%Silt=57.5-- --%Clay=11.8-- --A-4 (2)-- Very soft to medium stiff, gray CLAY to SILTY CLAY, trace gravel			9	4 6 5	NA		
	585.3	Stiff, brown and gray SILTY CLAY LOAM, trace gravel	5		2	3 6 7	1.97 B	17				25		10	1 1 2	0.16 B	27	
	582.8	Very soft to stiff, gray CLAY to SILTY CLAY, trace gravel --L _L (%)=31, P _L (%)=17-- --%Gravel=2.2-- --%Sand=18.3-- --%Silt=47.1-- --%Clay=32.3-- --A-6 (10)--	10		3	3 3 4	1.15 B	21				30		11	1 1 2	0.25 B	27	
			10		4	1 2 3	0.33 B	24				30		12	1 1 2	0.33 B	27	
					5	1 1 1	0.08 B	25										
		--L _L (%)=31, P _L (%)=18-- --%Gravel=4.1-- --%Sand=13.3-- --%Silt=51.6-- --%Clay=31.0-- --A-6 (9)--	15		6	1 1 2	0.25 B	29				35		13	0 2 2	0.25 B	27	
	571.5	Soft, gray SILTY LOAM, trace gravel			7	1 4 10	NA											
		--L _L (%)=23, P _L (%)=16-- --%Gravel=6.9-- --%Sand=23.7--	20		8	4 3 4	0.49 B	17			--L _L (%)=34, P _L (%)=18-- --%Gravel=2.9-- --%Sand=13.1--	40		14	2 2 3	0.66 B	26	

GENERAL NOTES

Begin Drilling **10-14-2013** Complete Drilling **10-16-2013**
 Drilling Contractor **Wang Testing Services** Drill Rig **D-25 ATV [93%]**
 Driller **P&N** Logger **F. Bozga** Checked by **C. Marin**
 Drilling Method **2.25" HSA to 10', mud rotary thereafter, boring backfilled upon completion**

WATER LEVEL DATA

While Drilling ∇ **67.00 ft**
 At Completion of Drilling ∇ **mud in the borehole**
 Time After Drilling **48 hours**
 Depth to Water ∇ **15.00 ft**

The stratification lines represent the approximate boundary between soil types; the actual transition may be gradual.

WANGENGINC 11000401.GPJ WANGENG.GDT 9/20/17



wangeng@wangeng.com
 1145 N Main Street
 Lombard, IL 60148
 Telephone: 630 953-9928
 Fax: 630 953-9938

BORING LOG 19-RWB-01

WEI Job No.: 1100-04-01

Client: **AECOM**
 Project: **Circle Interchange Reconstruction**
 Location: **Section 17, T39N, R14E of 3rd PM**

Datum: NAVD 88
 Elevation: 588.28 ft
 North: 1897670.99 ft
 East: 1171413.08 ft
 Station: 1607+21.55
 Offset: 18.1192 LT

Profile	Elevation (ft)	SOIL AND ROCK DESCRIPTION	Depth (ft)	Sample Type recovery	Sample No.	SPT Values (blw/6 in)	Qu (tsf)	Moisture Content (%)	Profile	Elevation (ft)	SOIL AND ROCK DESCRIPTION	Depth (ft)	Sample Type recovery	Sample No.	SPT Values (blw/6 in)	Qu (tsf)	Moisture Content (%)
		--%Silt=49.6-- --%Clay=34.3-- --A-6 (12)--															
	526.5									526.5	Very stiff, gray CLAY, trace gravel						
			45	X	15	2 2 5	0.41 B	21			--L _L (%)=44, P _L (%)=20-- --%Gravel=1.2-- --%Sand=5.0-- --%Silt=39.6-- --%Clay=54.2-- --A-7-6 (24)--	65	X	19	5 6 7	2.13 B	30
	541.5	Stiff to hard, gray SILTY CLAY LOAM to SILTY LOAM, trace gravel								521.5	Dense, gray, medium SAND --Saturated--						
			50	X	16	3 5 8	1.48 B	23			--Change in drilling conditions at 73 ft--	70	X	20	11 13 17	NP	19
										515.3	Hard, gray SILTY CLAY LOAM, trace gravel						
		--L _L (%)=25, P _L (%)=16-- --%Gravel=6.5-- --%Sand=26.5-- --%Silt=49.4-- --%Clay=17.6-- --A-4 (3)--	55	X	17	6 11 19	4.84 B	14			--L _L (%)=29, P _L (%)=16-- --%Gravel=3.6-- --%Sand=13.5-- --%Silt=56.0-- --%Clay=26.9-- --A-6 (9)--	75	X	21	17 32 50/4	7.71 B	15
										511.5	Very dense, gray SILTY LOAM, trace gravel						
			60	X	18	14 23 31	5.41 B	18				80	X	22	37 50/5	NP	10

GENERAL NOTES

Begin Drilling **10-14-2013** Complete Drilling **10-16-2013**
 Drilling Contractor **Wang Testing Services** Drill Rig **D-25 ATV [93%]**
 Driller **P&N** Logger **F. Bozga** Checked by **C. Marin**
 Drilling Method **2.25" HSA to 10', mud rotary thereafter, boring backfilled upon completion**

WATER LEVEL DATA

While Drilling ∇ **67.00 ft**
 At Completion of Drilling ∇ **mud in the borehole**
 Time After Drilling **48 hours**
 Depth to Water ∇ **15.00 ft**

The stratification lines represent the approximate boundary between soil types; the actual transition may be gradual.

WANGENGINC 11000401.GPJ WANGENG.GDT 9/20/17



BORING LOG 19-RWB-01

wangeng@wangeng.com
 1145 N Main Street
 Lombard, IL 60148
 Telephone: 630 953-9928
 Fax: 630 953-9938

WEI Job No.: 1100-04-01

Client: **AECOM**
 Project: **Circle Interchange Reconstruction**
 Location: **Section 17, T39N, R14E of 3rd PM**

Datum: NAVD 88
 Elevation: 588.28 ft
 North: 1897670.99 ft
 East: 1171413.08 ft
 Station: 1607+21.55
 Offset: 18.1192 LT

Profile	Elevation (ft)	SOIL AND ROCK DESCRIPTION	Depth (ft)	Sample Type recovery	Sample No.	SPT Values (blw/6 in)	Qu (tsf)	Moisture Content (%)	Profile	Elevation (ft)	SOIL AND ROCK DESCRIPTION	Depth (ft)	Sample Type recovery	Sample No.	SPT Values (blw/6 in)	Qu (tsf)	Moisture Content (%)
		--HARD DRILLING-- --Possible Cobbles--															
	501.5	Very dense, gray SILT	85		23	29 34 40	NP	11									
			90		24	15 50/5	NP	18									
	494.6	DOLOSTONE fragments --DIFFICULT DRILLING--															
	493.3	--WEATHERED BEDROCK--	95		25	50/4	NP	17									
		Boring terminated at 95.00 ft															

GENERAL NOTES

WATER LEVEL DATA

Begin Drilling **10-14-2013** Complete Drilling **10-16-2013**
 Drilling Contractor **Wang Testing Services** Drill Rig **D-25 ATV [93%]**
 Driller **P&N** Logger **F. Bozga** Checked by **C. Marin**
 Drilling Method **2.25" HSA to 10', mud rotary thereafter, boring backfilled upon completion**

While Drilling ∇ **67.00 ft**
 At Completion of Drilling ∇ **mud in the borehole**
 Time After Drilling **48 hours**
 Depth to Water ∇ **15.00 ft**

The stratification lines represent the approximate boundary between soil types; the actual transition may be gradual.



BORING LOG 1087-B-02

wangeng@wangeng.com
 1145 N Main Street
 Lombard, IL 60148
 Telephone: 630 953-9928
 Fax: 630 953-9938

WEI Job No.: 1100-04-01

Client: **AECOM**
 Project: **Circle Interchange Reconstruction**
 Location: **Section 17, T39N, R14E of 3rd PM**

Datum: NAVD 88
 Elevation: 577.83 ft
 North: 1897618.19 ft
 East: 1171373.71 ft
 Station: 1225+43.65
 Offset: 53.5267 LT

Profile	Elevation (ft)	SOIL AND ROCK DESCRIPTION	Depth (ft)	Sample Type recovery	Sample No.	SPT Values (blw/6 in)	Qu (tsf)	Moisture Content (%)	Profile	Elevation (ft)	SOIL AND ROCK DESCRIPTION	Depth (ft)	Sample Type recovery	Sample No.	SPT Values (blw/6 in)	Qu (tsf)	Moisture Content (%)
	577.54	15-inch thick ASPHALT --PAVEMENT--															
	576.2	15-inch thick CONCRETE --PAVEMENT--															
		Medium dense CRUSHED STONE --FILL--			1	10 9 12	NP							9	0 2 1	0.25 B	27
					2	4 2 3	NP	7				25		10	0 0 3	0.41 B	26
	572.3	Medium stiff, gray SILTY CLAY, trace gravel			3	2 3 2	0.74 B	20						11	1 1 2	0.41 B	25
	569.8	Soft to medium stiff, gray CLAY, trace gravel			4	2 2 3	0.33 B	21						12	1 2 2	0.57 B	26
		--L _L (%)=32, P _L (%)=17-- --%Gravel=1.9-- --%Sand=15.6-- --%Silt=52.2-- --%Clay=30.3-- --A-6 (11)--			5	2 1 2	0.25 B	24									
					6	1 2 1	0.16 B	27						13	0 1 1	0.49 B	29
					7	1 2 1	0.25 B	27		541.1	Hard, gray SILTY LOAM, trace gravel and sand lenses						
					8	1 2 2	0.25 P	28						14	9 10 13	7.79 B	18

GENERAL NOTES

Begin Drilling **03-06-2013** Complete Drilling **03-14-2013**
 Drilling Contractor **Wang Testing Services** Drill Rig **B-57 TMR [100%]**
 Driller **R&J** Logger **D. Kolpacki** Checked by **C. Marin**
 Drilling Method **2.25" SSA to 20', mud rotary thereafter, boring**
backfilled upon completion

WATER LEVEL DATA

While Drilling ∇ **3.50 ft**
 At Completion of Drilling ∇ **mud in the borehole**
 Time After Drilling **NA**
 Depth to Water ∇ **NA**

The stratification lines represent the approximate boundary between soil types; the actual transition may be gradual.

WANGENGINC 11000401.GPJ WANGENG.GDT 9/20/17



BORING LOG 1087-B-02

wangeng@wangeng.com
 1145 N Main Street
 Lombard, IL 60148
 Telephone: 630 953-9928
 Fax: 630 953-9938

WEI Job No.: 1100-04-01

Client: **AECOM**
 Project: **Circle Interchange Reconstruction**
 Location: **Section 17, T39N, R14E of 3rd PM**

Datum: NAVD 88
 Elevation: 577.83 ft
 North: 1897618.19 ft
 East: 1171373.71 ft
 Station: 1225+43.65
 Offset: 53.5267 LT

Profile	Elevation (ft)	SOIL AND ROCK DESCRIPTION	Depth (ft)	Sample Type recovery	Sample No.	SPT Values (blw/6 in)	Qu (tsf)	Moisture Content (%)	Profile	Elevation (ft)	SOIL AND ROCK DESCRIPTION	Depth (ft)	Sample Type recovery	Sample No.	SPT Values (blw/6 in)	Qu (tsf)	Moisture Content (%)
											--%Clay=0.9-- --A-2-4 (0)--						
	515.8									515.8	Hard, gray SILTY LOAM, trace gravel						
		--L _L (%)=24, P _L (%)=13-- --%Gravel=3.5-- --%Sand=28.1-- --%Silt=52.4-- --%Clay=16.0-- --A-6 (5)--	45	X	15	7 10 18	6.47 B	13					X	19	12 20 25	10.25 B	13
	530.8	Very stiff to hard, gray SILTY CLAY, trace gravel															
			50	X	16	7 12 20	6.72 B	20					X	20	19 30 34	5.00 S	13
		--L _L (%)=22, P _L (%)=12-- --%Gravel=4.6-- --%Sand=19.7-- --%Silt=61.8-- --%Clay=13.9-- --A-4 (5)--															
		--L _L (%)=40, P _L (%)=15-- --%Gravel=0.4-- --%Sand=3.8-- --%Silt=49.8-- --%Clay=46.1-- --A-6 (24)--	55	X	17	6 6 7	2.05 S	24					X	21	27 34 47	4.50 P	18
	520.8	Medium dense, gray, SANDY LOAM															
		--%Gravel=0.0-- --%Sand=74.0-- --%Silt=25.1--	60	X	18	5 7 10	NP	23					X	22	50/3	NP	15
	500.8	Very dense, gray GRAVELLY SANDY LOAM, some dolostone fragments								500.8							

GENERAL NOTES

Begin Drilling **03-06-2013** Complete Drilling **03-14-2013**
 Drilling Contractor **Wang Testing Services** Drill Rig **B-57 TMR [100%]**
 Driller **R&J** Logger **D. Kolpacki** Checked by **C. Marin**
 Drilling Method **2.25" SSA to 20', mud rotary thereafter, boring backfilled upon completion**

WATER LEVEL DATA

While Drilling **3.50 ft**
 At Completion of Drilling **mud in the borehole**
 Time After Drilling **NA**
 Depth to Water **NA**

The stratification lines represent the approximate boundary between soil types; the actual transition may be gradual.

WANGENGINC 11000401.GPJ WANGENG.GDT 9/20/17



BORING LOG 1087-B-02

wangeng@wangeng.com
 1145 N Main Street
 Lombard, IL 60148
 Telephone: 630 953-9928
 Fax: 630 953-9938

WEI Job No.: 1100-04-01

Client: **AECOM**
 Project: **Circle Interchange Reconstruction**
 Location: **Section 17, T39N, R14E of 3rd PM**

Datum: NAVD 88
 Elevation: 577.83 ft
 North: 1897618.19 ft
 East: 1171373.71 ft
 Station: 1225+43.65
 Offset: 53.5267 LT

Profile	Elevation (ft)	SOIL AND ROCK DESCRIPTION	Depth (ft)	Sample Type recovery	Sample No.	SPT Values (blw/6 in)	Qu (tsf)	Moisture Content (%)	Profile	Elevation (ft)	SOIL AND ROCK DESCRIPTION	Depth (ft)	Sample Type recovery	Sample No.	SPT Values (blw/6 in)	Qu (tsf)	Moisture Content (%)
	488.8	--HARD DRILLING--	85		23	50/3	NR										
	488.8	Strong, good rock quality, light gray, fresh, slightly fractured, joint breaks with little to no infill, slightly vuggy DOLOSTONE Run#1: 89 to 99 feet --RECOVERY=100%-- --RQD=84%-- ROCK MASS RATING: Strength of rock material = 12 Drill core quality RQD = 17 Spacing of joints = 20 Condition of joints =20 Groundwater condition =10	90						CORE								
	478.8	Boring terminated at 99.00 ft	100														

GENERAL NOTES

WATER LEVEL DATA

Begin Drilling **03-06-2013** Complete Drilling **03-14-2013**
 Drilling Contractor **Wang Testing Services** Drill Rig **B-57 TMR [100%]**
 Driller **R&J** Logger **D. Kolpacki** Checked by **C. Marin**
 Drilling Method **2.25" SSA to 20', mud rotary thereafter, boring backfilled upon completion**

While Drilling ∇ **3.50 ft**
 At Completion of Drilling ∇ **mud in the borehole**
 Time After Drilling **NA**
 Depth to Water ∇ **NA**

The stratification lines represent the approximate boundary between soil types; the actual transition may be gradual.

WANGENGINC 11000401.GPJ WANGENG.GDT 9/20/17



BORING LOG 1712-B-01

wangeng@wangeng.com
 1145 N Main Street
 Lombard, IL 60148
 Telephone: 630 953-9928
 Fax: 630 953-9938

WEI Job No.: 1100-04-01

Client: **AECOM**
 Project: **Circle Interchange Reconstruction**
 Location: **Section 17, T39N, R14E of 3rd PM**

Datum: NAVD 88
 Elevation: 577.47 ft
 North: 1897623.12 ft
 East: 1171520.05 ft
 Station: 1608+41.31
 Offset: 0.4228 LT

Profile	Elevation (ft)	SOIL AND ROCK DESCRIPTION	Depth (ft)	Sample Type recovery	Sample No.	SPT Values (blw/6 in)	Qu (tsf)	Moisture Content (%)	Profile	Elevation (ft)	SOIL AND ROCK DESCRIPTION	Depth (ft)	Sample Type recovery	Sample No.	SPT Values (blw/6 in)	Qu (tsf)	Moisture Content (%)
	577.32	32-inch thick ASPHALT --PAVEMENT--															
	576.5	10-inch thick CONCRETE --PAVEMENT--															
	576.0	CRUSHED STONE --BASE COURSE--			1	7 6 6	4.26 B	12						9	1 2 2	< 0.25 P	25
	574.5	Hard, black SILTY CLAY --FILL--			2	4 3 3	0.66 B	16						10	1 2 3	0.25 B	25
		Very soft to medium stiff, CLAY to SILTY CLAY, trace gravel	5		3	1 2 3	0.49 B	16						11	1 2 3	0.33 B	16
			10		4	1 2 3	0.33 B	20						12	2 2 3	0.33 B	26
					5	1 1 2	0.16 B	25									
			15		6	1 2 2	0.25 B	26		543.5	Loose, gray SILT	35		13	3 5 4	NP	23
					7	1 1 2	0.16 B	25		540.7	Very stiff to hard, gray SILTY CLAY, trace gravel						
			20		8	1 2 1	0.25 B	26				40		14	4 6 10	2.62 B	21

GENERAL NOTES

WATER LEVEL DATA

Begin Drilling **10-27-2013** Complete Drilling **10-28-2013**
 Drilling Contractor **GSG** Drill Rig **D-50 TMR [78%]**
 Driller **J&J** Logger **C. Davis** Checked by **C. Marin**
 Drilling Method **3.25" HSA, boring backfilled upon completion**

While Drilling ∇ **57.00 ft**
 At Completion of Drilling ∇ **mud in the borehole**
 Time After Drilling **24 hours**
 Depth to Water ∇ **45.00 ft**

The stratification lines represent the approximate boundary between soil types; the actual transition may be gradual.

WANGENGINC 11000401.GPJ WANGENG.GDT 9/20/17



BORING LOG 1712-B-01

wangeng@wangeng.com
 1145 N Main Street
 Lombard, IL 60148
 Telephone: 630 953-9928
 Fax: 630 953-9938

WEI Job No.: 1100-04-01

Client: **AECOM**
 Project: **Circle Interchange Reconstruction**
 Location: **Section 17, T39N, R14E of 3rd PM**

Datum: NAVD 88
 Elevation: 577.47 ft
 North: 1897623.12 ft
 East: 1171520.05 ft
 Station: 1608+41.31
 Offset: 0.4228 LT

Profile	Elevation (ft)	SOIL AND ROCK DESCRIPTION	Depth (ft)	Sample Type recovery	Sample No.	SPT Values (blw/6 in)	Qu (tsf)	Moisture Content (%)	Profile	Elevation (ft)	SOIL AND ROCK DESCRIPTION	Depth (ft)	Sample Type recovery	Sample No.	SPT Values (blw/6 in)	Qu (tsf)	Moisture Content (%)
	515.7									515.7	Hard, gray SILTY CLAY LOAM, trace gravel						
			45		15	4 7 10	4.35 B	13				65		19	16 26 46	10.25 B	13
										510.7	Very dense, gray SILTY LOAM, little gravel						
			50		16	4 8 12	4.02 B	20				70		20	34 50 50/4	NP	11
	525.7	Soft, gray CLAY with SILT lamination --Wet--									--HARD DRILLING-- --Possible Cobbles--						
			55		17	3 3 4	0.49 B	26				75		21	30 32 33	NP	12
	520.5	Loose, gray, coarse SAND, some gravel --Saturated--									--HARD DRILLING-- --Possible Cobbles--						
			60		18	7 3 3	NP	16				80		22	50/1		14

GENERAL NOTES

Begin Drilling **10-27-2013** Complete Drilling **10-28-2013**
 Drilling Contractor **GSG** Drill Rig **D-50 TMR [78%]**
 Driller **J&J** Logger **C. Davis** Checked by **C. Marin**
 Drilling Method **3.25" HSA, boring backfilled upon completion**

WATER LEVEL DATA

While Drilling ∇ **57.00 ft**
 At Completion of Drilling ∇ **mud in the borehole**
 Time After Drilling **24 hours**
 Depth to Water ∇ **45.00 ft**

The stratification lines represent the approximate boundary between soil types; the actual transition may be gradual.

WANGENGINC 11000401.GPJ WANGENG.GDT 9/20/17



BORING LOG 1712-B-01

wangeng@wangeng.com
 1145 N Main Street
 Lombard, IL 60148
 Telephone: 630 953-9928
 Fax: 630 953-9938

WEI Job No.: 1100-04-01

Client: **AECOM**
 Project: **Circle Interchange Reconstruction**
 Location: **Section 17, T39N, R14E of 3rd PM**

Datum: NAVD 88
 Elevation: 577.47 ft
 North: 1897623.12 ft
 East: 1171520.05 ft
 Station: 1608+41.31
 Offset: 0.4228 LT

Profile	Elevation (ft)	SOIL AND ROCK DESCRIPTION	Depth (ft)	Sample Type recovery	Sample No.	SPT Values (blw/6 in)	Qu (tsf)	Moisture Content (%)	Profile	Elevation (ft)	SOIL AND ROCK DESCRIPTION	Depth (ft)	Sample Type recovery	Sample No.	SPT Values (blw/6 in)	Qu (tsf)	Moisture Content (%)
	492.0	--DIFFICULT DRILLING-- --WEATHERED BEDROCK--	85		23	50/2		11									
	490.5	Strong, light gray, good rock mass quality, bedded, fresh DOLOSTONE, 2- to 18-inch beds, 2- to 18-inch spaced joints, horizontal and vertical joints with less than 0.2-inch infilling, hard joint wall, with stylolitic surfaces, and moderately vuggy porosity, <1.5 inch vugs. --Run 1 - RECOVERY=100%-- --RQD=88%--	90						C O R E								
	480.5	Boring terminated at 97.00 ft	95		1												

GENERAL NOTES

WATER LEVEL DATA

Begin Drilling **10-27-2013** Complete Drilling **10-28-2013**
 Drilling Contractor **GSG** Drill Rig **D-50 TMR [78%]**
 Driller **J&J** Logger **C. Davis** Checked by **C. Marin**
 Drilling Method **3.25" HSA, boring backfilled upon completion**

While Drilling ∇ **57.00 ft**
 At Completion of Drilling ∇ **mud in the borehole**
 Time After Drilling **24 hours**
 Depth to Water ∇ **45.00 ft**

The stratification lines represent the approximate boundary between soil types; the actual transition may be gradual.



Boring 1712-B-01:
 Run 1#1: 87' to 97'
 RECOVERY = 100%
 RQD = 88%

BEROCK CORE: CIRCLE INTERCHANGE RECONSTRUCTION EB I-290 BRIDGE TO NB I-90/94, EN RAMP BRIDGE, SN 016-1712		
SCALE : GRAPHIC	APPENDIX C-1	DRAWN BY: A. Tomaras CHECKED BY:
		1145 N. Main Street Lombard, IL 60148 www.wangeng.com
FOR AECOM		1100-04-01



BORING LOG 1729-VST-01

wangeng@wangeng.com
 1145 N Main Street
 Lombard, IL 60148
 Telephone: 630 953-9928
 Fax: 630 953-9938

WEI Job No.: 1100-04-01

Client: **AECOM**
 Project: **Circle Interchange Reconstruction**
 Location: **Section 17, T39N, R14E of 3rd PM**

Datum: NAVD 88
 Elevation: 598.29 ft
 North: 1897455.09 ft
 East: 1171356.40 ft
 Station: 7310+33.97
 Offset: 1.45 RT

Profile	Elevation (ft)	SOIL AND ROCK DESCRIPTION	Depth (ft)	Sample Type recovery	Sample No.	SPT Values (blw/6 in)	Qu (tsf)	Moisture Content (%)	Profile	Elevation (ft)	SOIL AND ROCK DESCRIPTION	Depth (ft)	Sample Type recovery	Sample No.	SPT Values (blw/6 in)	Qu (tsf)	Moisture Content (%)
		Drilled without sampling															
			5								--In-Situ Vane Shear, 25.0 feet--	25	1				
											--S _{u undis} = 926.51 psf--						
											--S _{u remold} = 452.48 psf--						
											--Sensitivity = 2.05--						
			10								--In-Situ Vane Shear, 30.0 feet--	30	2				
											--S _{u undis} = 603.30 psf--						
											--S _{u remold} = 344.75 psf--						
											--Sensitivity = 1.75--						
	584.8	Medium dense, brown and black SANDY LOAM; trace gravel; trace brick and wood fragments; mosit	15		1	4 6 5	NP	20									
	583.0	--FILL-- Stiff, gray SILTY CLAY LOAM, trace gravel			2	3 3 4	1.07 B	21									
	581.0	--FILL-- Medium stiff, gray SILTY CLAY, trace gravel			3	2 3 3	0.57 B	21									
			20								--In-Situ Vane Shear, 35.0 feet--	35	3				
											--S _{u undis} = 592.53 psf--						
											--S _{u remold} = 301.65 psf--						
											--Sensitivity = 1.96--						
											--In-Situ Vane Shear, 40.0 feet--	40	4				

GENERAL NOTES

WATER LEVEL DATA

Begin Drilling **07-25-2016** Complete Drilling **07-26-2016**
 Drilling Contractor **Wang Testing Services** Drill Rig **D-25 ATV [93%]**
 Driller **N&N** Logger **F. Bozga** Checked by **M. Seyhun**
 Drilling Method **2.25" IDA HSA to 10', mud rotary thereafter, boring backfilled upon completion**

While Drilling **Rotary wash**
 At Completion of Drilling **Mud at 20 ft**
 Time After Drilling **NA**
 Depth to Water **NA**

The stratification lines represent the approximate boundary between soil types; the actual transition may be gradual.

WANGENGINC 11000401.GPJ WANGENG.GDT 9/20/17



BORING LOG 1729-VST-01

wangeng@wangeng.com
 1145 N Main Street
 Lombard, IL 60148
 Telephone: 630 953-9928
 Fax: 630 953-9938

WEI Job No.: 1100-04-01

Client: **AECOM**
 Project: **Circle Interchange Reconstruction**
 Location: **Section 17, T39N, R14E of 3rd PM**

Datum: NAVD 88
 Elevation: 598.29 ft
 North: 1897455.09 ft
 East: 1171356.40 ft
 Station: 7310+33.97
 Offset: 1.45 RT

Profile	Elevation (ft)	SOIL AND ROCK DESCRIPTION	Depth (ft)	Sample Type recovery	Sample No.	SPT Values (blw/6 in)	Qu (tsf)	Moisture Content (%)	Profile	Elevation (ft)	SOIL AND ROCK DESCRIPTION	Depth (ft)	Sample Type recovery	Sample No.	SPT Values (blw/6 in)	Qu (tsf)	Moisture Content (%)
		--S _{u undis} = 635.62 psf-- --S _{u remold} = 355.52 psf-- --Sensitivity = 1.78--				VS											
		--In-Situ Vane Shear, 45.0 feet--	45		5	VS											
		--S _{u undis} = 840.32 psf-- --S _{u remold} = 430.93 psf-- --Sensitivity = 1.95--															
			50		4	4 5 5	0.57 B	27									
					5	2 3 3	0.41 B	29									
		--In-Situ Vane Shear, 54.5 feet--	55		6	VS											
	542.8	--S _{u undis} = 1508.26 psf-- --S _{u remold} = 1249.71 psf-- --Sensitivity = 1.21--															
		Very stiff, gray SILTY CLAY, trace gravel			6	5 10 16	2.46 B	22									
	540.8	Boring terminated at 57.50 ft															
			60														

GENERAL NOTES

Begin Drilling **07-25-2016** Complete Drilling **07-26-2016**
 Drilling Contractor **Wang Testing Services** Drill Rig **D-25 ATV [93%]**
 Driller **N&N** Logger **F. Bozga** Checked by **M. Seyhun**
 Drilling Method **2.25" IDA HSA to 10', mud rotary thereafter, boring backfilled upon completion**

WATER LEVEL DATA

While Drilling **Rotary wash**
 At Completion of Drilling **Mud at 20 ft**
 Time After Drilling **NA**
 Depth to Water **NA**

The stratification lines represent the approximate boundary between soil types; the actual transition may be gradual.

WANGENGINC 11000401.GPJ WANGENG.GDT 9/20/17



wangeng@wangeng.com
 1145 N Main Street
 Lombard, IL 60148
 Telephone: 630 953-9928
 Fax: 630 953-9938

BORING LOG 1729-VST-02

WEI Job No.: 1100-04-01

Client: **AECOM**
 Project: **Circle Interchange Reconstruction**
 Location: **Section 17, T39N, R14E of 3rd PM**

Datum: NAVD 88
 Elevation: 592.70 ft
 North: 1897206.55 ft
 East: 1171441.79 ft
 Station: 7312+95.08
 Offset: 32.79 LT

Profile	Elevation (ft)	SOIL AND ROCK DESCRIPTION	Depth (ft)	Sample Type recovery	Sample No.	SPT Values (blw/6 in)	Qu (tsf)	Moisture Content (%)	Profile	Elevation (ft)	SOIL AND ROCK DESCRIPTION	Depth (ft)	Sample Type recovery	Sample No.	SPT Values (blw/6 in)	Qu (tsf)	Moisture Content (%)
		--S _{u undis} = 743.36 psf-- --S _{u remold} = 452.48 psf-- --Sensitivity = 1.64--															
		--In-Situ Vane Shear, 45.0 feet-- --Failed test--	45		5	VS											
		--In-Situ Vane Shear, 47.5 feet-- --S _{u undis} = 1422.08 psf-- --S _{u remold} = 775.68 psf-- --Sensitivity = 1.83--			6	VS											
		--In-Situ Vane Shear, 49.5 feet-- --S _{u undis} = 1422.07 psf-- --S _{u remold} = 775.68 psf-- --Sensitivity = 1.83--	50		7	VS											
					3		0.50 P	23									
	540.4 540.2	Hard, gray SILTY CLAY, trace gravel Boring terminated at 52.50 ft															
			55														
			60														

GENERAL NOTES

Begin Drilling **07-27-2016** Complete Drilling **07-27-2016**
 Drilling Contractor **Wang Testing Services** Drill Rig **D-25 ATV [93%]**
 Driller **N&N** Logger **F. Bozga** Checked by **M. Seyhun**
 Drilling Method **2.25" IDA HSA to 10', mud rotary thereafter, boring backfilled upon completion**

WATER LEVEL DATA

While Drilling **Rotary wash**
 At Completion of Drilling **Mud at 22.5 ft**
 Time After Drilling **NA**
 Depth to Water **NA**

The stratification lines represent the approximate boundary between soil types; the actual transition may be gradual.



wangeng@wangeng.com
 1145 N Main Street
 Lombard, IL 60148
 Telephone: 630 953-9928
 Fax: 630 953-9938

BORING LOG VST-01

WEI Job No.: 1100-04-01

Client: **AECOM**
 Project: **Circle Interchange Reconstruction**
 Location: **Section 17, T39N, R14E of 3rd PM**

Datum: NAVD 88
 Elevation: 593.55 ft
 North: 1897108.36 ft
 East: 1171435.63 ft
 Station: 7313+90.47
 Offset: 2.00 LT

Profile	Elevation (ft)	SOIL AND ROCK DESCRIPTION	Depth (ft)	Sample Type recovery	Sample No.	SPT Values (blw/6 in)	Qu (tsf)	Moisture Content (%)	Profile	Elevation (ft)	SOIL AND ROCK DESCRIPTION	Depth (ft)	Sample Type recovery	Sample No.	SPT Values (blw/6 in)	Qu (tsf)	Moisture Content (%)
		Very stiff, brown SILTY CLAY LOAM, trace gravel --FILL--			1	3 5 7	2.75 P	14			--S _{u undis} = 786.3 psf-- --S _{u remold} = 371.3 psf-- --Sensitivity = 2.1--						
	590.5	Medium dense, fine SAND	5		2	5 5 6	NP	7			--In-Situ Vane Shear, 22.0 feet-- --S _{u undis} = 742.6 psf-- --S _{u remold} = 305.8 psf-- --Sensitivity = 2.4--			2			
	586.8	Medium stiff to stiff, gray SILTY CLAY	10		3	2 2 3	1.31 B	26			--In-Situ Vane Shear, 24.5 feet-- --S _{u undis} = 578.8 psf-- --S _{u remold} = 382.2 psf-- --Sensitivity = 1.5--			3			
			15		4	2 2 3	0.98 B	28			--In-Situ Vane Shear, 27.0 feet-- --S _{u undis} = 742.6 psf-- --S _{u remold} = 415.0 psf-- --Sensitivity = 1.8--			4			
	578.0	Soft, gray SILTY CLAY			5	1 2 2	0.25 P	29			--In-Situ Vane Shear, 29.5 feet-- --S _{u undis} = 589.7 psf-- --S _{u remold} = 283.9 psf-- --Sensitivity = 2.1--			5			
	575.3										--In-Situ Vane Shear, 32.0 feet-- --S _{u undis} = 1026.6 psf-- --S _{u remold} = 447.8 psf-- --Sensitivity = 2.3--			6			
											--In-Situ Vane Shear, 34.5 feet-- --S _{u undis} = 764.5 psf-- --S _{u remold} = 480.5 psf-- --Sensitivity = 1.6--			7			
											--In-Situ Vane Shear, 37.0 feet-- --S _{u undis} = 1026.6 psf-- --S _{u remold} = 589.7 psf-- --Sensitivity = 1.7--			8			
		--In-Situ Vane Shear, 19.5 feet--	20		1												

GENERAL NOTES

Begin Drilling **12-01-2015** Complete Drilling **12-01-2015**
 Drilling Contractor **Wang Testing Services** Drill Rig **CME-55 TMR [85%]**
 Driller **R&N** Logger **F. Bozga** Checked by **A. Kurnia**
 Drilling Method **2.25" HSA to 10', mud rotary thereafter, boring**
backfilled upon completion

WATER LEVEL DATA

While Drilling **Rotary wash**
 At Completion of Drilling **mud in the borehole**
 Time After Drilling **NA**
 Depth to Water **NA**

The stratification lines represent the approximate boundary between soil types; the actual transition may be gradual.

WANGENGINC 11000401.GPJ WANGENG.GDT 9/20/17



wangeng@wangeng.com
 1145 N Main Street
 Lombard, IL 60148
 Telephone: 630 953-9928
 Fax: 630 953-9938

BORING LOG VST-01

WEI Job No.: 1100-04-01

Client: **AECOM**
 Project: **Circle Interchange Reconstruction**
 Location: **Section 17, T39N, R14E of 3rd PM**

Datum: NAVD 88
 Elevation: 593.55 ft
 North: 1897108.36 ft
 East: 1171435.63 ft
 Station: 7313+90.47
 Offset: 2.00 LT

Profile	Elevation (ft)	SOIL AND ROCK DESCRIPTION	Depth (ft)	Sample Type recovery	Sample No.	SPT Values (blw/6 in)	Qu (tsf)	Moisture Content (%)	Profile	Elevation (ft)	SOIL AND ROCK DESCRIPTION	Depth (ft)	Sample Type recovery	Sample No.	SPT Values (blw/6 in)	Qu (tsf)	Moisture Content (%)
	544.0																
		--Equipment Slipped--	45		9	VS											
		--In-Situ Vane Shear, 46.5 feet-- -- $S_{u\text{ undis}} = 1070.2$ psf-- -- $S_{u\text{ remold}} = 633.4$ psf-- --Sensitivity = 1.7--			10	VS											
		--In-Situ Vane Shear, 49.0 feet-- -- $S_{u\text{ undis}} = 1157.6$ psf-- -- $S_{u\text{ remold}} = 611.6$ psf-- --Sensitivity = 2.3-- Boring terminated at 49.50 ft	50		11	VS											
			55														
			60														

GENERAL NOTES

Begin Drilling **12-01-2015** Complete Drilling **12-01-2015**
 Drilling Contractor **Wang Testing Services** Drill Rig **CME-55 TMR [85%]**
 Driller **R&N** Logger **F. Bozga** Checked by **A. Kurnia**
 Drilling Method **2.25" HSA to 10', mud rotary thereafter, boring backfilled upon completion**

WATER LEVEL DATA

While Drilling ∇ **Rotary wash**
 At Completion of Drilling ∇ **mud in the borehole**
 Time After Drilling **NA**
 Depth to Water ∇ **NA**

The stratification lines represent the approximate boundary between soil types; the actual transition may be gradual.



wangeng@wangeng.com
 1145 N Main Street
 Lombard, IL 60148
 Telephone: 630 953-9928
 Fax: 630 953-9938

BORING LOG 1703-PZ-01

WEI Job No.: 1100-04-01

Client: **AECOM**
 Project: **Circle Interchange Reconstruction**
 Location: **Section 17, T39N, R14E of 3rd PM**

Datum: NAVD 88
 Elevation: 582.49 ft
 North: 1898127.96 ft
 East: 1171807.47 ft
 Station: 1104+74.81
 Offset: 3.30157 RT

Profile	Elevation (ft)	SOIL AND ROCK DESCRIPTION	Depth (ft)	Sample Type recovery	Sample No.	SPT Values (blw/6 in)	Qu (tsf)	Moisture Content (%)	Profile	Elevation (ft)	SOIL AND ROCK DESCRIPTION	Depth (ft)	Sample Type recovery	Sample No.	SPT Values (blw/6 in)	Qu (tsf)	Moisture Content (%)	
		--Drilled without sampling--	5								Piezometer Data: --Installed in Nov. 12, 2014 --Bentonite Seal 70 to 72 feet --Top of Sand Pack at 72 feet --Top of Screen at 75.3 feet --Screen Length 20 feet --Bottom of Screen at 95.3 feet	25						
			10								--piezometer stabilized water level reading -- --reading during well development (11/20/2014) = 32.00 feet bgs-- --reading date: 12/05/2014 = 31.10 feet bgs--	30						
			15									35						
			20									40						

GENERAL NOTES

Begin Drilling **11-10-2014** Complete Drilling **11-12-2014**
 Drilling Contractor **Wang Testing Services** Drill Rig **B-57 TMR [100%]**
 Driller **P&P** Logger **S. Woods** Checked by **C. Marin**
 Drilling Method **4.25" HSA, monitoring water well**

WATER LEVEL DATA

While Drilling ∇ **78.00 ft**
 At Completion of Drilling \blacktriangledown **NA**
 Time After Drilling **NA**
 Depth to Water ∇ **NA**

The stratification lines represent the approximate boundary between soil types; the actual transition may be gradual.



wangeng@wangeng.com
 1145 N Main Street
 Lombard, IL 60148
 Telephone: 630 953-9928
 Fax: 630 953-9938

BORING LOG 1703-PZ-01

WEI Job No.: 1100-04-01

Client: **AECOM**
 Project: **Circle Interchange Reconstruction**
 Location: **Section 17, T39N, R14E of 3rd PM**

Datum: NAVD 88
 Elevation: 582.49 ft
 North: 1898127.96 ft
 East: 1171807.47 ft
 Station: 1104+74.81
 Offset: 3.30157 RT

Profile	Elevation (ft)	SOIL AND ROCK DESCRIPTION	Depth (ft)	Sample Type recovery	Sample No.	SPT Values (blw/6 in)	Qu (tsf)	Moisture Content (%)	Profile	Elevation (ft)	SOIL AND ROCK DESCRIPTION	Depth (ft)	Sample Type recovery	Sample No.	SPT Values (blw/6 in)	Qu (tsf)	Moisture Content (%)
			45									65					
			50									70					
			55									75					
			60									80					

Piezometer Data:
 --Installed in Nov. 12, 2014
 --Bentonite Seal 70 to 72 feet
 --Top of Sand Pack at 72 feet
 --Top of Screen at 75.3 feet
 --Screen Length 20 feet
 --Bottom of Screen at 95.3 feet

GENERAL NOTES

WATER LEVEL DATA

Begin Drilling **11-10-2014** Complete Drilling **11-12-2014**
 Drilling Contractor **Wang Testing Services** Drill Rig **B-57 TMR [100%]**
 Driller **P&P** Logger **S. Woods** Checked by **C. Marin**
 Drilling Method **4.25" HSA, monitoring water well**

While Drilling ∇ **78.00 ft**
 At Completion of Drilling \blacktriangledown **NA**
 Time After Drilling **NA**
 Depth to Water ∇ **NA**

The stratification lines represent the approximate boundary between soil types; the actual transition may be gradual.



BORING LOG 1703-PZ-01

wangeng@wangeng.com
 1145 N Main Street
 Lombard, IL 60148
 Telephone: 630 953-9928
 Fax: 630 953-9938

WEI Job No.: 1100-04-01

Client: **AECOM**
 Project: **Circle Interchange Reconstruction**
 Location: **Section 17, T39N, R14E of 3rd PM**

Datum: NAVD 88
 Elevation: 582.49 ft
 North: 1898127.96 ft
 East: 1171807.47 ft
 Station: 1104+74.81
 Offset: 3.30157 RT

Profile	Elevation (ft)	SOIL AND ROCK DESCRIPTION	Depth (ft)	Sample Type recovery	Sample No.	SPT Values (blw/6 in)	Qu (tsf)	Moisture Content (%)	Profile	Elevation (ft)	SOIL AND ROCK DESCRIPTION	Depth (ft)	Sample Type recovery	Sample No.	SPT Values (blw/6 in)	Qu (tsf)	Moisture Content (%)
	482.5		85														
		Very dense, gray SILTY LOAM, trace gravel	90		1	40 42 18/3	NP	13									
		--Dry--															
			95		2	10 23 50/3	NP	20									
		--Dolostone fragments--															
			100		3	15 30/2	NP	14									
		Boring terminated at 100.00 ft															

GENERAL NOTES

WATER LEVEL DATA

Begin Drilling **11-10-2014** Complete Drilling **11-12-2014**
 Drilling Contractor **Wang Testing Services** Drill Rig **B-57 TMR [100%]**
 Driller **P&P** Logger **S. Woods** Checked by **C. Marin**
 Drilling Method **4.25" HSA, monitoring water well**

While Drilling ∇ **78.00 ft**
 At Completion of Drilling ∇ **NA**
 Time After Drilling **NA**
 Depth to Water ∇ **NA**

The stratification lines represent the approximate boundary between soil types; the actual transition may be gradual.

APPENDIX B

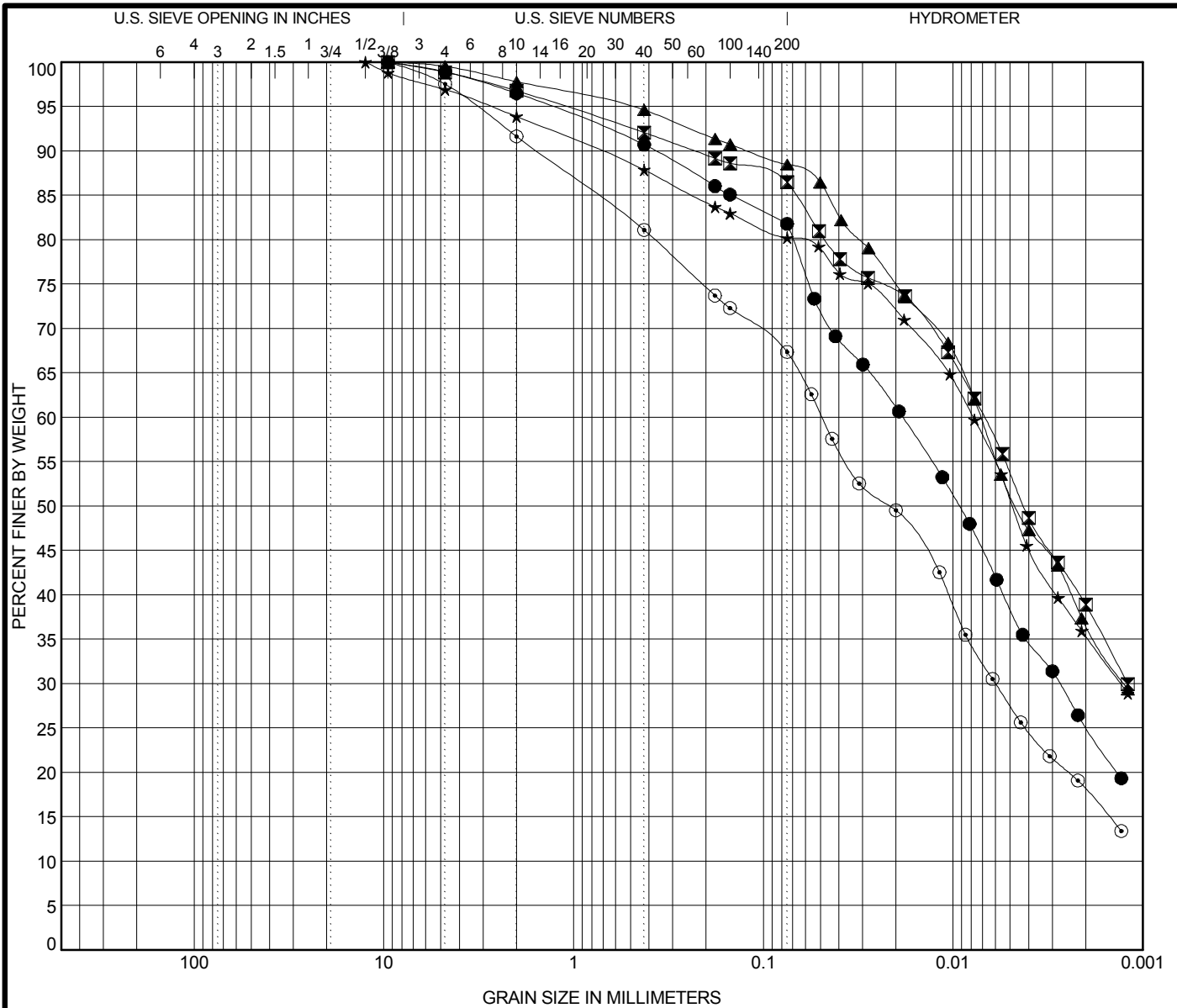

COBBLES	GRAVEL	SAND		SILT AND CLAY
		coarse	fine	

Specimen Identification			IDH Classification					LL	PL	PI	Cc	Cu
●	18-RWB-02#3	6.0 ft	Silty Clay Loam					30	16	14		
☒	18-RWB-02#12	28.5 ft	Clay					37	18	19		
▲	18-RWB-02#15	43.5 ft	Silty Clay					35	17	18		
★	18-RWB-03#6	13.5 ft	Clay					33	19	14		
⊙	18-RWB-03#14	38.5 ft	Silty Loam					24	15	9		
Specimen Identification			D100	D60	D30	D10	%Gravel	%Sand	%Silt	%Clay		
●	18-RWB-02#3	6.0 ft	9.5	0.018	0.003		3.5	15.1	56.3	25.2		
☒	18-RWB-02#12	28.5 ft	9.5	0.007	0.001		3.2	10.5	47.4	38.9		
▲	18-RWB-02#15	43.5 ft	9.5	0.007	0.001		2.2	9.4	51.7	36.7		
★	18-RWB-03#6	13.5 ft	12.5	0.008	0.001		6.1	13.7	44.9	35.3		
⊙	18-RWB-03#14	38.5 ft	9.5	0.049	0.006		8.4	24.5	49.1	18.1		



Wang Engineering, Inc.
 1145 N Main Street
 Lombard, IL 60148
 Telephone: 630 953-9928
 Fax: 630 953-9938

GRAIN SIZE DISTRIBUTION

Project: Circle Interchange Reconstruction
 Location: Section 17, T39N, R14E of 3rd PM
 Number: 1100-04-01

WEI GRAIN SIZE IDH 11000401.GPJ US LAB.GDT 9/20/17

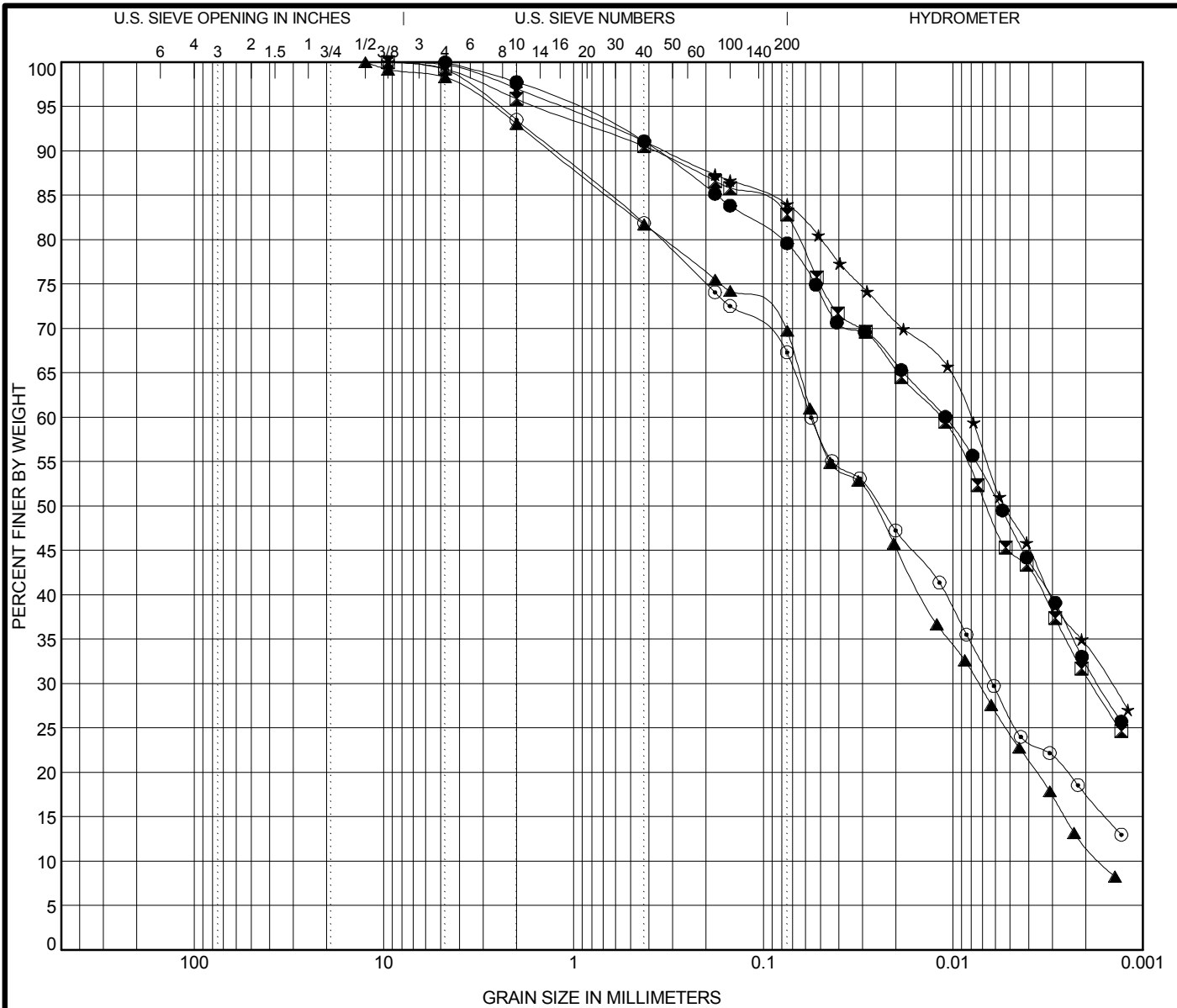

COBBLES	GRAVEL	SAND		SILT AND CLAY
		coarse	fine	

Specimen Identification			IDH Classification					LL	PL	PI	Cc	Cu
●	19-RWB-01#3	6.0 ft	Clay					31	17	14		
☒	19-RWB-01#6	13.5 ft	Silty Clay					31	18	13		
▲	19-RWB-01#8	18.5 ft	Silty Loam					23	16	7	0.59	32.74
★	19-RWB-01#14	38.5 ft	Silty Clay					34	18	16		
◎	19-RWB-01#17	53.5 ft	Silty Loam					25	16	9		
Specimen Identification			D100	D60	D30	D10	%Gravel	%Sand	%Silt	%Clay		
●	19-RWB-01#3	6.0 ft	4.75	0.011	0.002		2.2	18.3	47.1	32.3		
☒	19-RWB-01#6	13.5 ft	9.5	0.012	0.002		4.1	13.3	51.6	31.0		
▲	19-RWB-01#8	18.5 ft	12.5	0.055	0.007	0.002	6.9	23.7	57.5	11.8		
★	19-RWB-01#14	38.5 ft	9.5	0.008	0.001		2.9	13.1	49.6	34.3		
◎	19-RWB-01#17	53.5 ft	9.5	0.056	0.006		6.5	26.5	49.4	17.6		

WEI GRAIN SIZE IDH 11000401.GPJ US_LAB.GDT 9/20/17



Wang Engineering, Inc.
 1145 N Main Street
 Lombard, IL 60148
 Telephone: 630 953-9928
 Fax: 630 953-9938

GRAIN SIZE DISTRIBUTION

Project: Circle Interchange Reconstruction
 Location: Section 17, T39N, R14E of 3rd PM
 Number: 1100-04-01

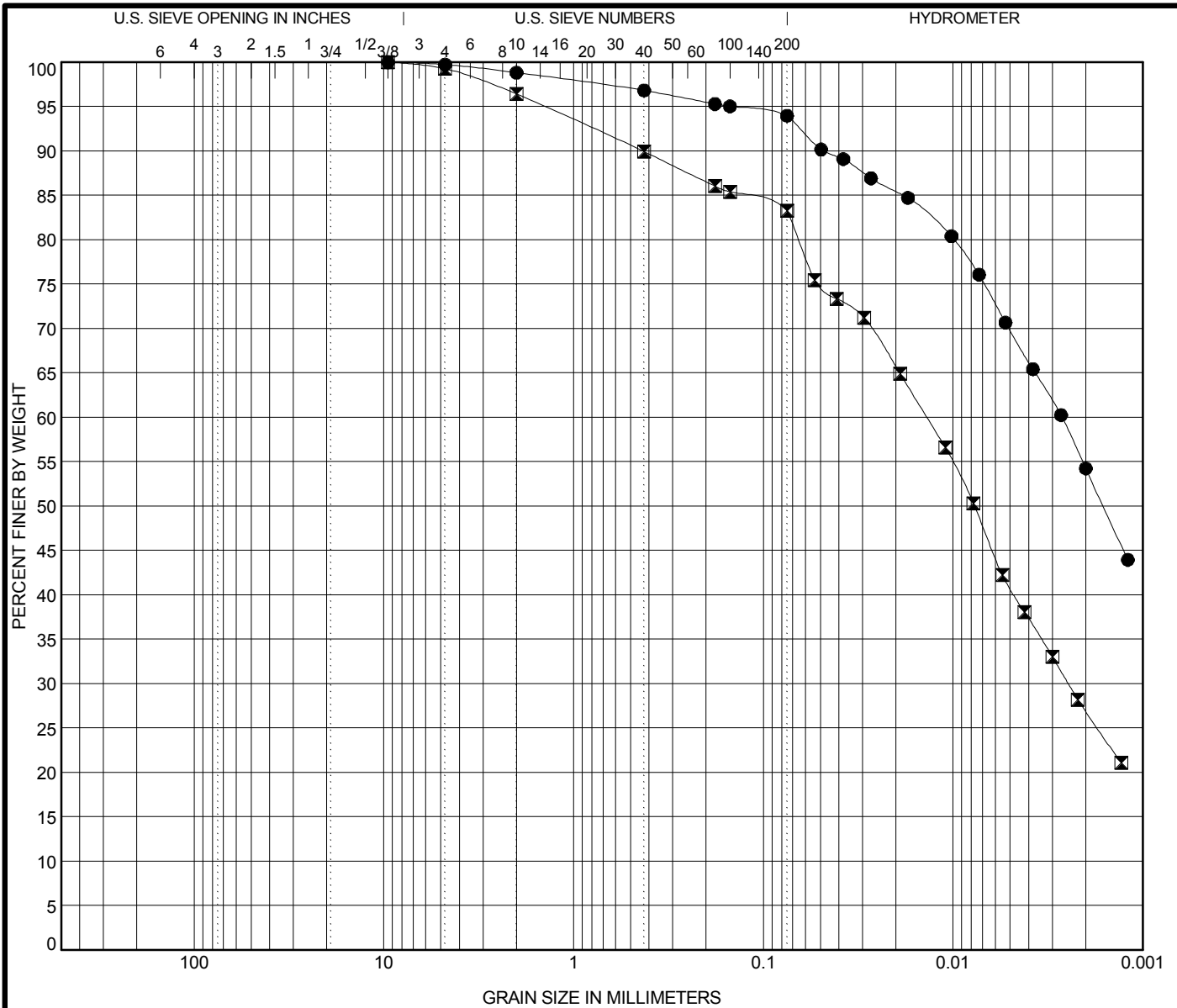

APPENDIX C

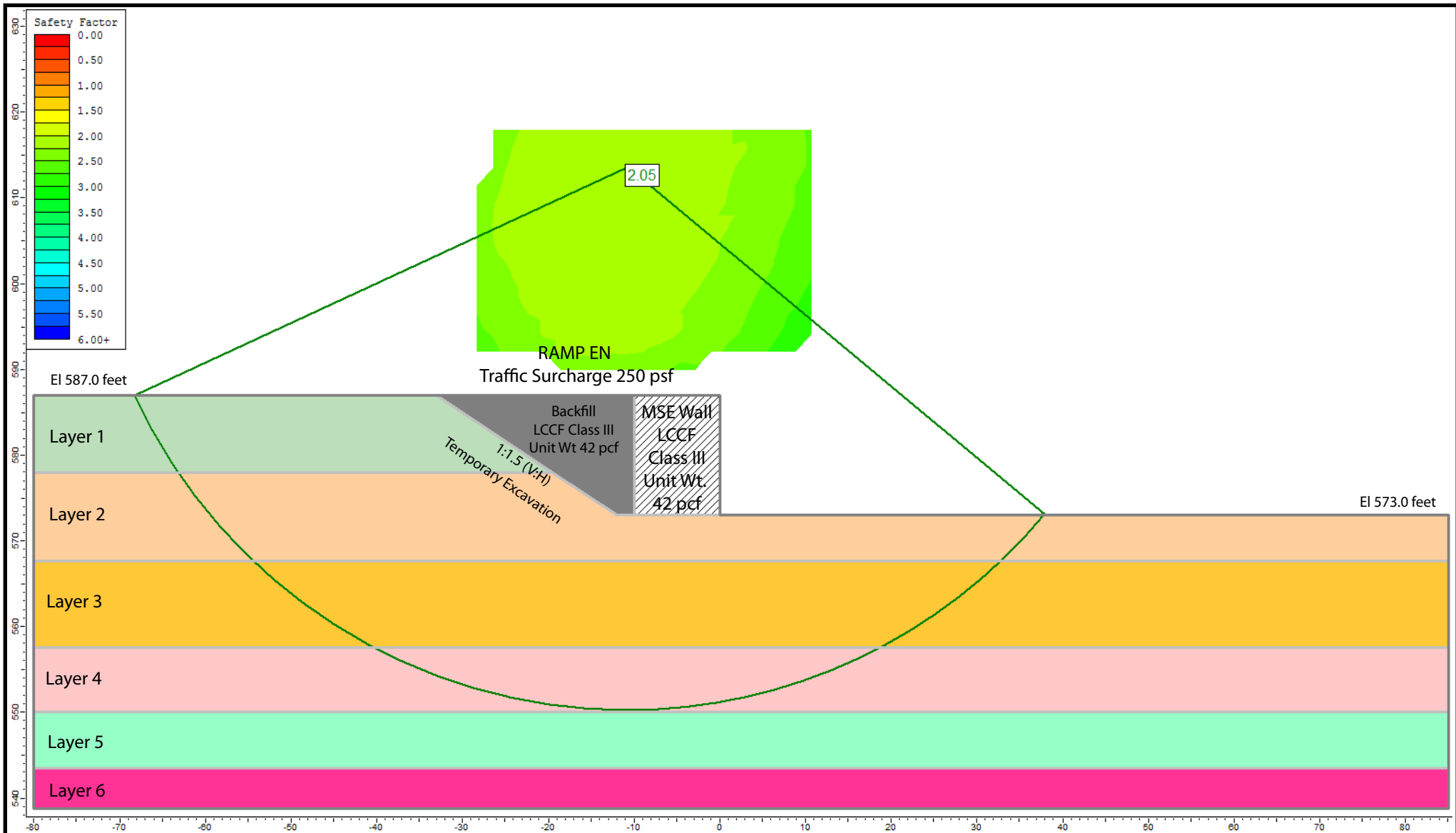

Undrained Analysis for MSE Wall at Station 1606+20.00, Ref Borings 18-RWB-02 and VST-01

Layer ID	Description	Unit Weight (pcf)	Undrained Cohesion (psf)	Undrained Friction Angle (degrees)
1	M Stiff to Stiff SI CL	115	1000	0
2	Soft to M Stiff SI CL LOAM	115	800	0
3	V Soft to M Stiff CL to SI CL	110	650	0
4	V Soft to M Stiff CL to SI CL	110	550	0
5	V Soft to M Stiff CL to SI CL	110	720	0
6	V Soft to M Stiff CL to SI CL	115	900	0

GLOBAL STABILITY ANALYSIS: CIRCLE INTERCHANGE RECONSTRUCTION, RETAINING WALL 18, SN 016-1807, CHICAGO, IL

SCALE: GRAPHICAL

APPENDIX C-1

DRAWN BY: R. Gorlagunta
CHECKED BY: M. Seyhun



1145 N. Main Street
Lombard, IL 60148
www.wangeng.com

FOR AECOM

1100-04-01

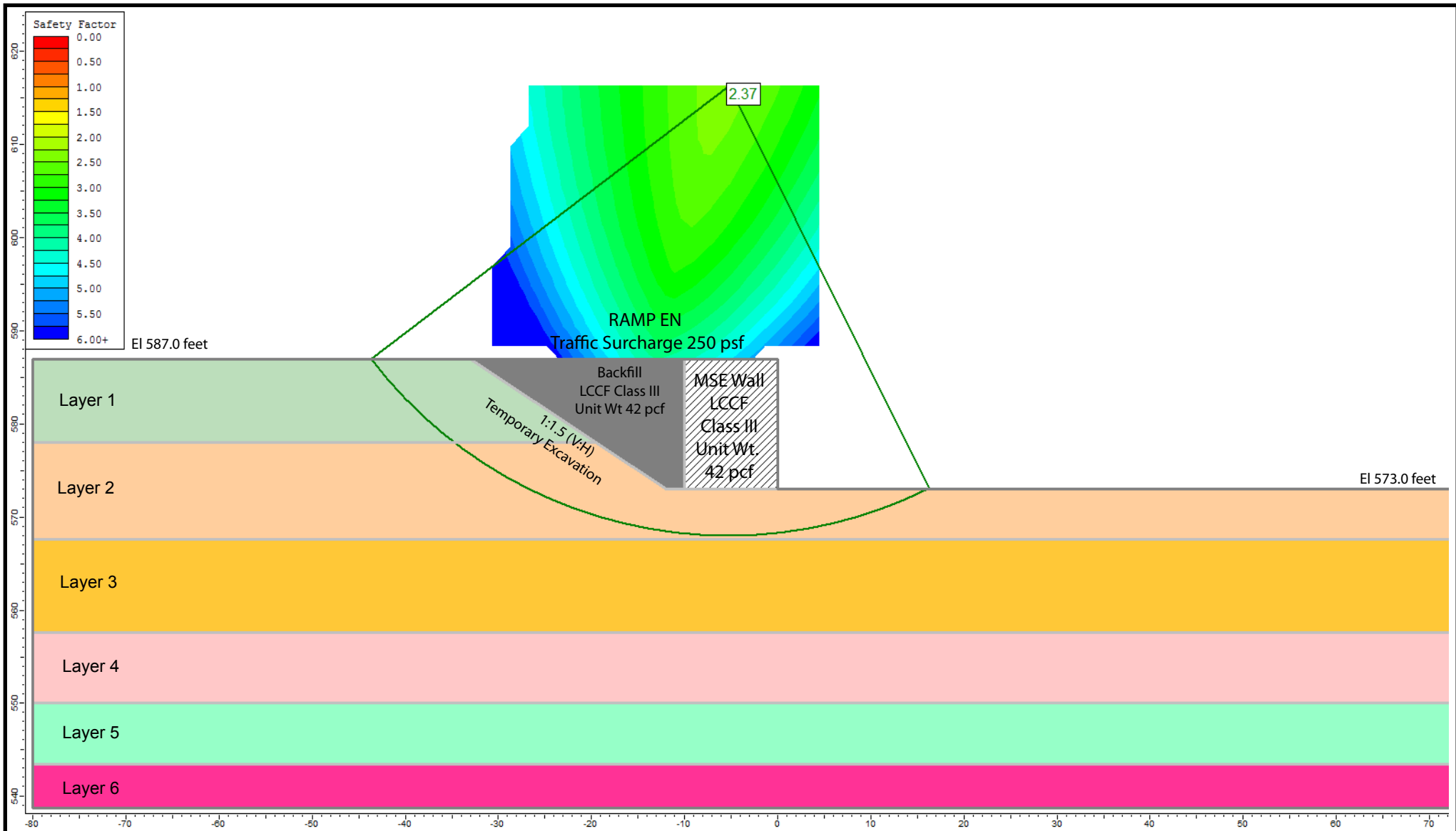

Drained Analysis for MSE Wall at Station 1606+20.00, Ref Borings 18-RWB-02 and VST-01

Layer ID	Description	Unit Weight (pcf)	Drained Cohesion (psf)	Drained Friction Angle (degrees)
1	M Stiff to Stiff SI CL	115	100	29
2	Soft to M Stiff SI CL LOAM	115	50	29
3	V Soft to M Stiff CL to SI CL	110	50	29
4	V Soft to M Stiff CL to SI CL	110	50	29
5	V Soft to M Stiff CL to SI CL	110	50	29
6	V Soft to M Stiff CL to SI CL	115	50	29

GLOBAL STABILITY ANALYSIS: CIRCLE INTERCHANGE RECONSTRUCTION, RETAINING WALL 18, SN 016-1807, CHICAGO, IL

SCALE: GRAPHICAL

APPENDIX C-2

DRAWN BY: R. Gorlagunta
CHECKED BY: M. Seyhun



1145 N. Main Street
Lombard, IL 60148
www.wangeng.com

FOR AECOM

1100-04-01

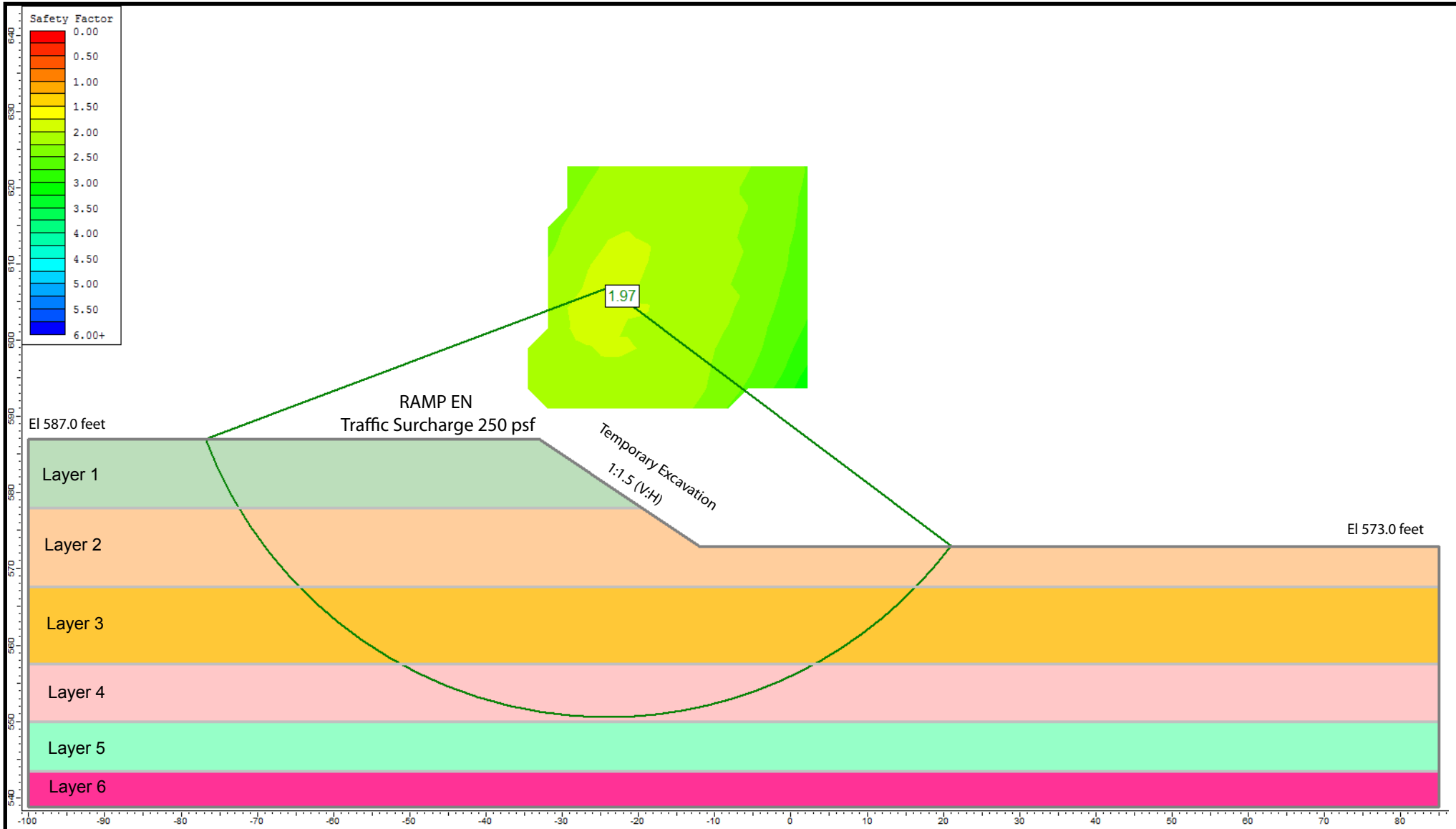

Undrained Analysis for MSE Wall at Station 1606+20.00, Ref Borings 18-RWB-02 and VST-01

Layer ID	Description	Unit Weight (pcf)	Undrained Cohesion (psf)	Undrained Friction Angle (degrees)
1	M Stiff to Stiff SI CL	115	1000	0
2	Soft to M Stiff SI CL LOAM	115	800	0
3	V Soft to M Stiff CL to SI CL	110	650	0
4	V Soft to M Stiff CL to SI CL	110	550	0
5	V Soft to M Stiff CL to SI CL	110	720	0
6	V Soft to M Stiff CL to SI CL	115	900	0

GLOBAL STABILITY ANALYSIS: CIRCLE INTERCHANGE RECONSTRUCTION, RETAINING WALL 18, SN 016-1807, CHICAGO, IL

SCALE: GRAPHICAL

APPENDIX C-3

DRAWN BY: R. Gorlagunta
CHECKED BY: M. Seyhun



1145 N. Main Street
Lombard, IL 60148
www.wangeng.com

FOR AECOM

1100-04-01

APPENDIX D

HIGHWAY CLASSIFICATION

Ramp EN Functional Class: Interstate ADT: 26,600 (2012); 31,000 (2040) ADTT: 1,032 (2012); 1,203 (2040) DHV: 1,910 (2040) Design Speed: 30 m.p.h. Posted Speed: 30 m.p.h. One-Way Traffic Directional Distribution: 100%	I-90/94 SB at Van Buren Functional Class: Interstate ADT: 100,100 (2012); 98,000 (2040) ADTT: 11,351 (2012); 11,113 (2040) DHV: 6,340 (2040) Design Speed: 60 m.p.h. Posted Speed: 45 m.p.h. One-Way Traffic Directional Distribution: 100%
--------------------------------------------------------------------------------------------------------------------------------------------------------------------------------------------------------------------------------------------------	---------------------------------------------------------------------------------------------------------------------------------------------------------------------------------------------------------------------------------------------------------------------

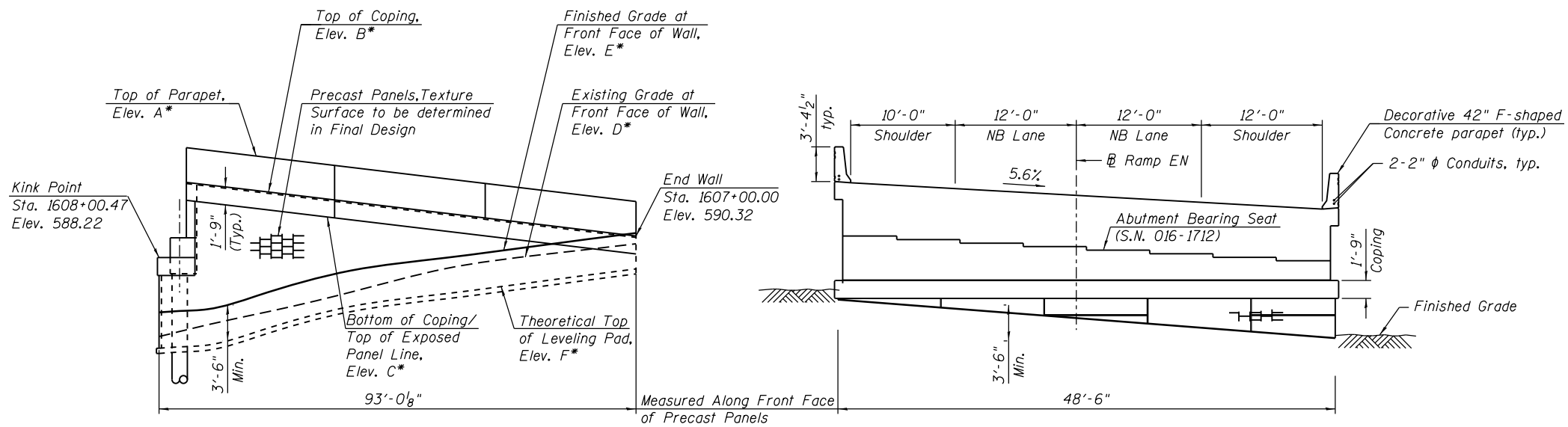

PARTIAL UNFOLDED ELEVATION
(Looking at Front Face of Wall)

NOTES:

- All Lightweight Cellular Concrete Fill shall be Class III (42 psf).
- For additional Notes, see Sheet 1.

* For Elevations, see Table 1 - Wall Elevations on Sheet 3 of 3.

** Abutment soil reinforcement to resist lateral loads in lieu of drilled shafts.

*** Size, spacing, depth and number as required by design.

**** The MSE Wall supplier's internal stability design shall account for the anchorage slab's bearing pressure surcharge of 1 ksf and horizontal sliding force of 0.83 kips/ft of wall.

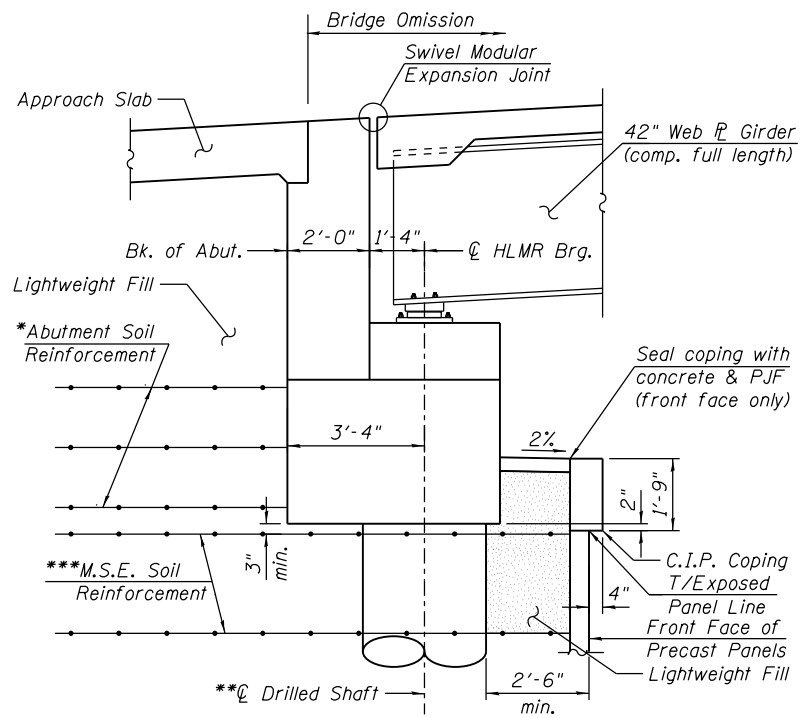

SECTION THRU WEST ABUTMENT
(Horiz. Dims. @ Rt. L's to C/Brg.)

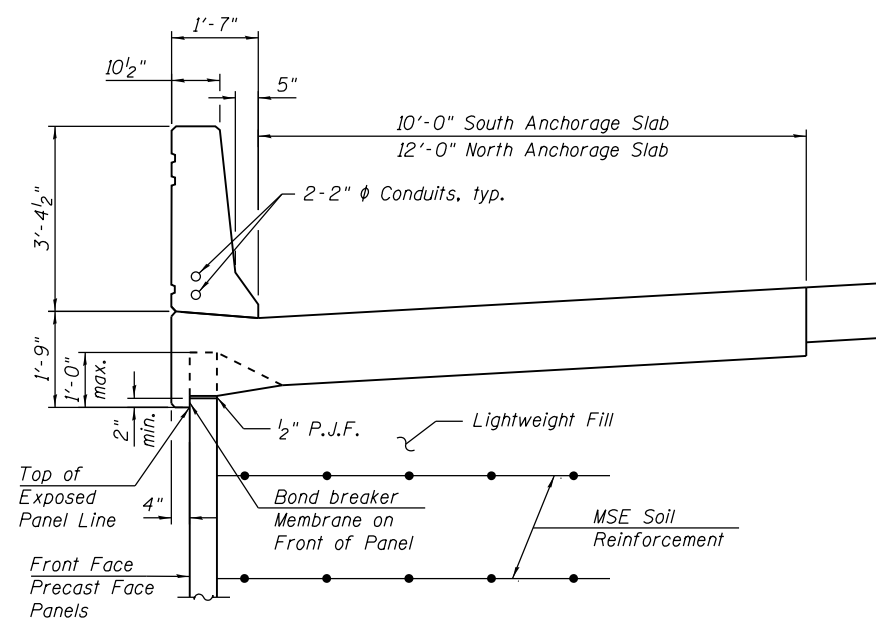

SECTION THROUGH PARAPET AND ANCHORAGE SLAB

ELEVATIONS
RETAINING WALL 18
F.A.I. RTE. 90/94/290 - SECTION 2014-005R&B
COOK COUNTY
STA. 1605+00.00 TO 1607+99.89
STRUCTURE NO. 016-1807

FILE PATH = p:\61779-P\INT.dwg; USER = JCS; DATE = 9/22/2017; TIME = 1:58:11 PM; PROJECT = 1607+99.89; SHEET = 2 OF 3

HBM
ENGINEERING GROUP, LLC
CONSULTING & DESIGN
INSPECTION & RATING
RESEARCH & TESTING

4415 WEST HARRISON ST.
SUITE 231
MILLSIDE, IL 60162
PHONE: (708) 236-0900
FAX: (708) 236-0901

USER NAME = Stoyanka,Kotorakova	DESIGNED - MI, JJS	REVISED -
	DRAWN - SK	REVISED -
PLOT SCALE = 28.00' / in.	CHECKED - MAI, MI	REVISED -
PLOT DATE = 9/22/2017	DATE - 09/22/2017	REVISED -

STATE OF ILLINOIS
DEPARTMENT OF TRANSPORTATION

STRUCTURE NO. 016-1807

SCALE: SHEET 2 OF 3 SHEETS STA. TO STA.

F.A.I. RTE.	SECTION	COUNTY	TOTAL SHEETS	SHEET NO.
90/94/290	2014-005R&B	COOK	3	2
CONTRACT NO. 60X79			ILLINOIS FED. AID PROJECT	

TABLE 1 - WALL ELEVATIONS

Station	Offset	Elevation A	Elevation B	Elevation C	Elevation D	Elevation E	Elevation F
1605+00.00	23.25 Rt.	583.55	580.18	578.43	574.47	580.06	576.56
1605+20.00	23.25 Rt.	584.63	581.26	579.51	574.66	580.11	576.61
1605+40.00	23.25 Rt.	585.70	582.33	580.58	575.00	580.27	576.77
1605+60.00	23.25 Rt.	586.85	583.48	581.73	575.32	580.49	576.99
1605+80.00	23.25 Rt.	588.07	584.70	582.95	575.69	580.71	577.21
1606+00.00	23.25 Rt.	589.31	585.94	584.19	576.12	580.95	577.45
1606+20.00	23.25 Rt.	590.64	587.27	585.52	576.54	581.15	577.65
1606+40.00	23.25 Rt.	591.98	588.61	586.86	576.96	581.01	577.51
1606+47.54	23.25 Rt.	592.47	589.09	587.34	576.96	581.01	577.51
1606+60.00	23.25 Rt.	593.33	589.96	588.21	577.32	580.85	577.35
1606+80.00	23.25 Rt.	594.63	591.26	589.51	577.69	581.03	577.53
1607+00.00	23.25 Rt.	595.87	592.50	590.75	584.84	581.49	577.99
1607+20.00	23.25 Rt.	597.11	593.74	591.99	584.11	582.61	579.11
1607+40.00	23.25 Rt.	598.35	594.98	593.23	583.23	583.23	579.73
1607+60.00	23.25 Rt.	599.59	596.22	594.47	584.61	585.18	581.68
1607+80.00	23.25 Rt.	600.70	597.33	595.58	583.23	588.46	594.96
1607+99.89	23.25 Rt.	591.60	588.22	586.47	581.72	586.62	583.12
1608+00.47	25.25 Lt.	589.85	586.47	588.20	580.52	582.87	579.37
1607+80.00	25.25 Lt.	598.13	594.76	593.01	582.69	584.46	580.96
1607+60.00	25.25 Lt.	597.02	593.65	591.90	584.85	586.95	583.45
1607+40.00	25.25 Lt.	595.91	592.54	590.79	587.15	588.20	584.70
1607+20.00	25.25 Lt.	594.80	591.43	589.68	588.49	589.41	585.91
1607+00.00	25.25 Lt.	593.69	590.32	588.57	589.56	590.62	587.12

Elevation A - Top of Parapet

Elevation B - Top of Coping

Elevation C - Bottom of Coping/Top of Exposed Panel Line

Elevation D - Exist. Grade at Front Face of Wall

Elevation E - Finished Grade at Front Face of Wall

Elevation F - Theoretical Top of Leveling Pad

NOTES:

- All lightweight cellular concrete fill shall be class III (42 pcf).
- The MSE wall supplier's internal stability design shall account for the anchorage slab's bearing pressure surcharge of 1.0 ksf and horizontal sliding force of 0.83 kips/ft. of wall.
- F.F. denotes Front Face.
- For additional notes, see Sheet 1.

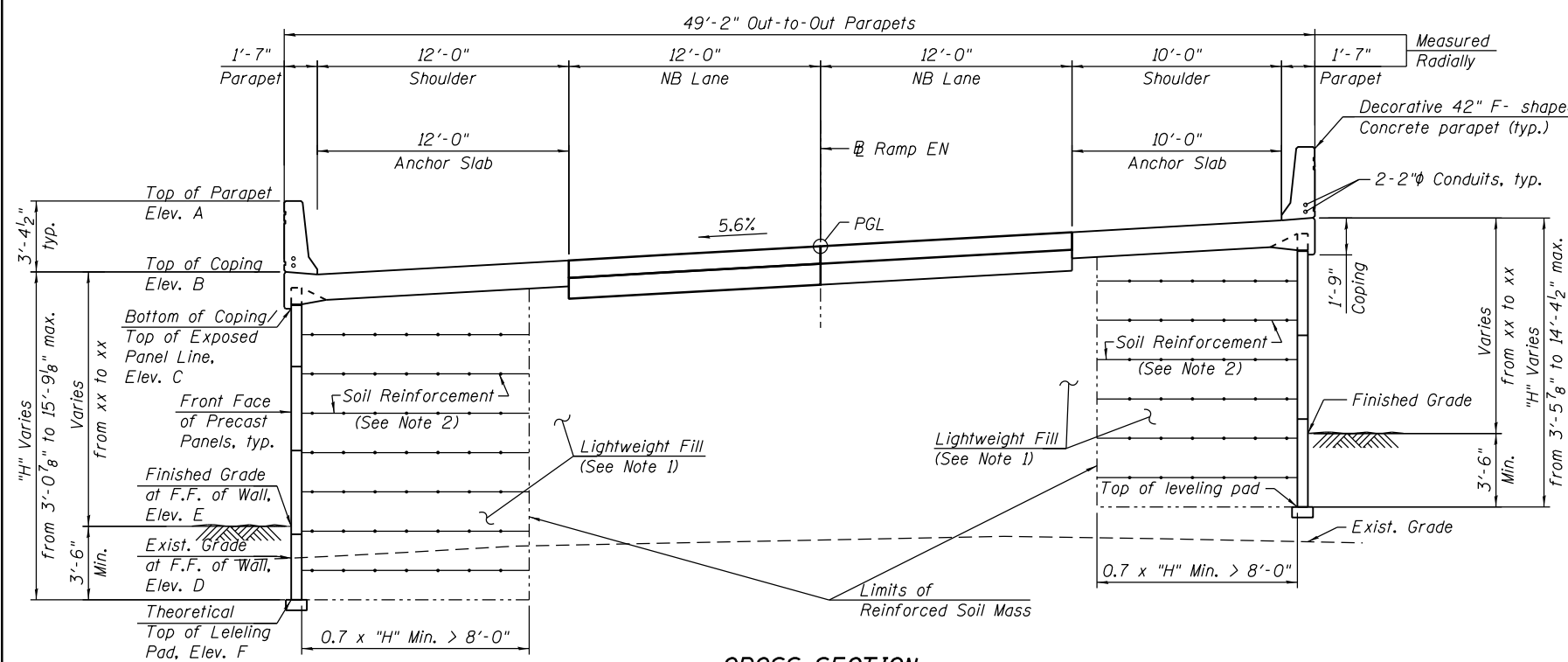

CROSS SECTION
(Looking Upstation)

CURVE DATA

(RAMP EN)
(PROP. CURVE P-CIR-EN-2)
PI STA. = 1624+41.43
Δ = 158° 32' 09" (LT)
D = 16° 51' 06"
R = 340.00'
T = 1,793.89'
L = 940.77'
E = 1,485.82'
e = 5.60%
T.R. = 36'
S.E. RUN = 102'
P.C. STA. = 1606+47.54
P.T. STA. = 1615+88.31
DS = 30
PS = 30

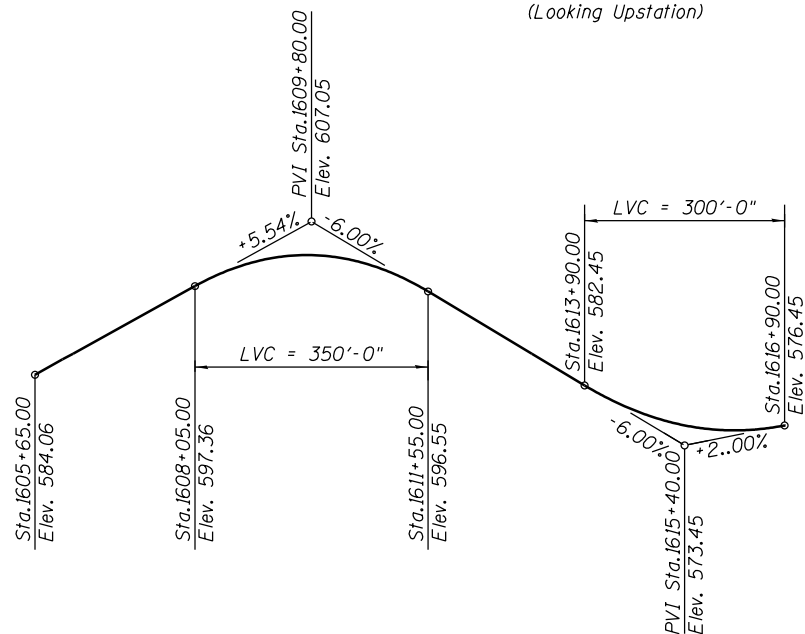

PROFILE GRADE
(Along @ Ramp EN)

CURVE DATA

(SB I-90/94)
(PROP. CURVE P-KDR-SB-4)
PI STA. = 6231+84.46
Δ = 13° 18' 21" (LT)
D = 2° 44' 34"
R = 2,089.00'
T = 243.66'
L = 485.13'
E = 14.16'
e = 4.40%
T.R. = NA
S.E. RUN = 164'
P.C. STA. = 6229+40.80
P.T. STA. = 6234+25.93
DS = 60
PS = 45

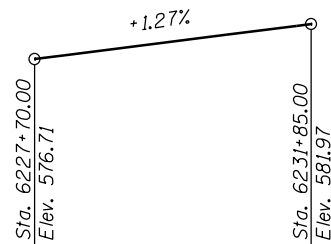

PROFILE GRADE
(Along @ SB I-90/94)

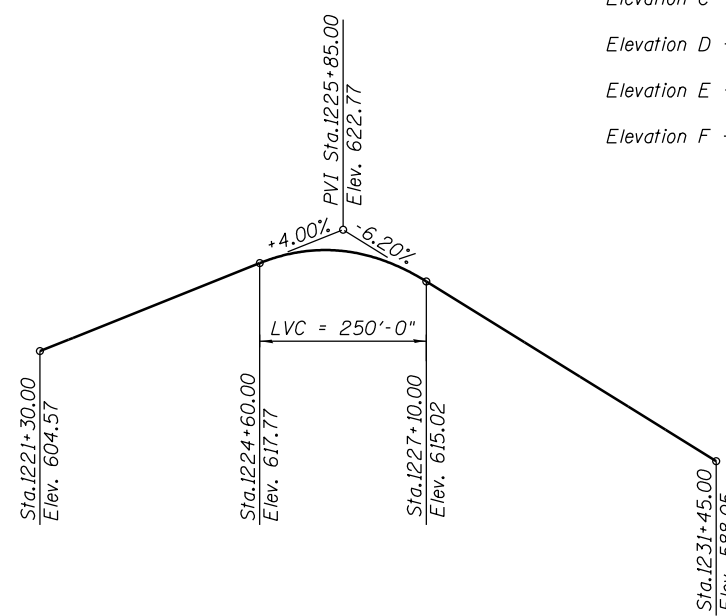

PROFILE GRADE
(Along @ Ramp WS)

SECTIONS
RETAINING WALL 18
F.A.I. RTE. 90/94/290 - SECTION 2014-005R&B
COOK COUNTY
STA. 1605+00.00 TO STA. 1607+99.89
STRUCTURE NO. 016-1807

HBM
ENGINEERING GROUP, LLC
CONSULTING & DESIGN
INSPECTION & TESTING
RESEARCH & TESTING

USER NAME = Stojenka,Kotorakova	DESIGNED - MI, JJS	REVISED -
	DRAWN - SK	REVISED -
PLOT SCALE = 8:0.0000 '1' = 1"	CHECKED - MAI, MI	REVISED -
PLOT DATE = 9/22/2017	DATE - 09/22/2017	REVISED -

STATE OF ILLINOIS
DEPARTMENT OF TRANSPORTATION

STRUCTURE NO. 016-1807

SCALE: SHEET 3 OF 3 SHEETS STA. TO STA.

F.A.I. RTE. 90/94/290	SECTION 2014-005R&B	COUNTY COOK	TOTAL SHEETS 3	SHEET NO. 3
CONTRACT NO. 60X79			ILLINOIS FED. AID PROJECT	

APPENDIX E

DATE	
BY	
FINAL SURVEY NO.	
SURVEYED PLOTTED	
NOTE BOOK	
AREAS CHECKED	

DATE	
BY	
ORIGINAL SURVEY NO.	
SURVEYED PLOTTED	
NOTE BOOK	
AREAS CHECKED	

FILE PATH = C:\Users\jshveoz\Desktop\camp_en.tbl 20170919\CIRCLE00-SHT-42M-CV-RampEN.Cross.Section.dgn

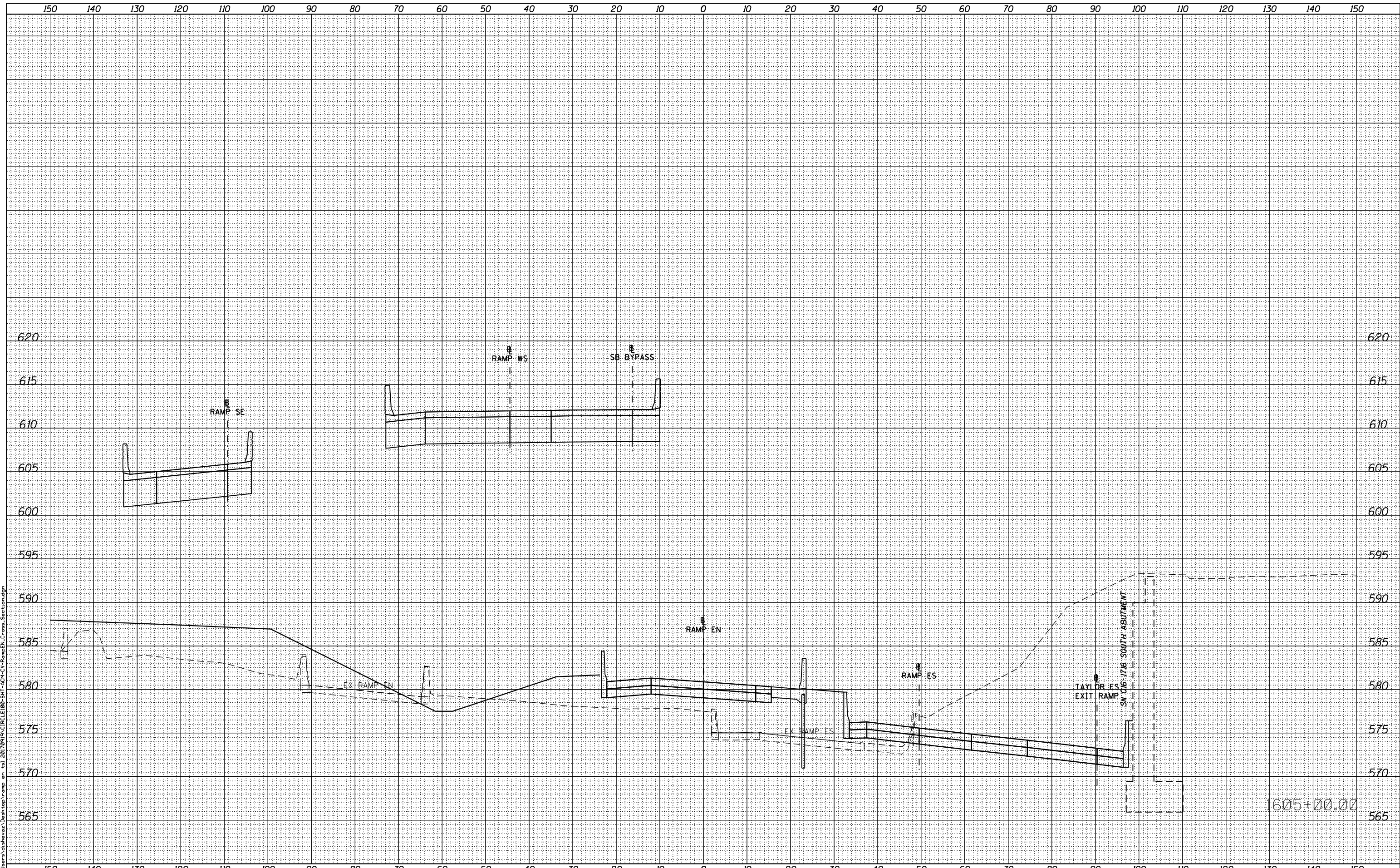

XS.SHEET	DESIGNED -	REVISED -
USER NAME = dishevoz	DRAWN -	REVISED -
PLOT SCALE = 20.0000' / in.	CHECKED -	REVISED -
PLOT DATE = 9/19/2017	DATE -	REVISED -

**STATE OF ILLINOIS
DEPARTMENT OF TRANSPORTATION**

CROSS SECTIONS - RAMP EN

SCALE: SHEET 6 OF 36 SHEETS STA. 1605+00.00 TO STA. 1605+00.00

F.A. RTE.	SECTION	COUNTY	TOTAL SHEETS	SHEET NO.
			36	
CONTRACT NO.				
ILLINOIS FED. AID PROJECT				

DATE	
BY	
ORIGINAL SURVEY NO.	
SURVEYED PLOTTED AREAS CHECKED	
FINAL SURVEY NO.	
NOTE BOOK NO.	
TEMPLATE AREAS CHECKED	

DATE	
BY	
ORIGINAL SURVEY NO.	
SURVEYED PLOTTED AREAS CHECKED	
FINAL SURVEY NO.	
NOTE BOOK NO.	
TEMPLATE AREAS CHECKED	

FILE PATH = C:\Users\jshivez\Desktop\camp_en.tbl 20170919\CIRCLE00-SHT-4CM-CV-RampEN.Cross.Section.dgn

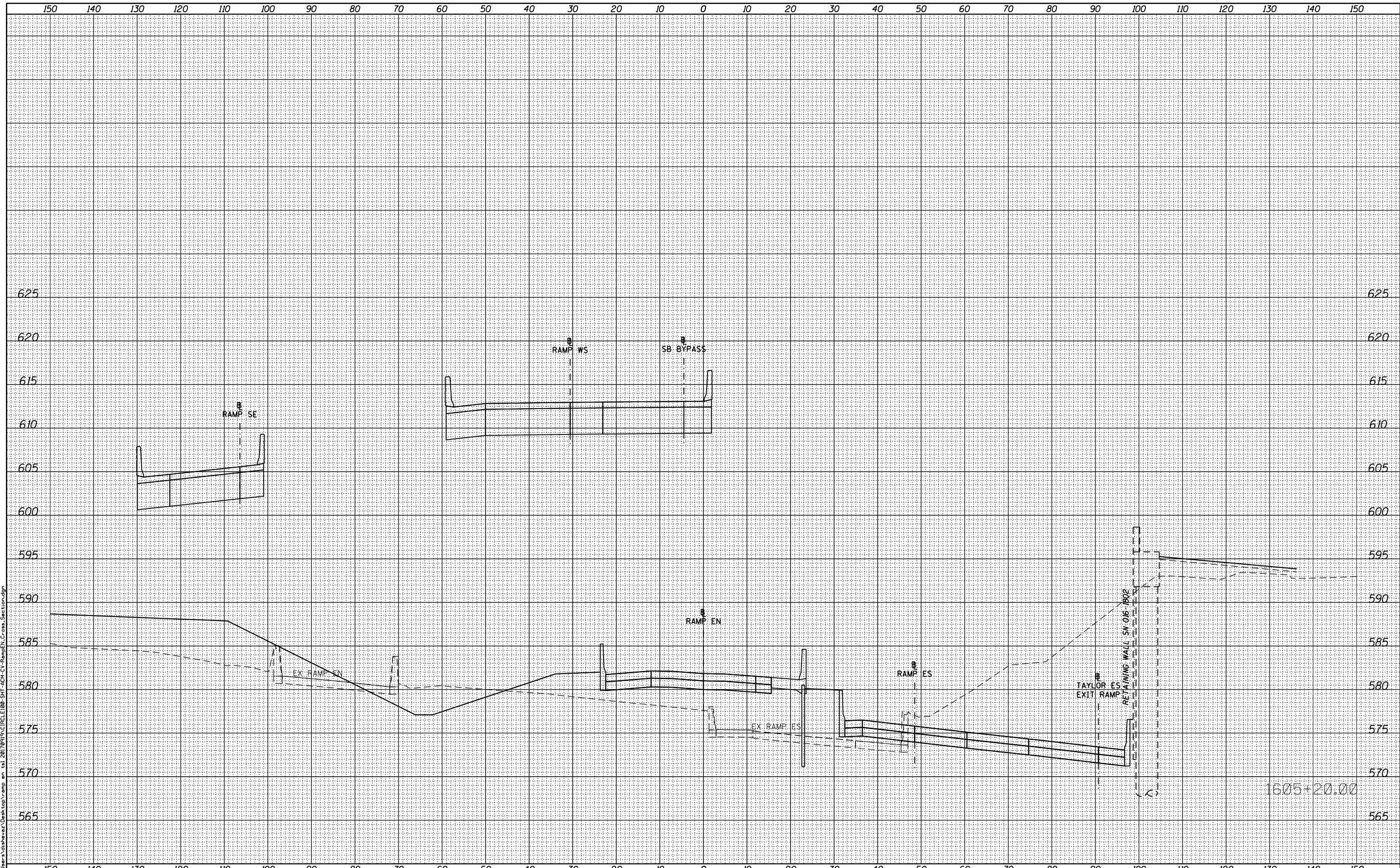

XS.SHEET	DESIGNED -	REVISED -
USER NAME = dishveoz	DRAWN -	REVISED -
PLOT SCALE = 20.0000' / in.	CHECKED -	REVISED -
PLOT DATE = 9/19/2017	DATE -	REVISED -

**STATE OF ILLINOIS
DEPARTMENT OF TRANSPORTATION**

CROSS SECTIONS - RAMP EN

SCALE: SHEET 7 OF 36 SHEETS STA. 1605+20.00 TO STA. 1605+20.00

F.A. RTE.	SECTION	COUNTY	TOTAL SHEETS	SHEET NO.
			36	
CONTRACT NO.				
ILLINOIS FED. AID PROJECT				

BY	DATE
ORIGINAL SURVEY	SURVEYED
NOTE BOOK	PLOTTED
NO.	AREAS CHECKED
	AREAS CHECKED

BY	DATE
ORIGINAL SURVEY	SURVEYED
NOTE BOOK	PLOTTED
NO.	AREAS CHECKED
	AREAS CHECKED

FILE PATH = C:\Users\dishevoz\Desktop\camp_en.tbl 20170915\CIRCLE\00-SHT-4M-CV-RampEN\Cross_Section.dgn

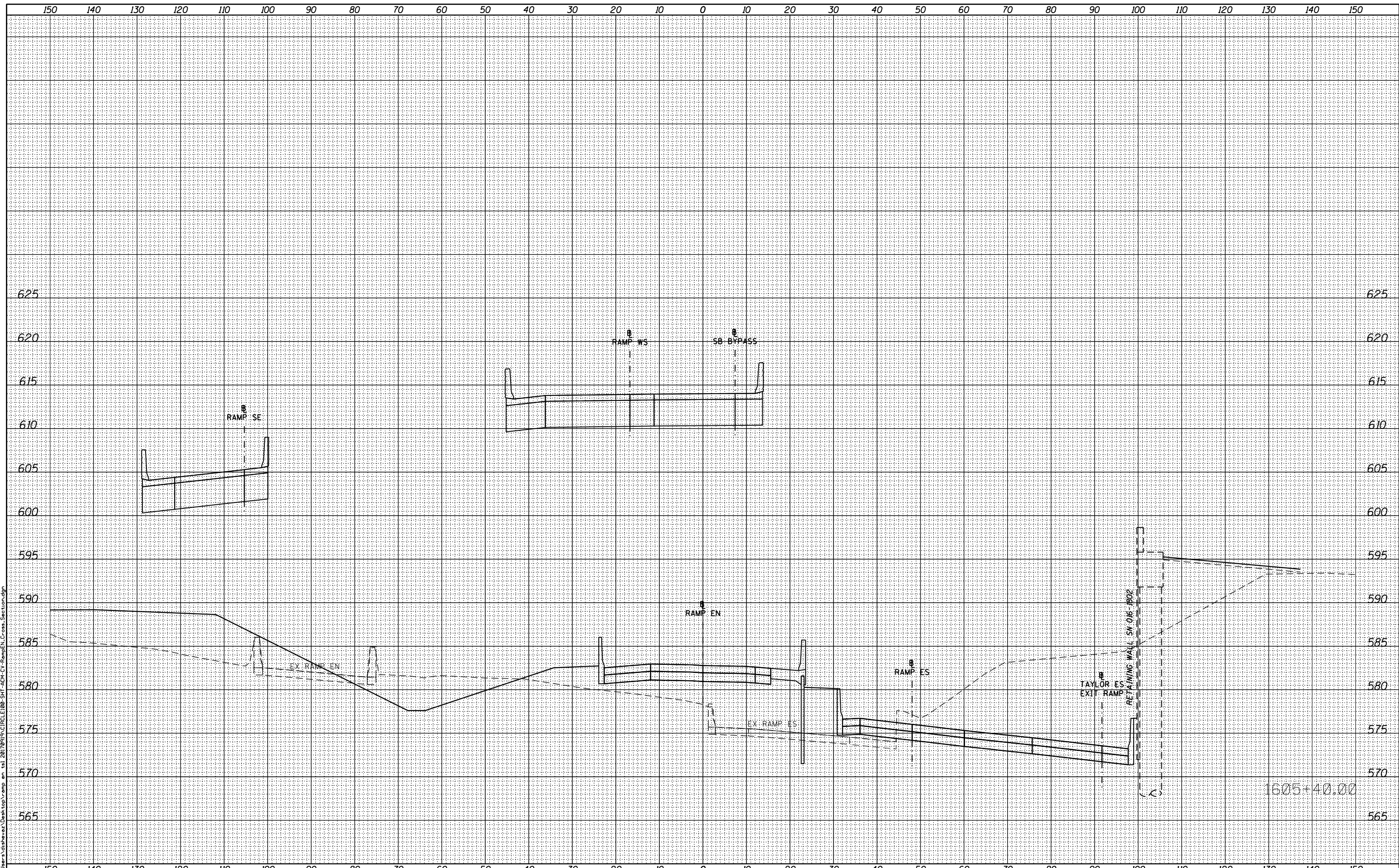

XS.SHEET	DESIGNED -	REVISED -
USER NAME = dishevoz	DRAWN -	REVISED -
PLOT SCALE = 20.0000' / in.	CHECKED -	REVISED -
PLOT DATE = 9/19/2017	DATE -	REVISED -

**STATE OF ILLINOIS
DEPARTMENT OF TRANSPORTATION**

CROSS SECTIONS - RAMP EN

SCALE: SHEET 8 OF 36 SHEETS STA. 1605+40.00 TO STA. 1605+40.00

F.A. RTE.	SECTION	COUNTY	TOTAL SHEETS	SHEET NO.
			36	
			CONTRACT NO.	
ILLINOIS FED. AID PROJECT				

DATE	
BY	
ORIGINAL SURVEY NO.	
SURVEYED PLOTTED AREAS CHECKED	
FINAL SURVEY NO.	
NOTE BOOK NO.	
TEMPLATE AREAS CHECKED	

DATE	
BY	
ORIGINAL SURVEY NO.	
SURVEYED PLOTTED AREAS CHECKED	
FINAL SURVEY NO.	
NOTE BOOK NO.	
TEMPLATE AREAS CHECKED	

FILE PATH = C:\Users\jshivez\Desktop\camp_en.tbl 20170919\CIRCLE\00-SHT-4CH-CV-RampEN\Cross_Section.dgn

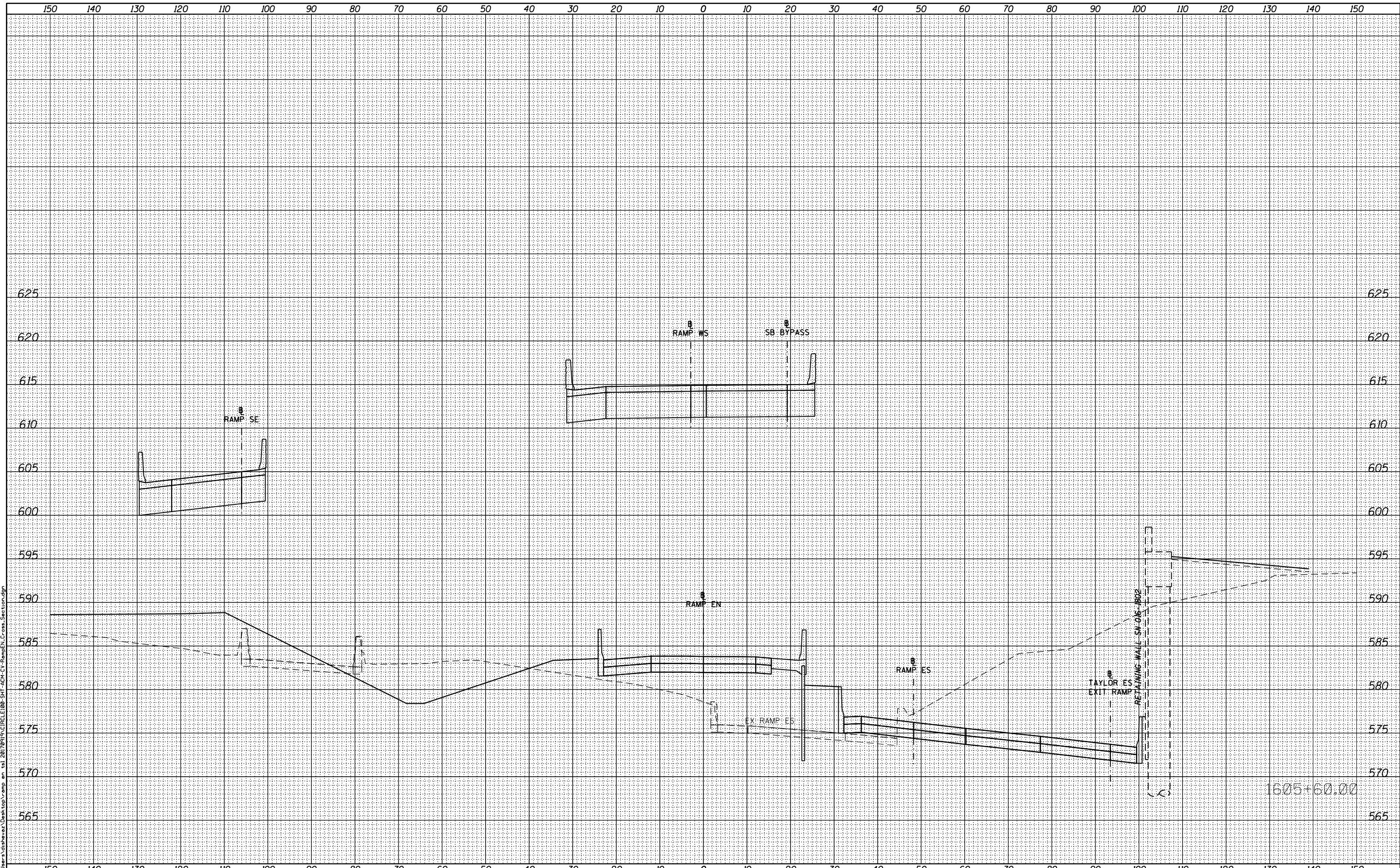

XS.SHEET	DESIGNED -	REVISED -
USER NAME = dishveoz	DRAWN -	REVISED -
PLOT SCALE = 20.0000' / in.	CHECKED -	REVISED -
PLOT DATE = 9/19/2017	DATE -	REVISED -

**STATE OF ILLINOIS
DEPARTMENT OF TRANSPORTATION**

CROSS SECTIONS - RAMP EN

SCALE: SHEET 9 OF 36 SHEETS STA. 1605+60.00 TO STA. 1605+60.00

F.A. RTE.	SECTION	COUNTY	TOTAL SHEETS	SHEET NO.
			36	
CONTRACT NO.				
ILLINOIS FED. AID PROJECT				

DATE	
BY	
ORIGINAL SURVEY NO.	
SURVEYED PLOTTED AREAS CHECKED	
FINAL SURVEY NO.	
NOTE BOOK NO.	
TEMPLATE AREAS CHECKED	

DATE	
BY	
ORIGINAL SURVEY NO.	
SURVEYED PLOTTED AREAS CHECKED	
FINAL SURVEY NO.	
NOTE BOOK NO.	
TEMPLATE AREAS CHECKED	

FILE PATH = C:\Users\jshivez\Desktop\camp_en.tbl 20170919\CIRCLE\00-SHT-4CH-CV-RampEN\Cross_Section.dgn

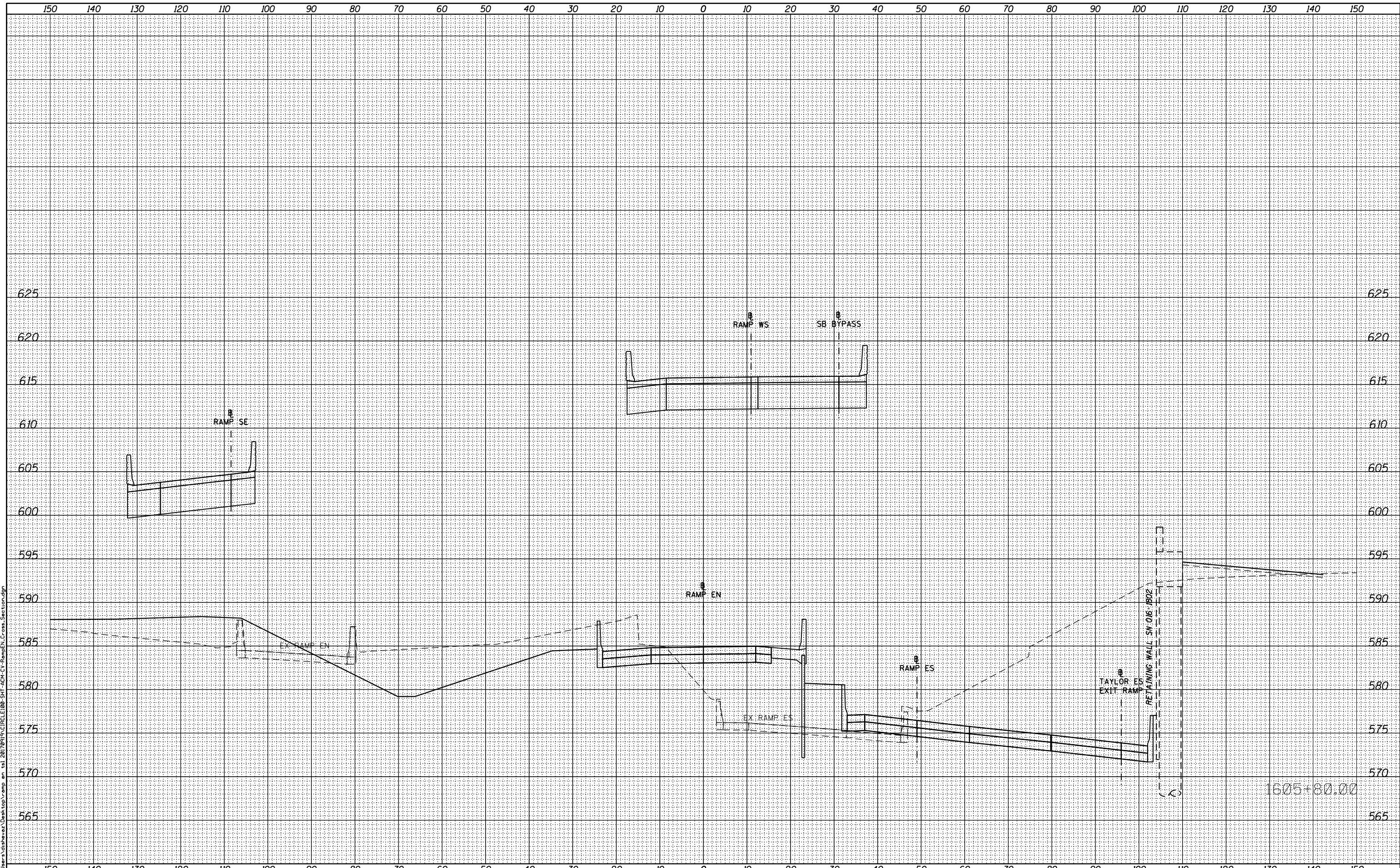

XS.SHEET	DESIGNED -	REVISED -
USER NAME = dishveoz	DRAWN -	REVISED -
PLOT SCALE = 20.0000' / in.	CHECKED -	REVISED -
PLOT DATE = 9/19/2017	DATE -	REVISED -

**STATE OF ILLINOIS
DEPARTMENT OF TRANSPORTATION**

CROSS SECTIONS - RAMP EN

SCALE: SHEET 10 OF 36 SHEETS STA. 1605+80.00 TO STA. 1605+80.00

F.A. RTE.	SECTION	COUNTY	TOTAL SHEETS	SHEET NO.
			36	
CONTRACT NO.				
ILLINOIS FED. AID PROJECT				

DATE	
BY	
ORIGINAL SURVEY NO.	
SURVEYED PLOTTED AREAS CHECKED	
FINAL SURVEY NO.	
NOTE BOOK NO.	
AREAS CHECKED	

DATE	
BY	
ORIGINAL SURVEY NO.	
SURVEYED PLOTTED AREAS CHECKED	
FINAL SURVEY NO.	
NOTE BOOK NO.	
AREAS CHECKED	

FILE PATH = C:\Users\dishevoz\Desktop\camp_en.tbl 20170919\CIRCLE\00-SHT-4CH-CV-RampEN\Cross_Section.dgn

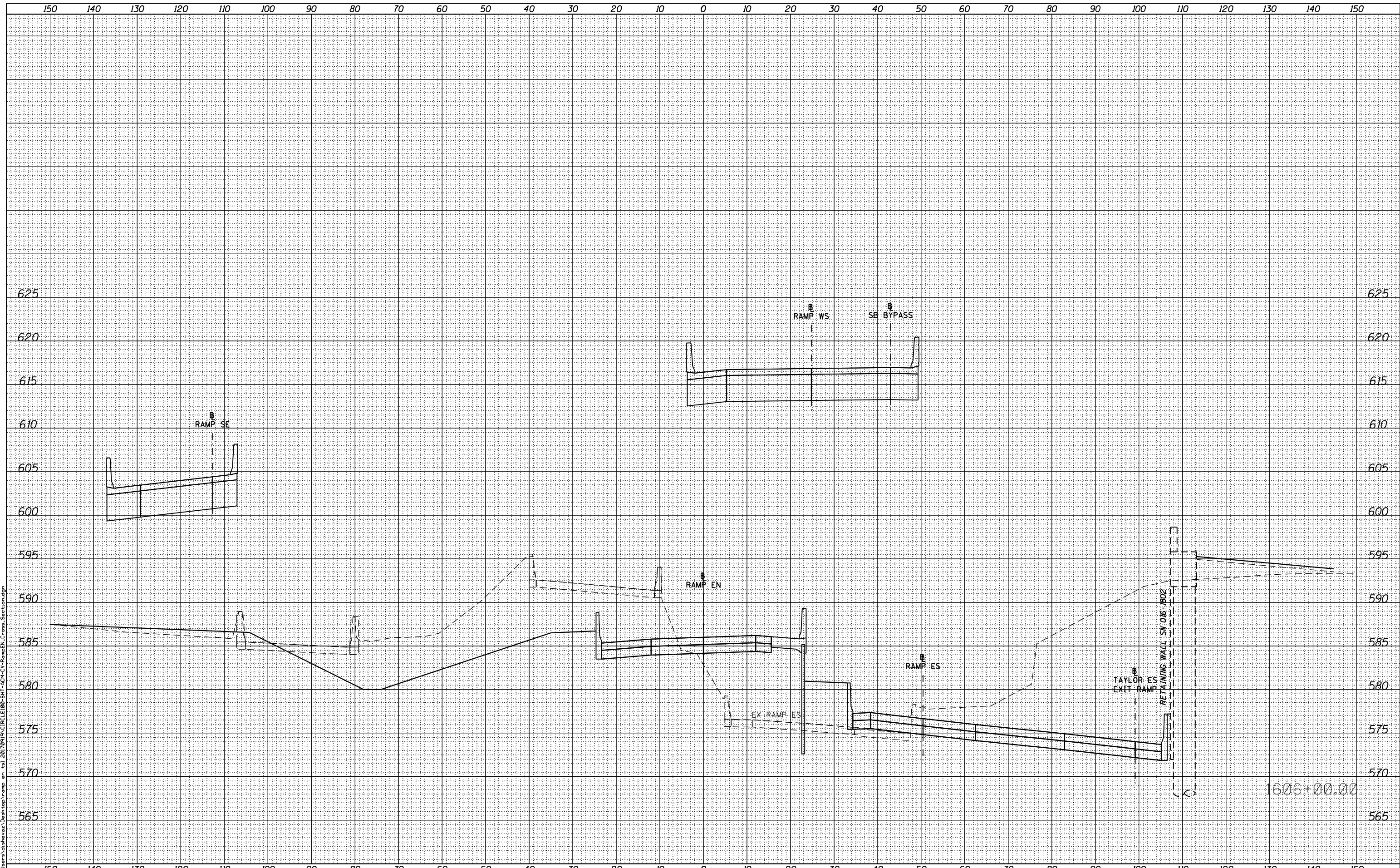

XS.SHEET	DESIGNED -	REVISED -
USER NAME = dishevoz	DRAWN -	REVISED -
PLOT SCALE = 20.0000' / in.	CHECKED -	REVISED -
PLOT DATE = 9/19/2017	DATE -	REVISED -

**STATE OF ILLINOIS
DEPARTMENT OF TRANSPORTATION**

CROSS SECTIONS - RAMP EN

SCALE: SHEET 11 OF 36 SHEETS STA. 1606+00.00 TO STA. 1606+00.00

F.A. RTE.	SECTION	COUNTY	TOTAL SHEETS	SHEET NO.
			36	
CONTRACT NO.				
ILLINOIS FED. AID PROJECT				

DATE	
BY	
ORIGINAL SURVEY NO.	
SURVEYED PLOTTED AREAS CHECKED	
NOTE BOOK	
TEMPLATE	
AREAS CHECKED	

DATE	
BY	
ORIGINAL SURVEY NO.	
SURVEYED PLOTTED AREAS CHECKED	
NOTE BOOK	
TEMPLATE	
AREAS CHECKED	

FILE PATH = C:\Users\jshivez\Desktop\camp_en.tbl 20170919\CIRCLE00-SHT-4CM-CV-RampEN.Cross.Section.dgn

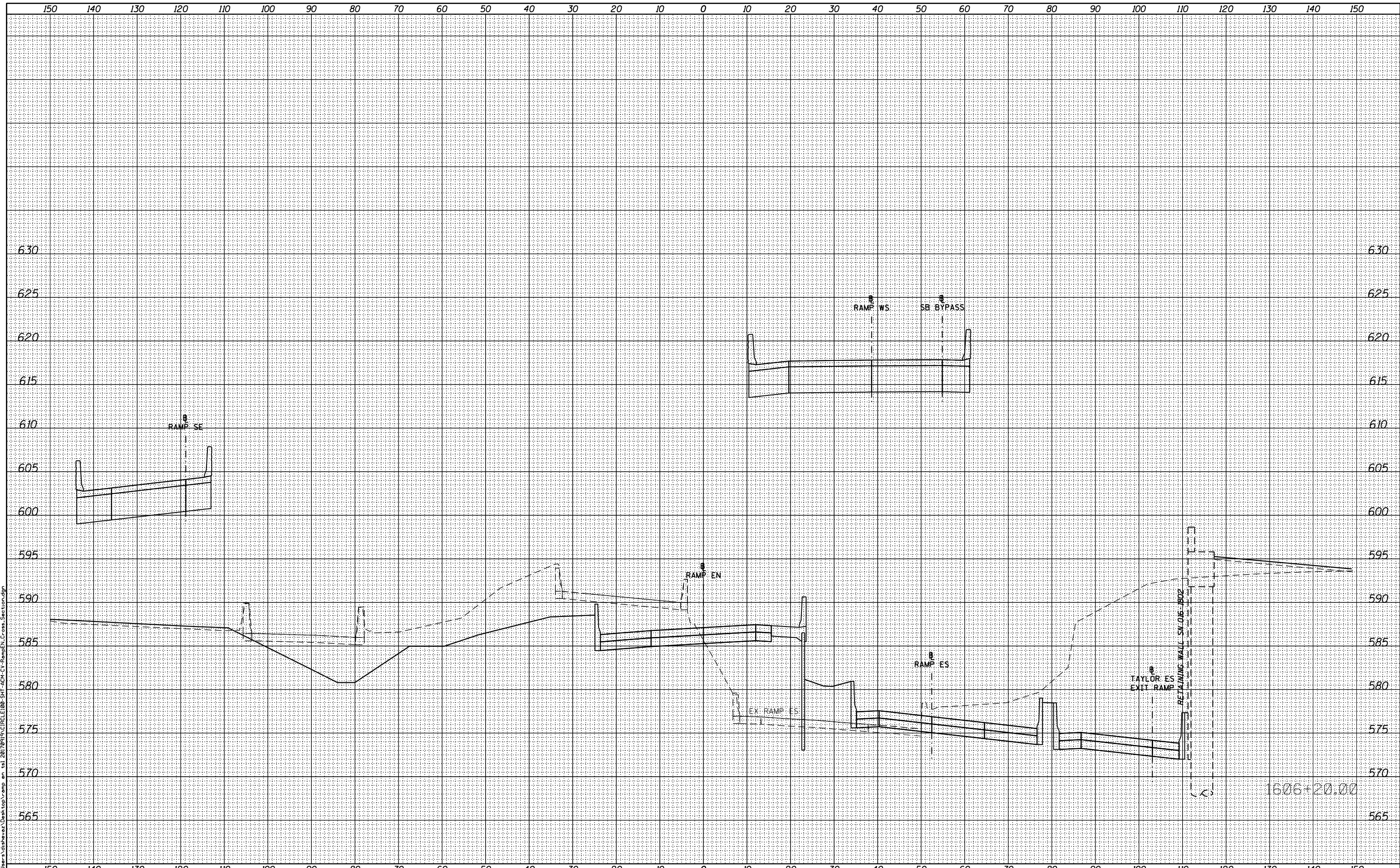

XS.SHEET	DESIGNED -	REVISED -
USER NAME = jshivez	DRAWN -	REVISED -
PLOT SCALE = 20.0000' / in.	CHECKED -	REVISED -
PLOT DATE = 9/19/2017	DATE -	REVISED -

**STATE OF ILLINOIS
DEPARTMENT OF TRANSPORTATION**

CROSS SECTIONS - RAMP EN

SCALE: SHEET 12 OF 36 SHEETS STA. 1606+20.00 TO STA. 1606+20.00

F.A. RTE.	SECTION	COUNTY	TOTAL SHEETS	SHEET NO.
			36	
CONTRACT NO.				
ILLINOIS FED. AID PROJECT				

BY	DATE
FINAL SURVEY	SURVEYED
NOTE BOOK	PLOTTED
NO.	TEMPLATE
	AREAS CHECKED
	AREAS CHECKED

BY	DATE
ORIGINAL SURVEY	SURVEYED
NOTE BOOK	PLOTTED
NO.	TEMPLATE
	AREAS CHECKED
	AREAS CHECKED

FILE PATH = C:\Users\jshivez\Desktop\comp_en.tbl 20170919\CIRCLE\00-3RT-4CH-CV-RampEN\Cross Section.dgn

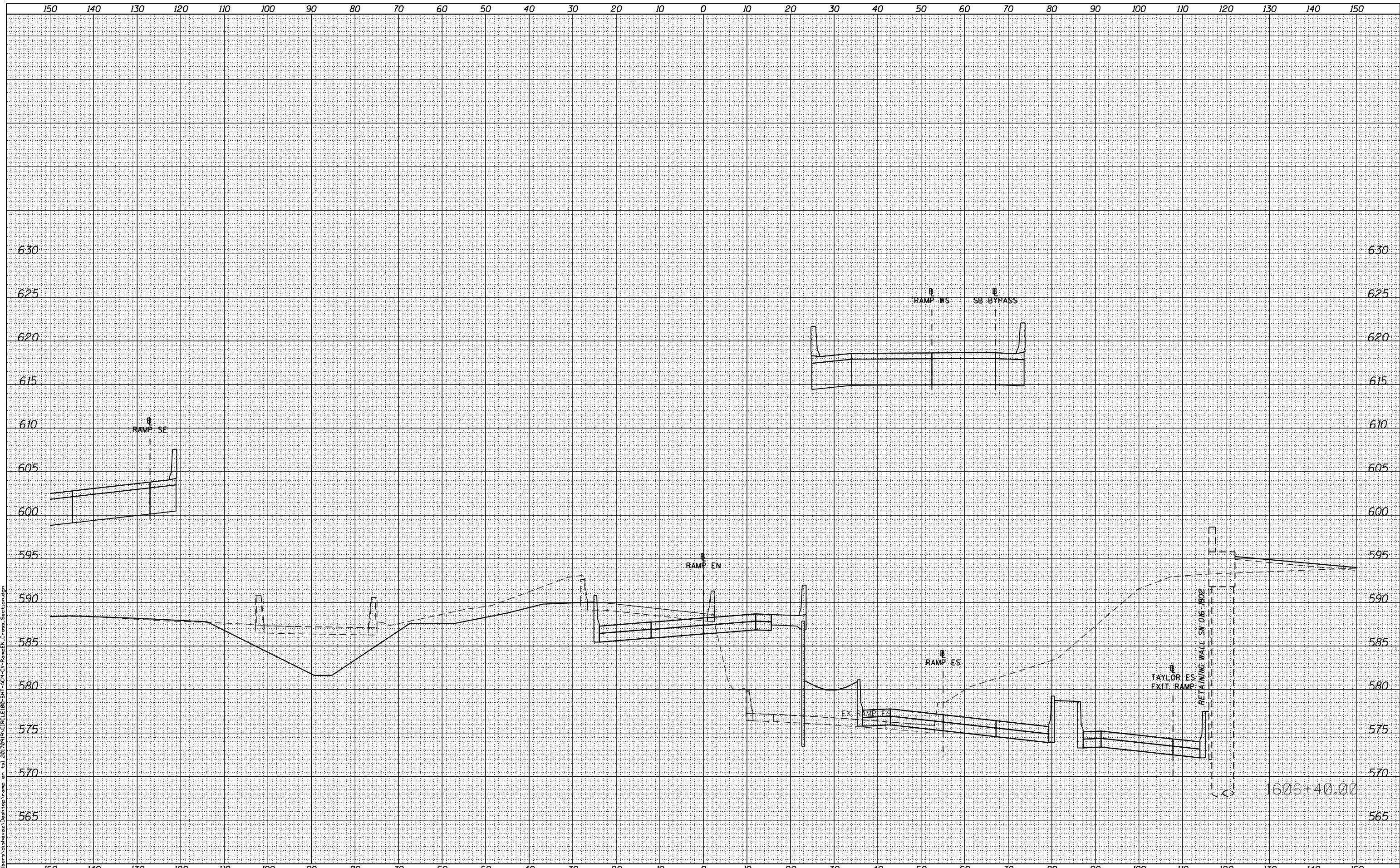

XS.SHEET	DESIGNED -	REVISED -
USER NAME = dshivez	DRAWN -	REVISED -
PLOT SCALE = 20.0000' / in.	CHECKED -	REVISED -
PLOT DATE = 9/19/2017	DATE -	REVISED -

**STATE OF ILLINOIS
DEPARTMENT OF TRANSPORTATION**

CROSS SECTIONS - RAMP EN

SCALE: SHEET 13 OF 36 SHEETS STA. 1606+40.00 TO STA. 1606+40.00

F.A. RTE.	SECTION	COUNTY	TOTAL SHEETS	SHEET NO.
			36	
				CONTRACT NO.
ILLINOIS FED. AID PROJECT				

DATE	
BY	
FINISHED SURVEY	
PLOTTED TEMPLATE	
AREAS CHECKED	
NO.	

DATE	
BY	
ORIGINAL SURVEY	
PLOTTED TEMPLATE	
AREAS CHECKED	
NO.	

FILE PATH = C:\Users\dishevo\Desktop\comp_en.tbl\20170913\CIRCLE\00-SHT-4CM-CV-RampEN\Cross_Section.dgn

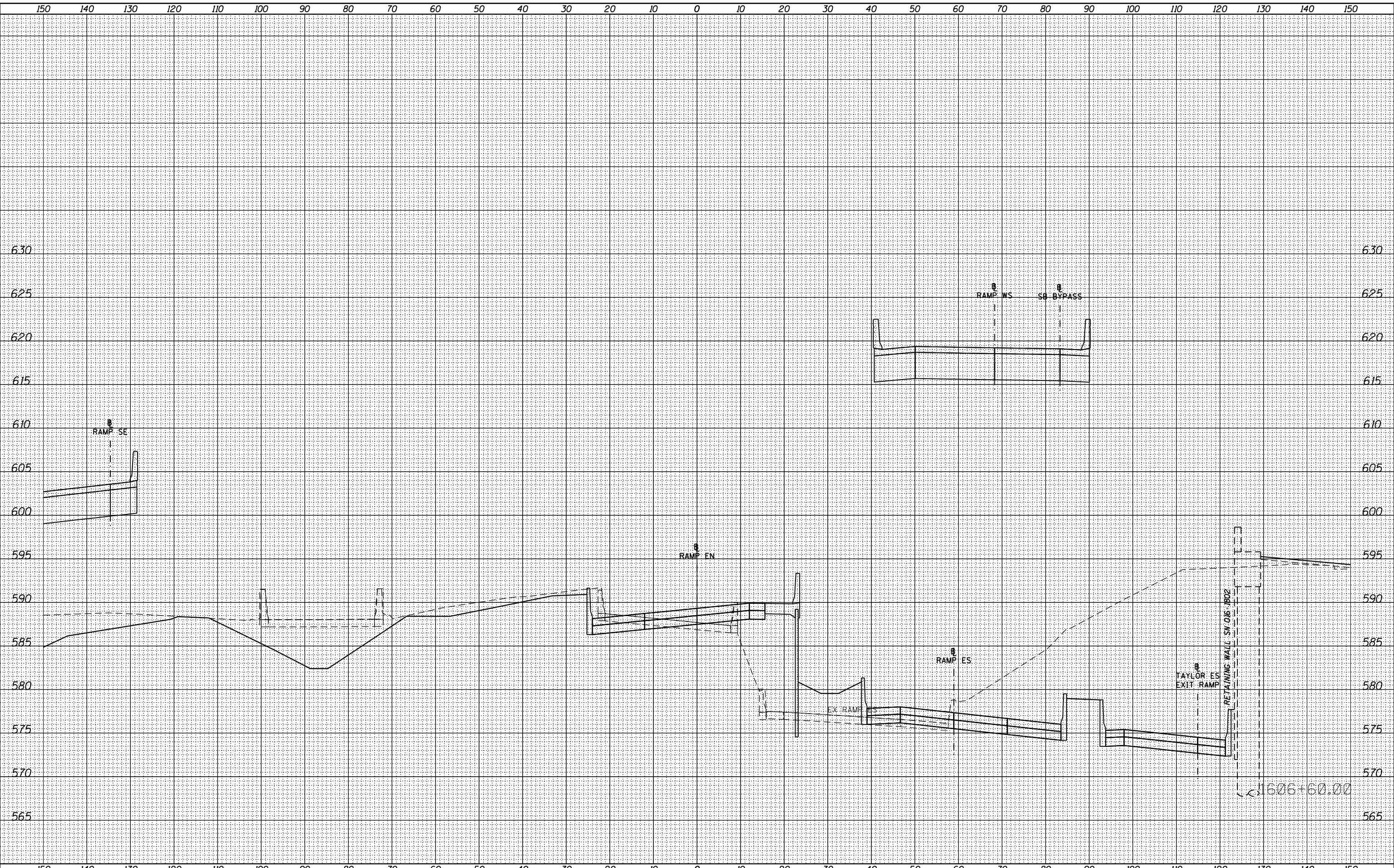

XS.SHEET
 USER NAME = dishevo
 PLOT SCALE = 20.0000' / in.
 PLOT DATE = 9/19/2017

DESIGNED -
 DRAWN -
 CHECKED -
 DATE -

REVISED -
 REVISED -
 REVISED -
 REVISED -

STATE OF ILLINOIS
 DEPARTMENT OF TRANSPORTATION

CROSS SECTIONS - RAMP EN

SCALE: SHEET 14 OF 36 SHEETS STA. 1606+60.00 TO STA. 1606+60.00

F.A. RTE.	SECTION	COUNTY	TOTAL SHEETS	SHEET NO.
			36	
			CONTRACT NO.	
ILLINOIS FED. AID PROJECT				

DATE	
BY	
ORIGINAL SURVEY NO.	
SURVEYED PLOTTED AREAS CHECKED	
NOTE BOOK NO.	
TEMPLATE AREAS CHECKED	

DATE	
BY	
ORIGINAL SURVEY NO.	
SURVEYED PLOTTED AREAS CHECKED	
NOTE BOOK NO.	
TEMPLATE AREAS CHECKED	

FILE PATH = C:\Users\jshivez\Desktop\camp_en.tbl 20170919\CIRCLE00-SHT-4CH-CV-RampEN\Cross_Section.dgn

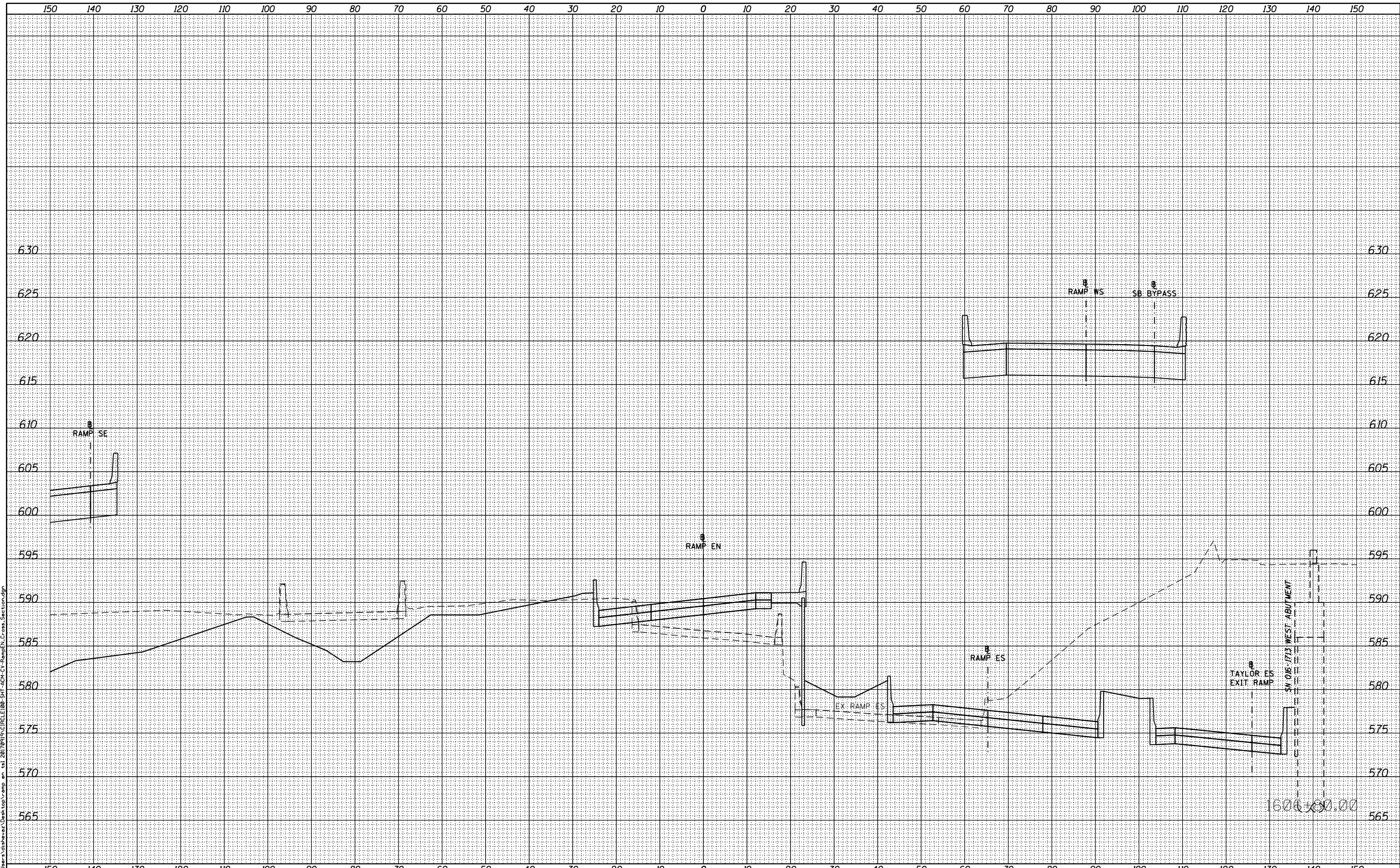

XS.SHEET	DESIGNED -	REVISED -
USER NAME = jshivez	DRAWN -	REVISED -
PLOT SCALE = 20.0000' / in.	CHECKED -	REVISED -
PLOT DATE = 9/19/2017	DATE -	REVISED -

**STATE OF ILLINOIS
DEPARTMENT OF TRANSPORTATION**

CROSS SECTIONS - RAMP EN

SCALE: SHEET 15 OF 36 SHEETS STA. 1606+80.00 TO STA. 1606+80.00

F.A. RTE.	SECTION	COUNTY	TOTAL SHEETS	SHEET NO.
			36	
CONTRACT NO.				
ILLINOIS FED. AID PROJECT				

DATE	
BY	
ORIGINAL SURVEY NO.	
SURVEYED PLOTTED AREAS CHECKED	
FINAL SURVEY NO.	
NOTE BOOK NO.	
TEMPLATE AREAS CHECKED	

DATE	
BY	
ORIGINAL SURVEY NO.	
SURVEYED PLOTTED AREAS CHECKED	
FINAL SURVEY NO.	
NOTE BOOK NO.	
TEMPLATE AREAS CHECKED	

FILE PATH = C:\Users\jshivez\Desktop\camp_en.tbl 20170919\CIRCLE00-SHT-4CH-CV-RampEN\Cross_Section.dgn

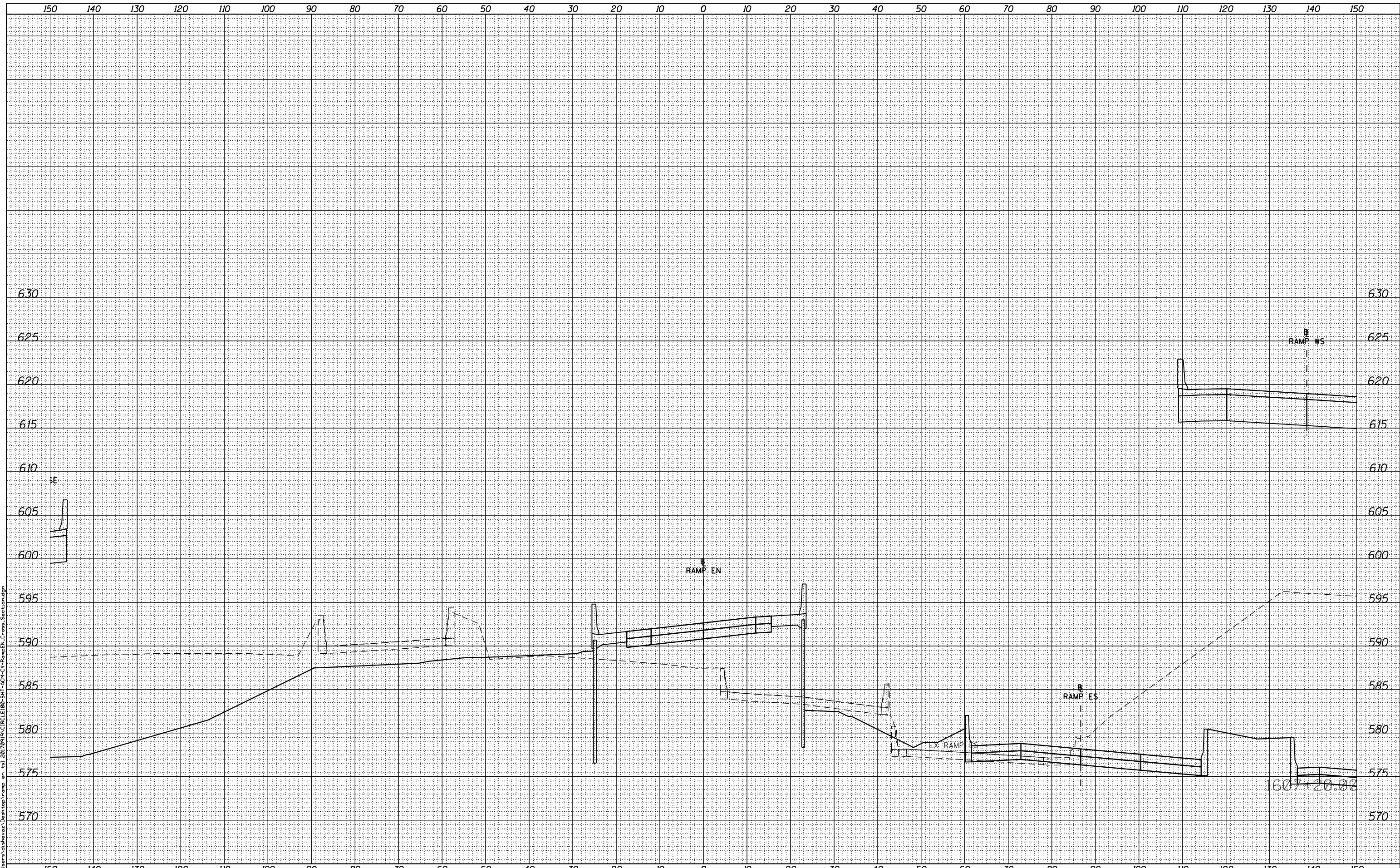

XS.SHEET	DESIGNED -	REVISED -
USER NAME = jshivez	DRAWN -	REVISED -
PLOT SCALE = 20.0000' / in.	CHECKED -	REVISED -
PLOT DATE = 9/19/2017	DATE -	REVISED -

**STATE OF ILLINOIS
DEPARTMENT OF TRANSPORTATION**

SCALE:	SHEET 17 OF 36 SHEETS	STA. 1607+20.00 TO STA. 1607+20.00
--------	-----------------------	------------------------------------

F.A. RTE.	SECTION	COUNTY	TOTAL SHEETS	SHEET NO.
			36	
CONTRACT NO.			ILLINOIS FED. AID PROJECT	

DATE	
BY	
FINAL SURVEY NO.	
SURVEYED PLOTTED AREAS CHECKED	
NOTE BOOK	
TEMPLATE	
AREAS CHECKED	

DATE	
BY	
ORIGINAL SURVEY NO.	
SURVEYED PLOTTED AREAS CHECKED	
NOTE BOOK	
TEMPLATE	
AREAS CHECKED	

FILE PATH = C:\Users\jshiveoz\Desktop\camp_en.tbl 20170919\CIRCLE100-317-42M-CV-RampEN\Cross_Section.dgn

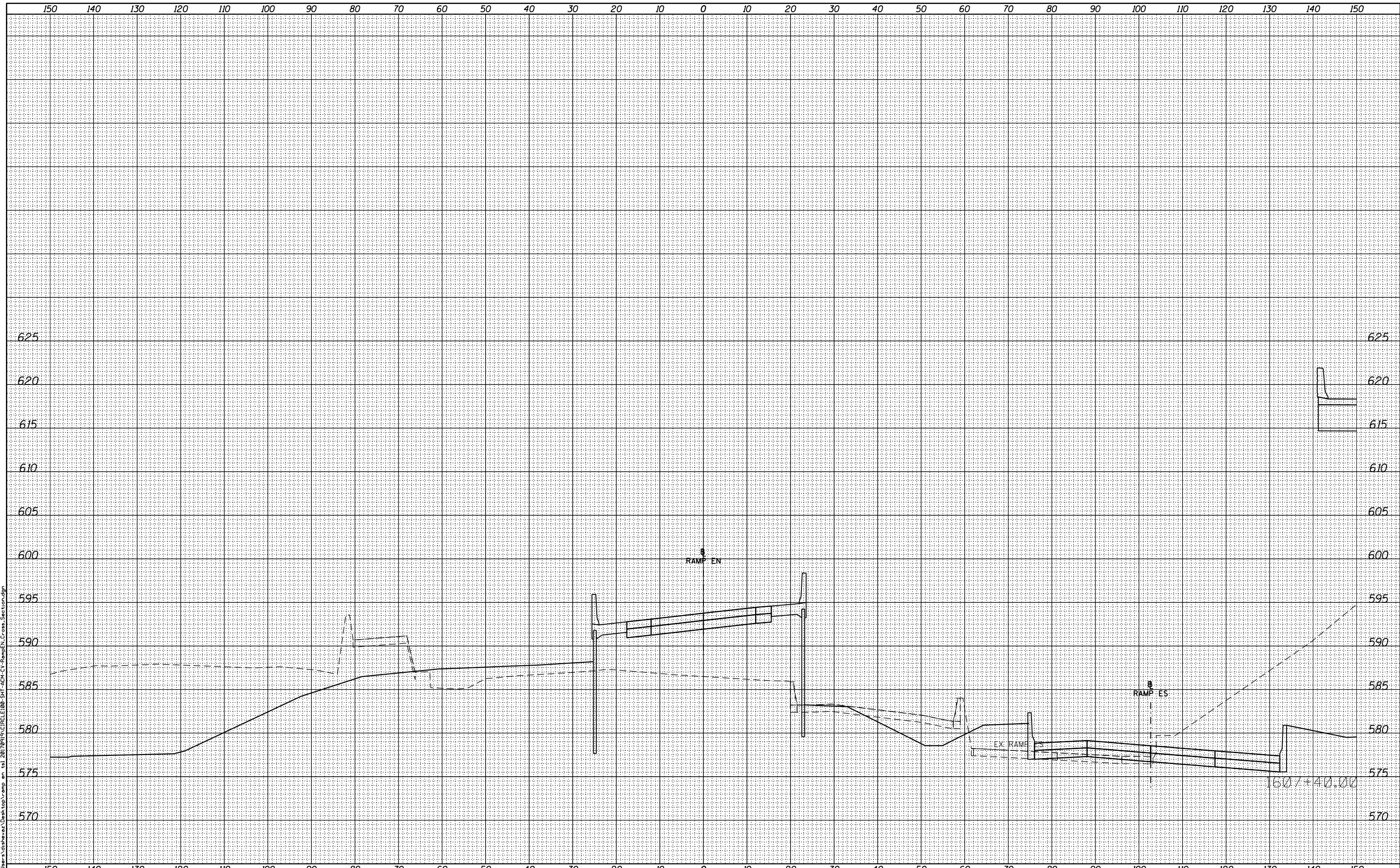

XS.SHEET	DESIGNED -	REVISED -
USER NAME = jshiveoz	DRAWN -	REVISED -
PLOT SCALE = 20.0000' / in.	CHECKED -	REVISED -
PLOT DATE = 9/19/2017	DATE -	REVISED -

**STATE OF ILLINOIS
DEPARTMENT OF TRANSPORTATION**

CROSS SECTIONS - RAMP EN
SCALE: SHEET 18 OF 36 SHEETS STA. 1607+40.00 TO STA. 1607+40.00

F.A. RTE.	SECTION	COUNTY	TOTAL SHEETS	SHEET NO.
			36	
CONTRACT NO.				
ILLINOIS FED. AID PROJECT				

DATE	
BY	
FINAL SURVEY NO.	
SURVEYED PLOTTED AREAS CHECKED	
NOTE BOOK NO.	
TEMPLATE AREAS CHECKED	

DATE	
BY	
ORIGINAL SURVEY NO.	
SURVEYED PLOTTED AREAS CHECKED	
NOTE BOOK NO.	
TEMPLATE AREAS CHECKED	

FILE PATH = C:\Users\dishevoz\Desktop\camp_en.tbl 20170919\CIRCLE00-SHT-4CM-CV-RampEN\Cross_Section.dgn

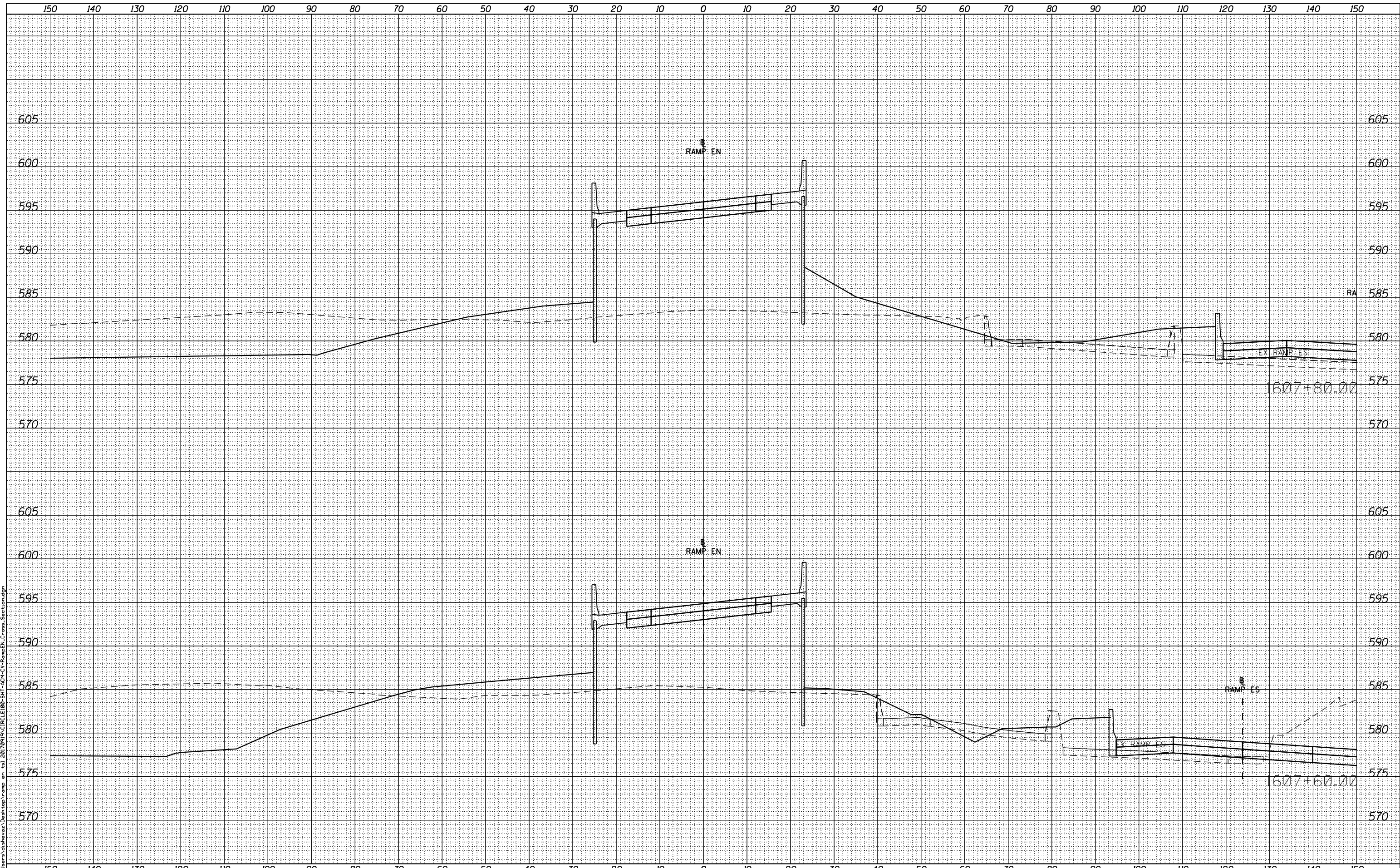

XS.SHEET	DESIGNED -	REVISED -
USER NAME = dishevoz	DRAWN -	REVISED -
PLOT SCALE = 20.0000' / in.	CHECKED -	REVISED -
PLOT DATE = 9/19/2017	DATE -	REVISED -

**STATE OF ILLINOIS
DEPARTMENT OF TRANSPORTATION**

CROSS SECTIONS - RAMP EN

SCALE: SHEET 19 OF 36 SHEETS STA. 1607+60.00 TO STA. 1607+80.00

F.A. RTE.	SECTION	COUNTY	TOTAL SHEETS	SHEET NO.
			36	
CONTRACT NO.				
ILLINOIS FED. AID PROJECT				

DATE	
BY	
FINAL SURVEY	SURVEYED
NOTE BOOK	PLOTTED
NO.	TEMPLATE
	AREAS CHECKED

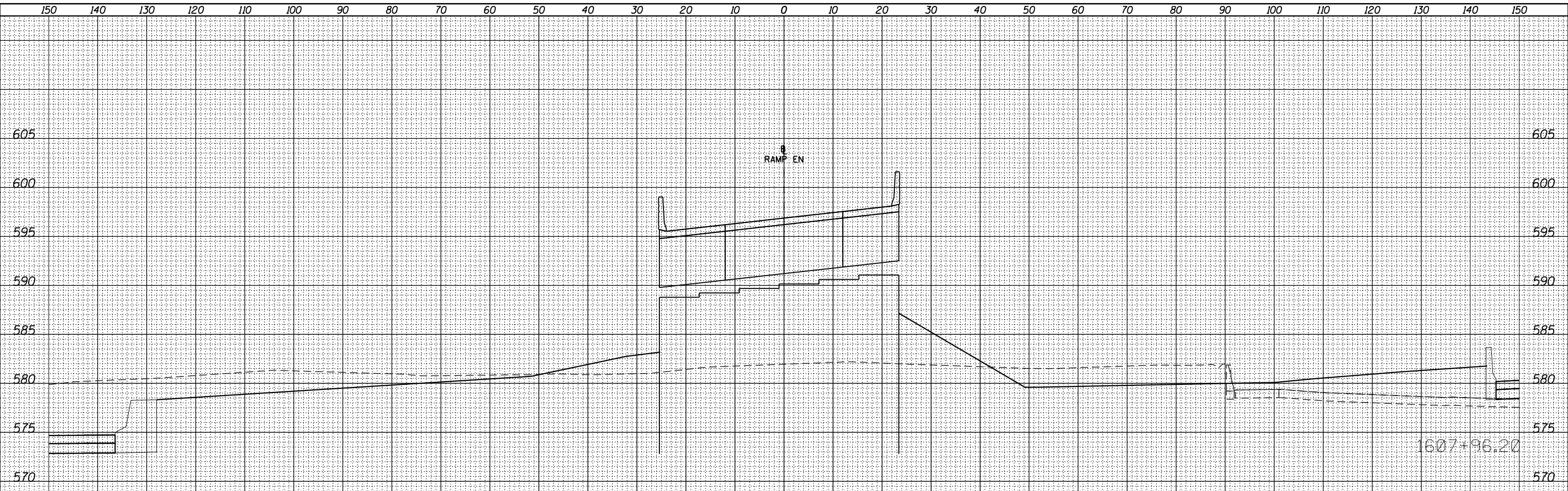

DATE	
BY	
ORIGINAL SURVEY	SURVEYED
NOTE BOOK	PLOTTED
NO.	TEMPLATE
	AREAS CHECKED

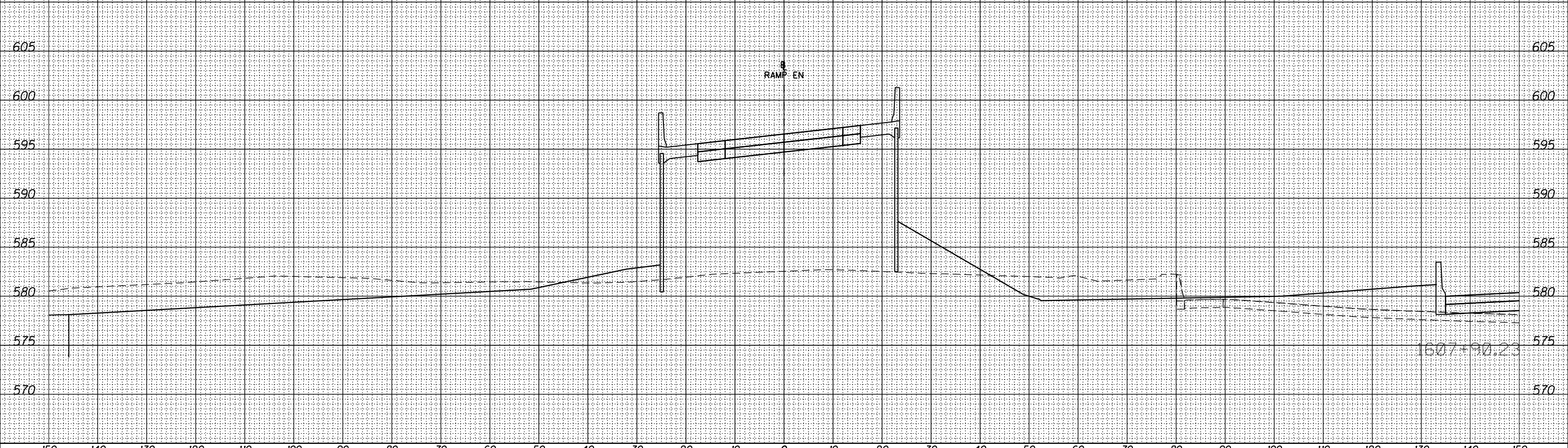

FILE PATH = C:\Users\jshveoz\Desktop\camp_en.tbl 20170919\CIRCLE00-SIT-4CM-CV-RampEN.Cross.Section.dgn



XS.SHEET	DESIGNED -	REVISED -
USER NAME = dishevoz	DRAWN -	REVISED -
PLOT SCALE = 20.0000' / in.	CHECKED -	REVISED -
PLOT DATE = 9/19/2017	DATE -	REVISED -

**STATE OF ILLINOIS
DEPARTMENT OF TRANSPORTATION**

CROSS SECTIONS - RAMP EN

SCALE: SHEET 20 OF 36 SHEETS STA. 1607+90.23 TO STA. 1607+96.20

F.A. RTE.	SECTION	COUNTY	TOTAL SHEETS	SHEET NO.
			36	
CONTRACT NO.				
ILLINOIS FED. AID PROJECT				