

ROUTE NO.	SECTION	COUNTY	TOTAL SHEETS	SHEET NO.
F.A.P. 310 U.S. 67	(40BY)BR. (41-A)BR-1	McDonough	66	26
FED. ROAD DIST. NO. 1		FED. AID PROJECT-		

SHEET NO. 9
14 SHEETS

Contract #68677

NOTES

Inserts for $\frac{3}{4}$ " ϕ threaded dowel rods, when specified, are to be two strut, coil type for interior beams and single coil, flared loop type for exterior beams.

Prestressing steel shall be uncoated high strength, low relaxation 7-wire strand, Grade 270.

The nominal diameter shall be $\frac{1}{2}$ " and the nominal cross-sectional area shall be 0.153 sq. in.

Non-prestressing steel shall conform to AASHTO designation M-31 or M 322, Grade 60.

A minimum $2\frac{1}{2}$ " ϕ lifting pin shall be used to engage the lifting loops during handling.

Reinforcement bars designated (E) shall be epoxy coated.

The bottom plates and studs shall be galvanized according to AASHTO M111 and ASTM A385.

Threaded rods shall be ASTM F 1554 Grade 55.

The cut strands at each beam end shall be given two coats of zinc dust spray or paint meeting the requirements of ASTM A 780. The zinc dust spray or paint shall be applied before corrosion appears and allowed to dry according to the manufacturer's specifications prior to another coat of zinc. A concrete sealer meeting the requirements of Section 587 of the Standard Specifications shall be applied to all portions of the I-beam or Bulb-T beam, except the top surface of the top flange and the bottom surface of the bottom flange, starting at each beam end and extending out a distance of 54". The sealer shall be applied after visible crack growth has subsided. This work shall be performed by the producer and included with the cost of the beam.

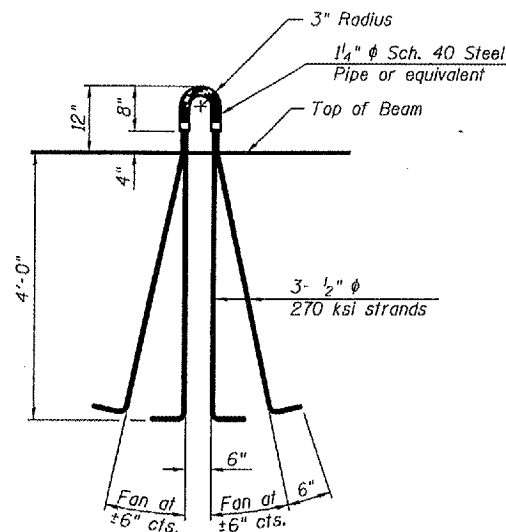

LIFTING LOOP DETAIL

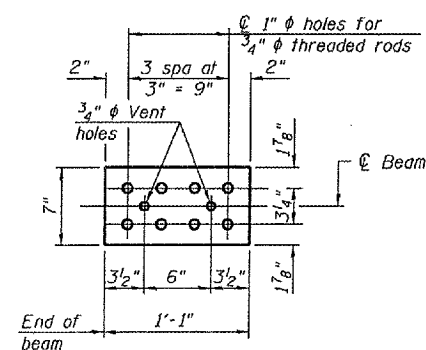

TOP PLATE

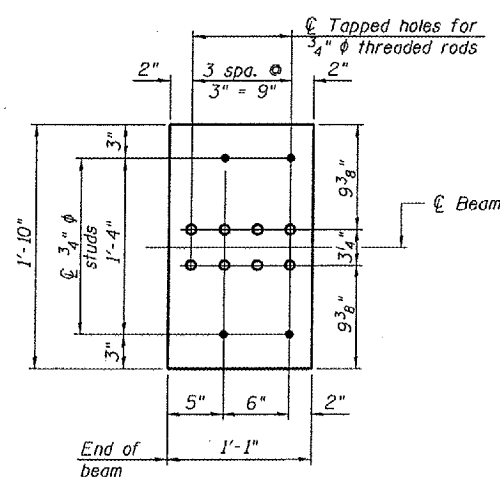

BOTTOM PLATE

See bearing details for pintle hole locations when required.

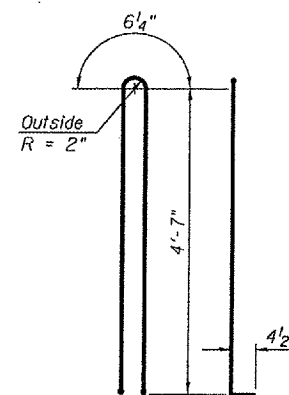

BAR G1

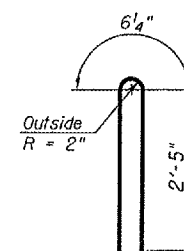

BAR G2

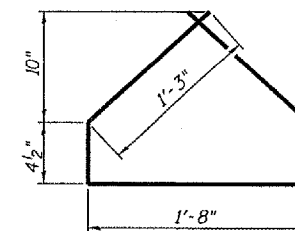

BAR G4

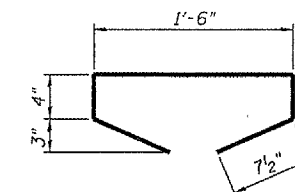

BAR G5

BILL OF MATERIAL

Item	Unit	Total
Furnishing and Erecting Precast Prestressed Concrete I-Beams, 54"	Ft.	673.8

PRESTRESSED BEAM DETAILS
F.A.P. 310, SECTION (41A)BR-1
U.S. ROUTE 67 OVER GRINDSTONE CREEK
MCDONOUGH COUNTY
STA. 454+20 (S.N. 055-0049)

WHA # 1050D03