

EXISTING HORIZONTAL & VERTICAL CONTROL

F.A.P. RTE.	SECTION	COUNTY	TOTAL SHEET NO.
303	I29K	WINNEBAGO	585 62
STA.		TO STA.	
FED. ROAD DIST. NO.		ILLINOIS FED. AID PROJECT	

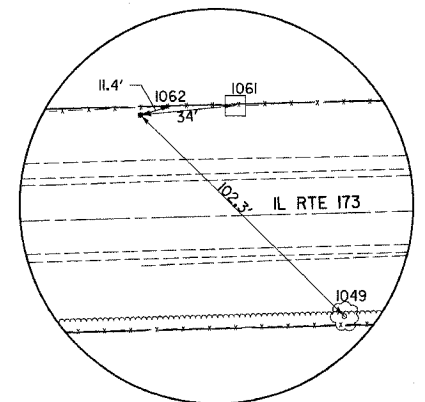

Dist. 2 Network Monument
No. 65723046

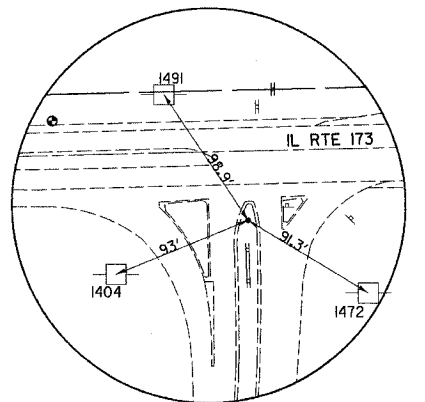

Dist. 2 Network Monument
No. 65723045

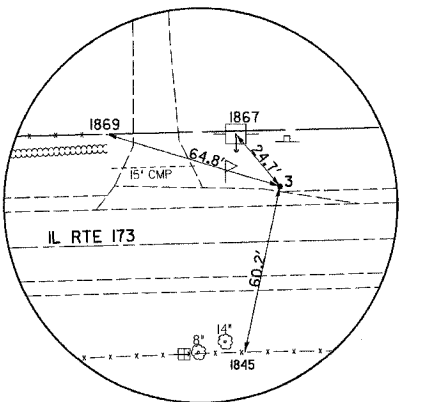

Horizontal Control No. 3
5/8" Iron Pin

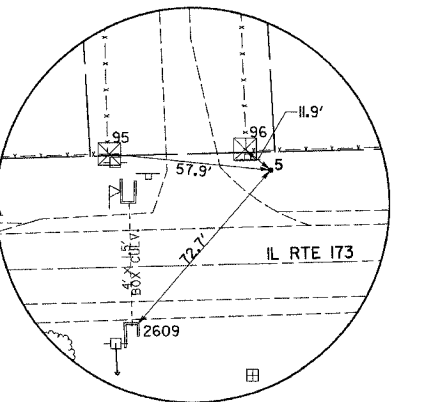

Horizontal Control No. 5
5/8" Iron Pin

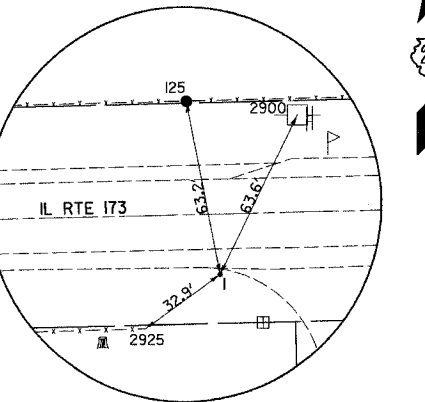

Horizontal Control No. 1
5/8" Iron Pin

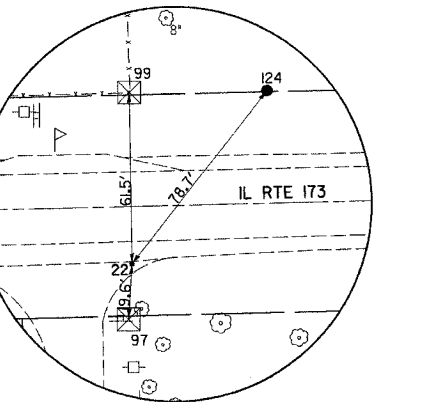

Horizontal Control No. 22
3/4" Iron Pin

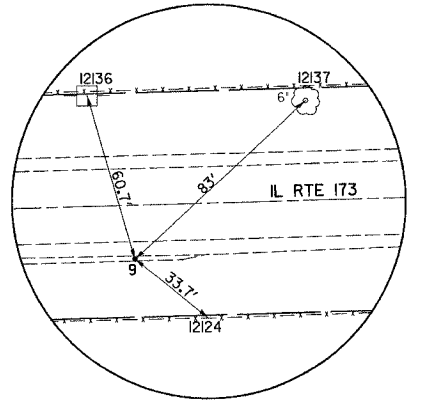

Horizontal Control No. 9
5/8" Iron Pin

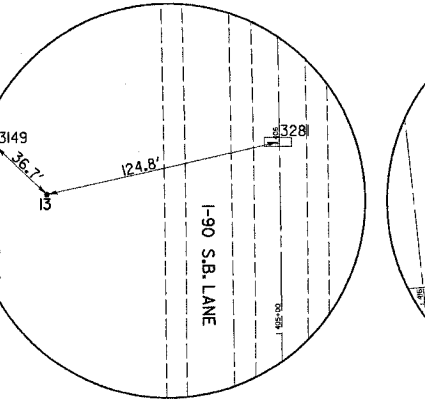

Horizontal Control No. 13
3/4" Iron Pin

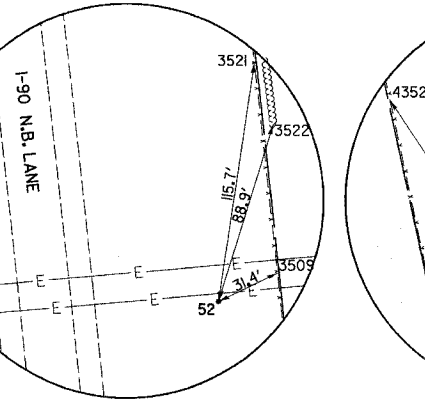

Horizontal Control No. 52
5/8" Iron Pin

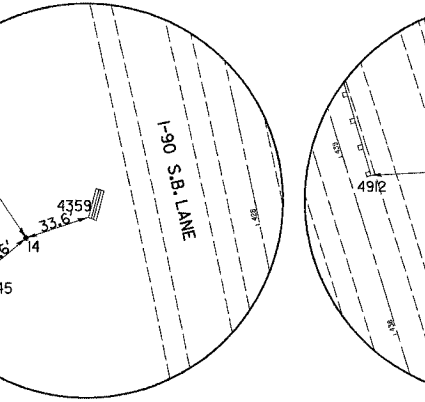

Horizontal Control No. 14
3/4" Iron Pin

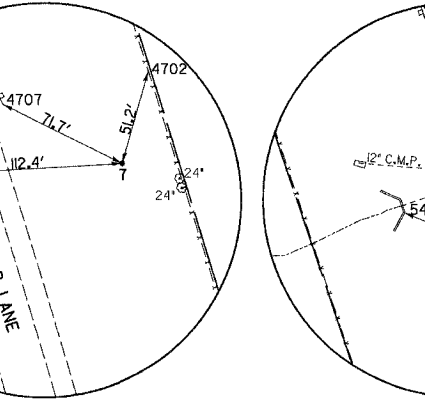

Horizontal Control No. 7
Iron Pin

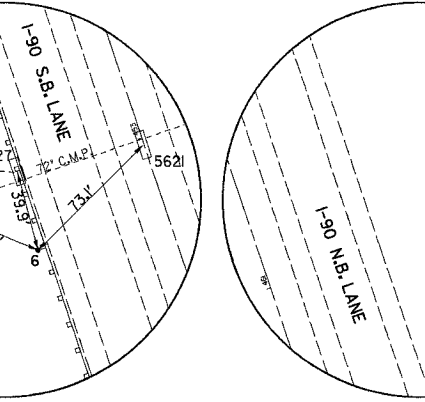

Horizontal Control No. 6
3/4" Iron Pin

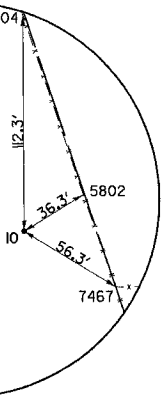

Horizontal Control No. 10
Iron Pin

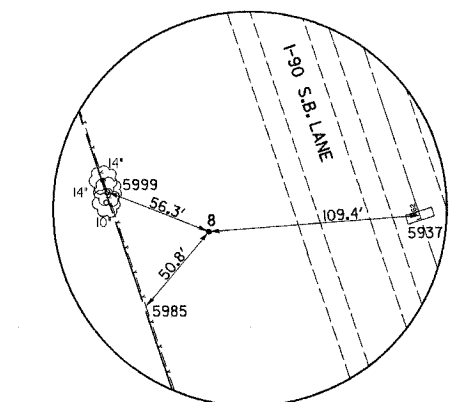

Horizontal Control No. 8
Iron Pin

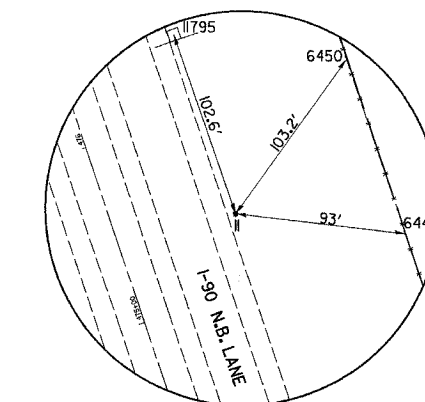

Horizontal Control No. 11
3/4" Iron Pin

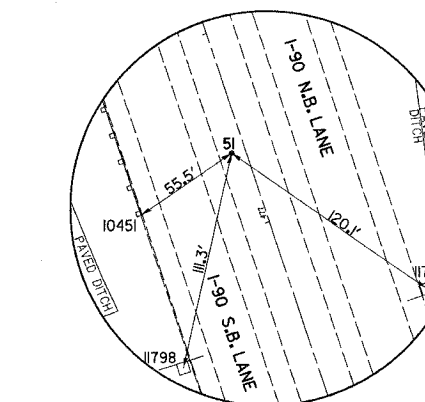

Horizontal Control No. 51
5/8" Iron Pin

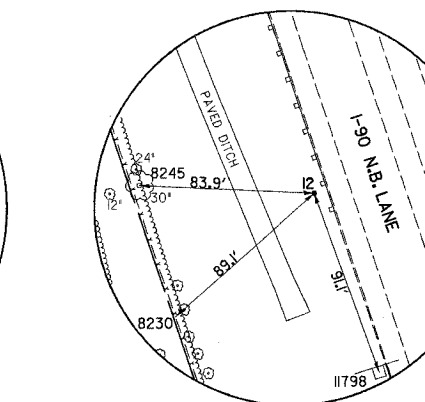

Horizontal Control No. 12
Iron Pin

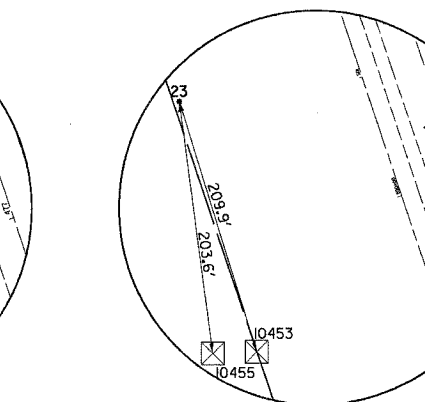

Horizontal Control No. 23
3/4" Iron Pin

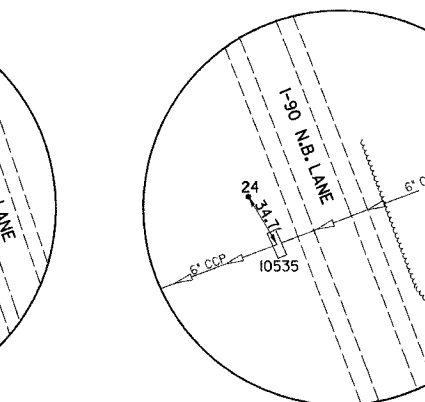

Horizontal Control No. 24
3/4" Iron Pin

PLOT DATE =
FILE NAME =
PLOT SCALE =
REFERENCE =

REVISIONS	
NAME	DATE

ILLINOIS DEPARTMENT OF TRANSPORTATION
HORIZONTAL & VERTICAL CONTROL
SCALE: VERT. 1" = 40'
HORIZ. 1" = 100'
DATE: SEPTEMBER 14, 2005
DRAWN BY
CHECKED BY

HORIZONTAL & VERTICAL CONTROL