

Existing #8n bars to be cleaned and incorporated into the new construction. Cost included with Concrete Removal (typ.)

Pier 3 S.B. WEST FACE

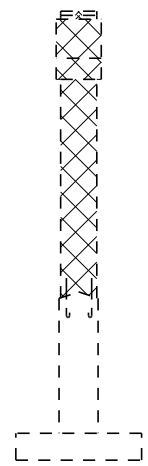

Pier 3 S.B. SOUTH END

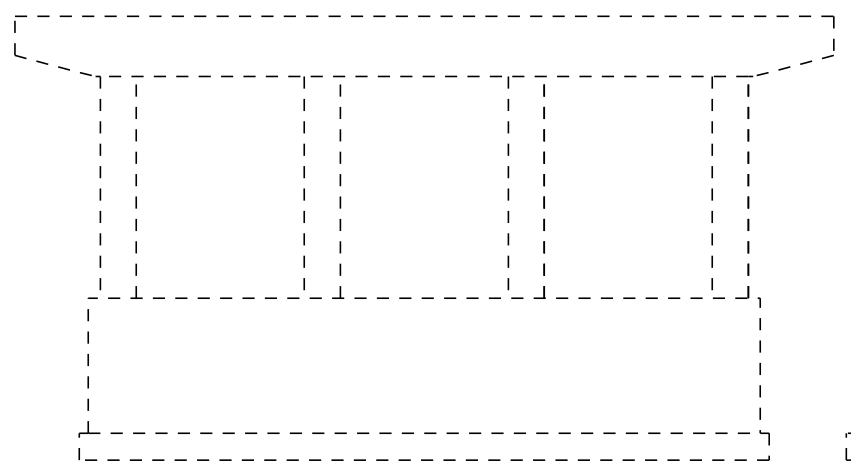

Pier 4 S.B. WEST FACE

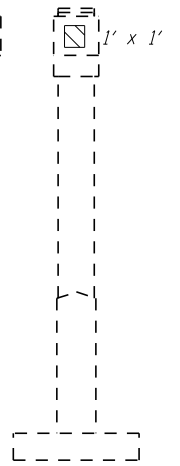

Pier 4 S.B. SOUTH END

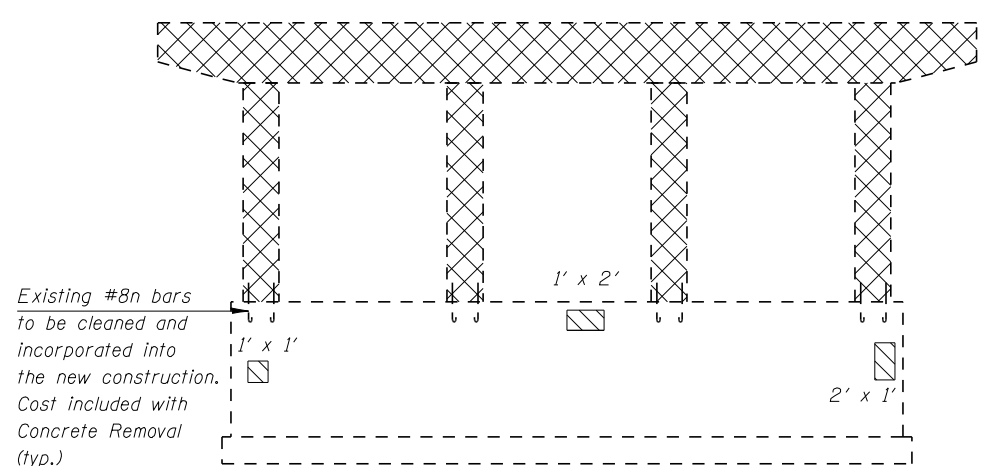

Existing #8n bars to be cleaned and incorporated into the new construction. Cost included with Concrete Removal (typ.)

Pier 3 S.B. EAST FACE

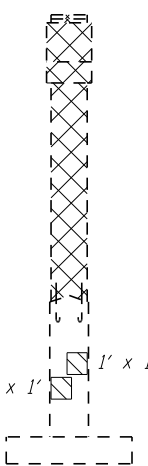

Pier 3 S.B. NORTH END

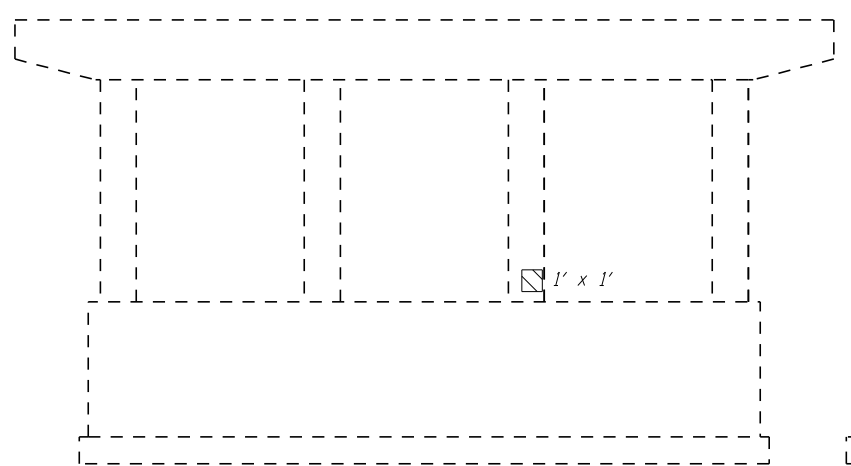

Pier 4 S.B. EAST FACE

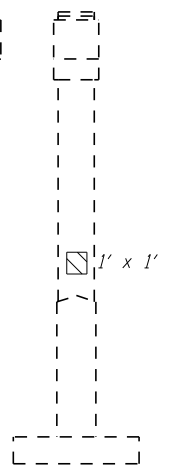

Pier 4 S.B. NORTH END

LEGEND

- Denotes Structural Repair of Concrete (Depth Equal to or Less Than 5")
- Denotes Concrete Removal

NOTES

1. Existing Reinforcement which extends into the removal areas is to be preserved, cleaned and incorporated into the new construction in accordance with Section 501.03 of the Standard Specifications. Cost included in CONCRETE REMOVAL.
2. Existing Girders to be supported during the removal and reconstruction of Pier 3. See Special Provision for Temporary Support System.

BILL OF MATERIAL

Item	Unit	Total
Structural Repair of Concrete (Depth Equal to or Less Than 5")	Sq. Ft.	24
Concrete Removal	Cu. Yd.	65.9
Temporary Support System	L. Sum	0.5