

CROSS SECTION
(25' SPAN)

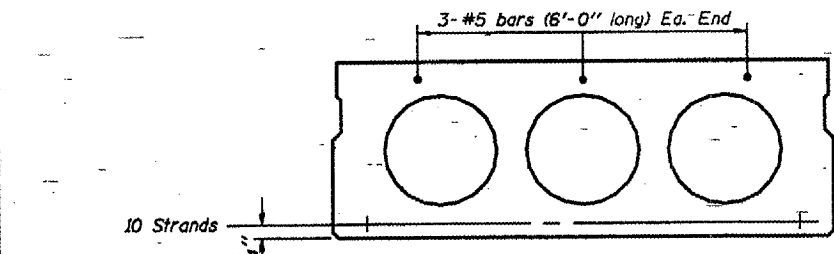

CROSS SECTION
(30' SPAN)

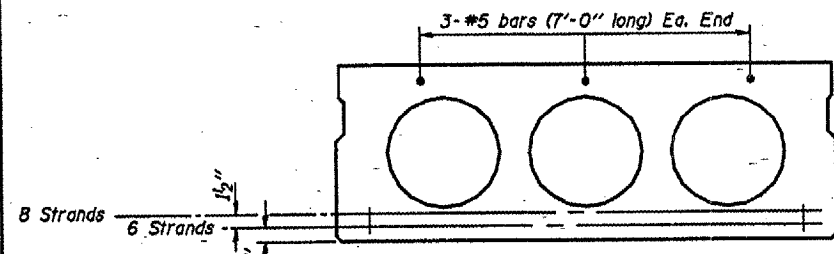

CROSS SECTION
(35' SPAN)

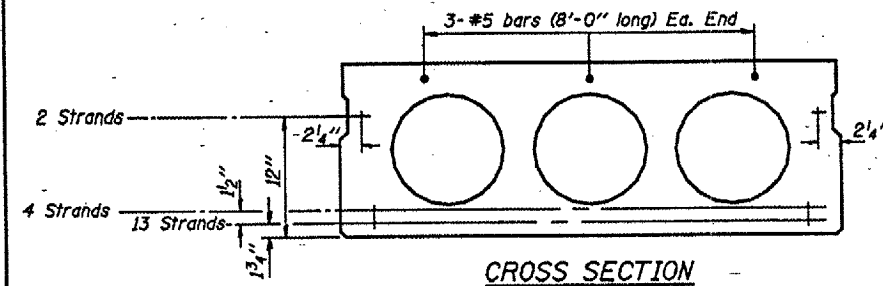

CROSS SECTION
(40' SPAN)

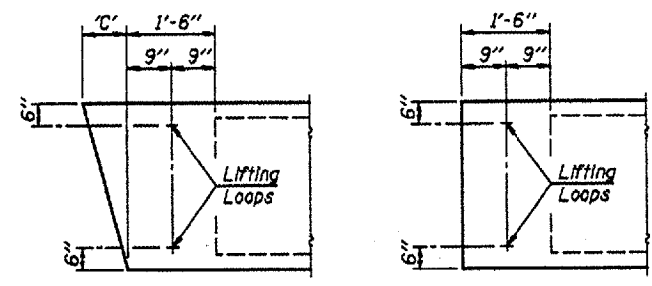

END BLOCK DETAILS

Each beam shall have four Lifting Loops, two at each end of beam cast in locations shown above. Loops shall be burned off after beams have been erected.

DIMENSION 'C'

Skew Angle 'D'	0°	5°	10°	15°	20°	25°	30°
Dimension 'C' (Inches)	0	4 1/4	8 1/2	12 1/8	17 1/2	22 3/8	27 3/4

*** TRANSVERSE STRAND PLACEMENT GUIDELINES**

1. Place strands symmetrically about centerline of beam.
2. The minimum distance from center to center of strands in all directions shall be 2".
3. The minimum clearance from strand to dowel hole shall be 1/2".
4. The minimum clearance from strand to void shall be 1/2".

Vertical placement of strands shall not be adjusted to satisfy the above guidelines.

NOTES

1. Prestressing steel shall be uncoated high strength, low relaxation 7-wire strand, Grade 270.
2. The nominal diameter shall be 1/2" and the nominal cross-sectional area shall be 0.153 square inches.
3. Reinforcement bars shall conform to the requirements of AASHTO M-31 or M-322, Grade 60.
4. Roll Post anchor devices shall be cast into outside beam as elsewhere specified.
5. When a Waterproofing Membrane System is specified, the top surface of the beams shall be screeded with a straightedge and finished with a hand float. The finished surface shall be free of depressions or high spots with sharp corners and the top edge of keys shall be rounded or chamfered a minimum of 1/4".
6. Keyway surfaces shall be cleaned to remove form oil or other bond breaking material prior to shipment of the beams. Cleaning shall be done by sandblasting the keyway areas between the top of the beam and the bottom edge of the key.

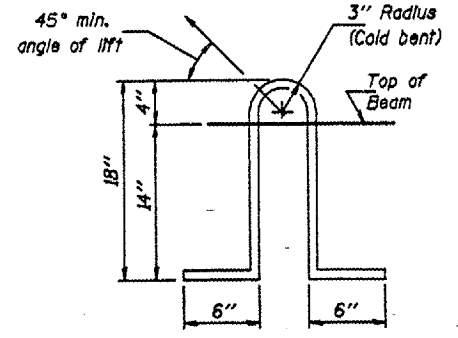

LIFTING LOOP DETAIL

Lifting loops shall be 2, 1/2"-270 ksi strands, as shown. Alternate approved lifting devices are also acceptable.

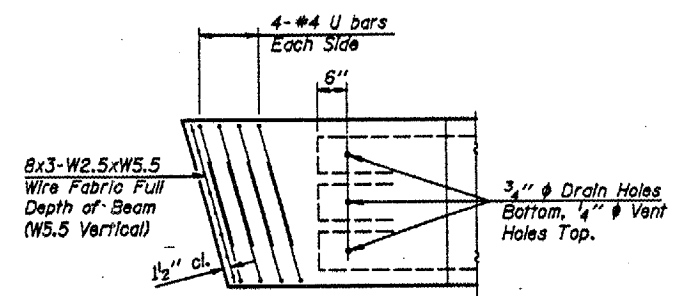

END REINFORCEMENT
(SKEWED)

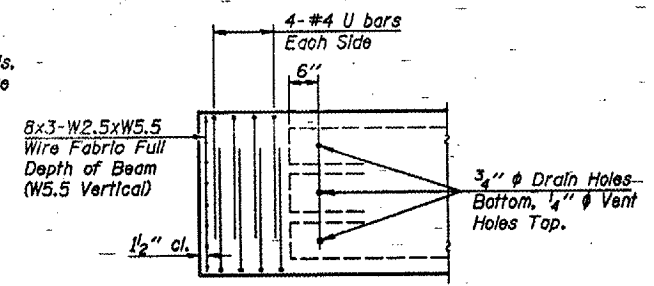

END REINFORCEMENT
(RIGHT ANGLE)

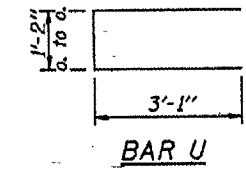

BAR U

MIN. BAR LAP

#5 bars = 1'-8"

DESIGN STRESSES

- $f'_c = 5,000$ p.s.i.
- $f'_s = 4,000$ p.s.i.
- $f'_s = 270,000$ p.s.i. (1/2" ϕ Strand)
- $f'_s = 201,960$ p.s.i. (1/2" ϕ Strand)
- $f_y = 60,000$ p.s.i.

Illinois Department of Transportation

PASSED APRIL 4, 2005

Theresa S. Nemes (Signature)

Engineer of Office Design

APPROVED APRIL 4, 2005

Ralph E. (Signature)

Engineer of Bridges and Structures

NOTE

The std. reinf. and dimensions shown on the 25' span cross section is typical for all spans, except as shown.

P.P.C. DECK BEAM DETAILS

24' ROADWAY | 17" x 48" BEAMS

STANDARD CB-2417-48