

F.A.I. RTE.	SECTION	COUNTY	TOTAL SHEETS	SHEET NO.
90/94	2021-922PT.1-AC	COOK	460	122
STA.	TO STA.			
FED. ROAD DIST. NO. 1	ILLINOIS	FED. AID PROJECT		

62693

M-4.48 MOD C&G TRANSITION TO M-4.24 C&G
N.T.S.

STA 9008+48.92
STA 9010+72.18
STA 9509+62.37
STA 9511+34.61

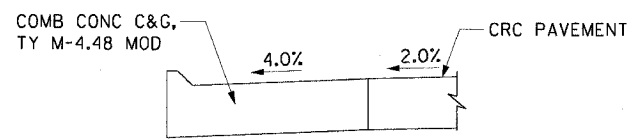
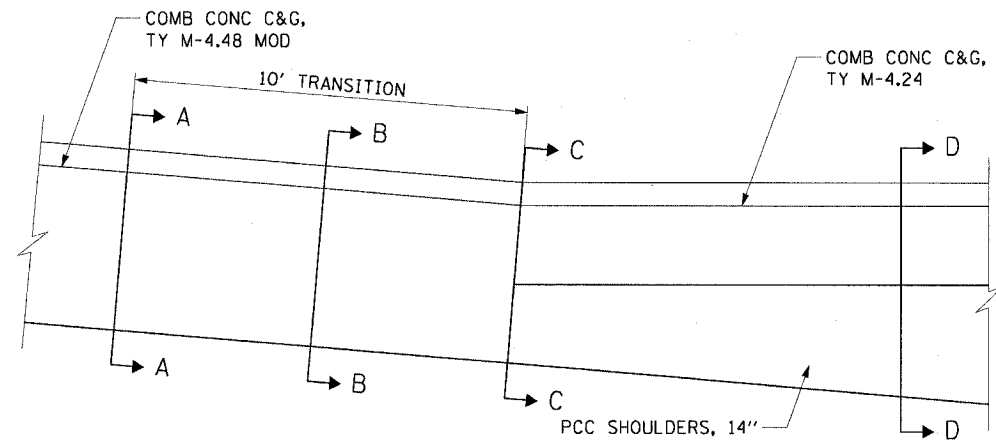

SECTION A-A
N.T.S.

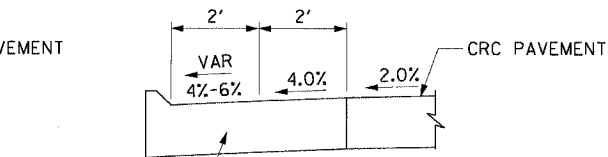

SECTION B-B
N.T.S.

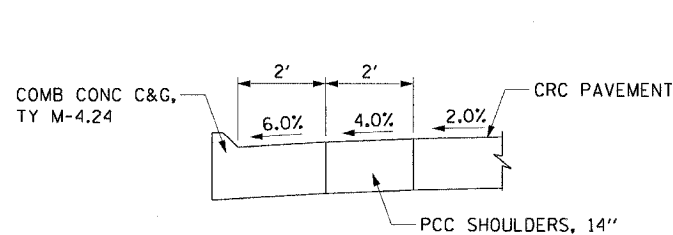

SECTION C-C
N.T.S.

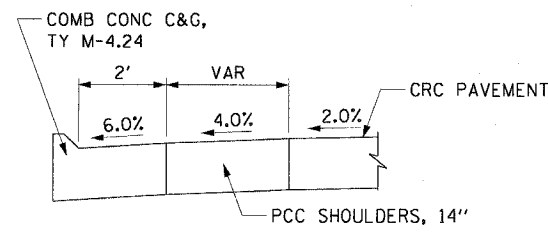

SECTION D-D
N.T.S.

NOTE: THE TRANSITION SECTION SHALL BE PAID FOR AS COMB CONC C&G, TY M-4.48 MOD

CONCRETE BARRIER TRANSITION TO PIER/ABUTMENT
N.T.S.

STA 3428+55.12

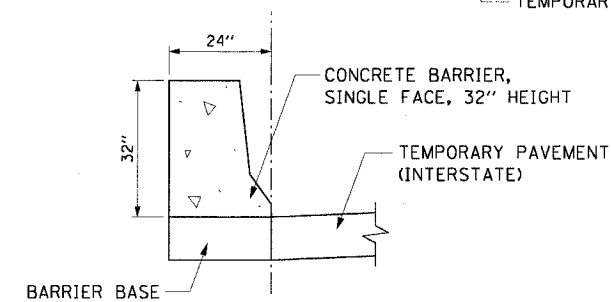
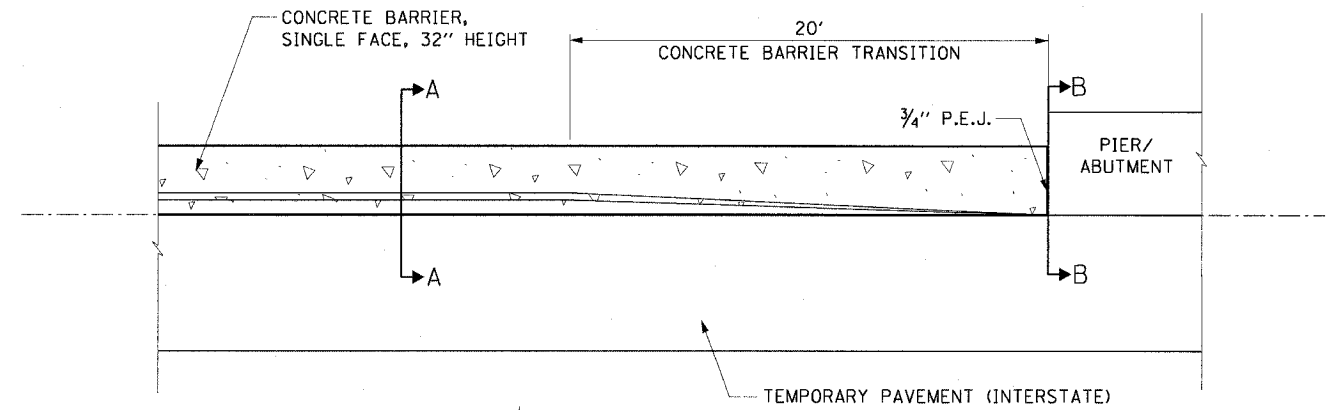

SECTION A-A
N.T.S.

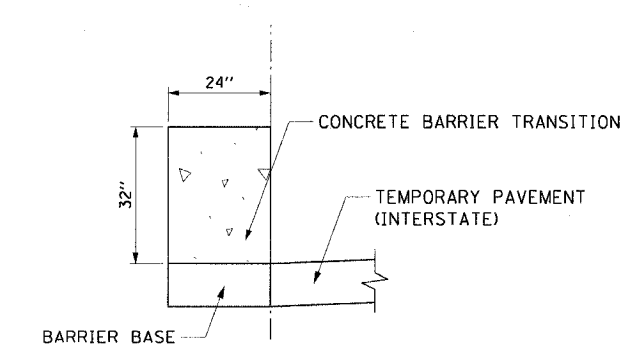

SECTION B-B
N.T.S.

NOTES:

1. THE 3/4" PREFORMED EXPANSION JOINT SHALL BE INCLUDED IN THE COST OF CONCRETE BARRIER TRANSITION.
2. SEE ROADWAY DETAIL SHEET NO. 4 FOR CONCRETE BARRIER, SINGLE FACE, 32" HEIGHT DETAILS.

REVISIONS	
NAME	DATE

ILLINOIS DEPARTMENT OF TRANSPORTATION
F.A.I. 90/94 (DAN RYAN EXPRESSWAY)
63rd ST TO 59th ST (FRONTAGE ROAD & RAMPS)
ROADWAY DETAILS
CONCRETE BARRIER TRANSITION AND
M-4.48 MOD C&G TRANSITION TO M-4.24 C&G
SCALE: NONE
DATE: October 29, 2004
DRAWN BY: NJH
CHECKED BY: RWG

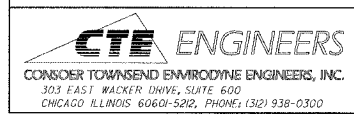

M:\P\40468\CIVIL\40468-CITRISSE-SFR-Roadway-Detail\11-03-2004-03:24:15 PM