

*SOUTHERN DUPAGE REGIONAL TRAIL
 GREENE VALLEY SPUR
 CONTRACT NO. 83775

RTE. NO.	SECTION	COUNTY	TOTAL SHEETS	SHEET NO.
02-00001-05-BT	DUPAGE	DUPAGE	113	23
STA. N/A		TO STA. N/A		
FED. ROAD DIST. NO.		ILLINOIS FED. AID PROJECT		

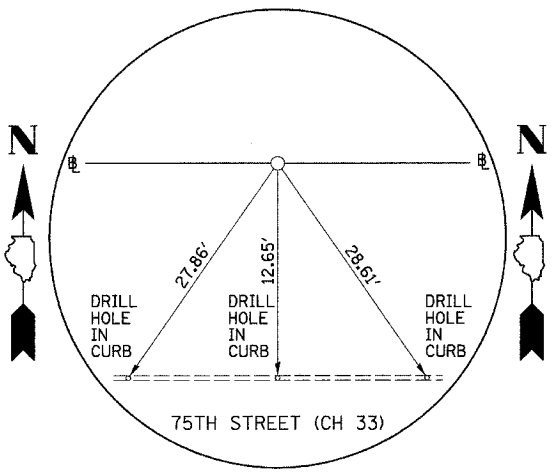

PI STA. 411+68.00
 75TH STREET (CH 33)
 (5/8" I-ROD)

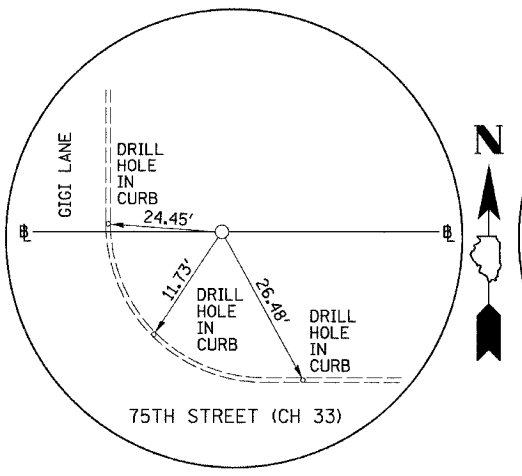

PI STA. 413+15.16
 75TH STREET (CH 33)
 (5/8" I-ROD)

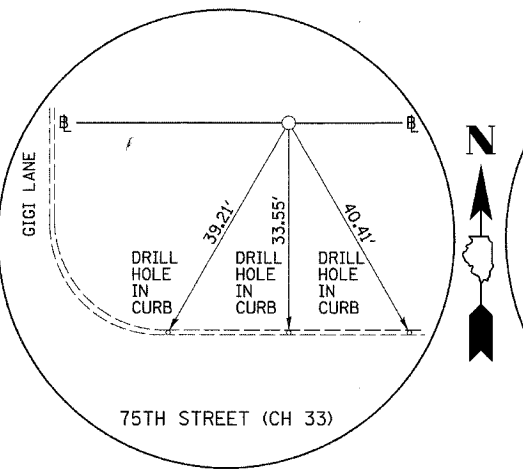

PI STA. 413+62.62
 75TH STREET (CH 33)
 (5/8" I-ROD)

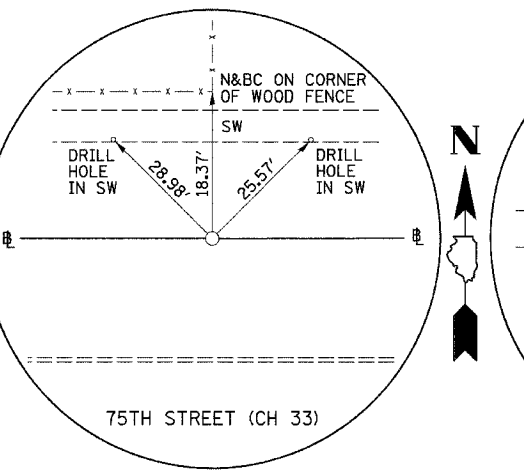

POT STA. 419+00.00
 75TH STREET (CH 33)
 (5/8" I-ROD)

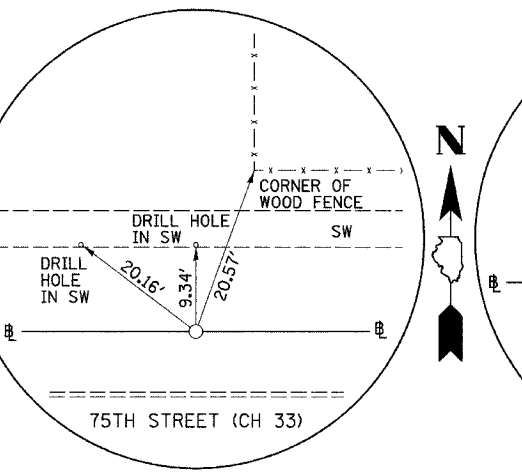

PI STA. 424+96.15
 75TH STREET (CH 33)
 (5/8" I-ROD)

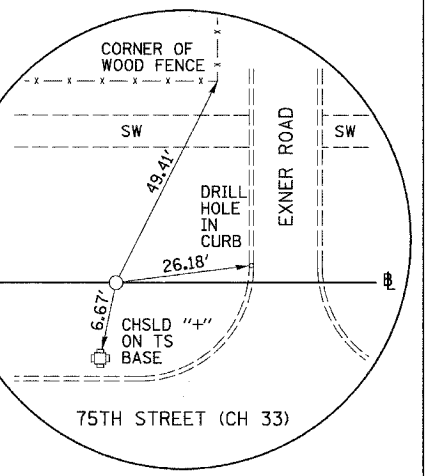

PI STA. 425+78.42
 75TH STREET (CH 33)
 (5/8" I-ROD)

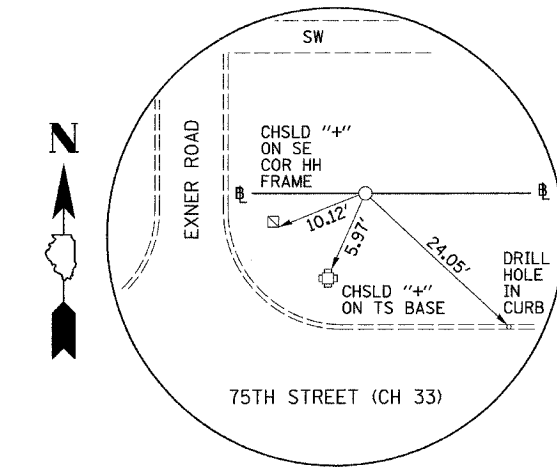

PI STA. 426+83.96
 75TH STREET (CH 33)
 (5/8" I-ROD)

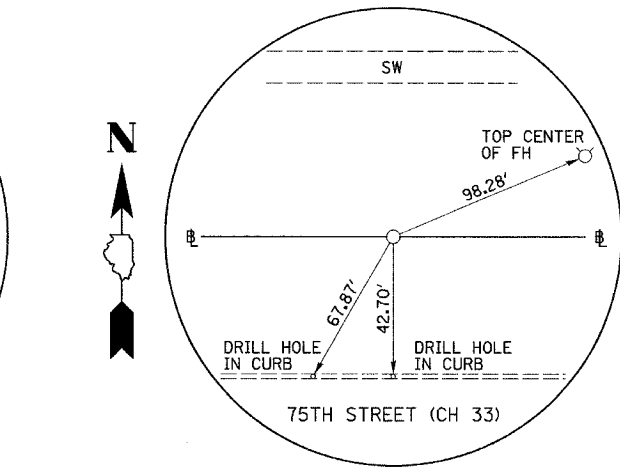

PI STA. 427+61.58
 75TH STREET (CH 33)
 (5/8" I-ROD)

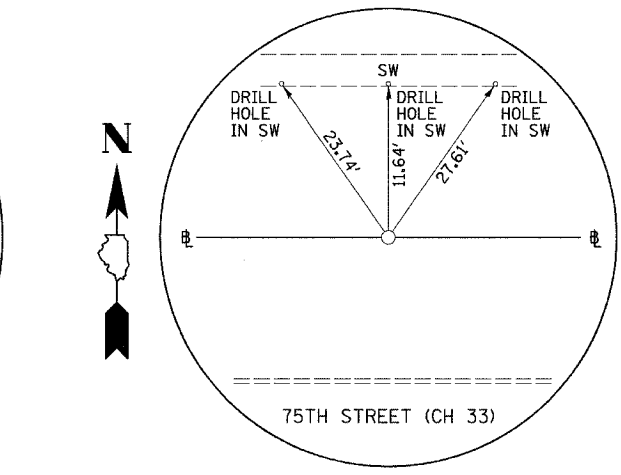

PI STA. 431+68.45
 75TH STREET (CH 33)
 (5/8" I-ROD)

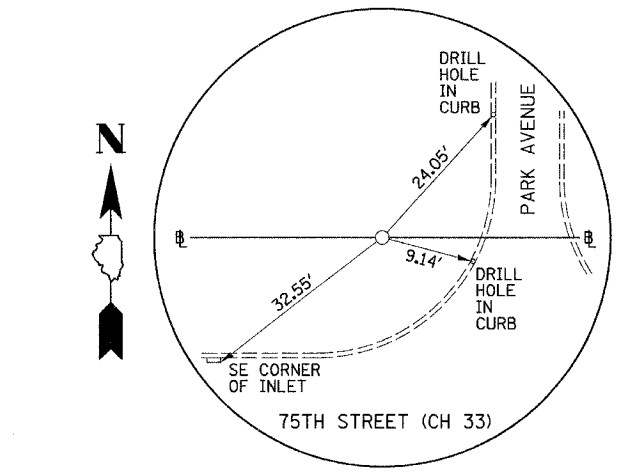

PI STA. 432+49.16
 75TH STREET (CH 33)
 (5/8" I-ROD)

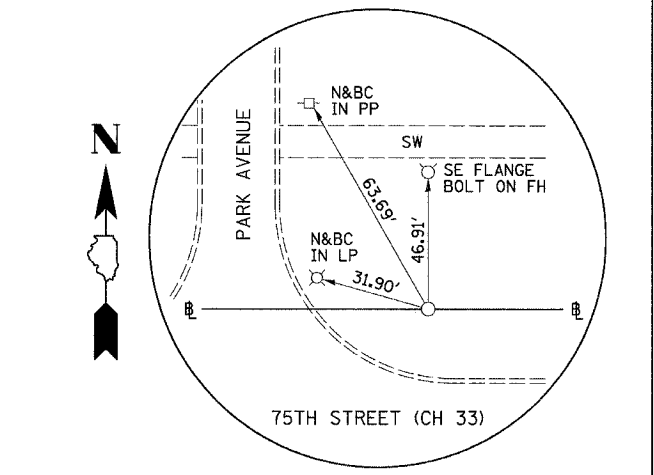

PI STA. 433+68.18
 75TH STREET (CH 33)
 (5/8" I-ROD)

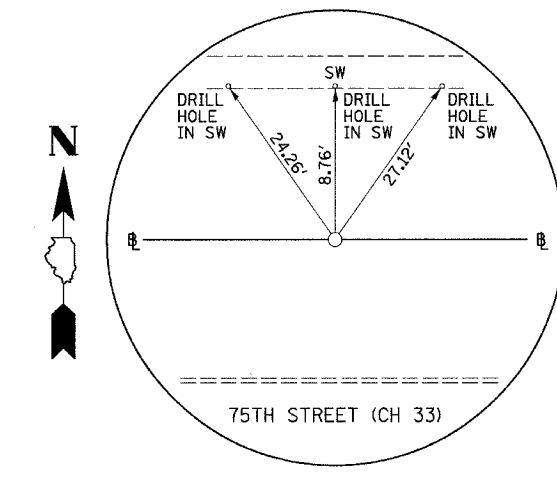

PI STA. 435+46.22
 75TH STREET (CH 33)
 (5/8" I-ROD)

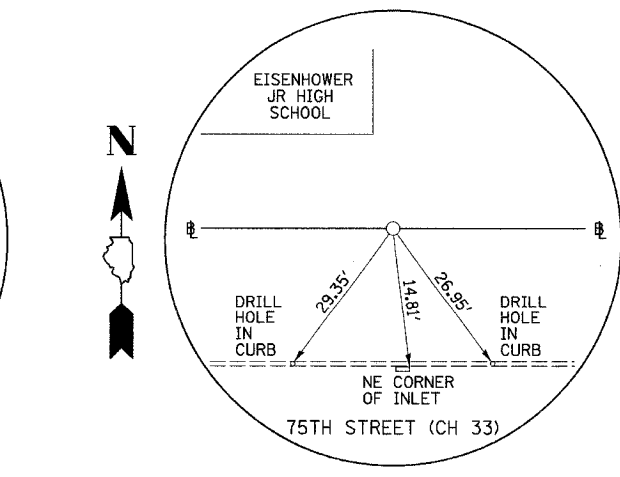

PI STA. 437+68.45
 75TH STREET (CH 33)
 (5/8" I-ROD)

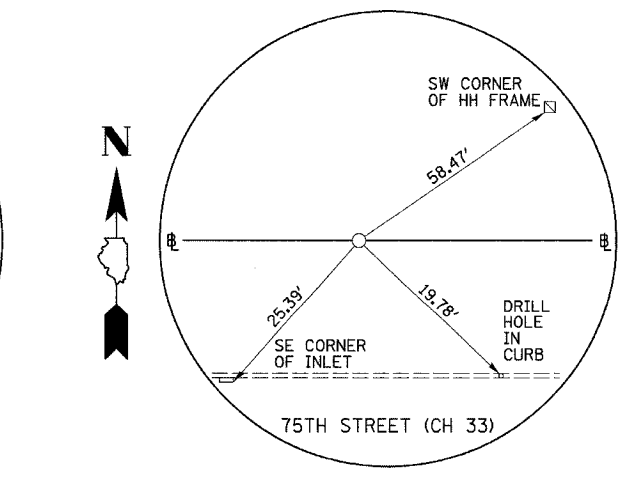

PI STA. 440+38.35
 75TH STREET (CH 33)
 (5/8" I-ROD)

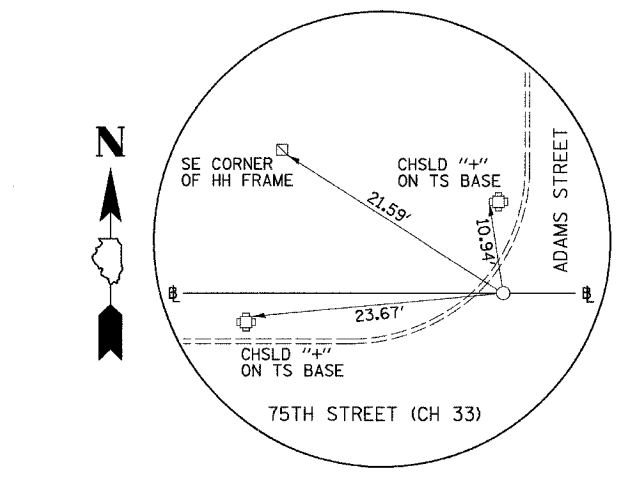

PI STA. 441+18.12
 75TH STREET (CH 33)
 (PK NAIL)

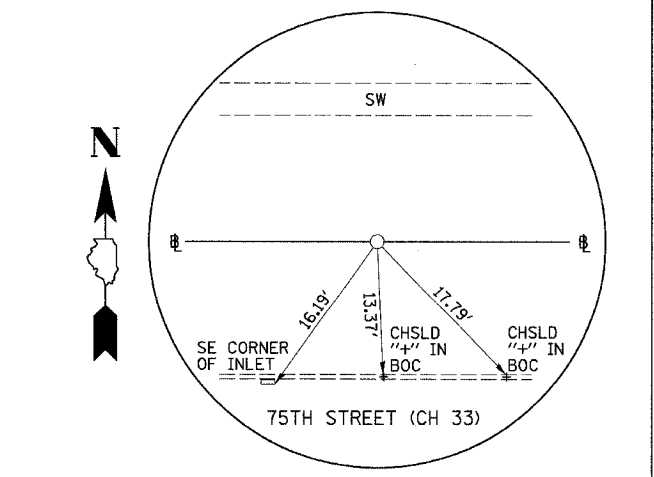

PI STA. 442+24.52
 75TH STREET (CH 33)
 (5/8" I-ROD)