

03-08-2024 LETTING ITEM 172

**STATE OF ILLINOIS
DEPARTMENT OF TRANSPORTATION**

FOR INDEX OF SHEETS, SEE SHEET NO. 2

PROPOSED HIGHWAY PLANS

**ROUTE: VARIOUS DISTRICT ONE
SECTION: 2022 VAR SWEEPING MHKA
ARTERIAL HIGHWAY CLEANING (SWEEPING)
COUNTY: KANE AND McHENRY
C-91-105-23**

* KANE & McHENRY

D-91-074-23

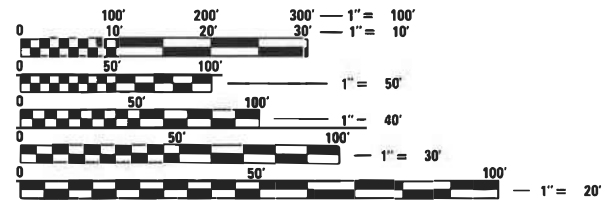

FULL SIZE PLANS HAVE BEEN PREPARED USING STANDARD ENGINEERING SCALES. REDUCED SIZED PLANS WILL NOT CONFORM TO STANDARD SCALES. IN MAKING MEASUREMENTS ON REDUCED PLANS, THE ABOVE SCALES MAY BE USED.

J.U.L.I.E.
JOINT UTILITY LOCATION INFORMATION FOR EXCAVATION
1-800-892-0123
OR 811

LOCATION MAPS - SEE INDEX OF SHEETS

PROJECT ENGINEER: RODRIGO LEDEZMA (847) 705-4580
PROJECT MANAGER: J. ALAIN MIDY (847) 221-3056

CONTRACT NO. 62U68

STATE OF ILLINOIS
DEPARTMENT OF TRANSPORTATION

SUBMITTED: ~~JANUARY 27~~ 20 23
[Signature]
REGIONAL ENGINEER

December 8, 2023
[Signature]
ENGINEER OF DESIGN AND ENVIRONMENT

December 8, 2023
[Signature]
DIRECTOR OF HIGHWAYS PROJECT IMPLEMENTATION

**PRINTED BY THE AUTHORITY
OF THE STATE OF ILLINOIS**

INDEX OF SHEETS

1. TITLE SHEET
2. INDEX OF SHEETS
APPLICABLE STATE STANDARDS
3. SUMMARY OF QUANTITIES
SCHEDULE OF CLEANING STARTING DATES
4. ARTERIAL TYPICAL SECTIONS
5. ARTERIAL CLEANING: McHENRY COUNTY
WOODSTOCK TEAM SECTION
6. ARTERIAL CLEANING: KANE COUNTY
ST. CHARLES TEAM SECTION
7. TRAFFIC CONTROL AND PROTECTION FOR SIDE ROADS,
INTERSECTIONS AND DRIVEWAYS (TC-10)

STATE STANDARDS

701426-09	LANE CLOSURE, MULTILANE INTERMITTENT OR MOVING OPERATION FOR SPEEDS > 45 MPH
701427-05	LANE CLOSURE, MULTILANE, INTERMITTENT OR MOVING OPERATIONS < 40 MPH
701901-09	TRAFFIC CONTROL DEVICES

MODEL: Default
 FILE: \\nas11.pwllidnet-pw.bentley.com:PWIDOT\Documents\DOT Offices\District 1\Projects\Sweeping_Contracts\CADData\Design\SweepingContract2022.dgn

** 2022 VAR SWEEPING MH/KA ■ KANE & McHENRY

	USER NAME = rodrigo.ledezma	DESIGNED -	REVISED -	STATE OF ILLINOIS DEPARTMENT OF TRANSPORTATION	INDEX OF SHEETS AND STATE STANDARDS	F.A. RTE.	SECTION	COUNTY	TOTAL SHEETS	SHEET NO.	
		DRAWN -	REVISED -			VAR	**	*	7	2	
	PLOT SCALE = 100.0000' / in.	CHECKED -	REVISED -			CONTRACT NO. 62U68					
	PLOT DATE = 10/27/2023	DATE -	REVISED -			SCALE:	SHEET	OF	SHEETS	STA.	TO
						ILLINOIS FED. AID PROJECT					

SUMMARY OF QUANTITIES

CODE NO.	ITEM	UNIT	URBAN	100 % STATE 0044	100 % STATE 0044
			TOTAL QUANTITIES	ARTERIAL KANE CO.	ARTERIAL MCHENRY CO.
Z0010617	SUPPLEMENTAL SWEEPING	MILE	50	25	25
X0330600	FULL ARTERIAL CLEANING CYCLE	EACH	8	4	4

NOTES:

- SCHEDULE MAY VARY AS DIRECTED BY THE ENGINEER.
- THE CONTRACTOR MAY NOT START CLEANING CYCLES BEFORE AN AUTHORIZED WORK ORDER HAS BEEN SUBMITTED TO THE CONTRACTOR BY THE ENGINEER.
- NO WORK WILL BE ALLOWED DURING ANY LEGAL HOLIDAY PERIOD.
- NO DAILY CONTRACTOR WORK REQUESTS/ SCHEDULING SHALL BE AUTHORIZED OR APPROVED TO START WHEN IT IS DETERMINED BY THE ENGINEER THAT WEATHER CONDITIONS WILL BE UNFAVORABLE. APPROVAL OF ALL DAILY CONTRACTOR WORK SCHEDULE REQUEST SHALL BE SOLELY DETERMINED BY THE ENGINEER AND OR PROJECT SUPERVISOR.
- ALL LANE AND SHOULDER CLOSURES SHALL BE IMMEDIATELY REMOVED DURING ALL ADVERSE WEATHER CONDITIONS **WITHOUT EXCEPTION**, INCLUDING BUT NOT LIMITED TO RAIN, WET ROAD SURFACE (SPRAY FROM TIRES), MIST, DRIZZLE, SLEET, SNOW, FOG AND ANY OTHER CIRCUMSTANCE DETERMINED UNSAFE BY THE ENGINEER. **THE CONTRACTOR SHALL IMPLEMENT THIS CONTRACT REQUIREMENT IMMEDIATELY WITHOUT WAITING FOR DEPARTMENT INSTRUCTIONS.**
- BECAUSE SWEEPING OPERATIONS NEED WATER TO WORK EFFECTIVELY, SWEEPING WILL **NOT** BE ALLOWED WHEN TEMPERATURES OR WIND CHILL FACTORS ARE FORECASTED BY THE DEPARTMENTS CERTIFIED CONSULTING METEOROLOGISTS TO BE AT OR DROP BELOW FREEZING. **TEMPERATURE MUST BE ABOVE THIRTY TWO (32) DEGREES FARENHEIT.** ALL SHOULDER AND CURB LINES MUST BE FREE OF ANY EXISTING SNOW AND OR ICE. DRY SWEEPING SHALL BE ALLOWED ONLY IF IT IS CONSIDERED AN EMERGENCY, IMMEDIATE HAZARD, OR ANY WORK AS DESIGNATED BY THE DEPARTMENT THAT REQUIRES FIRST PRIORITY CORRECTIVE ACTION.
- NO** WORK WILL BE ALLOWED DAY OR NIGHT ON THE FOLLOWING DATES UNLESS IT IS CONSIDERED AN EMERGENCY, IMMEDIATE HAZARD OR ANY WORK AS DESIGNATED BY THE DEPARTMENT THAT REQUIRES FIRST PRIORITY CORRECTIVE ACTION:

2022:	APRIL 15 - APRIL 18 MAY 27 - MAY 31 JULY 1 - JULY 5 SEPTEMBER 2 - SEPTEMBER 6 NOVEMBER 23 - NOVEMBER 28 DECEMBER 23 - JANUARY 2/2023	EASTER HOLIDAY MEMORIAL DAY HOLIDAY INDEPENDENCE DAY HOLIDAY LABOR DAY HOLIDAY THANKSGIVING HOLIDAY CHRISTMAS/NEW YEAR'S HOLIDAY
2023:	APRIL 7 - APRIL 10 MAY 26 - MAY 30 JULY 1 - JULY 5 SEPTEMBER 1 - SEPTEMBER 5 NOVEMBER 22 - NOVEMBER 27 DECEMBER 22 - JANUARY 1/2024	EASTER HOLIDAY MEMORIAL DAY HOLIDAY INDEPENDENCE DAY HOLIDAY LABOR DAY HOLIDAY THANKSGIVING HOLIDAY CHRISTMAS/NEW YEAR'S HOLIDAY

**2022 VAR SWEEPING MH/KA * KANE & MCHENRY

MODEL: Default
FILE NAME: \\sulfur-caw-bentley.com\P\W\DOT\Documents\DOT Office\District 1\Projects\Sweeping_Contracts\CAD\Drawings\SweepingContract2022.dgn

USER NAME = rodrigo.ledezma	DESIGNED -	REVISED -	STATE OF ILLINOIS DEPARTMENT OF TRANSPORTATION	SUMMARY OF QUANTITIES AND SCHEDULE OF STARTING DATES		F.A. RTE.	SECTION	COUNTY	TOTAL SHEETS	SHEET NO.
PLOT SCALE = 100,0000' / in.	DRAWN -	REVISED -				VAR	**	*	7	3
PLOT DATE = 10/27/2023	CHECKED -	REVISED -		SCALE: SHEET OF SHEETS STA. TO STA.		CONTRACT NO. 62U68				
	DATE -	REVISED -				ILLINOIS FED. AID PROJECT				

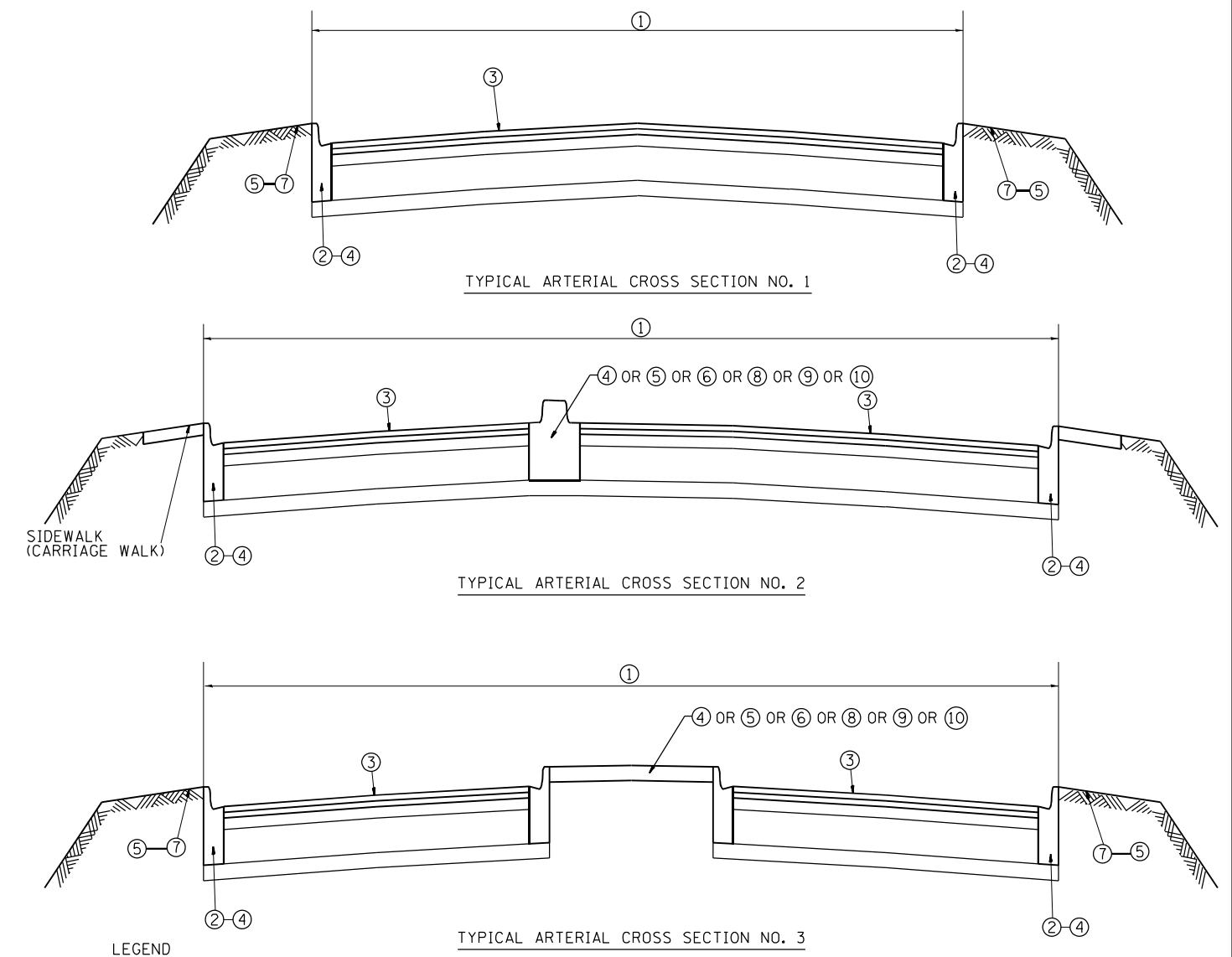
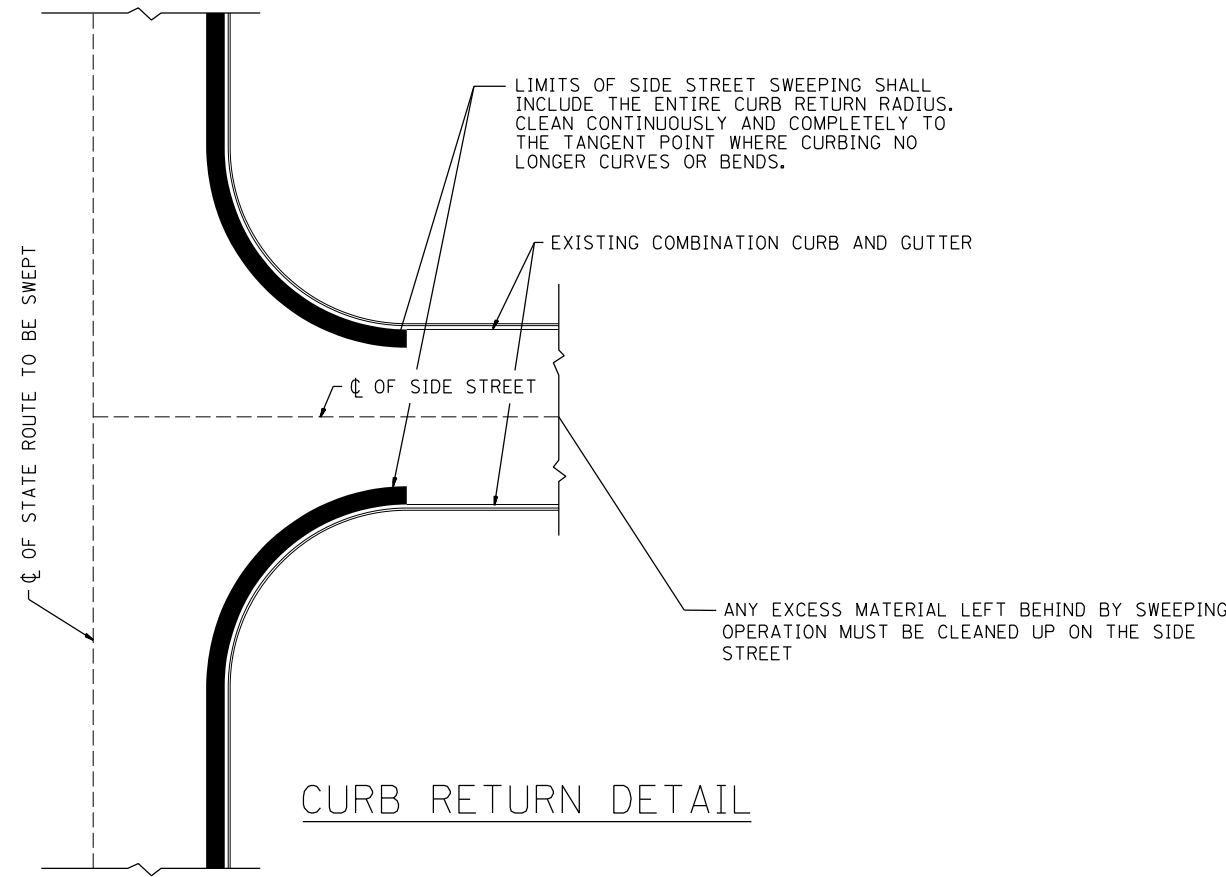

- LEGEND**
- ① AREA OF ROADWAY CLEANING AND RUBBISH REMOVAL
 - ② CURB AND GUTTER
 - ③ TRAVELED ROADWAY
 - ④ STABILIZED SHOULDER OR MEDIAN
 - ⑤ STEEL PLATE GUARDRAIL (SEE NOTE 1)
 - ⑥ CONCRETE BARRIER
 - ⑦ NON STABILIZED AREA
 - ⑧ RAISED CONCRETE MEDIAN
 - ⑨ ALL EXISTING TURF MEDIANS
 - ⑩ LITTER PICKING

- NOTES:**
- 1) ALL LOCATIONS OF MEDIANS AND GUARDRAILS SHALL BE CLEANED OF ALL DEBRIS AND RUBBISH INCLUDING BUT NOT LIMITED TO DIRT, WEEDS, SAND, ROCKS, GRAVEL, CONCRETE, WOOD, LIMBS, LEAVES, GARBAGE & ANIMAL CARCASSES BY HAND LABORING UNDERNEATH AND 10 FEET BEHIND GUARDRAIL INCLUDING STABILIZED AND NON STABILIZED AREAS. THIS WORK SHALL BE CONSIDERED AS INCLUDED IN THE CONTRACT UNIT PRICE FOR ALL FULL CLEANING CYCLES.
 - 2) SLOPE WALLS UNDER BRIDGES ARE NOT INCLUDED IN AREAS TO BE CLEANED.
 - 3) ALL ARTERIAL INTERCHANGES, INTERSECTIONS, RAMPS AND CROSSOVERS SHALL BE CLEANED AND LITTER PICKED.
 - 4) ALL PAVED DITCHES AND SPILLWAYS WITHIN 10' OF STABILIZED BASE SHALL BE CLEANED

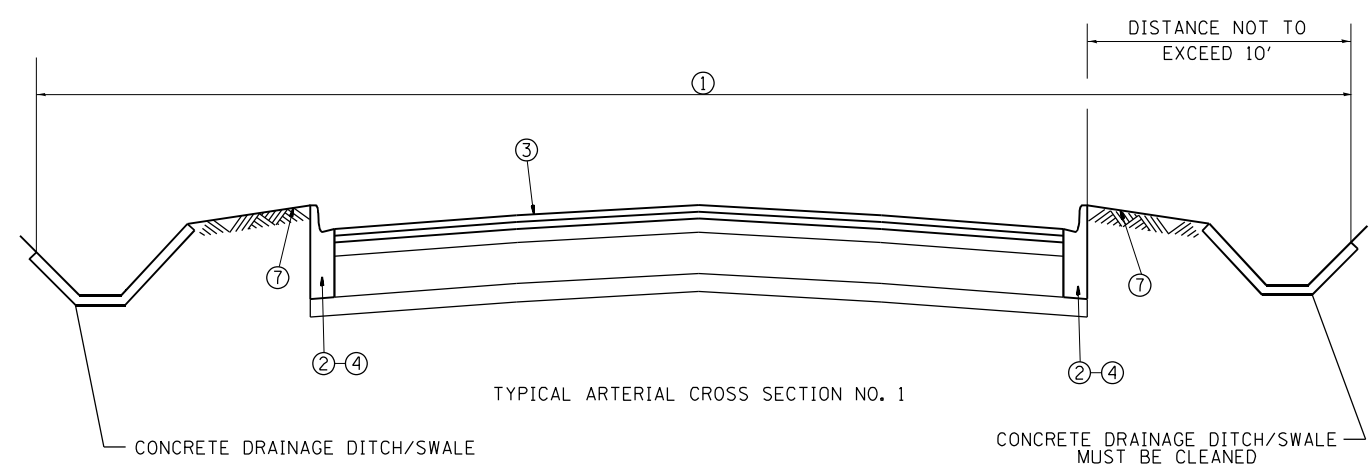
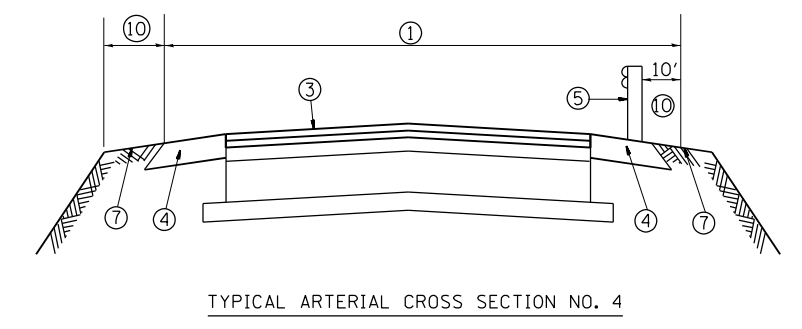

MODEL: Default
FILE NAME: p:\bulletect-sweeping\contracts\CAD\Drawings\Sweeping\Contract2022.dwg
PROJECT: Sweepings\DOT Offices\District 11\Projects\Sweeping_Contracts\CAD\Drawings\Sweeping\Contract2022.dwg

USER NAME = rodrigo.ledezma	DESIGNED -	REVISED -
DRAWN -	REVISOR -	REVISOR -
PLOT SCALE = 100,0000' / in.	CHECKED -	REVISOR -
PLOT DATE = 10/27/2023	DATE -	REVISOR -

**STATE OF ILLINOIS
DEPARTMENT OF TRANSPORTATION**

**TYPICAL ARTERIAL CROSS SECTION
AND CURB RETURN DETAIL**

SCALE: SHEET OF SHEETS STA. TO STA.

** 2022 VAR SWEEPING MH/KA * KANE & McHENRY

F.A. RTE.	SECTION	COUNTY	TOTAL SHEETS	SHEET NO.
VAR	**	*	7	4
CONTRACT NO. 62U68				
ILLINOIS FED. AID PROJECT				

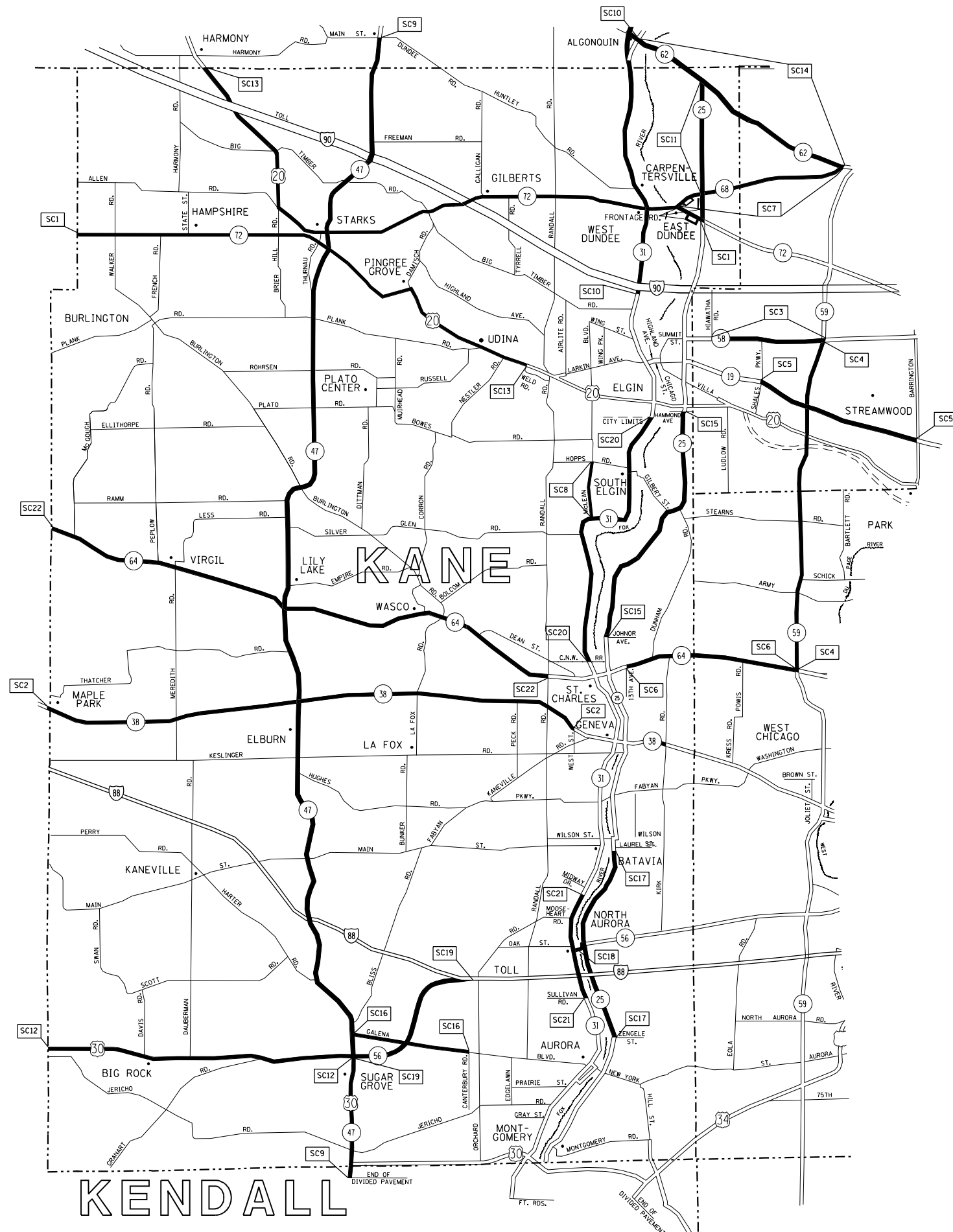

TEAM SECTION ST. CHARLES
KEY LOCATIONS SC1 - SC22

DISTRICT NO. 1
 ——— STATE HIGHWAYS & EXPRESSWAYS WITHIN STATE JURISDICTION (EXCEPT TOLLWAYS)
 ——— STATE HIGHWAYS & EXPRESSWAYS TO BE CLEANED
 - - - FUTURE HIGHWAYS
 ——— VARIOUS AGENCIES HIGHWAYS

** 2022 VAR SWEEPING MH/KA * KANE & McHENRY

MODEL: Default
 FILE NAME: p:\illicit-sweeping\contracts\CAD\Drawings\Kane\SweepingContract2022.dwg
 PROJECT: Sweeping
 CONTRACT: CAD\Drawings\Kane\SweepingContract2022.dwg

USER NAME = rodrigo.ledezma	DESIGNED -	REVISED -
DRAWN -	REVISED -	REVISED -
PLOT SCALE = 100,000' / in.	CHECKED -	REVISED -
PLOT DATE = 10/27/2023	DATE -	REVISED -

**STATE OF ILLINOIS
DEPARTMENT OF TRANSPORTATION**

ARTERIAL CLEANING LOCATION MAP			
KANE COUNTY ST. CHARLES TEAM SECTION			
SCALE:	SHEET	OF SHEETS	STA. TO STA.

F.A. RTE.	SECTION	COUNTY	TOTAL SHEETS	SHEET NO.
VAR	**	*	7	6
CONTRACT NO. 62U68				
ILLINOIS FED. AID PROJECT				

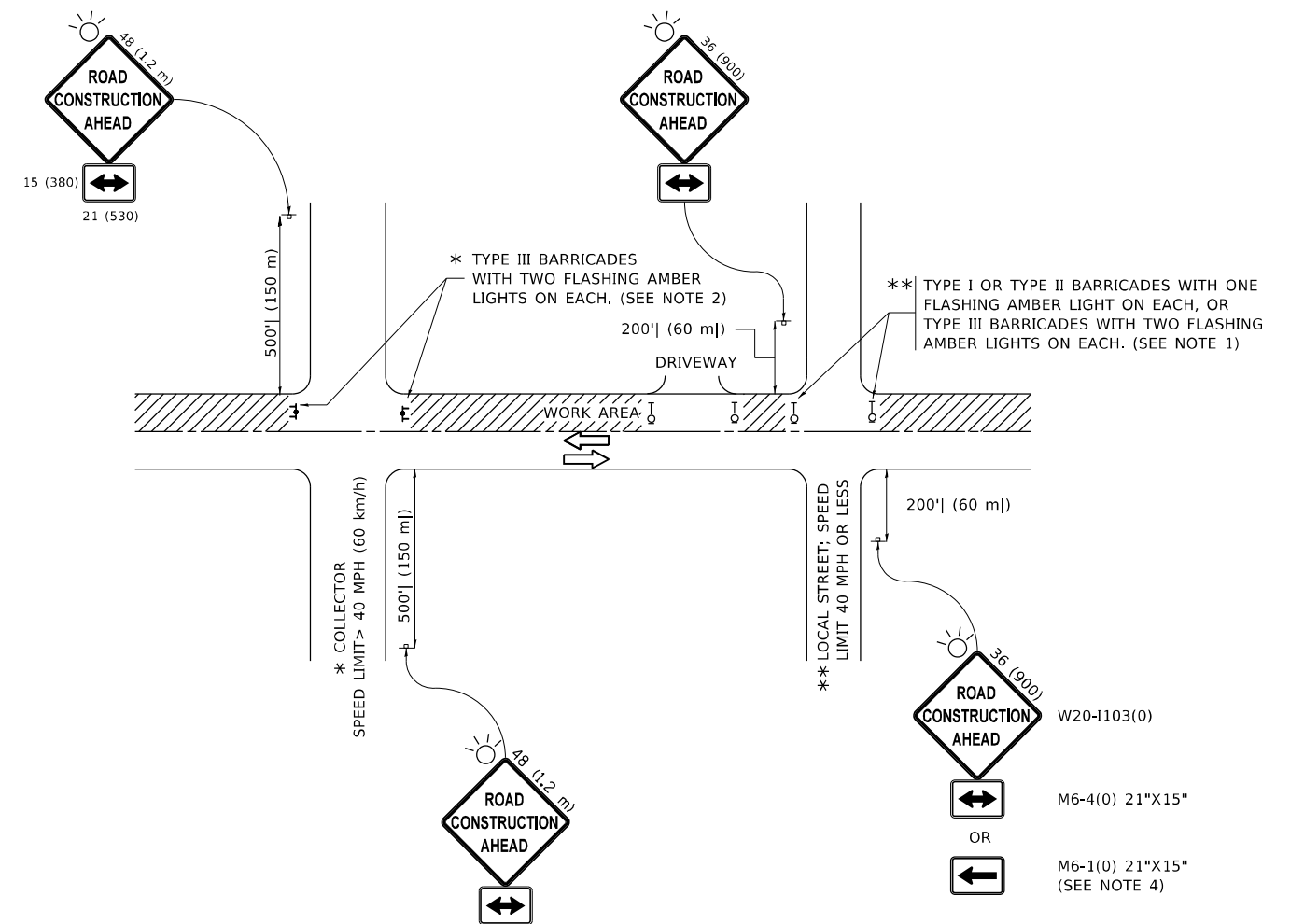

NOTES:

1. SIDE ROAD WITH A SPEED LIMIT OF 40 MPH (60 km/h) OR LESS AS SHOWN ON THE DRAWING AND AS DIRECTED BY THE ENGINEER:
 - a) ONE "ROAD CONSTRUCTION AHEAD" SIGN 36 x 36 (900x900) WITH A FLASHER MOUNTED ON IT APPROXIMATELY 200' (60 m) IN ADVANCE OF THE MAIN ROUTE.
 - b) THE CLOSED PORTION OF THE MAIN ROUTE SHALL BE PROTECTED BY BLOCKING WITH TYPE I, TYPE II OR TYPE III BARRICADES, 1/3 OF THE CROSS SECTION OF THE CLOSED PORTION.
2. SIDE ROAD WITH A SPEED LIMIT GREATER THAN 40 MPH (60 km/h) AS SHOWN ON THE DRAWING AND AS DIRECTED BY THE ENGINEER:
 - a) ONE "ROAD CONSTRUCTION AHEAD" SIGN 48 x 48 (1.2 m x 1.2 m) WITH A FLASHER MOUNTED ON IT APPROXIMATELY 500' (150 m) IN ADVANCE OF THE MAIN ROUTE.
 - b) BLOCKING WITH TYPE III BARRICADES, 1/2 OF THE CROSS SECTION OF THE CLOSED PORTION.
3. CONES MAY BE SUBSTITUTED FOR BARRICADES OR DRUMS AT HALF THE SPACING DURING DAY OPERATIONS. CONES SHALL BE A MINIMUM OF 28 (710) IN HEIGHT.
4. SIGNING AND THE WORK ZONE, A SINGLE HEADED ARROW (M6-1) SHALL BE USED IN LIEU OF THE DOUBLE HEADED ARROW (M6-4).
5. WHEN WORK IS BEING PERFORMED ON A SIDE ROAD OR DRIVEWAY, FOLLOW THE APPLICABLE STANDARD(S). THE DIRECTIONAL ARROW (M6-1 OR M6-4) SHALL BE COVERED OR REMOVED WHEN NO LONGER CONSISTENT WITH THE TRAFFIC CONTROL SET-UP.
6. ADVANCE WARNING SIGNS ARE TO BE OMITTED ON DRIVEWAYS UNLESS OTHERWISE SPECIFIED IN THE PLANS OR BY THE ENGINEER.
7. THE TRAFFIC CONTROL AND PROTECTION FOR SIDE ROADS, INTERSECTIONS, AND DRIVEWAYS SHALL BE INCLUDED IN THE COST OF SPECIFIED TRAFFIC CONTROL STANDARDS OR ITEMS.

**2022 VAR SWEEPING MH/KA * KANE & MCHENRY
All dimensions are in inches (millimeters) unless otherwise shown.

MODEL: Default
FILE NAME: p:\bulletect-pw-bead\paw.com\FW\DOT\Documents\DOT Office\Dir\rdet_1\Project\Sweeping_Contracts\CAD\Drawings\Drawings\Sweeping\Contract2022.dwg

USER NAME = rodrigo.ledezma	DESIGNED - L.H.A.	REVISED - A. HOUSEH 10-15-96
PLOT SCALE = 100,0000' / in.	CHECKED -	REVISED - T. RAMMACHER 01-06-00
PLOT DATE = 10/27/2023	DATE - 06-89	REVISED - A. SCHUETZE 07-01-13
		REVISED - A. SCHUETZE 09-15-16

**STATE OF ILLINOIS
DEPARTMENT OF TRANSPORTATION**

**TRAFFIC CONTROL AND PROTECTION FOR
SIDE ROADS, INTERSECTIONS, AND DRIVEWAYS**

SCALE: NONE SHEET 1 OF 1 SHEETS STA. TO STA.

F.A. RTE.	SECTION	COUNTY	TOTAL SHEETS	SHEET NO.
VAR	**	*	7	7
TC-10			CONTRACT NO. 62U68	
ILLINOIS FED. AID PROJECT				