

MINIMUM MANHOLE DIMENSIONS

PIPE SIZE	MIN. DIAMETER	MIN. WALL THICKNESS
8" - 18"	4"	5"
24" - 36"	6"	7"

(OR AS DIRECTED BY THE DISTRICT)

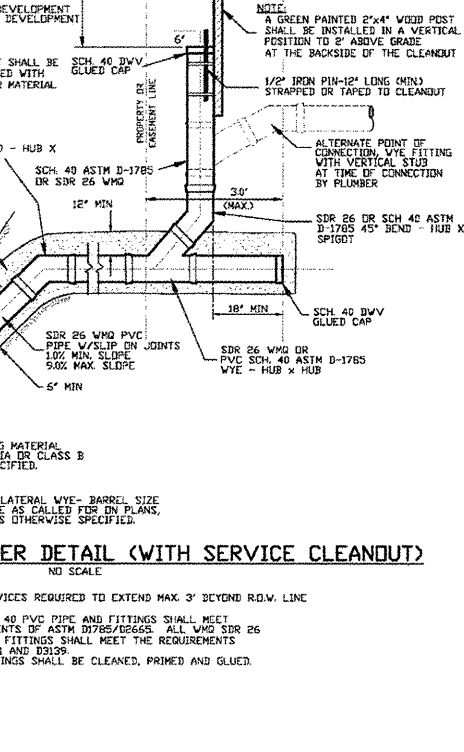
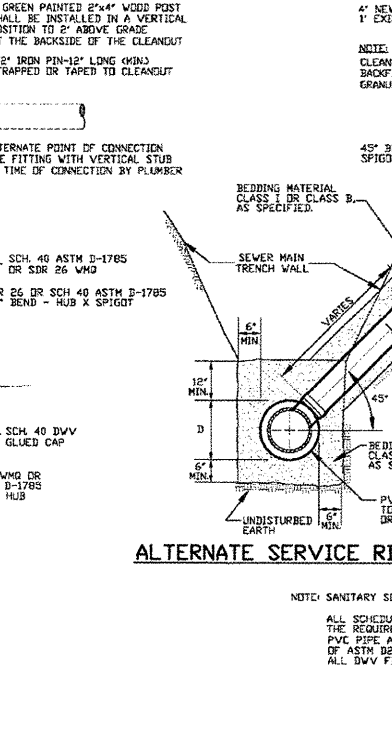
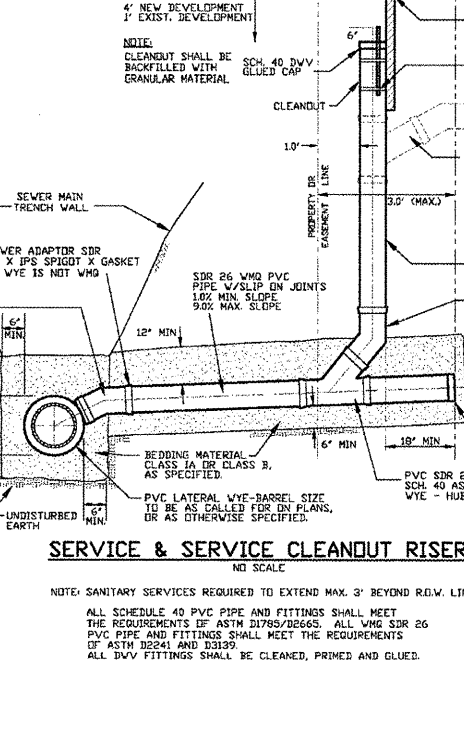
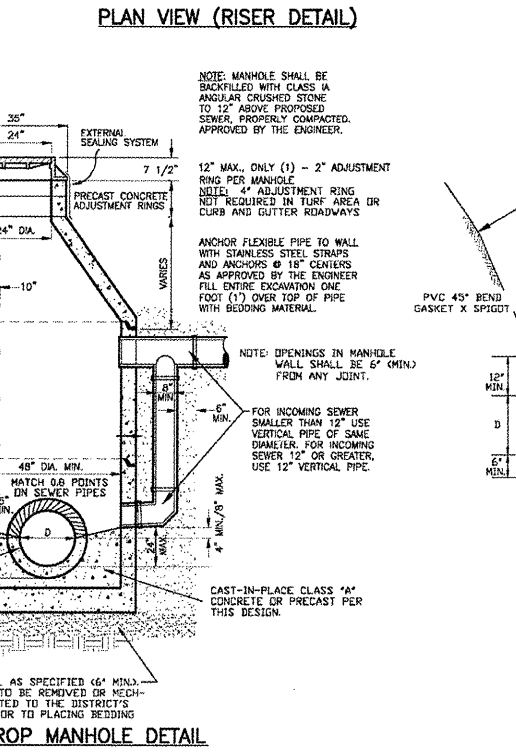
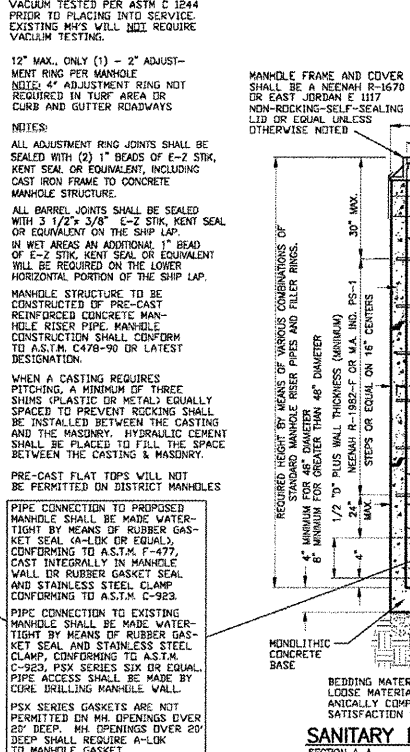
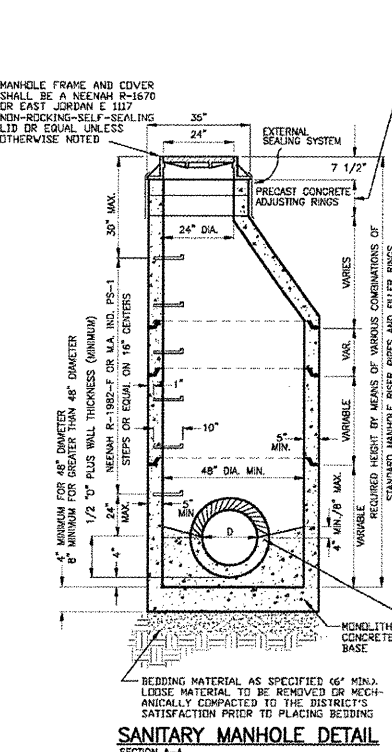
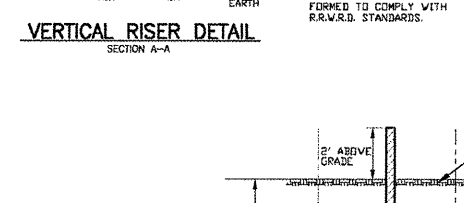
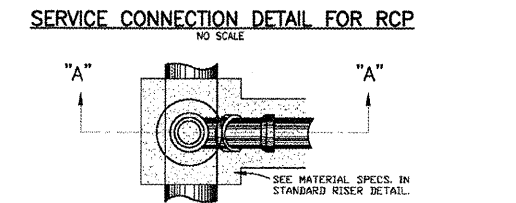
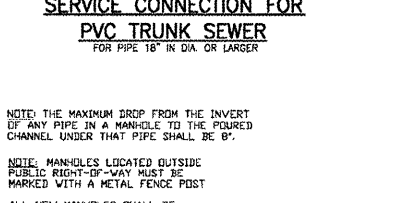

USER NAME = Steve Prange	DESIGNED - SJP / MNB	REVISED -
PLOT SCALE = 2,0000' / IN.	DRAWN - ERD	REVISED -
PLOT DATE = 02/04/11	CHECKED - SJP	REVISED -
	DATE - 02/04/2011	REVISED -

CITY OF ROCKFORD
MORGAN STREET BRIDGE

PROPOSED SANITARY SEWER RELOCATION
STANDARD DETAILS

SCALE: N/A SHEET NO. 5 OF 5 SHEETS STA. TO STA.

F.A. RTE.	SECTION	COUNTY	TOTAL SHEETS	SHEET NO.
5077	99-00493-00-BR	WINNEBAGO	253	114
CONTRACT NO. 85529				
FED. ROAD DIST. NO. 2 (ILLINOIS) FED. AID PROJECT BRM-5099165				