

STATE OF ILLINOIS
DEPARTMENT OF TRANSPORTATION

F.A.P. RTE.	SECTION	COUNTY	TOTAL SHEETS	SHEET NO.
330	(15X,11X-2)N,RS	KANKAKEE	13	1
		ILLINOIS	CONTRACT NO. 66L86	

INDEX OF SHEETS

- 1 COVER SHEET
- 2 GENERAL NOTES AND COMMITMENTS
- 3-5 SUMMARY OF QUANTITIES
- 6 TYPICAL SECTIONS
- 7 SCHEDULES
- 8 PLAN DETAILS
- 9 PAVEMENT MARKING DETAILS
- 10-13 DETAILS

LIST OF ILLINOIS DOT HIGHWAY STANDARDS

- 000001-08 STANDARD SYMBOLS, ABBREVIATIONS AND PATTERNS
- 001006 DECIMAL OF AN INCH AND OF A FOOT
- 701427-05 LANE CLOSURE, MULTILANE INTERMITTENT OR MOVING OPERATION, FOR SPEEDS 40 MPH
- 701601-09 URBAN LANE CLOSURE, MULTILANE, 1W OR 2W WITH NONTRAVERSABLE MEDIAN
- 701701-10 URBAN LANE CLOSURE, MULTILANE INTERSECTION
- 701901-08 TRAFFIC CONTROL DEVICES
- 780001-05 TYPICAL PAVEMENT MARKINGS

**PROPOSED
HIGHWAY PLANS**

**F.A.P. ROUTE 330 (IL-17)
SECTION (15X,11X-2)N,RS
MILLING AND RESURFACING
KANKAKEE COUNTY**

C-93-091-21

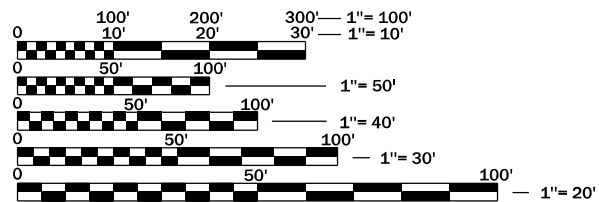
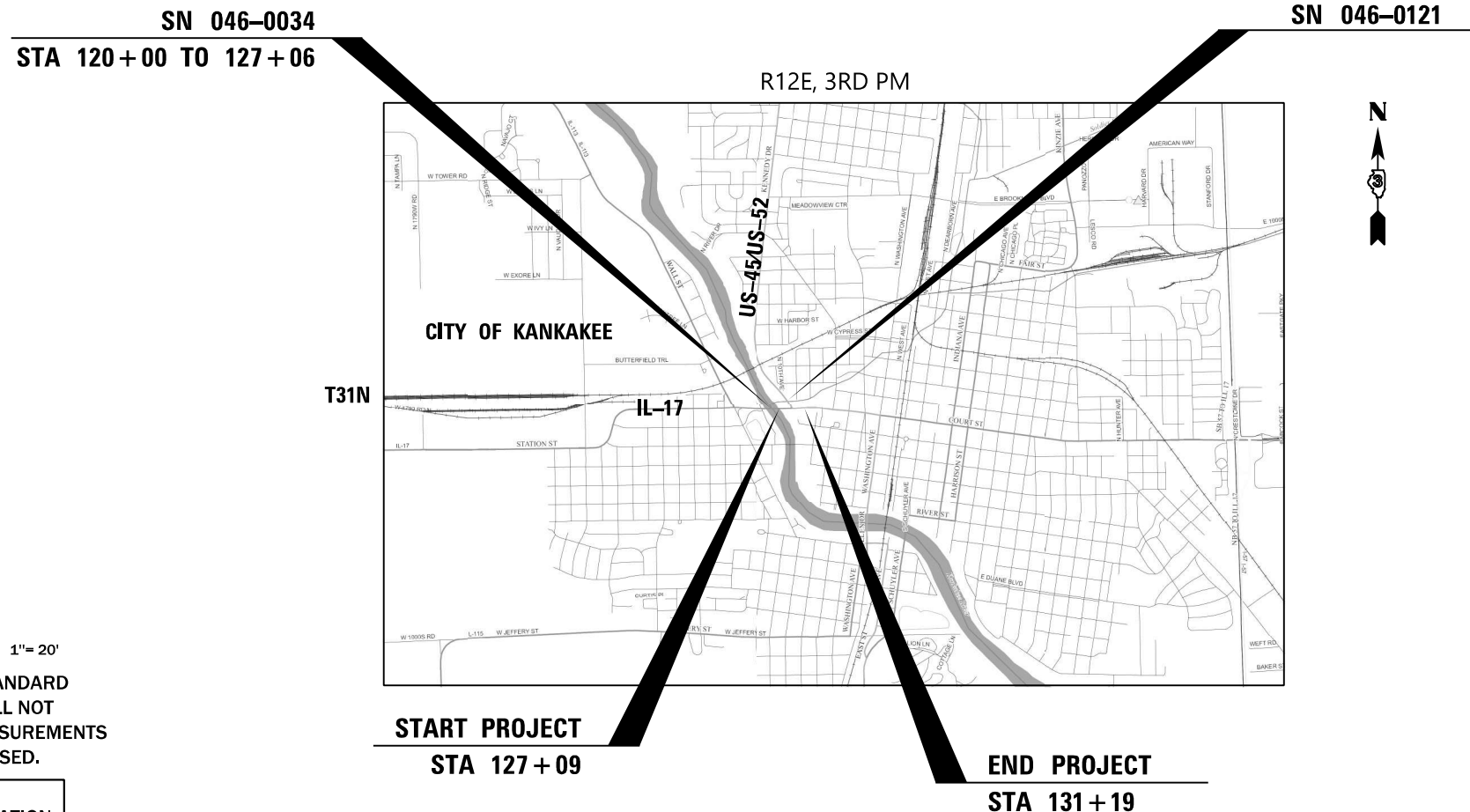

FULL SIZE PLANS HAVE BEEN PREPARED USING STANDARD ENGINEERING SCALES. REDUCED SIZED PLANS WILL NOT CONFORM TO STANDARD SCALES. IN MAKING MEASUREMENTS ON REDUCED PLANS, THE ABOVE SCALES MAY BE USED.

J.U.L.I.E.
JOINT UTILITY LOCATION INFORMATION FOR EXCAVATION
1-800-892-0123
OR 811

PROJECT ENGINEER: BRAD DUNCAN P.E.
UNIT CHIEF: LUIS CALDERON P.E.
DISTRICT 3 NO. (815) 434-6131
CONTRACT NO. 66L86

GROSS LENGTH = 410 FT. = 0.08 MILE
NET LENGTH = 410 FT. = 0.08 MILE

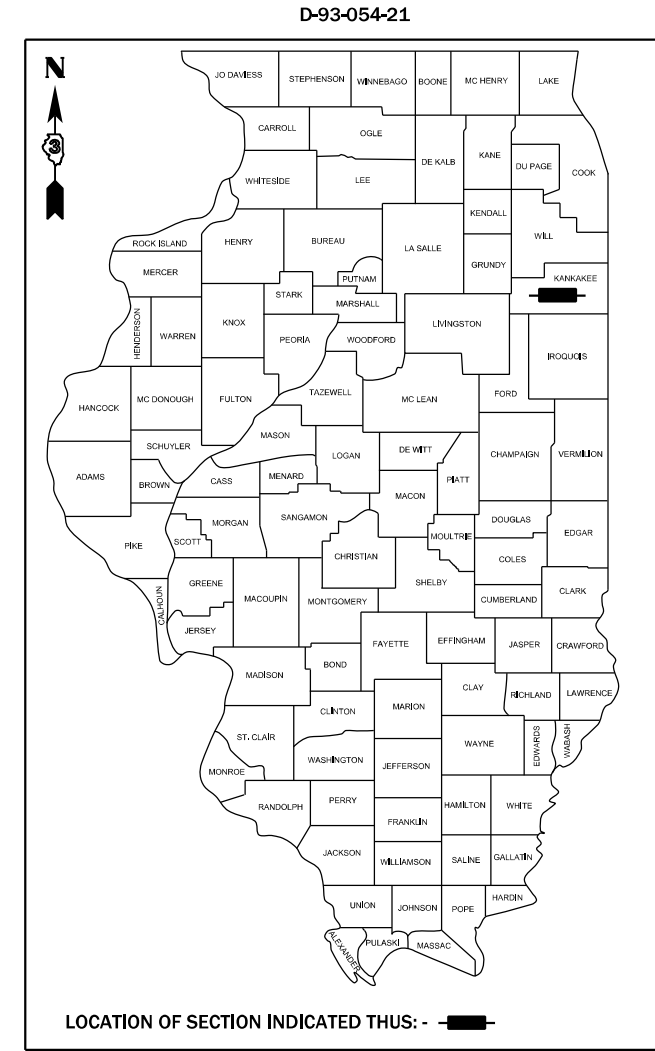

FUNCTIONAL CLASSIFICATION

PRINCIPAL ARTERIAL

2019 ADT = 13300

PV = 91.73% SU = 3.57% MU = 4.70%

STATE OF ILLINOIS
DEPARTMENT OF TRANSPORTATION

SUBMITTED March 24, 20 21

David Alwood
REGIONAL ENGINEER

May 7, 2021 *Scott A. Clark*
ENGINEER OF DESIGN AND ENVIRONMENT

May 7, 2021 *James J. Guerin*
DIRECTOR OF HIGHWAYS PROJECT IMPLEMENTATION

**PRINTED BY THE AUTHORITY
OF THE STATE OF ILLINOIS**

GENERAL NOTES

- 1) EXCEPT AS NOTED ON THE PLANS, PAVEMENT GRADES SHOWN ARE AT THE TOP OF PAVEMENT SURFACES.
- 2) THE ENGINEER WILL BE THE SOLE JUDGE CONCERNING CURING TIME FOR THE VARIOUS HMA LIFTS.
- 3) ALL EXCAVATED MATERIAL, WHICH INCLUDES DIGGING OR GRADING OF ANY SOIL OR FILL MATERIAL, WITH THE EXCEPTION OF AGGREGATE FILLS, MUST BE INCORPORATED WITHIN THE IDOT RIGHT OF WAY.
- 4) ALL ELEVATIONS REFERRING TO U.S.G.S. MEAN SEA LEVEL DATUM.
- 5) THE FOLLOWING RATES OF APPLICATION HAVE BEEN USED IN CALCULATING PLAN QUANTITIES:

HMA RESURFACING	112	LBS / SQ YD / IN
SHORT TERM PAVEMENT MARKING	10	FT /100 FT OF APPLICATION
MIX FOR CRACKS, JTS & FLGWYS	0.0003	TONS / SQ YD
BINDER (HAND METHOD)	0.0005	TONS / SQ YD

COMMITMENTS

NO COMMITMENTS

STATE OF ILLINOIS
DEPARTMENT OF TRANSPORTATION
DISTRICT THREE
AS BUILT INFORMATION

SUPERVISING CONSTRUCTION FIELD ENGINEER

RESIDENT ENGINEER / TECHNICIAN

START & END DATES
OF CONSTRUCTION:

INSPECTORS:

STATE OF ILLINOIS
DEPARTMENT OF TRANSPORTATION
DISTRICT THREE

PREPARED BY: _____
DISTRICT STUDIES & PLANS ENGINEER

DATE: _____

EXAMINED BY: _____
DISTRICT CONSTRUCTION ENGINEER

DISTRICT MATERIALS ENGINEER

DISTRICT OPERATIONS ENGINEER

**STATE OF ILLINOIS
DEPARTMENT OF TRANSPORTATION**

GENERAL NOTES

SCALE: SHEET 1 OF 1 SHEETS STA. TO STA.

F.A.P RTE.	SECTION	COUNTY	TOTAL SHEETS	SHEET NO.
330	(15X,11X-2)N,RS	KANKAKEE	13	2
CONTRACT NO. 66L86			ILLINOIS FED. AID PROJECT	

MODEL: Default
 FILE NAME: p:\pub\lancom\m.dal\illinois\pwr\DOT\Documents\DOT_Offices\District_3\Projects\0366L86\CADD\0366L86-sh-500.dgn

CODE NO.	ITEM	UNIT	TOTAL QUANTITY	CONSTR. CODE	
				STATE	100%
				ROADWAY	
				0005	URBAN
40600290	BITUMINOUS MATERIALS (TACK COAT)	POUND	564	564	
40600400	MIXTURE FOR CRACKS, JOINTS, AND FLANGEWAYS	TON	0.25	0.25	
40600906	POLYMERIZED HOT-MIX ASPHALT BINDER COURSE (HAND METHOD), N70	TON	0.42	0.42	
40600990	TEMPORARY RAMP	SQ YD	265	265	
40603235	POLYMERIZED HOT-MIX ASPHALT BINDER COURSE, 1L-19.0, N70	TON	106	106	
40604162	POLYMERIZED HOT-MIX ASPHALT SURFACE COURSE, 1L-9.5, MIX "D", N70	TON	71	71	
44000164	HOT-MIX ASPHALT SURFACE REMOVAL, 3 3/4"	SQ YD	837	837	
67100100	MOBILIZATION	L SUM	1	1	
70102630	TRAFFIC CONTROL AND PROTECTION, STANDARD 701601	L SUM	1	1	
70102635	TRAFFIC CONTROL AND PROTECTION, STANDARD 701701	L SUM	1	1	
70200100	NIGHTTIME WORK ZONE LIGHTING	L SUM	1	1	
70300100	SHORT TERM PAVEMENT MARKING	FOOT	93	93	
70300150	SHORT TERM PAVEMENT MARKING REMOVAL	SQ FT	21	21	
* 78000100	THERMOPLASTIC PAVEMENT MARKING - LETTERS AND SYMBOLS	SQ FT	150	150	

*** SPECIALTY ITEMS**

USER NAME = ZAGARIK DESIGNED - DRAWN - PLOT SCALE = 100.0000' / in. CHECKED - DATE - PLOT DATE = 3/22/2021 REVISED - REVISED - REVISED - REVISED -	STATE OF ILLINOIS DEPARTMENT OF TRANSPORTATION	SUMMARY OF QUANTITIES	F.A.P. RTE. 330 SECTION (15X,11X-2)N,RS COUNTY KANKAKEE TOTAL SHEETS 13 SHEET NO. 3 CONTRACT NO. 66L86 ILLINOIS FED. AID PROJECT
SCALE:	SHEET 1 OF 3 SHEETS	STA. TO STA.	

CODE NO.	ITEM	UNIT	TOTAL QUANTITY	CONSTR. CODE	
				STATE 100%	
				ROADWAY	
				0005	URBAN
* 78000200	THERMOPLASTIC PAVEMENT MARKING - LINE 4"	FOOT	448	448	
* 78000400	THERMOPLASTIC PAVEMENT MARKING - LINE 6"	FOOT	148	148	
* 78000500	THERMOPLASTIC PAVEMENT MARKING - LINE 8"	FOOT	1005	1005	
* 78000600	THERMOPLASTIC PAVEMENT MARKING - LINE 12"	FOOT	310	310	
* 78003130	PREFORMED PLASTIC PAVEMENT MARKING, TYPE B - LINE 6"	FOOT	436	436	
* 78003180	PREFORMED PLASTIC PAVEMENT MARKING, TYPE B - LINE 24"	FOOT	138	138	
* 78100100	RAISED REFLECTIVE PAVEMENT MARKER	EACH	6	6	
	78300200 RAISED REFLECTIVE PAVEMENT MARKER REMOVAL	EACH	6	6	
	78300202 PAVEMENT MARKING REMOVAL - WATER BLASTING	SQ FT	1622	1622	
* X7830060	GROOVING FOR RECESSED PAVEMENT MARKING, LETTERS AND SYMBOLS	SQ FT	164	164	
* X7830070	GROOVING FOR RECESSED PAVEMENT MARKING 5"	FOOT	448	448	
* X7830074	GROOVING FOR RECESSED PAVEMENT MARKING 7"	FOOT	330	330	
* X7830076	GROOVING FOR RECESSED PAVEMENT MARKING 9"	FOOT	887	887	
* X7830090	GROOVING FOR RECESSED PAVEMENT MARKING 25"	FOOT	73	73	

*** SPECIALTY ITEMS**

MODEL: Default
 FILE NAME: p:\pub\lanscom\data\illinois\pwr\DOT\Documents\DOT Offices\District 3\Projects\0366L86\CADD\0366L86-sh-5002.dgn

USER NAME = ZAGARIK	DESIGNED -	REVISED -	STATE OF ILLINOIS DEPARTMENT OF TRANSPORTATION	SUMMARY OF QUANTITIES			F.A.P RTE.	SECTION	COUNTY	TOTAL SHEETS	SHEET NO.			
PLOT SCALE = 100.0000' / in.	DRAWN -	REVISED -		SCALE:	SHEET 2	OF 3	SHEETS	STA.	TO STA.	330	(15X,11X-2)N,RS	KANKAKEE	13	4
PLOT DATE = 3/22/2021	CHECKED -	REVISED -		ILLINOIS FED. AID PROJECT										
	DATE -	REVISED -		CONTRACT NO. 66L86										

CONSTR. CODE
STATE 100%
ROADWAY
0005
URBAN

CODE NO.	ITEM	UNIT	TOTAL QUANTITY	CONSTR. CODE
Z0030850	TEMPORARY INFORMATION SIGNING	SQ FT	63	63

*** SPECIALTY ITEMS**

Model: Default
 File Name: p:\publancom\data\Illinois\proj\DOT Documents\DOT Offices\District 3\Projects\0366L86\CADD\03\0366L86-sh-500.dgn

USER NAME = ZAGARIK	DESIGNED -	REVISED -
PLOT SCALE = 100.0000 ' / in.	CHECKED -	REVISED -
PLOT DATE = 3/22/2021	DATE -	REVISED -

**STATE OF ILLINOIS
 DEPARTMENT OF TRANSPORTATION**

SUMMARY OF QUANTITIES

SCALE: SHEET 3 OF 3 SHEETS STA. TO STA.

F.A.P RTE.	SECTION	COUNTY	TOTAL SHEETS	SHEET NO.
330	(15X,11X-2)N,RS	KANKAKEE	13	5
CONTRACT NO. 66L86			ILLINOIS FED. AID PROJECT	

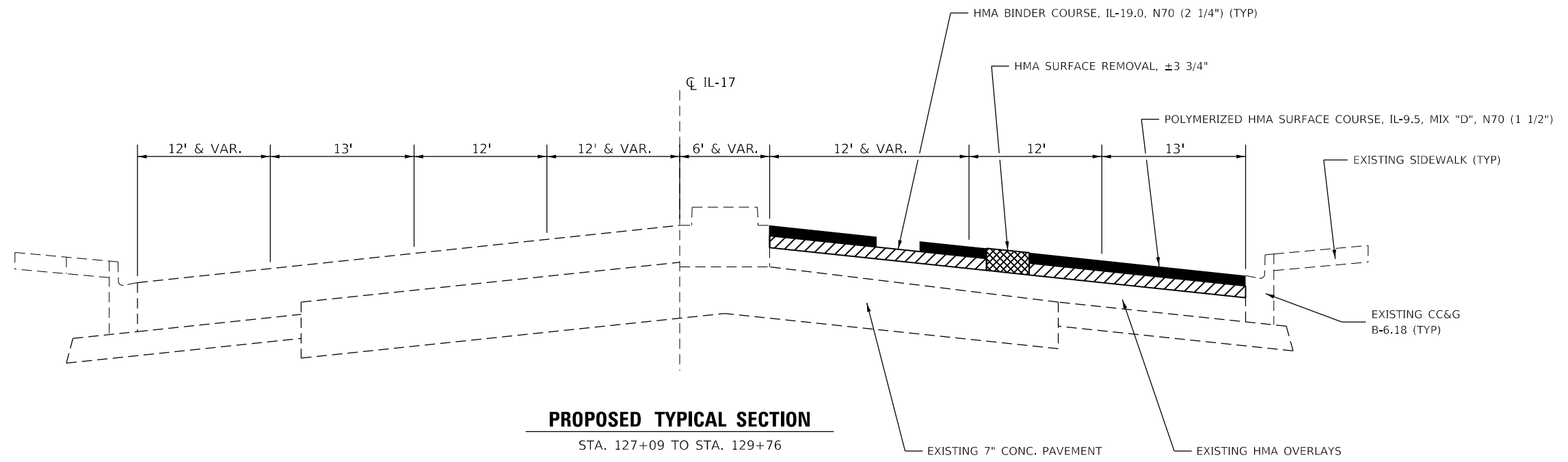

HMA MIXTURE REQUIREMENT TABLE

LOCATIONS:	ENTIRE PROJECT	ENTIRE PROJECT
MIXTURE USE(S):	HMA	HMA
	BINDER	SURFACE
BINDER GRADE (PG):	SBS PG70-28	SBS PG70-28
DESIGN AIR VOIDS:	4.0% @ N70	4.0% @ N70
MIXTURE COMPOSITION: (MIXTURE GRADATION)	IL 19.0	IL 9.5
FRICTION AGGREGATE:		MIXTURE D
MIXTURE WEIGHT:	112.0 LB/SY/IN	112.0 LB/SY/IN
QUALITY MANAGEMENT PROGRAM:	QCQA	QCQA
SUBLOT SIZE:	NA	NA
DENSITY TEST METHOD:	CORES	CORES

MODEL: Default
 FILE: \\mdele-prod\pub\arcom\usd\illinois\p\p\DOT\Documents\DOT-Office\District_3\Projects\0366\06\CADD\0366_06_sht-typrcal.dgn

USER NAME = ZAGARIK	DESIGNED -	REVISED -
PLOT SCALE = 100.0000' / in.	DRAWN -	REVISED -
PLOT DATE = 3/15/2021	CHECKED -	REVISED -
	DATE -	REVISED -

**STATE OF ILLINOIS
DEPARTMENT OF TRANSPORTATION**

TYPICAL SECTIONS

SCALE: SHEET 1 OF 1 SHEETS STA. TO STA.

F.A.P RTE.	SECTION	COUNTY	TOTAL SHEETS	SHEET NO.
330	(15X,11X-2)N,RS	KANKAKEE	13	6
CONTRACT NO. 66L86				
ILLINOIS FED. AID PROJECT				

MAINLINE SCHEDULE												
LOCATION			LENGTH	MAINLINE WIDTH	AREA	HMA SURF REM 3 3/4" (MAINLINE)	P HMA BC HM N70	P HMA BC IL-19.0 N70 (2.25")	P HMA SURF CSE IL-9.5 MIX D N70 (1.5")	MIX JTS, CRACKS & FLGWYS	BIT MAT'L TACK COAT	TEMP RAMP
STA TO	STA	FOOT	FOOT	SQ YD	SQ YD	TONS	TONS	TONS	TON	POUND	SQ YD	
127+32	TO 128+99	167	25	460	460	0.23	58	39	0.14	310	220	
128+99	TO 129+76	77	37-50	377	377	0.19	48	32	0.11	254	45	
TOTAL		244		837	837	0.42	106	71	0.25	564	265	

SHORT TERM PMK & RAISED REFLECTOR SCHEDULE						
LOCATION			LENGTH	RAISED REFL PVMT MARKERS INSTALL ONE-WAY CRYSTAL	RAISED REFLECTIVE MARKERS REMOVAL	SHORT TERM* PAVT MARKING INSTALL (3 APP) REMOVE (2 APP)
STA TO	STA	FOOT	FOOT	EACH	EACH	FOOT SQ FT
127+09	TO 128+99	190				57 13
128+99	TO 129+76	77		6	6	36 8
TOTAL		267		6	6	93 21

*SHORT TERM PAVEMENT MARKING SHALL BE CONFINED TO MILLING AND RESURFACING LIMITS.

PAVEMENT MARKING SCHEDULE																
LOCATION			LENGTH	THERMOPLASTIC PMK					PREF PL PMK TY B		GRV RCSD PVT MRKG					PAVT MARKING REMOVAL WATER BLASTING*
STA TO	STA	FOOT	4" YELLOW MEDIAN EDGE	6" WHITE SKIPS	8" WHITE TURN LANES	12" WHITE ISLAND	12" WHITE DIAG	LTR & SYM	6" WHITE CROSSWALK	24" WHITE STOP BAR	5"	7"	9"	25"	LTR & SYM	SQ FT
IL-17 COURT ST																
127+09	TO 129+76	267	157	74	256	286	183	50	184	98	157	257	542	73**	55	746
129+76	TO 131+26	150	291	73	298			100			291	73	298		110	432
IL-17 COURT ST TOTAL		417	448	148	840		183	150	184	98	448	330	840	73	164	1,179
US-45/52 KENNEDY DR																
59+08	TO 60+13	105			37	129	127		252	40			47			443
US-45/52 KENNEDY DR		105			166		127		252	40			47			443
GRAND TOTAL		522	448	148	1,005		310	150	436	138	448	330	887	73	164	1,622

* PAVEMENT MARKING WATER BLASTING SHALL EXCLUDE THE AREA WITHIN MILLING & RESURFACING LIMITS

** STOP BAR AT STA 127+26 IN EB THROUGH LANES ON PCC SURFACE SHALL NOT BE GROOVED. EB TURNING LANES AT STA 127+26 ON HMA SURFACE SHALL BE GROOVED.

PERMANENT SURVEY MARKER AND MONUMENT TABLE					
MONUMENT NUMBER	DESCRIPTION	EXISTING MONUMENT TYPE	PROPOSED MONUMENT TYPE	MONUMENT RECORD TO BE RECORDED	RESPONSIBILITY
N/A	NO SURVEY CONTROL OR SECTION CORNER PERMANENT MARKERS REQUIRED, AS DESIGNED.	N/A	N/A	N/A	N/A
NO KNOWN SURVEY OR CENTERLINE CONTROL MONUMENTS ARE ON THE ROAD SURFACE THAT WILL BE DISTURBED BY THE MILLING AND RESURFACING AS DESIGNED. PERMANENT SURVEY MARKERS EXIST NEARBY. IF JOB LIMITS ARE REVISED DURING CONSTRUCTION, R.E. WILL DIRECT PLATS AND PLANS SURVEYORS TO GPS ANY MARKER SUBJECT TO DESTRUCTION, AND INFORM THEM TO STAKE THE LOCATION FOR CORING UPON JOB COMPLETION. NO MONUMENT RECORDS ARE REQUIRED FOR THIS JOB.					

MOBILE: Default
 FILE NAME: p:\pub\barcom\dat\illinois\pvt\DOT\Documents\DOT\Office\Dist\ct_3\Projects\0366\06\CADD\0366\06-shr-schedule.dgn

USER NAME = ZAGARIK	DESIGNED -	REVISED -
	DRAWN -	REVISED -
PLOT SCALE = 100,0000 ' / in.	CHECKED -	REVISED -
PLOT DATE = 3/24/2021	DATE -	REVISED -

STATE OF ILLINOIS
DEPARTMENT OF TRANSPORTATION

SCHEDULES			
SCALE:	SHEET 1	OF 1	SHEETS
STA.	TO STA.		

F.A.P RTE.	SECTION	COUNTY	TOTAL SHEETS	SHEET NO.
330	(15X,11X-2)N,RS	KANKAKEE	13	7
CONTRACT NO. 66L86				
ILLINOIS FED. AID PROJECT				

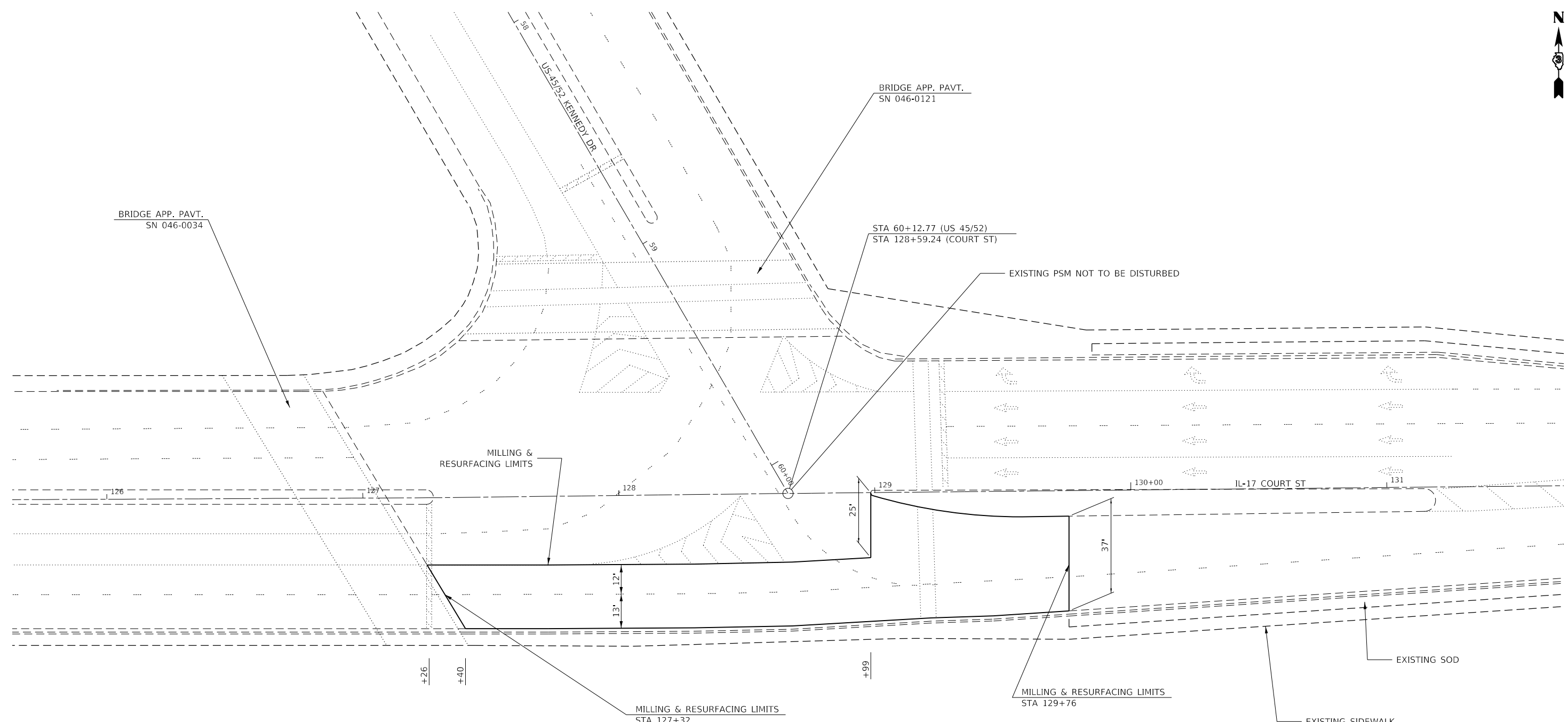

MODEL: Default
 FILE NAME: p:\planning\commodat\illinois\pwr\DOT\Documents\DOT_Offices\District_3\Projects\0366\06\CADD\0366_06_sch.dwg

USER NAME = ZAGARIK	DESIGNED -	REVISED -
DRAWN -	REVISED -	
PLOT SCALE = 40,0000 ' / in.	CHECKED -	REVISED -
PLOT DATE = 3/19/2021	DATE -	REVISED -

**STATE OF ILLINOIS
DEPARTMENT OF TRANSPORTATION**

IL 17 (COURT ST) PLAN DETAILS

SCALE: SHEET 1 OF 1 SHEETS STA. TO STA.

F.A.P. RTE.	SECTION	COUNTY	TOTAL SHEETS	SHEET NO.
330	(15X,11X-2)N,RS	KANKAKEE	13	8
CONTRACT NO. 66L96				
ILLINOIS FED. AID PROJECT				

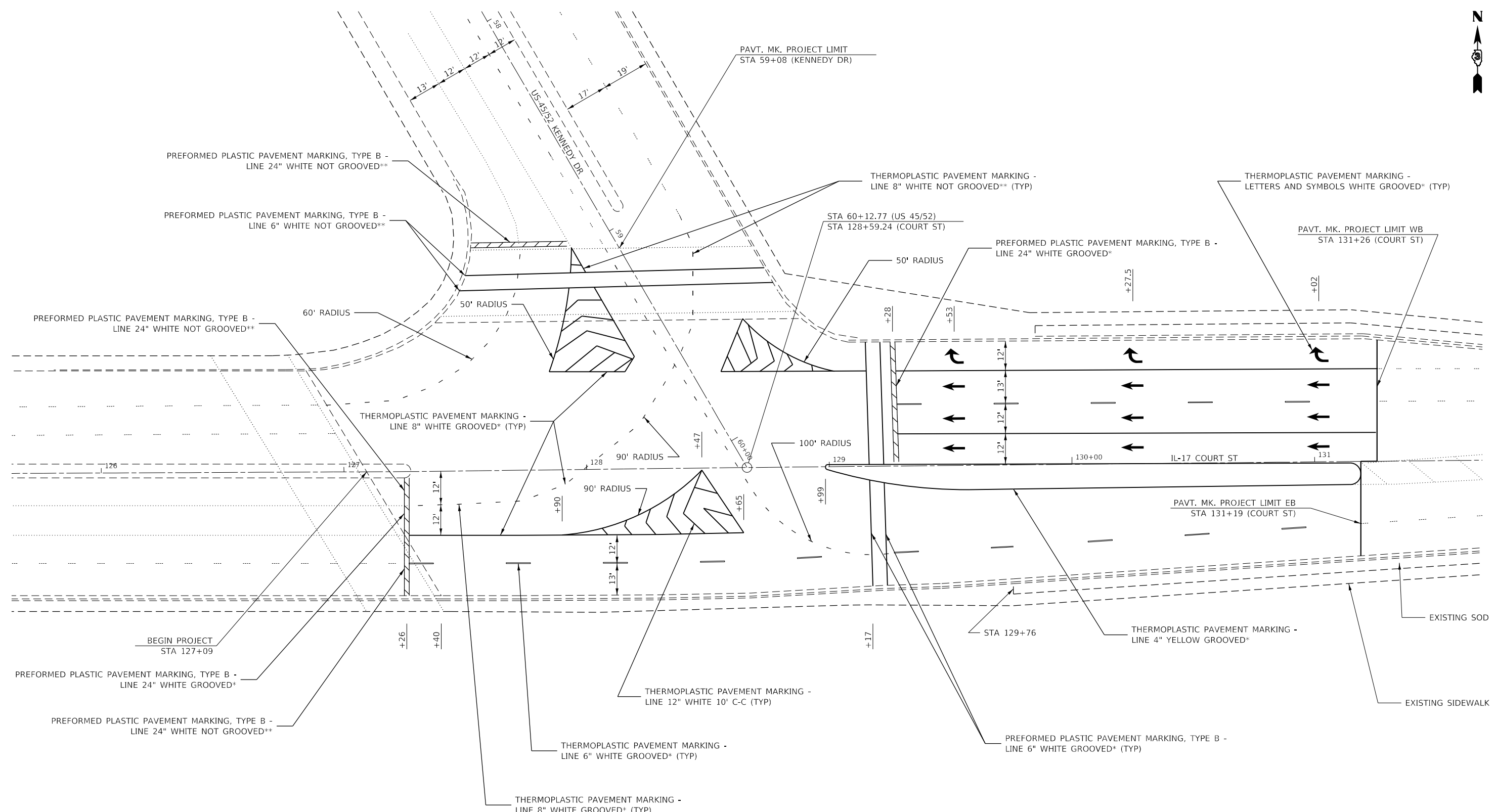

*PAVEMENT MARKINGS TO BE GROOVED LIMITED TO HMA SURFACE
 PREFORMED PLASTIC TYPE B MATERIAL
 6" CROSSWALK LINES
 24" STOP LINES
 THERMOPLASTIC PAVEMENT MARKINGS
 4" YELLOW MEDIAN
 6" WHITE SKIP DASH
 8" WHITE TURN DASH
 8" WHITE ISLAND
 LETTERS & SYMBOLS
 ** PAVEMENT MARKINGS ON PCC SURFACE WILL REMAIN UNGROOVED.

MODEL: Default
 FILE: Name: p:\pub\barcom\data\illinois\pav\pww\DOT\Documents\DOT_Offices\District_3\Projects\1366186\1366186-shc-spm.dgn

USER NAME = ZAGARIK	DESIGNED -	REVISED -
	DRAWN -	REVISED -
PLOT SCALE = 40.0000' / in.	CHECKED -	REVISED -
PLOT DATE = 3/18/2021	DATE -	REVISED -

**STATE OF ILLINOIS
DEPARTMENT OF TRANSPORTATION**

PAVEMENT MARKING DETAILS

SCALE: SHEET 1 OF 1 SHEETS STA. TO STA.

F.A.P. RTE.	SECTION	COUNTY	TOTAL SHEETS	SHEET NO.
330	(15X,11X-2)N,RS	KANKAKEE	13	9
CONTRACT NO. 66L96			ILLINOIS FED. AID PROJECT	

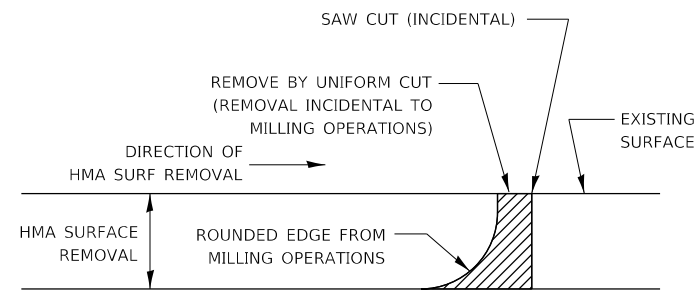

NOTE:
 WHEN MILLING OPERATIONS PRODUCE A ROUNDED EDGE,
 THEN A SAW CUT SHALL BE USED TO MANUFACTURE
 A PERPENDICULAR EDGE AS SHOWN IN THE DETAIL.
 THE ENGINEER SHALL BE THE SOLE JUDGE
 CONCERNING THE USE OF THIS DETAIL

HMA DETAIL AT BUTT JOINTS

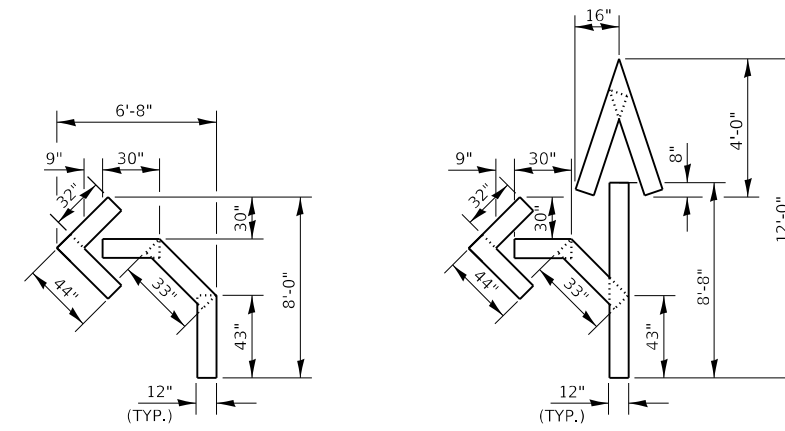

QUANTITY
 12" LINE = 16 LIN FT
 OR 4" LINE = 48 LIN FT

QUANTITY
 12" LINE = 29 LIN FT
 OR 4" LINE = 87 LIN FT

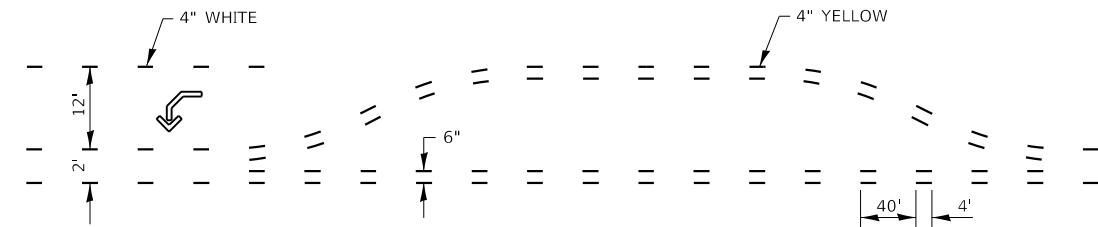

SHORT-TERM PAVEMENT MARKING FOR MEDIANS AND ARROWS

MODEL: Default
 FILE NAME: p:\publanroom\dat\illinois\pww\DOT\Documents\DOT_Offices\District_3\Projects\0366\06\CADD\0366_06_sht-01.tbl.dgn

USER NAME = ZAGARIK	DESIGNED -	REVISED -
	DRAWN -	REVISED -
PLOT SCALE = 100.0000' / in.	CHECKED -	REVISED -
PLOT DATE = 3/15/2021	DATE -	REVISED -

**STATE OF ILLINOIS
 DEPARTMENT OF TRANSPORTATION**

DETAILS

SCALE: SHEET 1 OF 4 SHEETS STA. TO STA.

F.A.P. RTE.	SECTION	COUNTY	TOTAL SHEETS	SHEET NO.
330	(15X,11X-2)N,RS	KANKAKEE	13	10
CONTRACT NO. 66L86				
ILLINOIS FED. AID PROJECT				

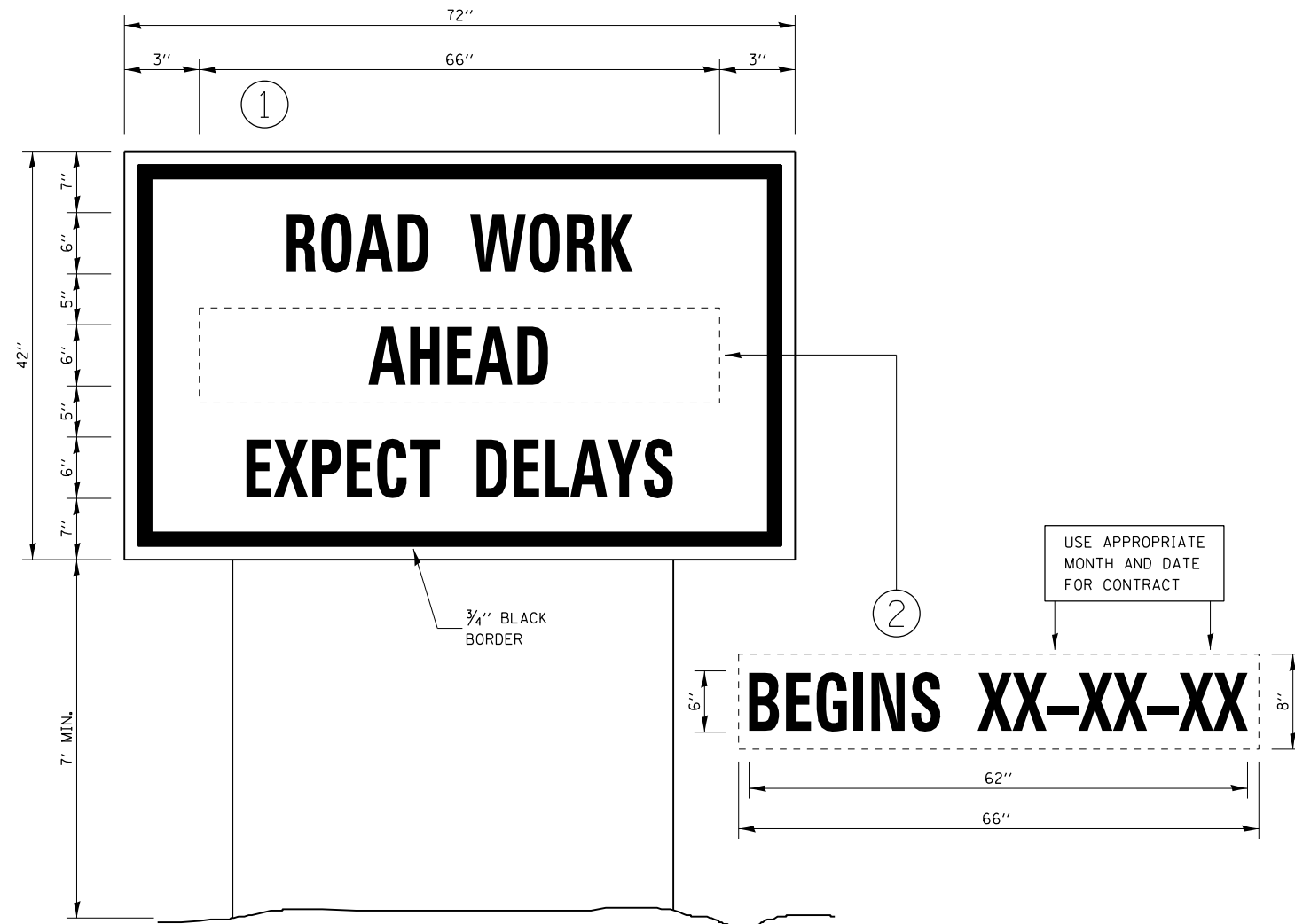

TEMPORARY INFORMATION SIGNING

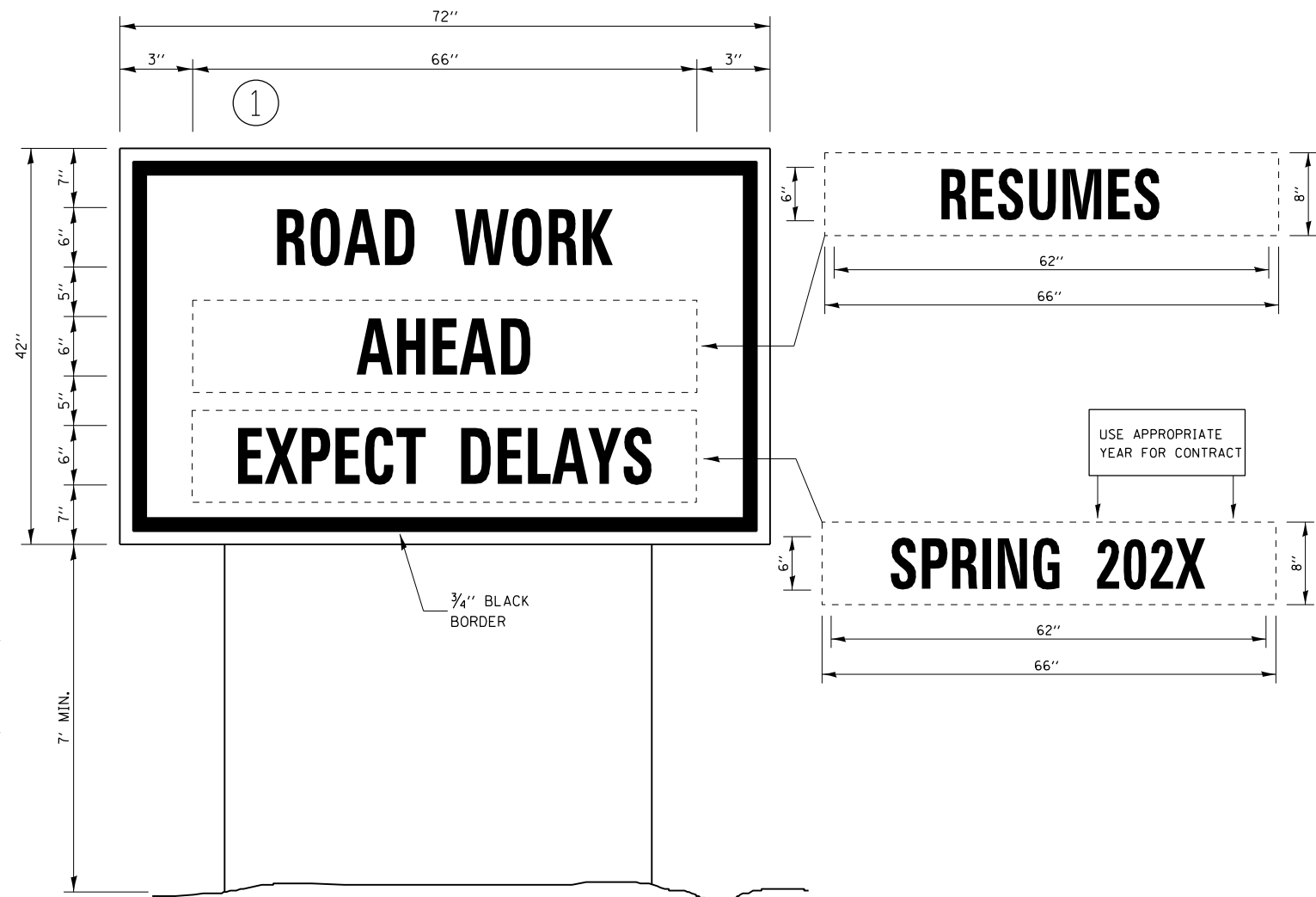

WINTER SHUT DOWN SIGNING

NOTES:

1. USE 6" D BLACK LETTERING ON FLOURESENT ORANGE BACKGROUND.
2. ERECT SIGNS AT LOCATIONS IN ADVANCE OF THE "ROAD CONSTRUCTION AHEAD" SIGNS AS DIRECTED BY THE ENGINEER.
3. ERECT SIGN ① WITH INSTALLED PANEL ② A MINIMUM OF ONE WEEK PRIOR TO THE START OF THE LANE CLOSURE.
4. REMOVE PANEL ② ON THAT DATE.
5. SEE SPECIAL PROVISION "TEMPORARY INFORMATION SIGNING" FOR ADDITIONAL INFORMATION.
6. WILL BE PAID FOR PER SQ FT AS "TEMPORARY INFORMATION SIGNING". EACH SIGN = 21 SQ FT AND THE DATE PANEL ② WILL NOT BE MEASURED SEPARATELY FOR PAYMENT.

MODEL: Default
 FILE NAME: p:\pub\barcom\mod\illinois\pwr\WDDOT\Documents\DOT Offices\District 3\Projects\0366\06\CADD\0366_06_sht-ctb\0366.dgn

USER NAME = ZAGARIK	DESIGNED -	REVISED -
	DRAWN -	REVISED -
PLOT SCALE = 100,0000' / in.	CHECKED -	REVISED -
PLOT DATE = 3/15/2021	DATE -	REVISED -

**STATE OF ILLINOIS
DEPARTMENT OF TRANSPORTATION**

DETAILS

SCALE: SHEET 2 OF 4 SHEETS STA. TO STA.

F.A.P RTE.	SECTION	COUNTY	TOTAL SHEETS	SHEET NO.
330	(15X,11X-2)N,RS	KANKAKEE	13	11
CONTRACT NO. 66L86			ILLINOIS FED. AID PROJECT	

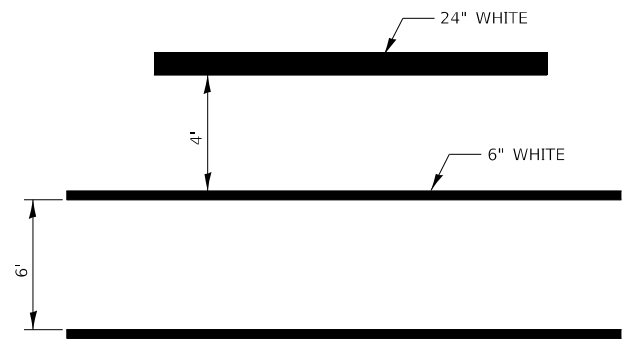

TYPICAL SPACING DETAIL FOR CROSSWALKS AND STOP BARS

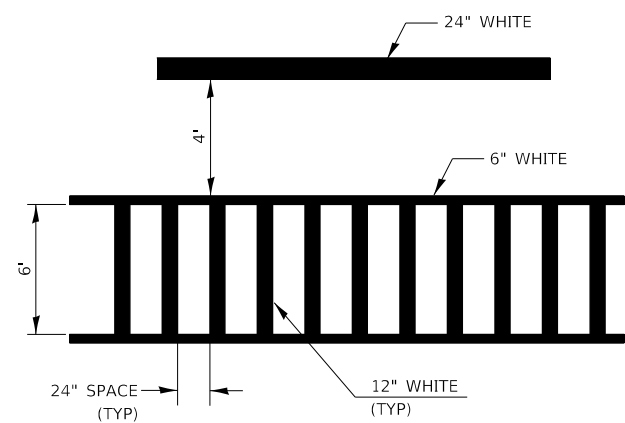

TYPICAL SPACING DETAIL FOR CROSSWALKS AND STOP BARS

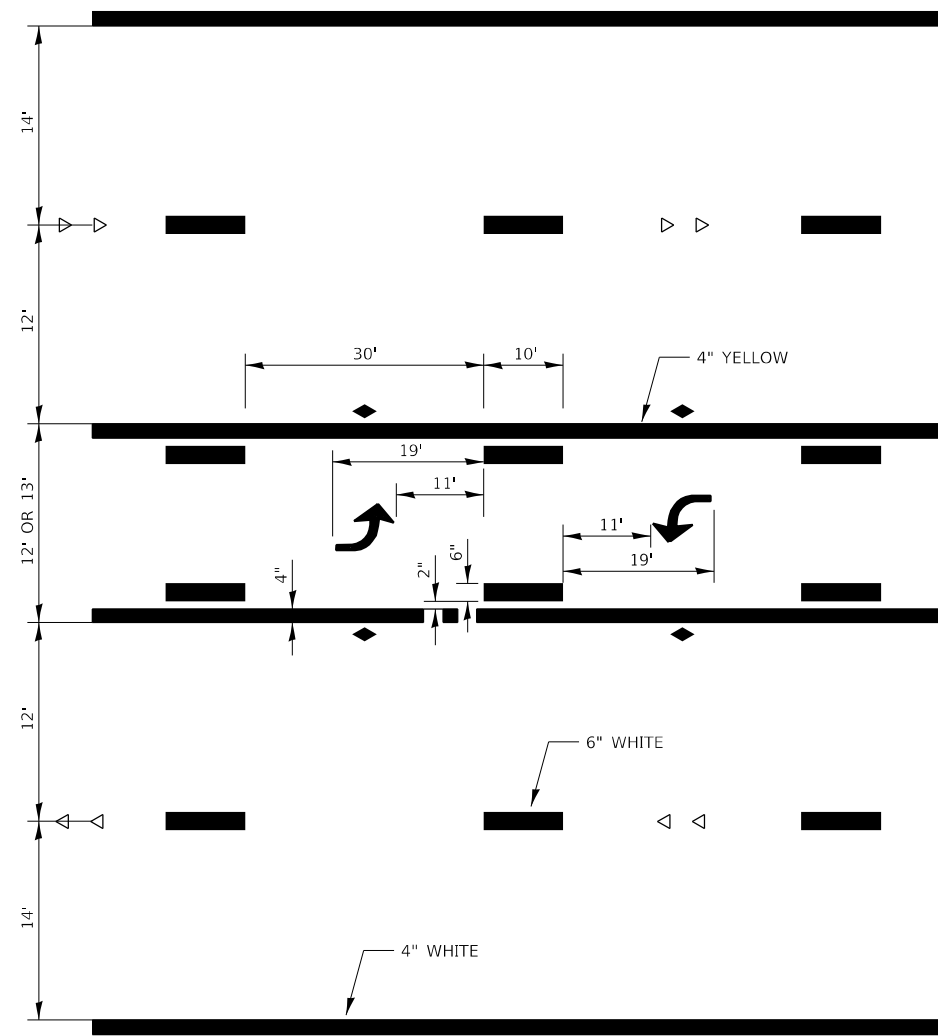

TYPICAL APPLICATION @ TWO WAY LEFT TURN LANE (TWLTL)

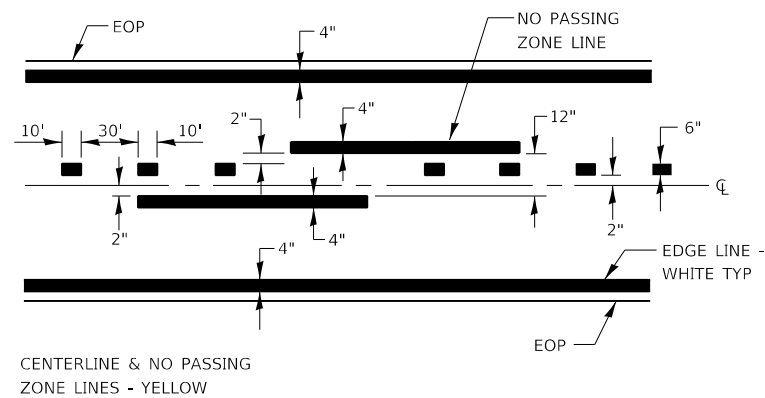

PAVEMENT MARKING

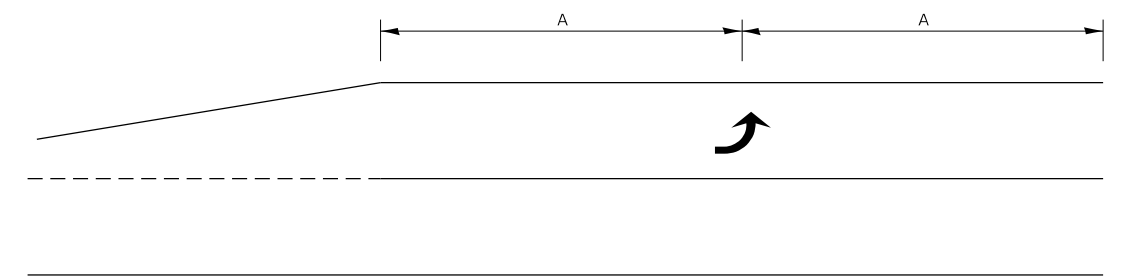

99' AND UNDER

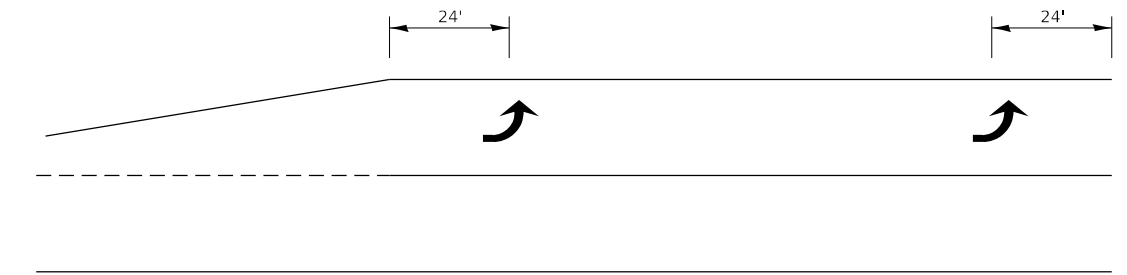

100' TO 149'

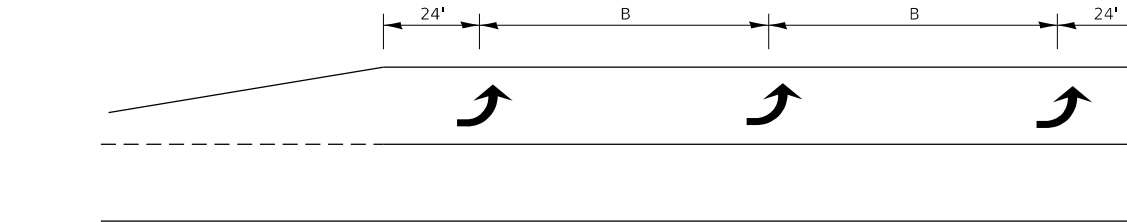

150' AND LONGER

TYPICAL PLACEMENT OF ARROWS IN TURN LANES

URBAN PAVEMENT MARKING

MODEL: Default
FILE NAME: p:\pub\barcom\m.dal\Illinois\p\WIDOT\Documents\DOT_Offices\District_3\Projects\1366186\CADD\1366186-shc-drawings.dgn

USER NAME = ZAGARIK	DESIGNED -	REVISED -
DRAWN -	REVISOR -	REVISOR -
PLOT SCALE = 100,0000' / in.	CHECKED -	REVISOR -
PLOT DATE = 3/15/2021	DATE -	REVISOR -

**STATE OF ILLINOIS
DEPARTMENT OF TRANSPORTATION**

DETAILS

SCALE: SHEET 3 OF 4 SHEETS STA. TO STA.

F.A.P RTE.	SECTION	COUNTY	TOTAL SHEETS	SHEET NO.
330	(15X,11X-2)N,RS	KANKAKEE	13	12
CONTRACT NO. 66L86				
ILLINOIS FED. AID PROJECT				

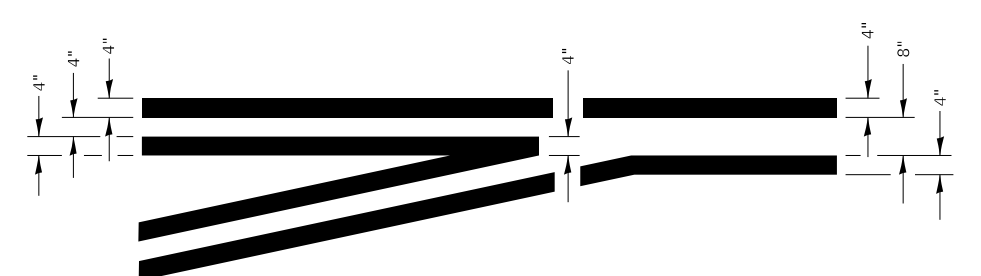
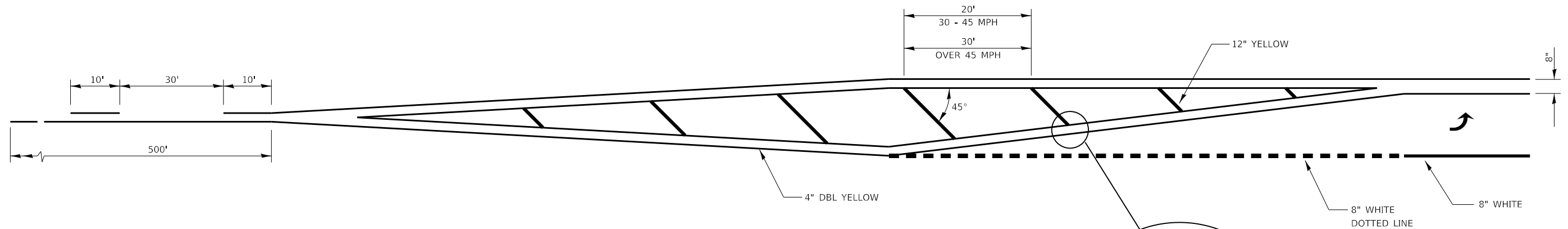

**TYPICAL APPLICATION
@ LEFT TURN LANES**

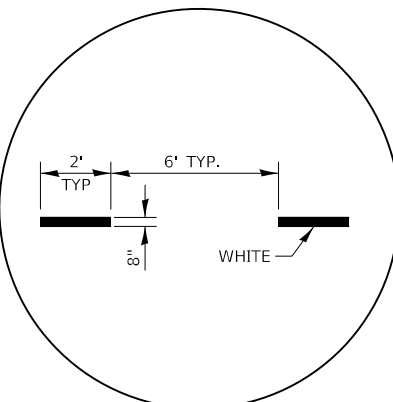
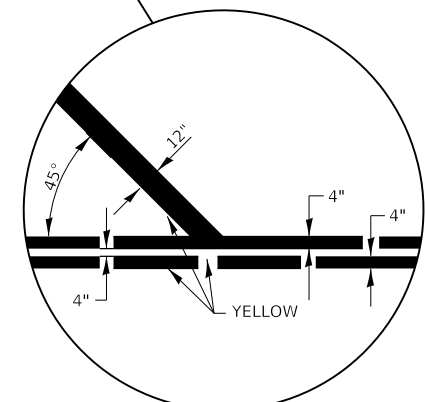

**ADVANCE AND INTERSECTION LANE
DIVIDER LINES**

URBAN PAVEMENT MARKING

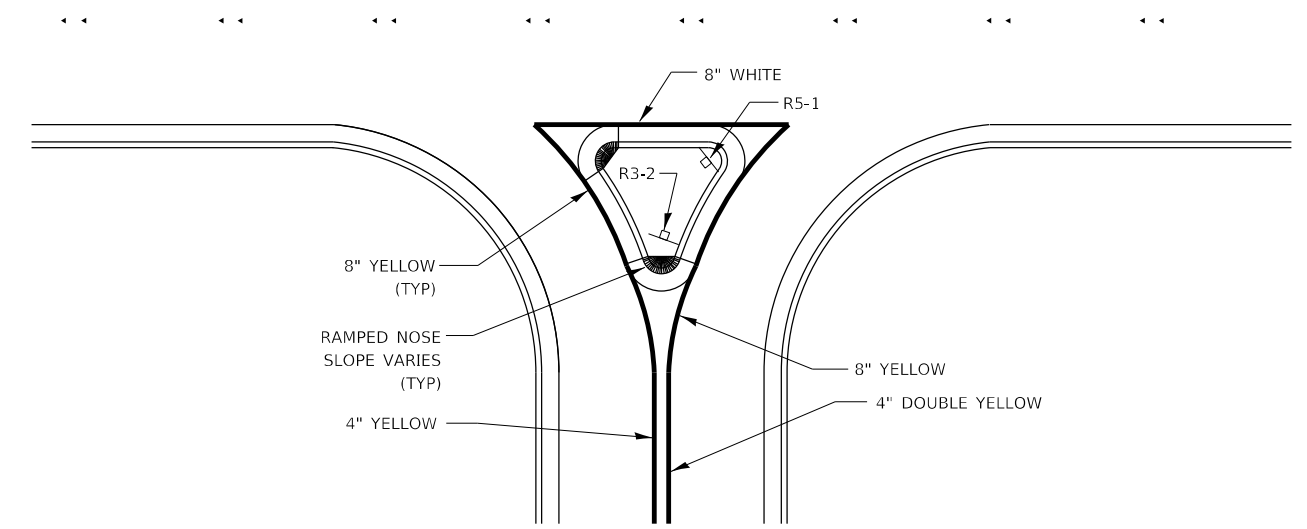

RIGHT IN RIGHT OUT ACCESS PAVEMENT MARKING

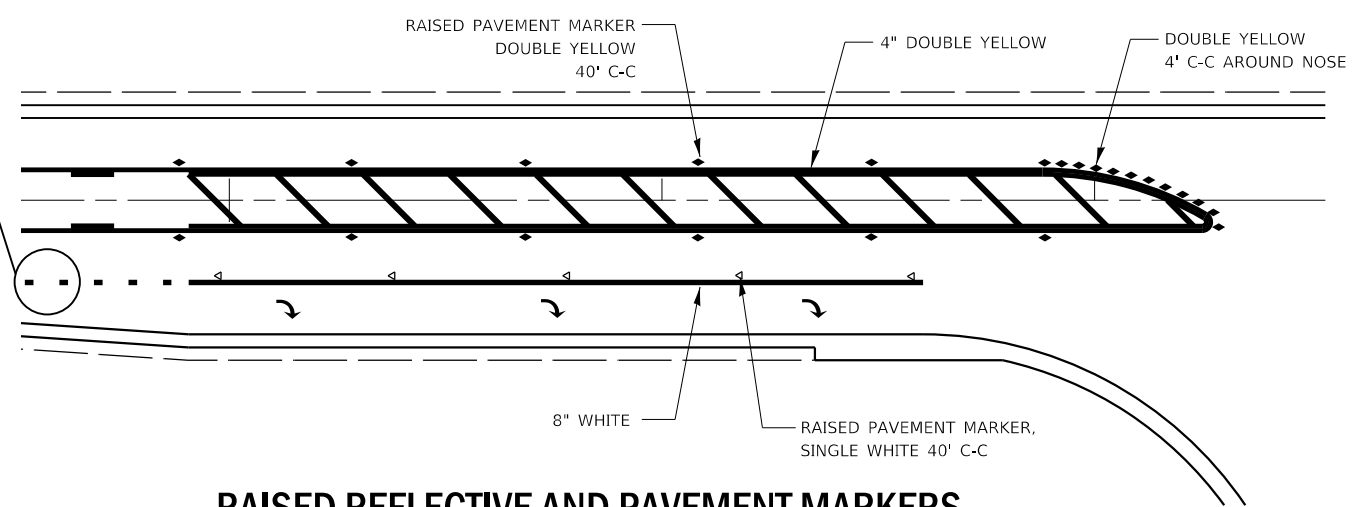

**RAISED REFLECTIVE AND PAVEMENT MARKERS
@ RIGHT TURN LANE**

MODEL: Default
 FILE: M:\M&E_Plan\pavmark.dwg
 I:\projects\11111111\DOT\Office\Drawings\11111111\DOT\11111111\11111111\11111111.dwg

USER NAME = ZAGARIK	DESIGNED -	REVISED -
	DRAWN -	REVISED -
PLOT SCALE = 100,0000' / in.	CHECKED -	REVISED -
PLOT DATE = 3/15/2021	DATE -	REVISED -

**STATE OF ILLINOIS
DEPARTMENT OF TRANSPORTATION**

DETAILS			
SCALE:	SHEET 1	OF 4 SHEETS	STA. TO STA.

F.A.P. RTE.	SECTION	COUNTY	TOTAL SHEETS	SHEET NO.
330	(15X,11X-2)N,RS	KANKAKEE	13	13
CONTRACT NO. 66L86				
ILLINOIS FED. AID PROJECT				