

PLAN

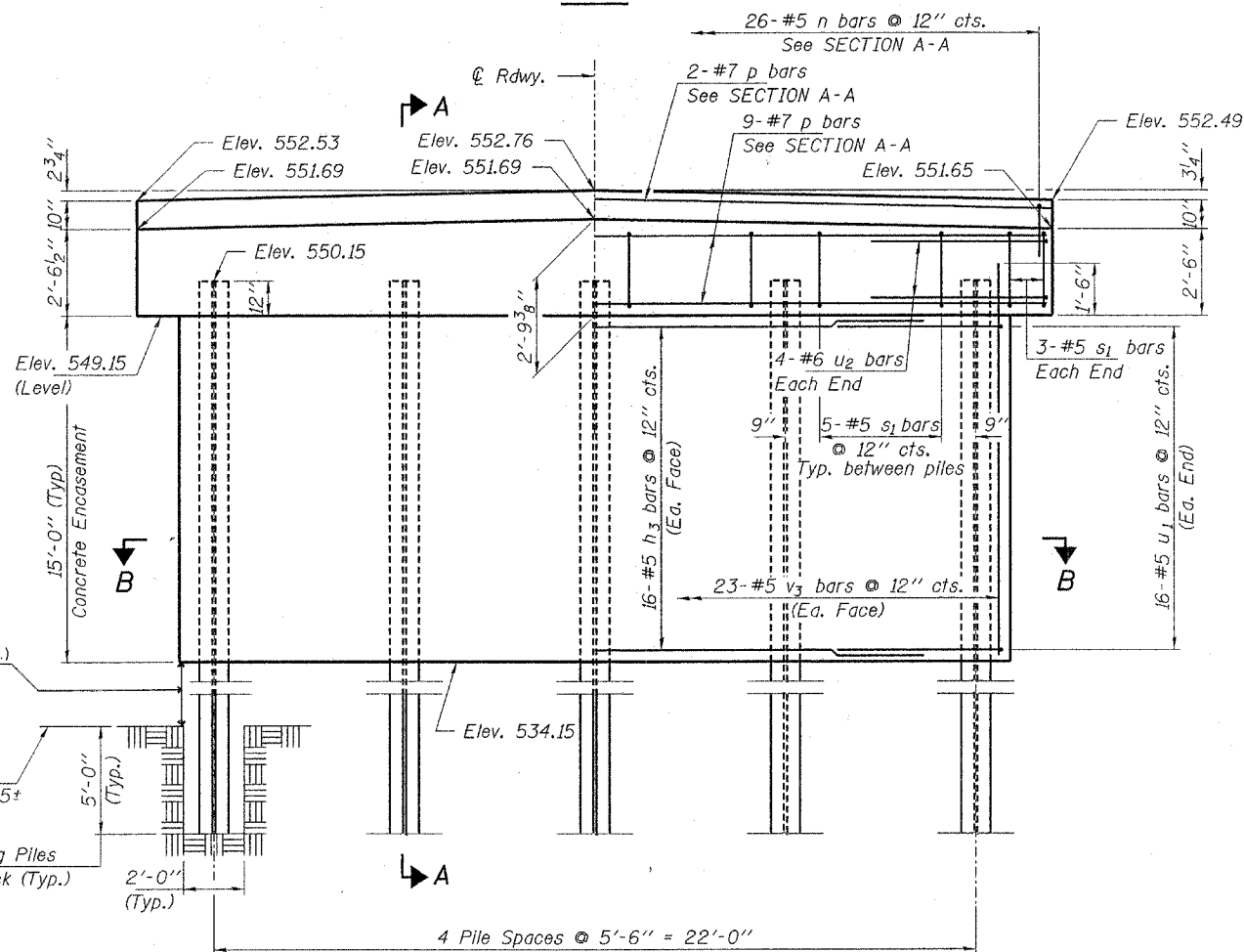

ELEVATION
(Looking East)

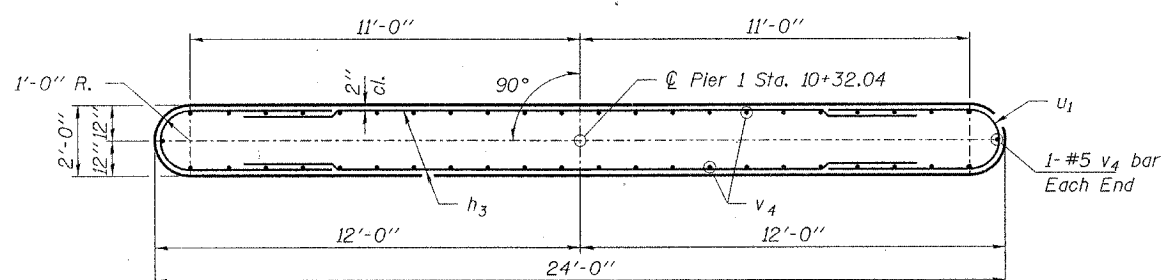

SECTION B-B

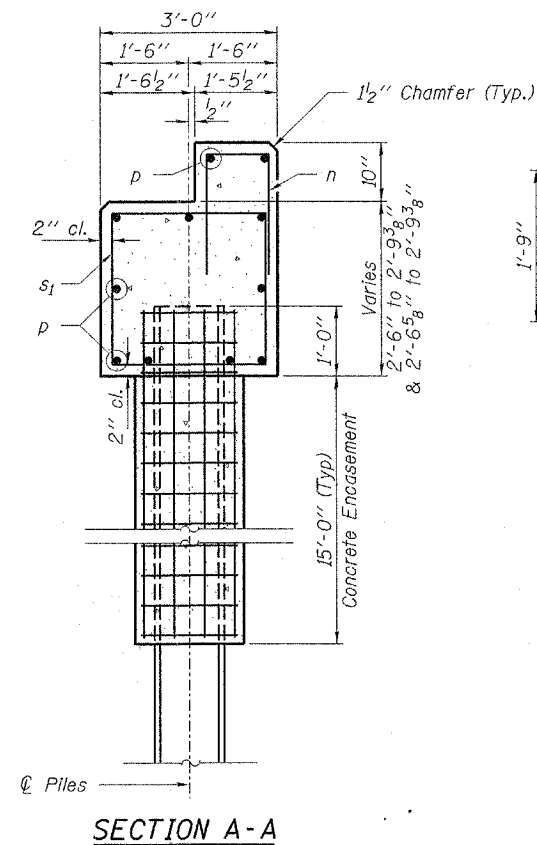

SECTION A-A

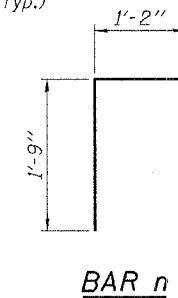

BAR n

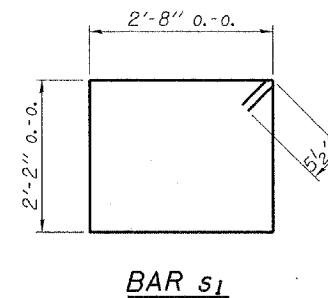

BAR s1

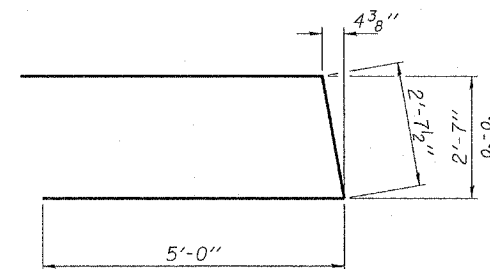

BAR u2

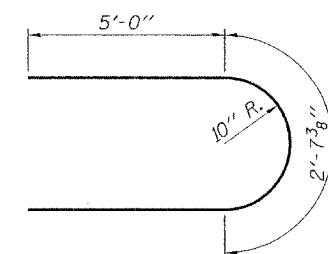

BAR u1

BILL OF MATERIAL - PIER 2

BAR	NO.	SIZE	LENGTH	SHAPE
h ₃	32	#5	22'-0"	—
n	26	#5	4'-8"	□
p	11	#7	25'-7"	—
s ₁	26	#5	10'-7"	□
u ₁	32	#5	12'-8"	U
u ₂	8	#6	12'-8"	U
v ₄	48	#5	15'-10"	—
Concrete Structures			Cu. Yd.	35.0
Reinforcement Bars			Pound	3,120
Steel Piles HP10x42			Foot	135
Setting Piles in Rock			Each	5

PILE DATA

Type..... Steel HP10x42
 No. Req'd..... 5
 Allowable Resistance Available..... 100 Kips/Pile
 Est. Length..... 27 Feet/Pile

Notes: The Steel H-Piles shall be according to ASHTO M270 Grade 50.
 See Sheet 14 for pile details.

HAMPTON, LENZINI & RENWICK, INC.
 CIVIL & STRUCTURAL ENGINEERS
 LAND SURVEYORS

3085 STEVENSON DRIVE, SUITE 201
 SPRINGFIELD, ILLINOIS 62703
 (217) 546-3400

ELGIN • SPRINGFIELD

PROJECT NUMBER: 12-87-0018-1 DATE: 01/23/08
 DESIGNED: R.J.P. CHECKED: S.W.M. DRAWN: D.T.M.

PIER 2
SECTION 06-03113-00-BR
CLARKSBURG ROAD DISTRICT
SHELBY COUNTY
STRUCTURE NO. 087-3561 / STATION 10+00

CLASS DS CONCRETE TO BE INCLUDED IN THE COST OF SETTING PILES IN ROCK (TYP.)