

PLAN VIEW

TOTAL BILL OF MATERIALS

ITEM	UNIT	TOTAL
CONCRETE SEALER	SQ FT	47,142

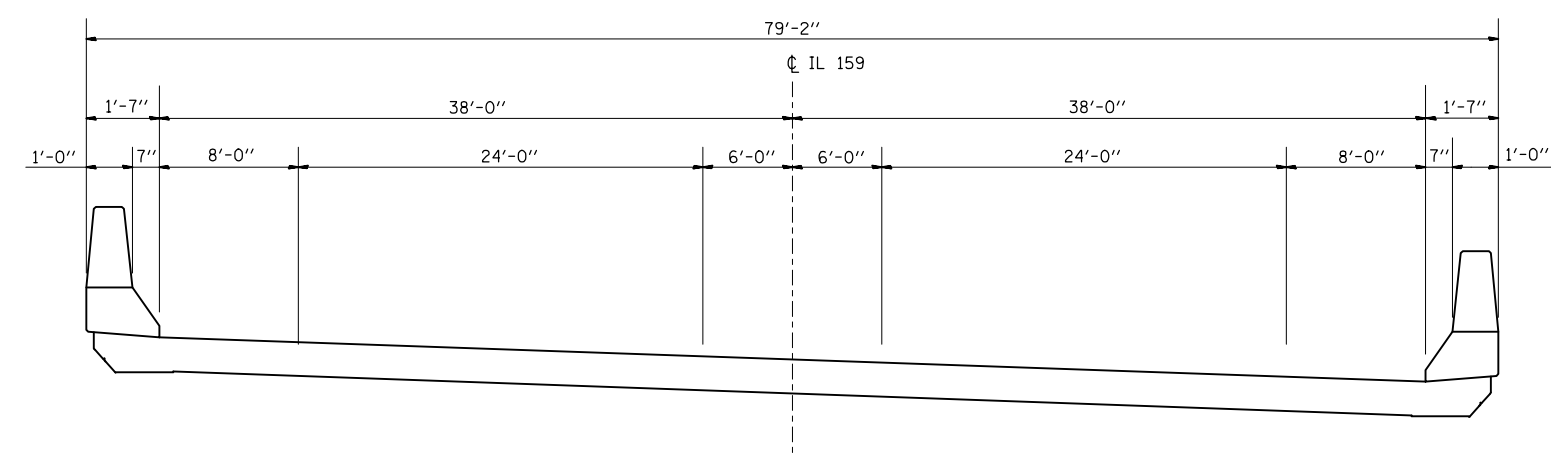

TYPICAL SECTION

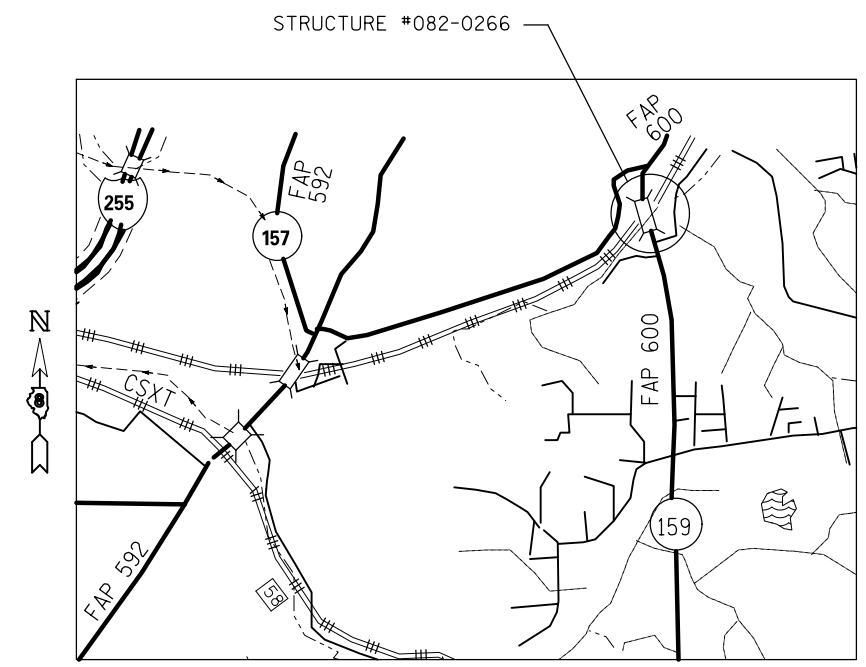

LOCATION MAP