

INDEX OF SHEETS

- 1. COVER SHEET
- 2. GENERAL NOTES
- 3 - 5. SUMMARY OF QUANTITIES
- 6. WORK ORDER
- 7. PAVEMENT MARKING SUMMARY
- 8 - 15. TYPICAL PAVEMENT MARKING

HIGHWAY STANDARDS

- 701001-02 OFF-ROAD OPERATIONS 2L, 2W, MORE THAN 15' AWAY
- 701006-05 OFF-ROAD OPERATIONS 2L, 2W, 15' TO 24" FROM PAVEMENT EDGE
- 701101-05 OFF-ROAD OPERATIONS, MULTILANE, 15' TO 24" FROM PAVEMENT EDGE
- 701106-02 OFF-ROAD OPERATIONS, MULTILANE, MORE THAN 15' AWAY
- 701201-05 LANE CLOSURE, 2L, 2W, DAY ONLY, FOR SPEEDS ≥ 45 MPH
- 701301-04 LANE CLOSURE, 2L, 2W, SHORT TIME OPERATIONS
- 701311-03 LANE CLOSURE, 2L, 2W, MOVING OPERATIONS - DAY ONLY
- 701400-11 APPROACH TO LANE CLOSURE, FREEWAY/EXPRESSWAY
- 701401-13 LANE CLOSURE, FREEWAY/EXPRESSWAY
- 701406-13 LANE CLOSURE, FREEWAY/EXPRESSWAY, DAY OPERATIONS ONLY
- 701411-09 LANE CLOSURE, MULTILANE, AT ENTRANCE OR EXIT RAMP FOR SPEEDS ≥ 45 MPH
- 701426-09 LANE CLOSURE, MULTILANE INTERMITTENT OR MOVING OPERATION, FOR SPEEDS ≥ 45 MPH
- 701427-05 LANE CLOSURE, MULTILANE INTERMITTENT OR MOVING OPERATION, FOR SPEEDS ≤ 40 MPH
- 701428-01 TRAFFIC CONTROL, SETUP AND REMOVAL, FREEWAY/EXPRESSWAY
- 701501-06 URBAN LANE CLOSURE, 2L, 2W, UNDIVIDED
- 701502-09 URBAN LANE CLOSURE 2L, 2W, WITH BIDIRECTIONAL LEFT TURN LANE
- 701601-09 URBAN LANE CLOSURE, MULTILANE, 1W OR 2W WITH NONTRAVERSABLE MEDIAN
- 701602-10 URBAN LANE CLOSURE, MULTILANE, 2W WITH BIDIRECTIONAL LEFT TURN LANE
- 701701-10 URBAN LANE CLOSURE, MULTILANE INTERSECTION
- 701901-08 TRAFFIC CONTROL DEVICES

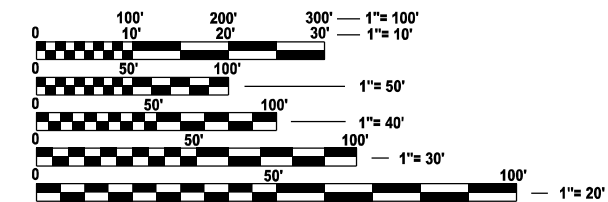

FULL SIZE PLANS HAVE BEEN PREPARED USING STANDARD ENGINEERING SCALES. REDUCED SIZED PLANS WILL NOT CONFORM TO STANDARD SCALES. IN MAKING MEASUREMENTS ON REDUCED PLANS, THE ABOVE SCALES MAY BE USED.

J.U.L.I.E.
JOINT UTILITY LOCATION INFORMATION FOR EXCAVATION
 1-800-892-0123
 OR 811

PROJECT ENGINEER: TOM SCHAEFER
PROJECT MANAGER: ANDREW CARMIN
DISTRICT NO. 3 (815)434-6131
CONTRACT NO. 46635

STATE OF ILLINOIS
DEPARTMENT OF TRANSPORTATION

PROPOSED
HIGHWAY PLANS

VARIOUS ROUTES
SECTION D 3 HT PVMNT MRK RPR 24-16
HIGH TYPE PAVEMENT MARKING
VARIOUS COUNTIES

M-60-016-24

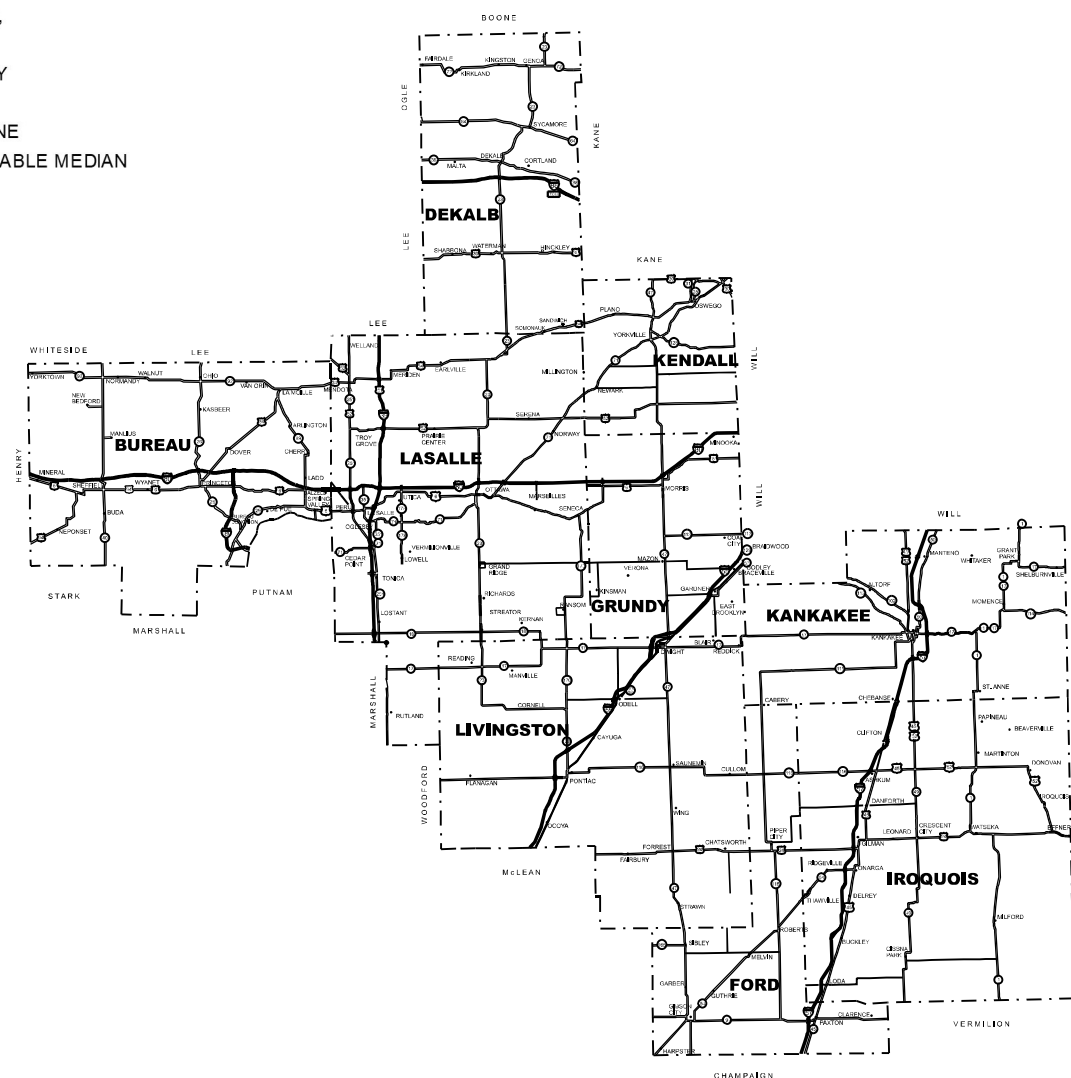

F.A. RTE.	SECTION	COUNTY	TOTAL SHEETS	SHEET NO.
VAR	D 3 HT PVMNT MRK RPR 24-16	VARIOUS	15	1
		ILLINOIS	CONTRACT NO. 46635	

D-93-008-24

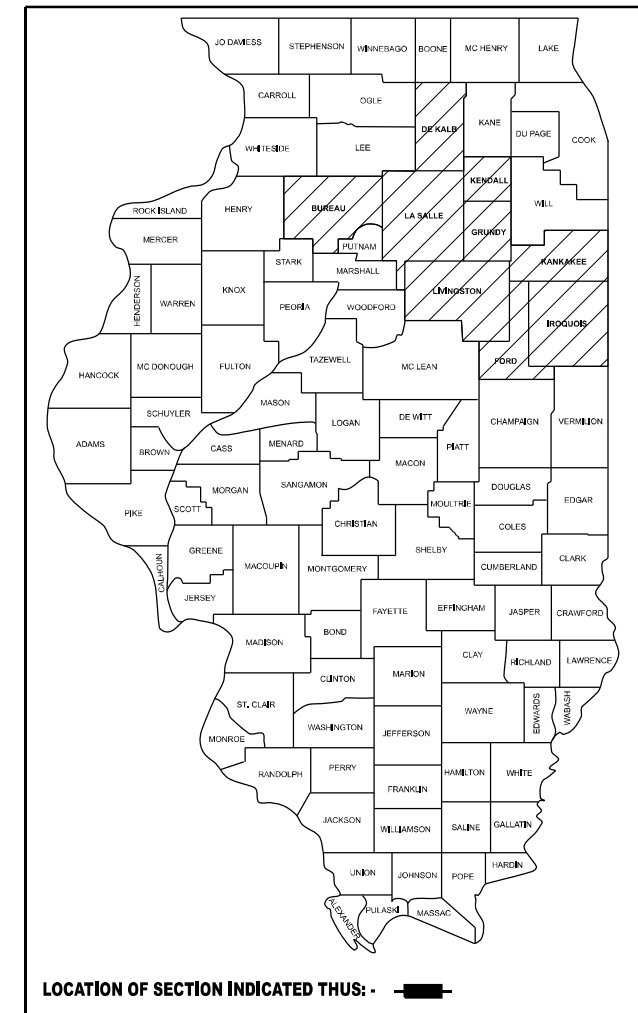

STATE OF ILLINOIS
DEPARTMENT OF TRANSPORTATION

SUBMITTED August 31, 2023

[Signature] REGIONAL ENGINEER

October 13, 2023

[Signature] ENGINEER OF DESIGN AND ENVIRONMENT

October 13, 2023

[Signature] DIRECTOR OF HIGHWAYS PROJECT IMPLEMENTATION

PRINTED BY THE AUTHORITY
OF THE STATE OF ILLINOIS

GENERAL NOTES

PREFORMED PLASTIC PAVEMENT MARKING, TYPE D - STANDARD- LINE 9" SHALL BE CONSIDERED AS "CONTRAST PAVEMENT MARKING (6" WHITE LINE WITH 1½" BLACK BORDER)". GROOVING FOR RECESSED PAVEMENT MARKINGS 10" SHALL BE USED WITH THIS WORK.

COMMITMENTS

NONE

**STATE OF ILLINOIS
DEPARTMENT OF TRANSPORTATION
DISTRICT THREE
AS BUILT INFORMATION**

SUPERVISING CONSTRUCTION FIELD ENGINEER

RESIDENT ENGINEER / TECHNICIAN

**START & END DATES
OF CONSTRUCTION:**

INSPECTORS:

MODEL: D:\infuit
FILE NAME: j:\work\pva\jerry.com\PM\DOT\Documents\DOT Office\District 3\ORD Projects\District 3\ORD Projects\District 3\CAD Data\CADD Sheets\46635 COVER.dgn

USER NAME = ronald.woodshank	DESIGNED - RW	REVISED - _____
	DRAWN - RW	REVISED - _____
PLOT SCALE = 100,000' / in.	CHECKED - YP	REVISED - _____
PLOT DATE = 8/24/2023	DATE - 7/28/2023	REVISED - _____

**STATE OF ILLINOIS
DEPARTMENT OF TRANSPORTATION**

GENERAL NOTES

SCALE: _____ SHEET 2 OF 1 SHEETS STA. _____ TO STA. _____

F.A. RTE.	SECTION	COUNTY	TOTAL SHEETS	SHEET NO.
VAR	D 3 HT PVMNT MRK RPR 24-16	VARIOUS	15	2
			CONTRACT NO. 46635	
		ILLINOIS	FED. AID PROJECT	

CODE NO.	ITEM	UNIT	TOTAL QUANTITY	CONSTRUCTION CODE
				100% STATE
				PAVEMENT MARKING 0021
78000100	THERMOPLASTIC PAVEMENT MARKING - LETTERS AND SYMBOLS	SQ FT	2000	2000
78000200	THERMOPLASTIC PAVEMENT MARKING - LINE 4"	FOOT	8000	8000
78000400	THERMOPLASTIC PAVEMENT MARKING - LINE 6"	FOOT	1000	1000
78000500	THERMOPLASTIC PAVEMENT MARKING - LINE 8"	FOOT	3000	3000
78000600	THERMOPLASTIC PAVEMENT MARKING - LINE 12"	FOOT	1000	1000
78000650	THERMOPLASTIC PAVEMENT MARKING - LINE 24"	FOOT	1000	1000
78001110	PAINT PAVEMENT MARKING - LINE 4"	FOOT	75000	75000
78001130	PAINT PAVEMENT MARKING - LINE 6"	FOOT	40000	40000
78004630	PREFORMED PLASTIC PAVEMENT MARKING, TYPE D - STANDARD - LINE 6"	FOOT	45000	45000
78004645	PREFORMED PLASTIC PAVEMENT MARKING, TYPE D - STANDARD - LINE 9"	FOOT	7500	7500
78004720	PREFORMED PLASTIC PAVEMENT MARKING, TYPE D - STANDARD - LINE 24"	FOOT	1000	1000
78005110	EPOXY PAVEMENT MARKING - LINE 4"	FOOT	750000	750000
78005130	EPOXY PAVEMENT MARKING - LINE 6"	FOOT	1000	1000
78005140	EPOXY PAVEMENT MARKING - LINE 8"	FOOT	4000	4000

MODEL: Default
 FILE NAME: \\p02010001\jerry.com\PM\DOT\Documents\DOT Office\District 3\ORD Projects\District 3\ORD Projects\46635\CAD\Sheets\46635 COVER.dgn

USER NAME = ronald.woodshank	DESIGNED - RW	REVISED - _____
	DRAWN - RW	REVISED - _____
PLOT SCALE = 100,000 / 1in.	CHECKED - YP	REVISED - _____
PLOT DATE = 8/24/2023	DATE - 7/28/2023	REVISED - _____

STATE OF ILLINOIS
DEPARTMENT OF TRANSPORTATION

SUMMARY OF QUANTITIES	
SCALE: _____	SHEET 1 OF 3 SHEETS STA. _____ TO STA. _____

F.A. RTE.	SECTION	COUNTY	TOTAL SHEETS	SHEET NO.
VAR	D 3 HT PVMNT MRK RPR 24-16	VARIOUS	15	3
			CONTRACT NO. 46635	
		ILLINOIS	FED. AID PROJECT	

MODEL: Default
 FILE NAME: \\p01bls01p01\jerry.com\PM\DOT\Documents\DOT Office\District 3\ORD Projects\0346635\CAD\Drawings\CADD Sheets\46635 COVER.dgn

CODE NO.	ITEM	UNIT	TOTAL QUANTITY	CONSTRUCTION CODE	
				100% STATE	
				PAVEMENT MARKING	
				0021	
78008210	POLYUREA PAVEMENT MARKING TYPE I - LINE 4"	FOOT	175000	175000	
78008230	POLYUREA PAVEMENT MARKING TYPE I - LINE 6"	FOOT	50000	50000	
78008240	POLYUREA PAVEMENT MARKING TYPE I - LINE 8"	FOOT	25000	25000	
78009000	MODIFIED URETHANE PAVEMENT MARKING - LETTERS AND SYMBOLS	SQ FT	8000	8000	
78009004	MODIFIED URETHANE PAVEMENT MARKING - LINE 4"	FOOT	500000	500000	
78009006	MODIFIED URETHANE PAVEMENT MARKING - LINE 6"	FOOT	95000	95000	
78009008	MODIFIED URETHANE PAVEMENT MARKING - LINE 8"	FOOT	60000	60000	
78009012	MODIFIED URETHANE PAVEMENT MARKING - LINE 12"	FOOT	8000	8000	
78009024	MODIFIED URETHANE PAVEMENT MARKING - LINE 24"	FOOT	3000	3000	
78011000	GROOVING FOR RECESSED PAVEMENT MARKING, LETTERS AND SYMBOLS	SQ FT	4000	4000	
78011025	GROOVING FOR RECESSED PAVEMENT MARKING 5"	FOOT	200000	200000	
78011035	GROOVING FOR RECESSED PAVEMENT MARKING 7"	FOOT	55000	55000	
78011045	GROOVING FOR RECESSED PAVEMENT MARKING 9"	FOOT	5000	5000	
78011050	GROOVING FOR RECESSED PAVEMENT MARKING 10"	FOOT	7500	7500	

USER NAME = ronald.woodshank	DESIGNED - RW	REVISED - _____
	DRAWN - RW	REVISED - _____
PLOT SCALE = 100,000 / 1in.	CHECKED - YP	REVISED - _____
PLOT DATE = 8/24/2023	DATE - 7/28/2023	REVISED - _____

**STATE OF ILLINOIS
DEPARTMENT OF TRANSPORTATION**

SUMMARY OF QUANTITIES

SCALE: _____ SHEET 2 OF 3 SHEETS STA. _____ TO STA. _____

F.A. RTE.	SECTION	COUNTY	TOTAL SHEETS	SHEET NO.
VAR	D 3 HT PVMNT MRK RPR 24+16	VARIOUS	15	4
			CONTRACT NO. 46635	
		ILLINOIS	FED. AID PROJECT	

MODEL: D:\infuit...
 FILE NAME: D:\infuit...
 PROJECT: ...

CODE NO.	ITEM	UNIT	TOTAL QUANTITY	CONSTRUCTION CODE
				100% STATE
				PAVEMENT MARKING
				0021
78011065	GROOVING FOR RECESSED PAVEMENT MARKING 13"	FOOT	500	500
78011125	GROOVING FOR RECESSED PAVEMENT MARKING 25"	FOOT	1000	1000
78300201	PAVEMENT MARKING REMOVAL - GRINDING	SQ FT	40000	40000
78300202	PAVEMENT MARKING REMOVAL - WATER BLASTING	SQ FT	1000	1000
X7800815	HOT SPRAY THERMOPLASTIC PAVEMENT MARKING LINE - 4 INCH	FOOT	75000	75000
X7800835	HOT SPRAY THERMOPLASTIC PAVEMENT MARKING LINE - 6 INCH	FOOT	30000	30000
X7800845	HOT SPRAY THERMOPLASTIC PAVEMENT MARKING LINE - 8 INCH	FOOT	5000	5000
Z0008758	AERIAL SPEED CHECK MARKING	FOOT	200	200

USER NAME = ronald.woodshank	DESIGNED - RW	REVISED - _____
DRAWN - RW	CHECKED - YP	REVISED - _____
PLOT SCALE = 100,000' / 1in.	DATE - 7/28/2023	REVISED - _____
PLOT DATE = 8/24/2023		

**STATE OF ILLINOIS
 DEPARTMENT OF TRANSPORTATION**

SUMMARY OF QUANTITIES

SCALE: _____ SHEET 3 OF 3 SHEETS STA. _____ TO STA. _____

F.A. RTE.	SECTION	COUNTY	TOTAL SHEETS	SHEET NO.
VAR	D 3 HT PVMNT MRK RPR 24+16	VARIOUS	15	5
			CONTRACT NO. 46635	
		ILLINOIS	FED. AID PROJECT	

**WORK ORDER
D3 HT PVMNT MRKG RPR 24-16**

WORK ORDER NO. _____ DATE ISSUED _____ ROUTE _____

LOCATION DESCRIPTION _____

CONTRACT NO.: 46635

JOB NO.: M-60-016-24

CODE NUMBER	ITEM	UNIT	QUANTITY	UNIT PRICE	ITEM COST
78000100	THERMOPLASTIC PAVEMENT MARKING - LETTERS AND SYMBOLS	SQ FT	2,000.00		
78000200	THERMOPLASTIC PAVEMENT MARKING - LINE 4"	FOOT	8,000.00		
78000400	THERMOPLASTIC PAVEMENT MARKING - LINE 6"	FOOT	1,000.00		
78000500	THERMOPLASTIC PAVEMENT MARKING - LINE 8"	FOOT	3,000.00		
78000600	THERMOPLASTIC PAVEMENT MARKING - LINE 12"	FOOT	1,000.00		
78000650	THERMOPLASTIC PAVEMENT MARKING - LINE 24"	FOOT	1,000.00		
78001110	PAINT PAVEMENT MARKING - LINE 4"	FOOT	75,000.00		
78001130	PAINT PAVEMENT MARKING - LINE 6"	FOOT	40,000.00		
78004630	PREFORMED PLASTIC PAVEMENT MARKING, TYPE D - STANDARD - LINE 6"	FOOT	45,000.00		
78004645	PREFORMED PLASTIC PAVEMENT MARKING, TYPE D - STANDARD - LINE 9"	FOOT	7,500.00		
78004720	PREFORMED PLASTIC PAVEMENT MARKING, TYPE D - STANDARD - LINE 24"	FOOT	1,000.00		
78005110	EPOXY PAVEMENT MARKING - LINE 4"	FOOT	750,000.00		
78005130	EPOXY PAVEMENT MARKING - LINE 6"	FOOT	1,000.00		
78005140	EPOXY PAVEMENT MARKING - LINE 8"	FOOT	4,000.00		
78008210	POLYUREA PAVEMENT MARKING TYPE I - LINE 4"	FOOT	175,000.00		
78008230	POLYUREA PAVEMENT MARKING TYPE I - LINE 6"	FOOT	50,000.00		
78008240	POLYUREA PAVEMENT MARKING TYPE I - LINE 8"	FOOT	25,000.00		
78009000	MODIFIED URETHANE PAVEMENT MARKING - LETTERS AND SYMBOLS	SQ FT	8,000.00		
78009004	MODIFIED URETHANE PAVEMENT MARKING - LINE 4"	FOOT	500,000.00		
78009006	MODIFIED URETHANE PAVEMENT MARKING - LINE 6"	FOOT	95,000.00		
78009008	MODIFIED URETHANE PAVEMENT MARKING - LINE 8"	FOOT	60,000.00		
78009012	MODIFIED URETHANE PAVEMENT MARKING - LINE 12"	FOOT	8,000.00		
78009024	MODIFIED URETHANE PAVEMENT MARKING - LINE 24"	FOOT	3,000.00		
78011000	GROOVING FOR RECESSED PAVEMENT MARKING, LETTERS AND SYMBOLS	SQ FT	4,000.00		
78011025	GROOVING FOR RECESSED PAVEMENT MARKING 5"	FOOT	200,000.00		
78011035	GROOVING FOR RECESSED PAVEMENT MARKING 7"	FOOT	55,000.00		
78011045	GROOVING FOR RECESSED PAVEMENT MARKING 9"	FOOT	5,000.00		
78011050	GROOVING FOR RECESSED PAVEMENT MARKING 10"	FOOT	7,500.00		
78011065	GROOVING FOR RECESSED PAVEMENT MARKING 13"	FOOT	500.00		
78011125	GROOVING FOR RECESSED PAVEMENT MARKING 25"	FOOT	1,000.00		
78300201	PAVEMENT MARKING REMOVAL - GRINDING	SQ FT	40,000.00		
78300202	PAVEMENT MARKING REMOVAL - WATER BLASTING	SQ FT	1,000.00		
X7800815	HOT SPRAY THERMOPLASTIC PAVEMENT MARKING LINE - 4 INCH	FOOT	75,000.00		
X7800835	HOT SPRAY THERMOPLASTIC PAVEMENT MARKING LINE - 6 INCH	FOOT	30,000.00		
X7800845	HOT SPRAY THERMOPLASTIC PAVEMENT MARKING LINE - 8 INCH	FOOT	5,000.00		
Z0008758	AERIAL SPEED CHECK MARKING	FOOT	200.00		

DISTRICT CONTACT

NAME: OPS TRAFFIC ENG
TELEPHONE: 815/434-8446
CELL PHONE: _____

SUBMITTED BY: _____ REGIONAL ENGINEER

DATE: _____

MODEL: D:\in\it\p\work\pvmnt\mrcg\mrcg.dwg
FILE NAME: D:\in\it\p\work\pvmnt\mrcg\mrcg.dwg
PROJECT: D:\in\it\p\work\pvmnt\mrcg\mrcg.dwg
SHEET: 15 OF 15
DATE: 8/24/2023

USER NAME = ronald.woodshank	DESIGNED - RW	REVISED - _____
	DRAWN - RW	REVISED - _____
PLOT SCALE = 100,000' / 1in.	CHECKED - YP	REVISED - _____
PLOT DATE = 8/24/2023	DATE - 7/28/2023	REVISED - _____

**STATE OF ILLINOIS
DEPARTMENT OF TRANSPORTATION**

WORK ORDER

SCALE: _____ SHEET 1 OF 1 SHEETS STA. _____ TO STA. _____

F.A. RTE.	SECTION	COUNTY	TOTAL SHEETS	SHEET NO.
VAR	D 3 HT PVMNT MRK RPR 24-16	VARIOUS	15	6
			CONTRACT NO. 46635	
ILLINOIS FED. AID PROJECT				

PAVEMENT MARKING SUMMARY

LOCATION ROUTE (LOCAL DESCRIPTION) COUNTY	SUMMATION OF QUANTITIES:								WORK ORDER NO.		
	CONTRACT NO. 46635 (M-60-016-24)										
	LETTERS & SYMBOLS	4"	4"	6"	8"	12"	12"	24"			
	SQ FT	FOOT	FOOT	FOOT	FOOT	FOOT	FOOT	FOOT	SQ FT	FOOT	Foot
	(WHITE)	(YELLOW)				(WHITE)	(YELLOW)				

MODEL: D:\inf\... FILE NAME: ... PROJECT: ... SHEETS: 46635 COVER.dgn

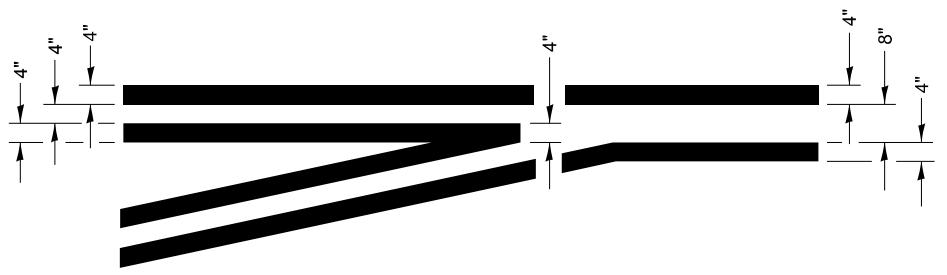

**LEFT TURN LANE
TYPICAL APPLICATION**

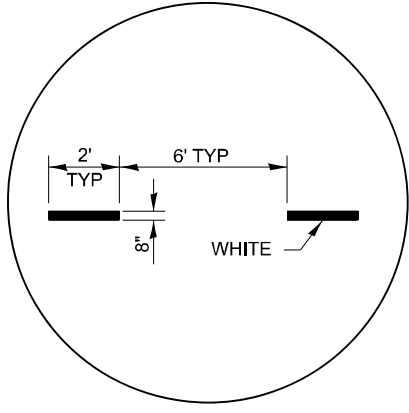

**ADVANCE AND INTERSECTION LANE
DIVIDER, INTERSTATE RAMP
TRANSITION LINES**

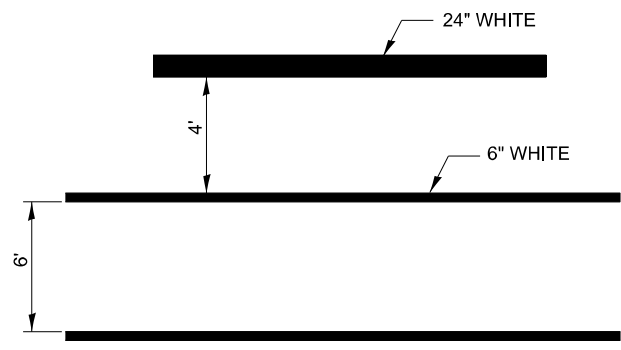

**TYPICAL SPACING DETAIL FOR
CROSSWALKS AND STOP BARS**

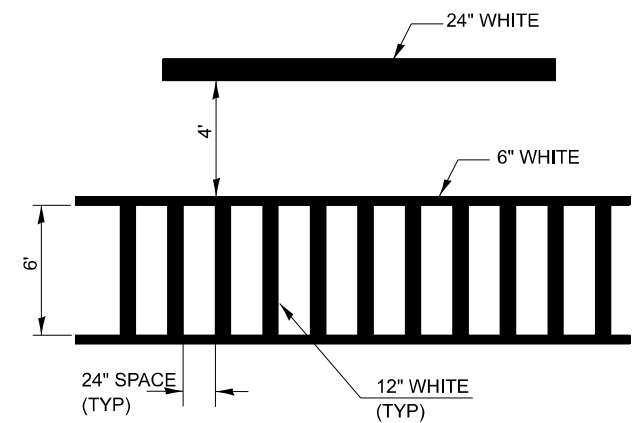

**TYPICAL SPACING DETAIL FOR
CROSSWALKS AND STOP BARS**

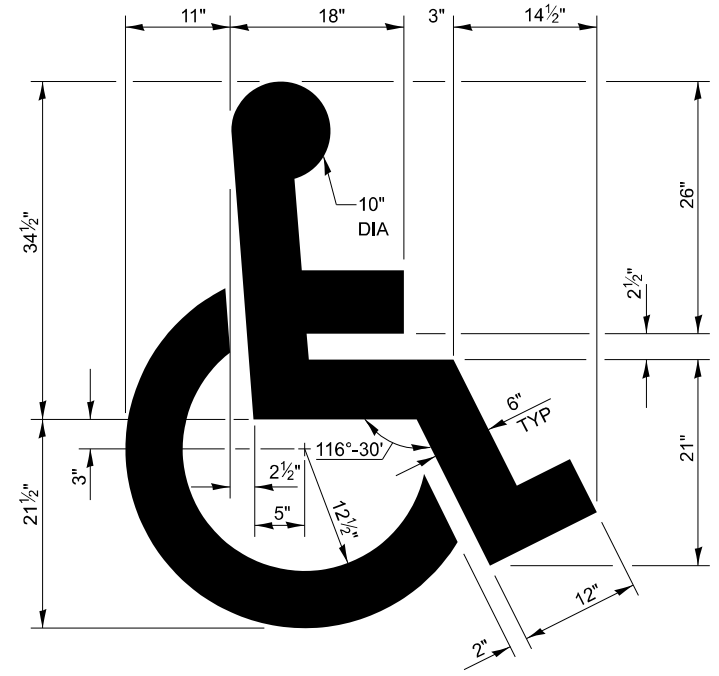

**TYPICAL DETAIL FOR
PAINTING HANDICAP MARKINGS**

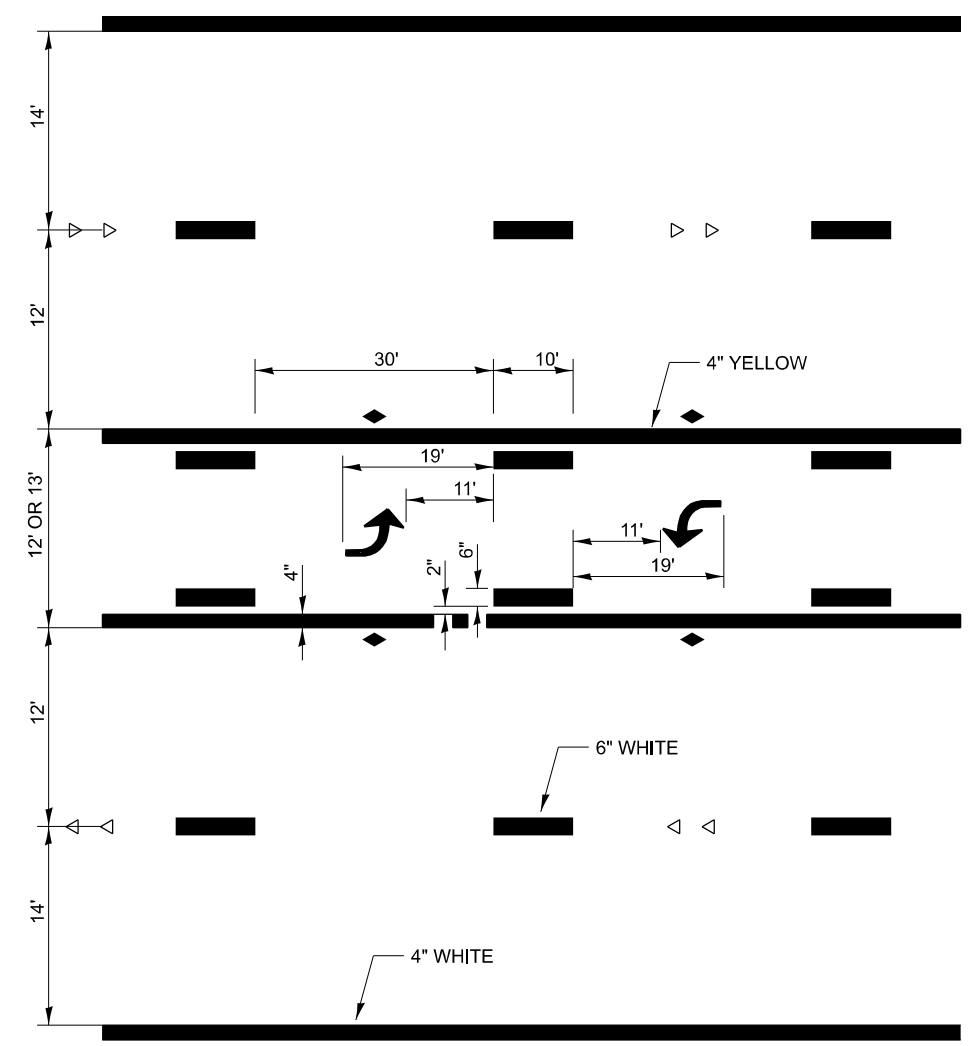

**TYPICAL APPLICATION @
TWO WAY LEFT TURN LANE (TWLTL)**

MODEL: D:\in\it... FILE NAME: ...

USER NAME = ronald.woodshank	DESIGNED - RW	REVISED -
DRAWN - RW	REVISOR -	
PLOT SCALE = 100,000 / 1in.	CHECKED - YP	REVISED -
PLOT DATE = 8/24/2023	DATE - 7/28/2023	REVISED -

**STATE OF ILLINOIS
DEPARTMENT OF TRANSPORTATION**

TYPICAL PAVEMENT MARKING	
SCALE: _____	SHEET 1 OF 8 SHEETS STA. _____ TO STA. _____

F.A. RTE.	SECTION	COUNTY	TOTAL SHEETS	SHEET NO.
VAR	D 3 HT PVMNT MRK RPR 24-16	VARIOUS	15	8
CONTRACT NO. 46635			ILLINOIS FED. AID PROJECT	

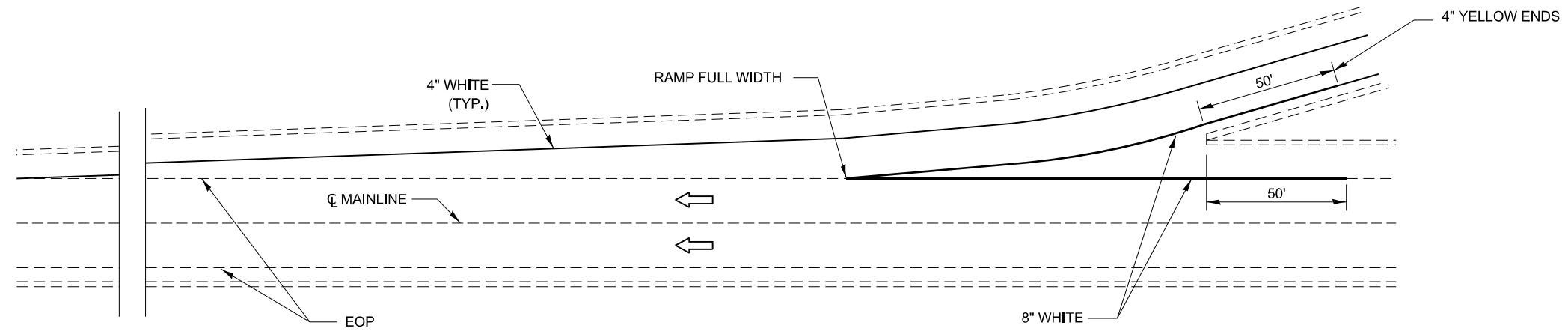

TYPICAL PAVEMENT MARKING FOR ENTRANCE RAMP TERMINALS

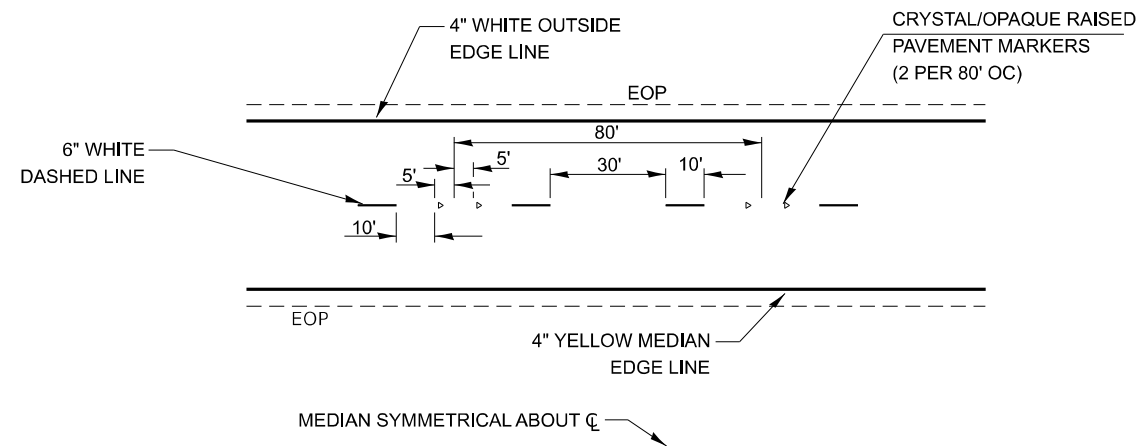

TYPICAL PAVEMENT MARKINGS

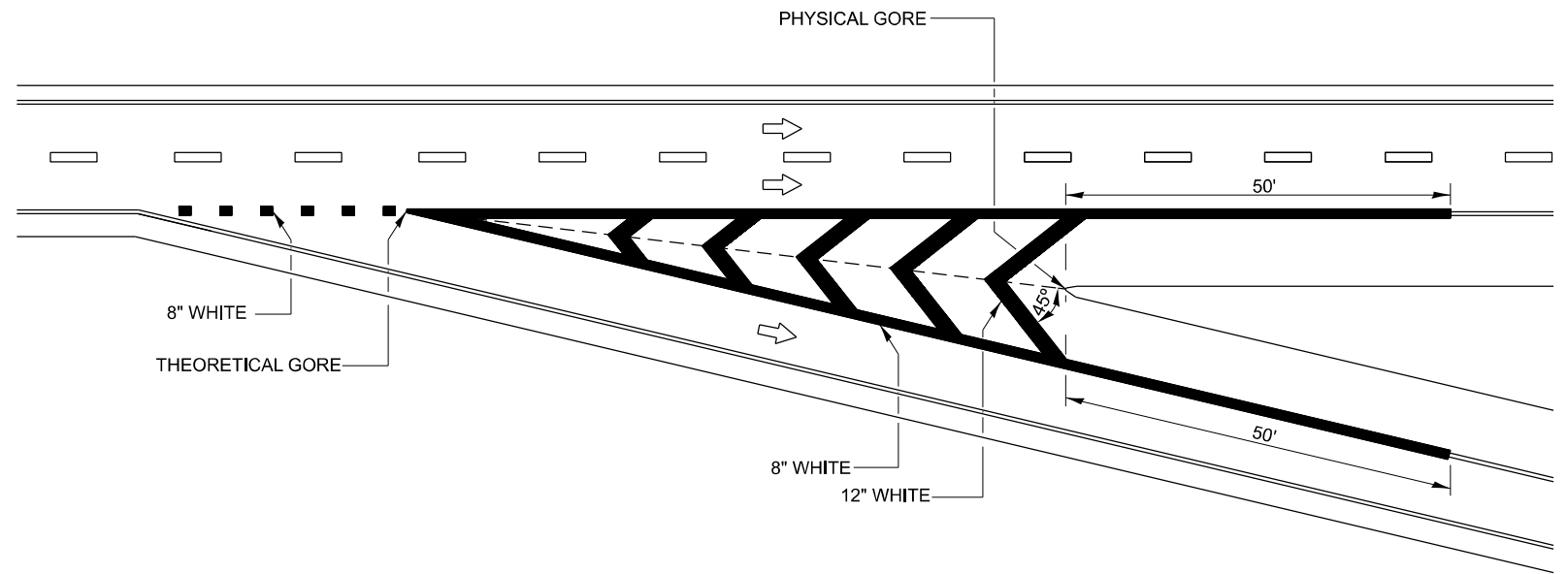

TYPICAL PAVEMENT MARKING FOR EXIT RAMP TERMINALS

MODEL: D:\in\it\...
 FILE NAME: ...

USER NAME = ronald.woodshank	DESIGNED - RW	REVISED -
	DRAWN - RW	REVISED -
PLOT SCALE = 100,000 / 1 in.	CHECKED - YP	REVISED -
PLOT DATE = 8/24/2023	DATE - 7/28/2023	REVISED -

**STATE OF ILLINOIS
DEPARTMENT OF TRANSPORTATION**

TYPICAL PAVEMENT MARKING

SCALE: _____ SHEET 2 OF 8 SHEETS STA. _____ TO STA. _____

F.A. RTE.	SECTION	COUNTY	TOTAL SHEETS	SHEET NO.
VAR	D 3 HT PVMNT MRK RPR 24-16	VARIOUS	15	9
CONTRACT NO. 46635				
ILLINOIS FED. AID PROJECT				

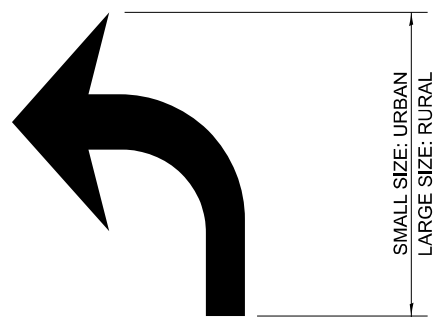

20' (6 M): URBAN
50' (15 M): RURAL
(BETWEEN ARROW
AND WORD OR
BETWEEN WORDS)

ONLY

6' (1.8 M): URBAN
8' (2.4 M): RURAL

WORD AND ARROW LAYOUT

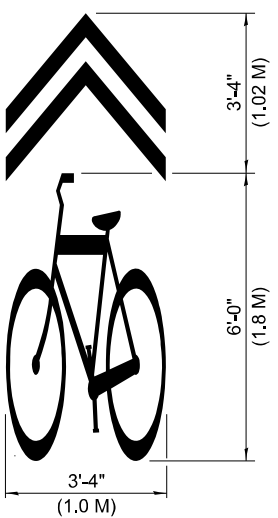

SHARED LANE SYMBOL

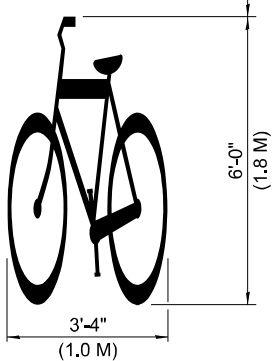
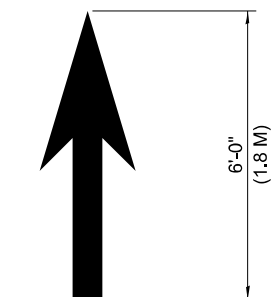

BIKE SYMBOL
(ARROW IS OPTIONAL.)

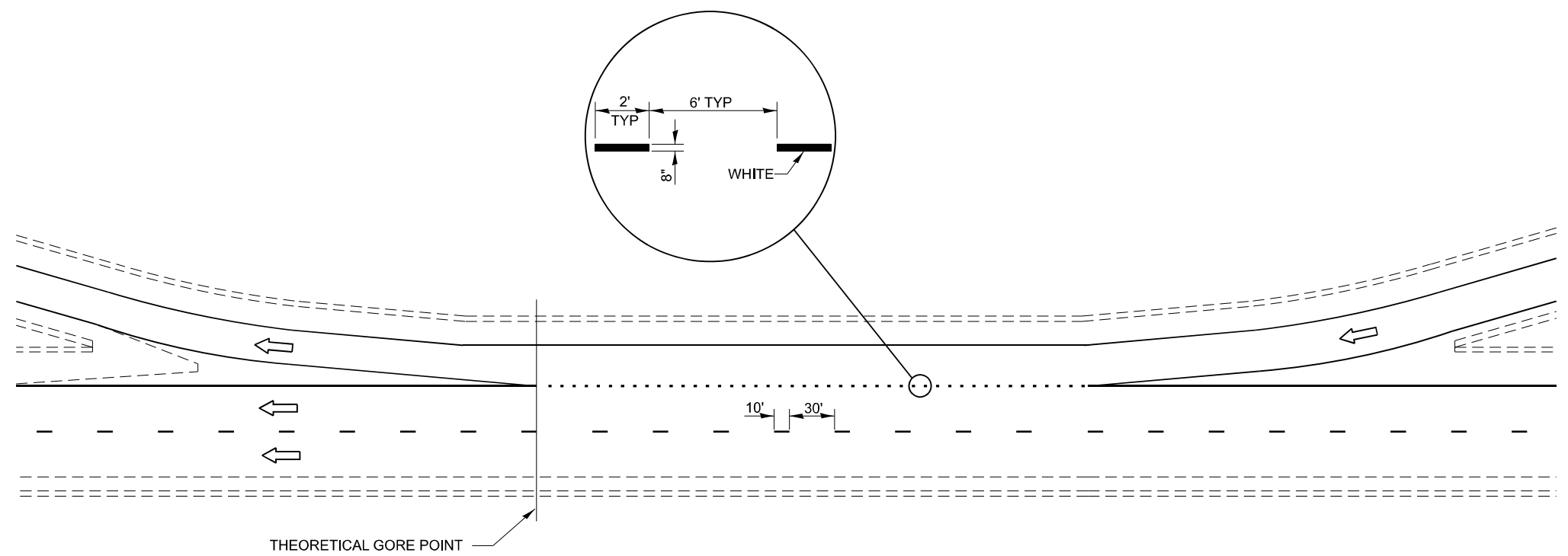

TYPICAL CLOVERLEAF LOOP RAMP MARKINGS

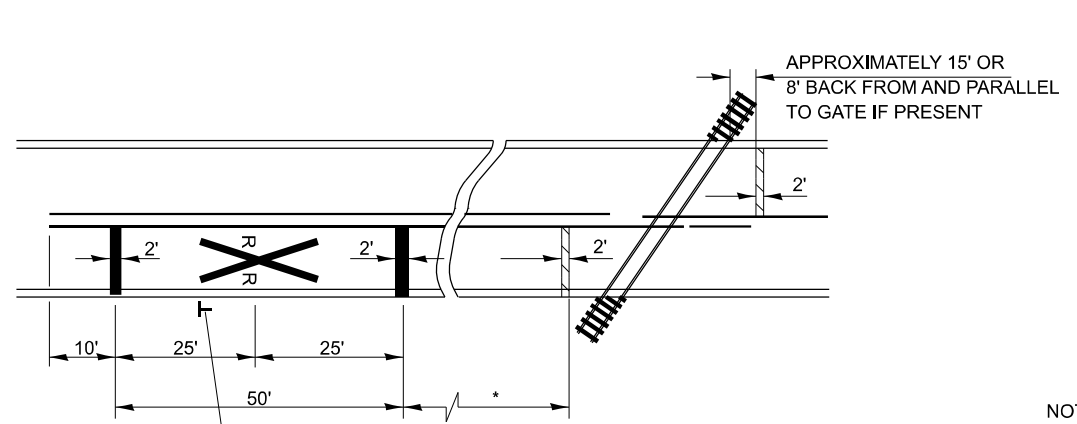

* MINIMUM DISTANCE
500' FOR 55 MPH
375' FOR 45 MPH
250' FOR 35 MPH OR LESS

PAVEMENT MARKINGS AT RAILROAD-HIGHWAY GRADE CROSSING

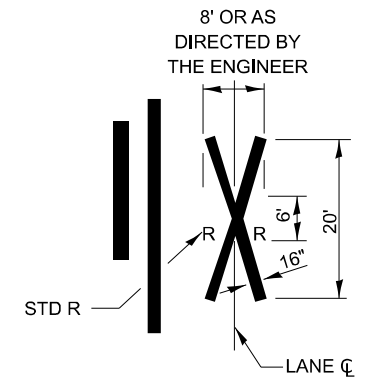

NOTES:
THE TRANSVERSE SPREAD OF THE "X" MAY VARY ACCORDING TO LANE WIDTH.
ON MULTI-LANE ROADS, THE STOP LINES SHALL EXTEND ACROSS ALL APPROACH LANES AND SEPARATE RXR SYMBOLS SHALL BE PLACED ADJACENT TO EACH OTHER IN EACH LANE.
WHEN THE PAVEMENT MARKING SYMBOL IS USED, A PORTION OF THE SYMBOL SHOULD BE LOCATED DIRECTLY ADJACENT TO THE ADVANCE WARNING SIGN (W10-1).

MODEL: D:\in\it... FILE NAME: ...

USER NAME = ronald.woodshank	DESIGNED - RW	REVISED -
DRAWN - RW	REVISED -	
PLOT SCALE = 100,000 / 1in.	CHECKED - YP	REVISED -
PLOT DATE = 8/24/2023	DATE - 7/28/2023	REVISED -

STATE OF ILLINOIS
DEPARTMENT OF TRANSPORTATION

TYPICAL PAVEMENT MARKING	
SCALE: _____	SHEET 3 OF 8 SHEETS STA. _____ TO STA. _____

F.A. RTE.	SECTION	COUNTY	TOTAL SHEETS	SHEET NO.
VAR	D 3 HT PVMNT MRK RPR 24-16	VARIOUS	15	10
			CONTRACT NO. 46635	
		ILLINOIS FED. AID PROJECT		

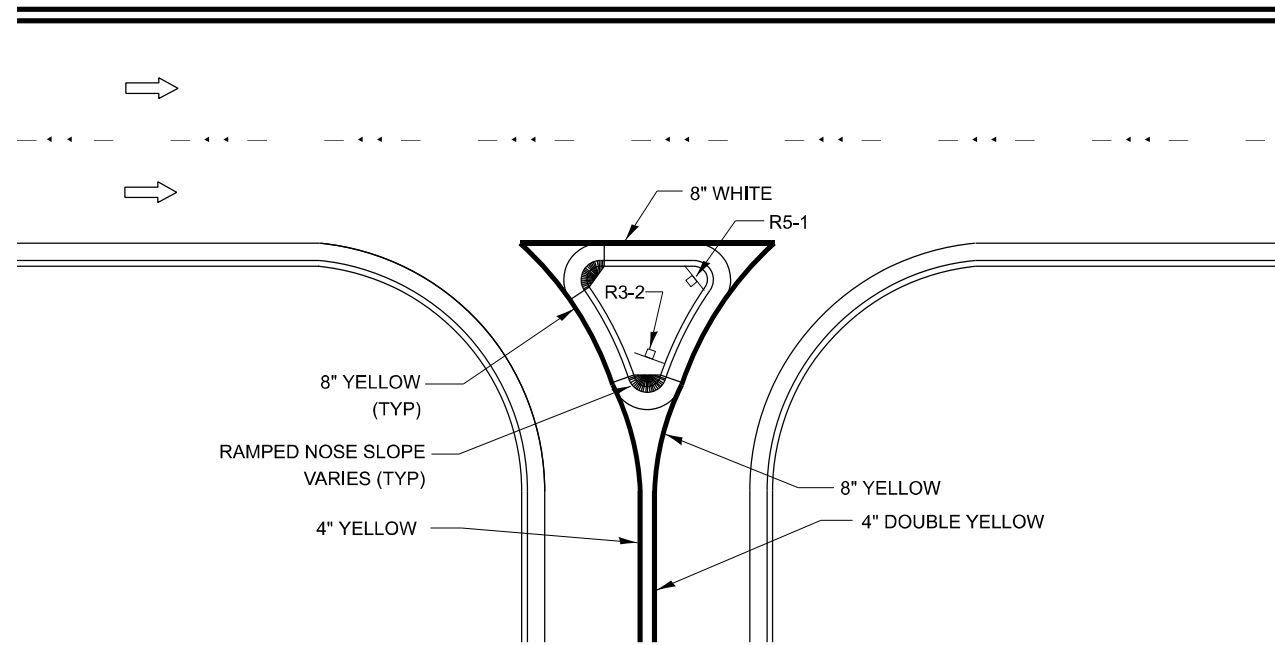

RIGHT IN RIGHT OUT ACCESS PAVEMENT MARKING

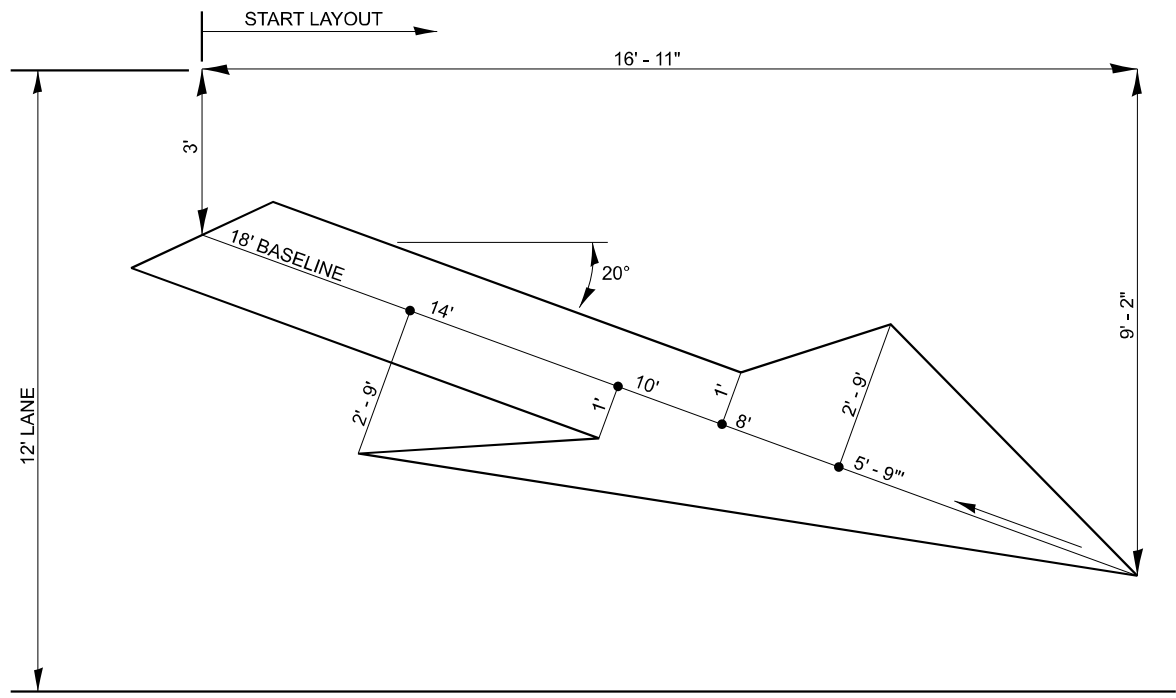

LARGE MERGE ARROWS
41.5 Sq. Ft.

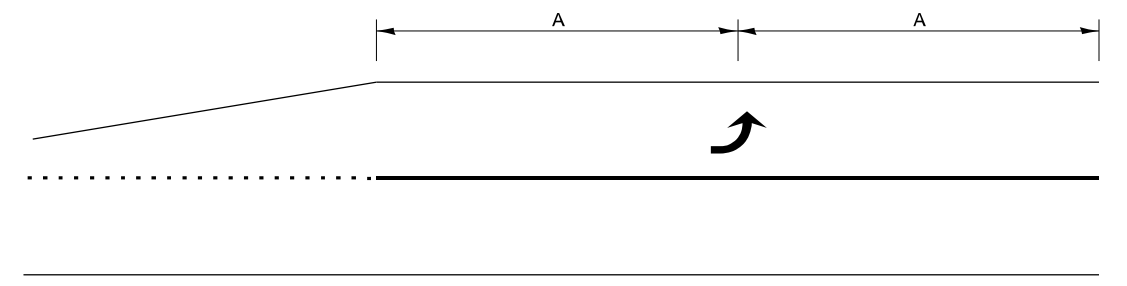

99' AND UNDER

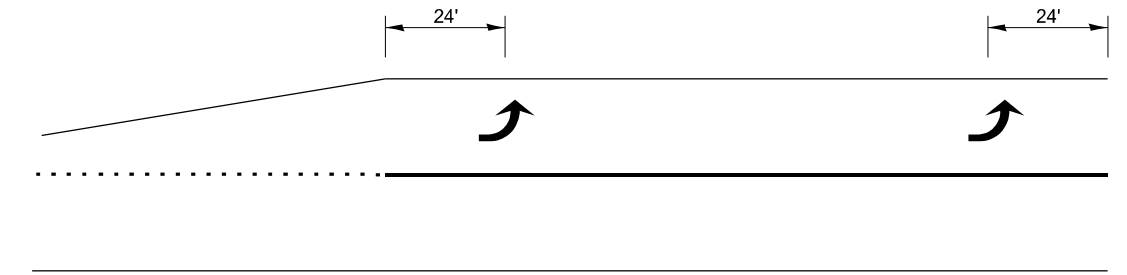

100' TO 149'

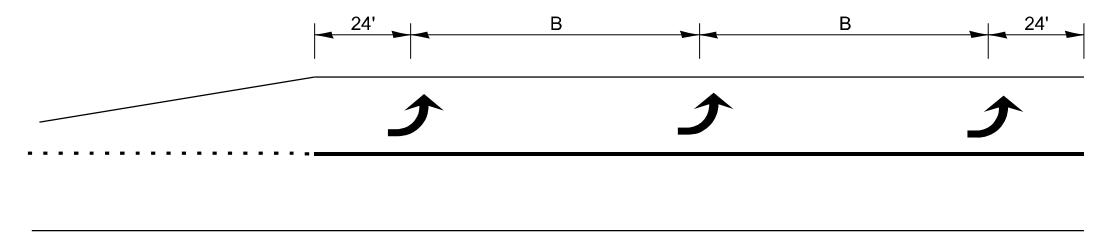

150' AND LONGER

TYPICAL PLACEMENT OF ARROWS
IN TURN LANES

MODEL: D:\in\it... FILE NAME: ...

USER NAME = ronald.woodshank	DESIGNED - RW	REVISED -
DRAWN - RW	CHECKED - YP	REVISED -
PLOT SCALE = 100,000' / 1" =	DATE - 7/28/2023	REVISED -
PLOT DATE = 8/24/2023		

STATE OF ILLINOIS
DEPARTMENT OF TRANSPORTATION

TYPICAL PAVEMENT MARKING

SCALE: SHEET 4 OF 8 SHEETS STA. TO STA.

F.A. RTE.	SECTION	COUNTY	TOTAL SHEETS	SHEET NO.
VAR	D 3 HT PVMNT MRK RPR 24-16	VARIOUS	15	11
ILLINOIS FED. AID PROJECT			CONTRACT NO. 46635	

MODEL: D:\rail\...
 FILE NAME: ...
 PROJECT: ...
 SHEETS: 46635 COVER.dgn

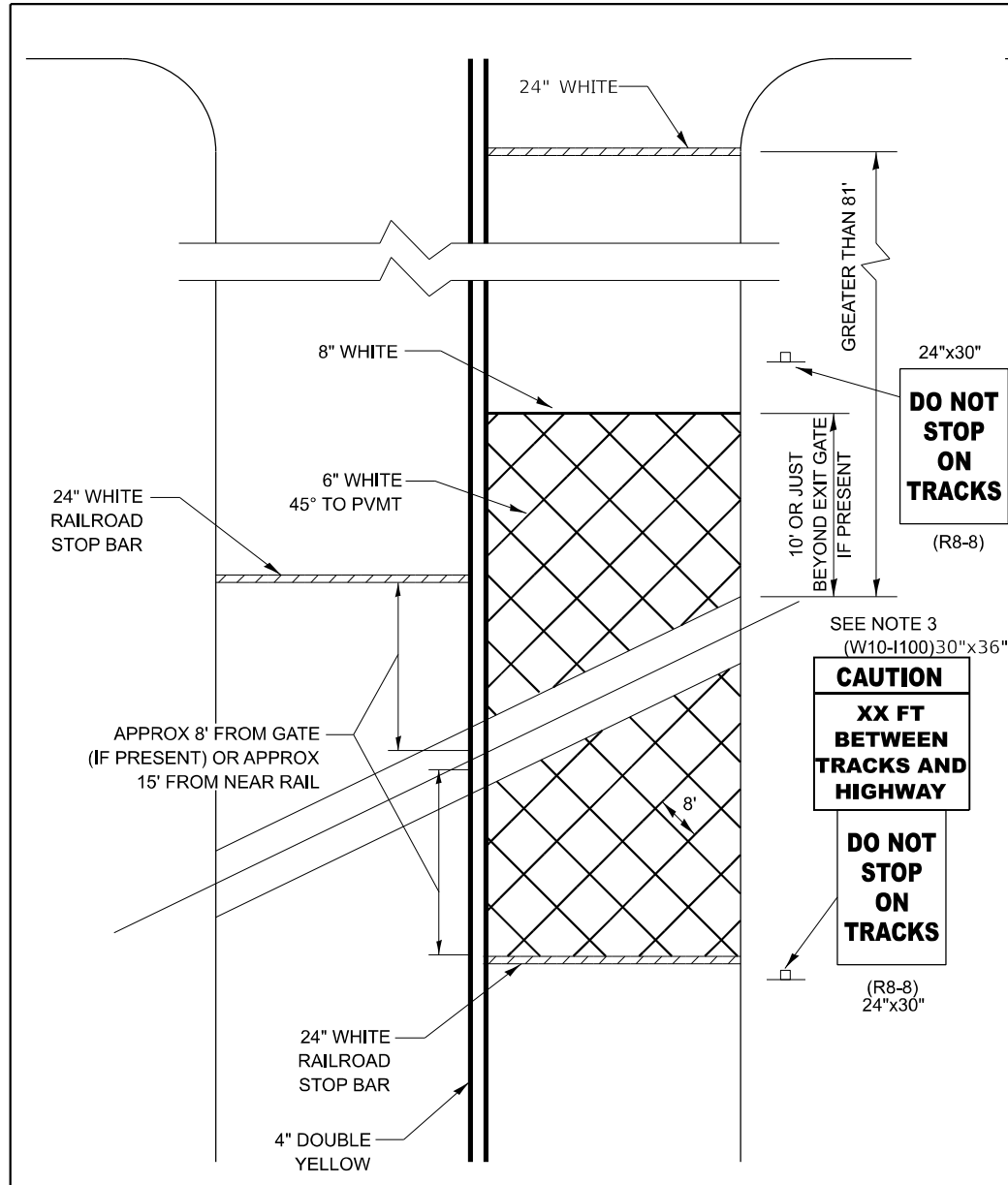

WITH INTERSECTION TRAFFIC SIGNALS

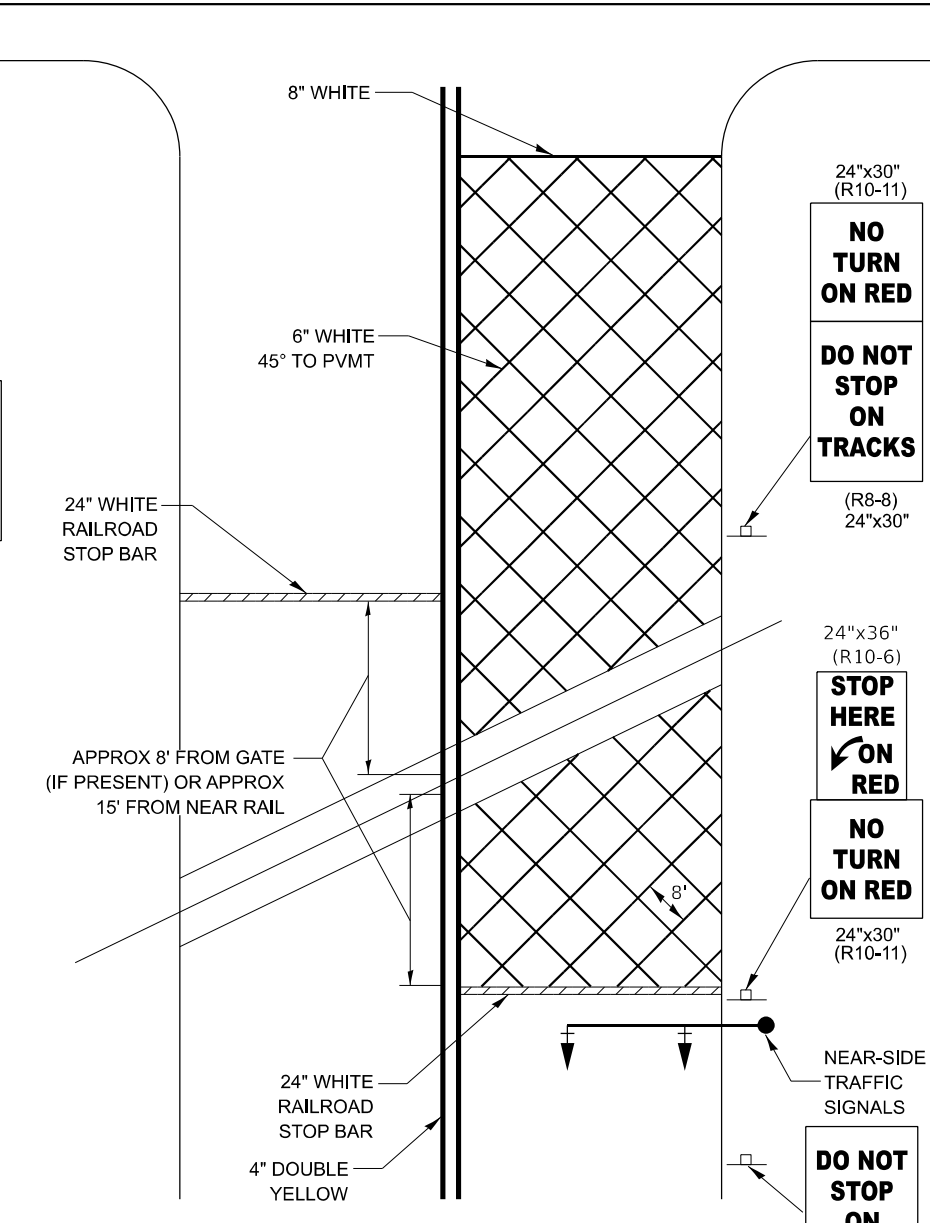

WITH NEAR-SIDE TRAFFIC SIGNALS

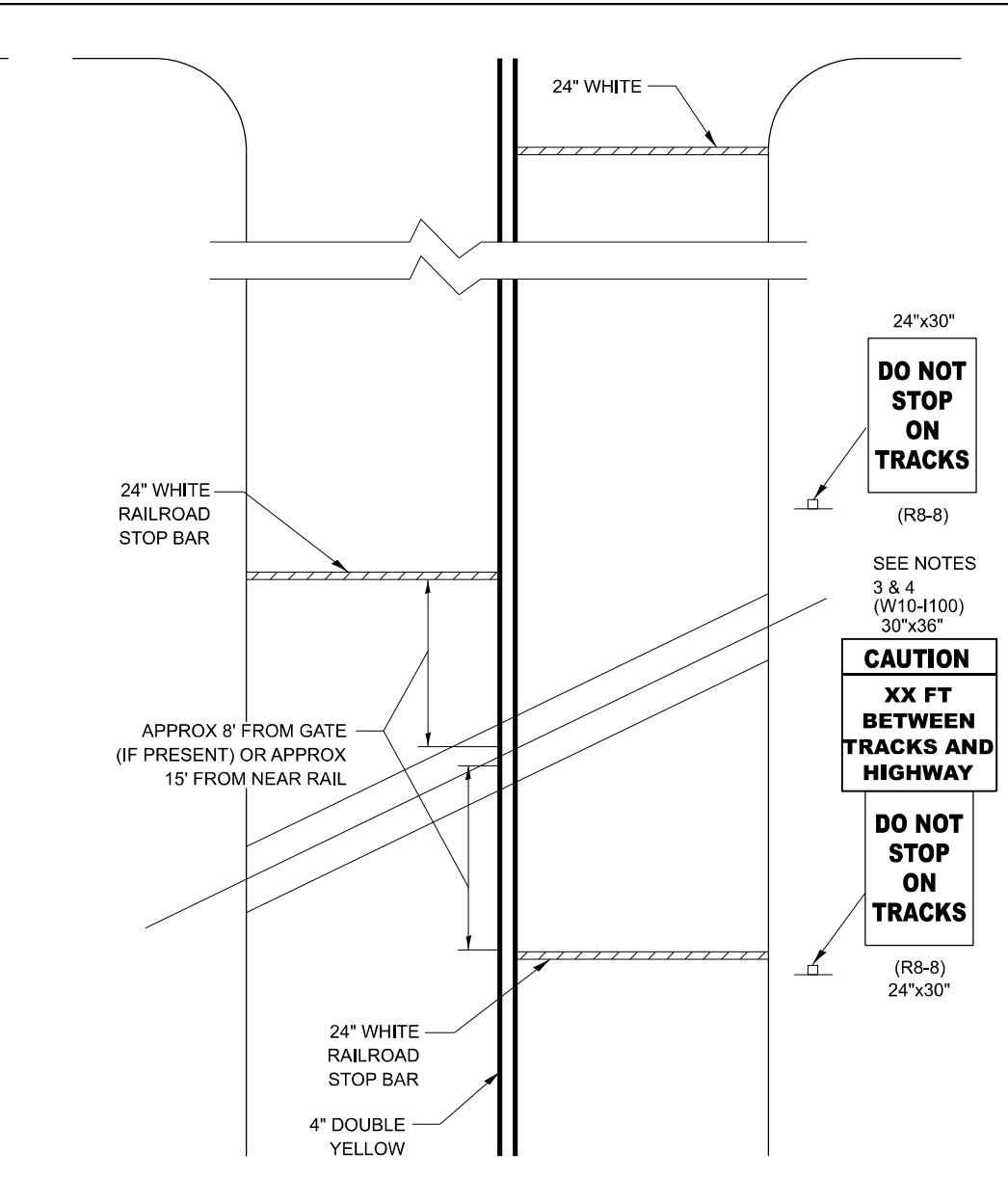

WITH NONSIGNALIZED INTERSECTION

- NOTES:
- PAVEMENT MARKINGS TO BE INSTALLED ONLY ON APPROACHES TO INTERSECTIONS CONTROLLED BY TRAFFIC SIGNALS WHICH ARE INTERCONNECTED WITH THE RAILROAD WARNING SIGNALS.
 - WHERE NEAR-SIDE TRAFFIC SIGNALS ARE USED THE PAVEMENT MARKINGS EXTEND TO THE INTERSECTION.
 - DISTANCE TO BE SHOWN ON SIGN MEASURED FROM A POINT 6 FEET FROM THE RAIL CLOSEST TO THE INTERSECTION OR FROM THE CLOSEST POINT ALONG THE EXIT GATE IF PRESENT OVER THE ROADWAY WHEN IN THE LOWERED POSITION TO THE STOP BAR OR CROSSWALK, WHICH EVER IS CLOSEST, ROUNDED DOWN TO NEAREST 5 FEET. WHERE THERE IS NO STOP LINE, MEASURE TO POINT WHERE DRIVER HAS A VIEW OF APPROACHING TRAFFIC.
 - THE CLEARANCE SIGN IS ALSO TO BE USED AS AN INTERIM MEASURE AT LOCATIONS WITH INTERCONNECTED INTERSECTION TRAFFIC SIGNALS WHERE IT IS PLANNED TO CHANGE THEM TO NEAR-SIDE SIGNALS AT A FUTURE TIME. IN THIS CASE, THE DISTANCE TO BE SHOWN ON THE SIGN IS MEASURED FROM THE EDGE OF THE STRIPED-OUT AREA INSTEAD OF 6 FEET FROM THE RAIL. THE SIGN IS TO BE REMOVED WHEN THE NEAR-SIDE SIGNALS ARE INSTALLED AND THE PAVEMENT MARKINGS EXTEND TO THE INTERSECTION.

USER NAME = ronald.woodshank DRAWN = RW PLOT SCALE = 100,000 / 1in. PLOT DATE = 8/24/2023	DESIGNED = RW	REVISED = ____	STATE OF ILLINOIS DEPARTMENT OF TRANSPORTATION	TYPICAL PAVEMENT MARKING			F.A. RTE.	SECTION	COUNTY	TOTAL SHEETS	SHEET NO.
	CHECKED = YP	REVISED = ____		SCALE: ____	SHEET 5 OF 8 SHEETS	STA. ____	TO STA. ____	VAR D 3 HT PVMNT MRK RPR 24-16	VARIOUS	15	12
	DATE = 7/28/2023	REVISED = ____		CONTRACT NO. 46635	ILLINOIS	FED. AID PROJECT					

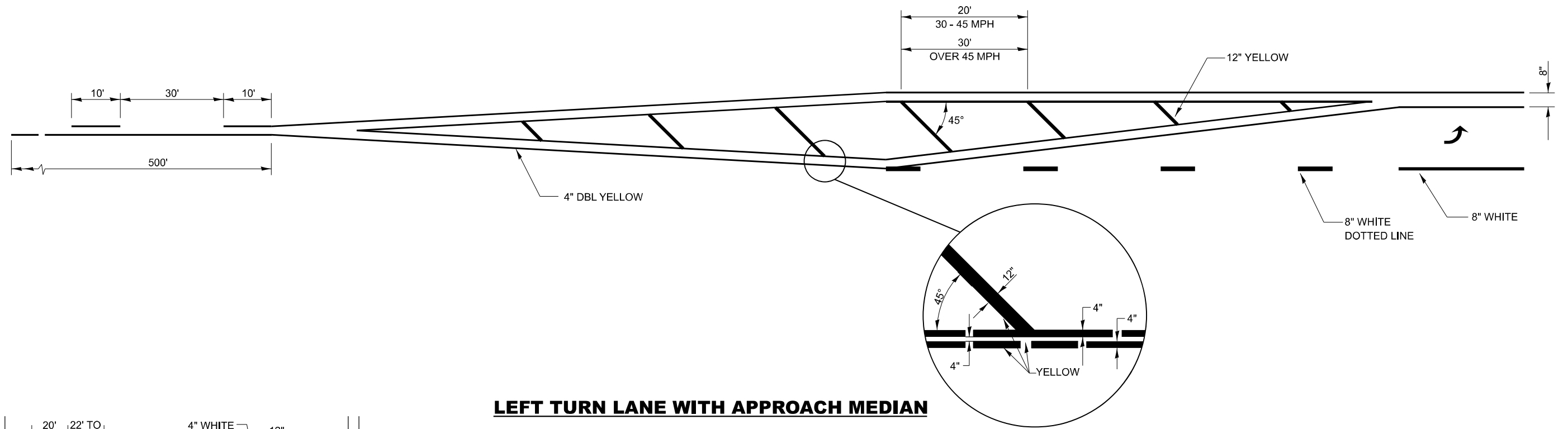

LEFT TURN LANE WITH APPROACH MEDIAN

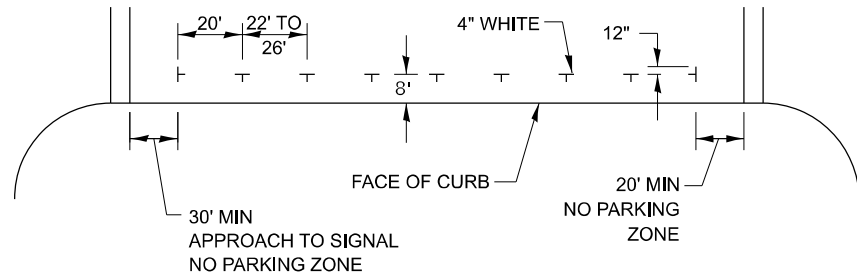

PREFERRED METHOD

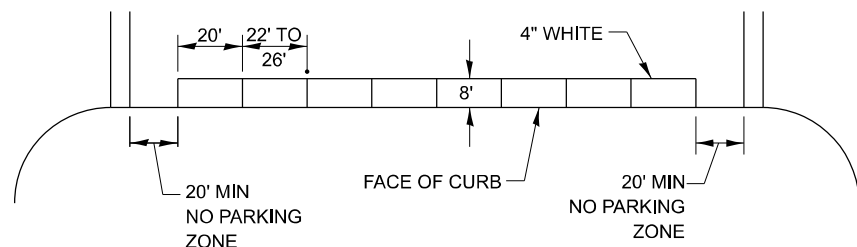

OPTION 2

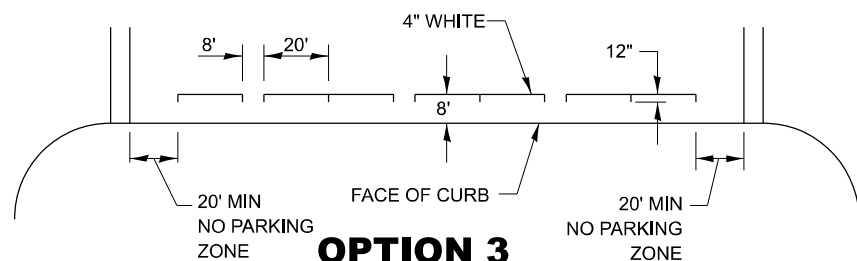

OPTION 3

TYPICAL PARKING SPACING

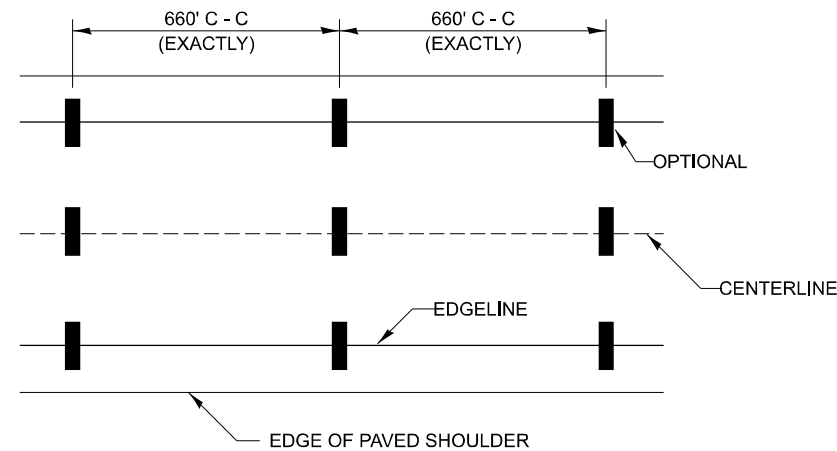

IT WILL BE NECESSARY TO HAVE A REPRESENTATIVE OF THE STATE POLICE PRESENT SO THAT THE ACCURACY OF MEASUREMENT CAN BE ATTESTED TO IN COURT.

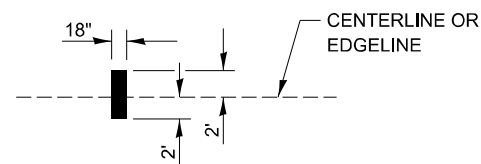

AERIAL SPEED CHECK ZONES

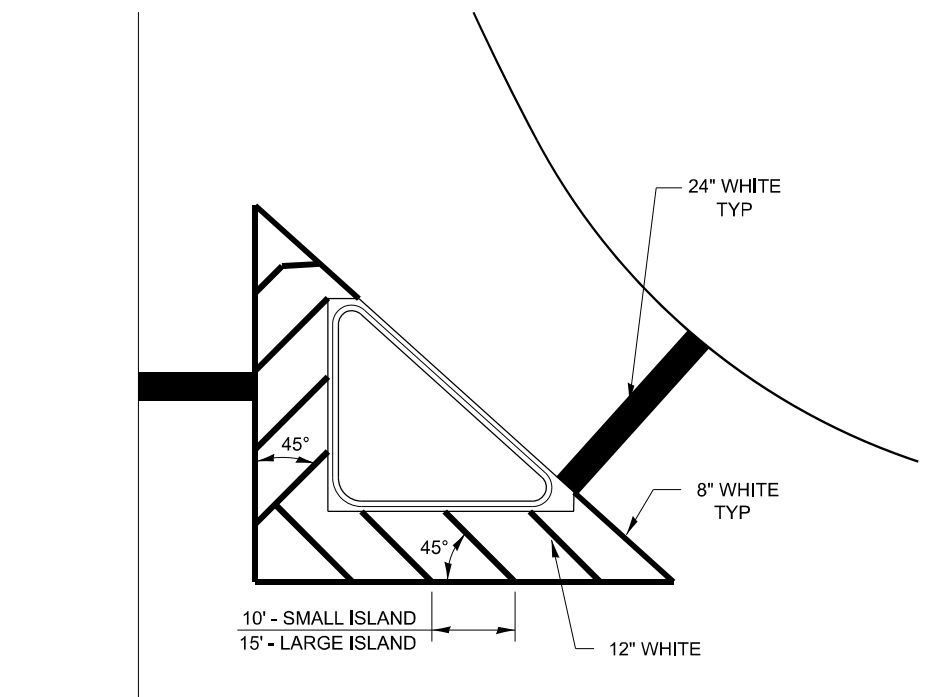

TYPICAL ISLAND

MODEL: D:\in\it... FILE NAME: ...

USER NAME = ronald.woodshank	DESIGNED - RW	REVISED -
DRAWN - RW	CHECKED - YP	REVISED -
PLOT SCALE = 100,000 / 1in.	DATE - 7/28/2023	REVISED -
PLOT DATE = 8/24/2023		

**STATE OF ILLINOIS
DEPARTMENT OF TRANSPORTATION**

TYPICAL PAVEMENT MARKING

SCALE: _____ SHEET 6 OF 8 SHEETS STA. _____ TO STA. _____

F.A. RTE.	SECTION	COUNTY	TOTAL SHEETS	SHEET NO.
VAR	D 3 HT PVMNT MRK RPR 24-16	VARIOUS	15	13
CONTRACT NO. 46635				
ILLINOIS FED. AID PROJECT				

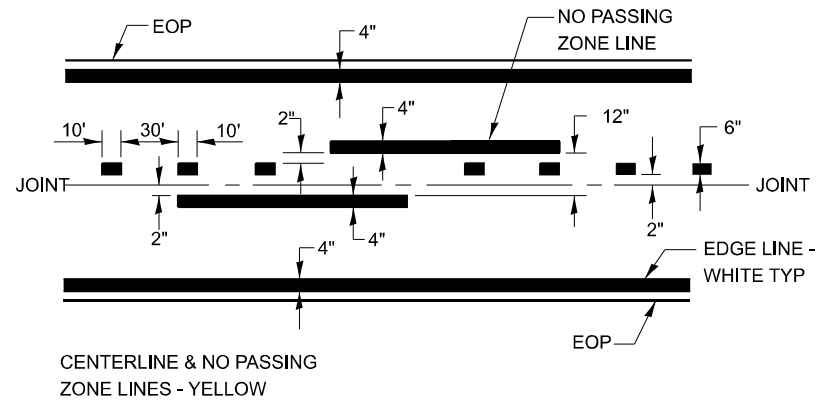

2 LANE

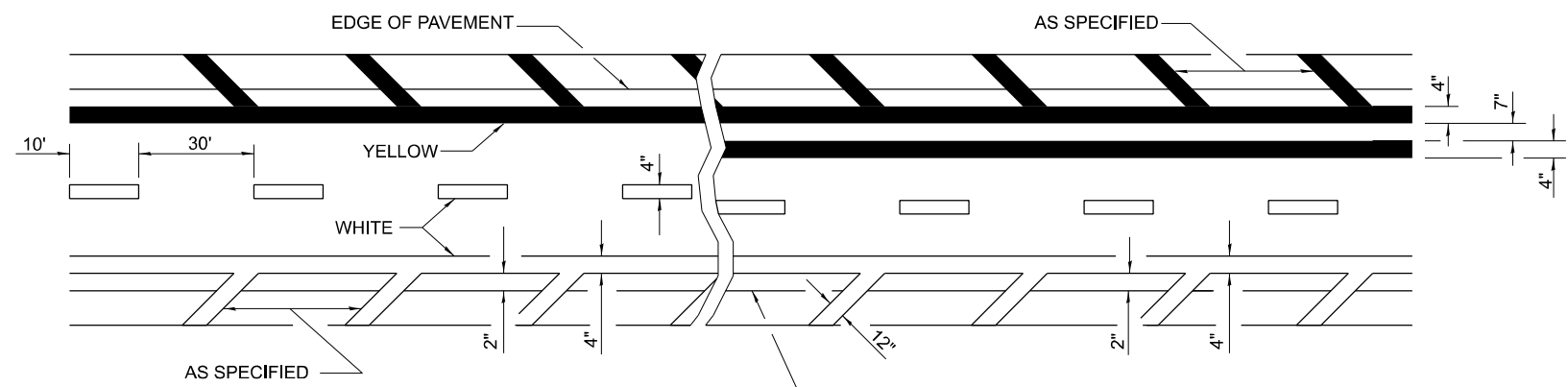

LANE AND EDGE LINES

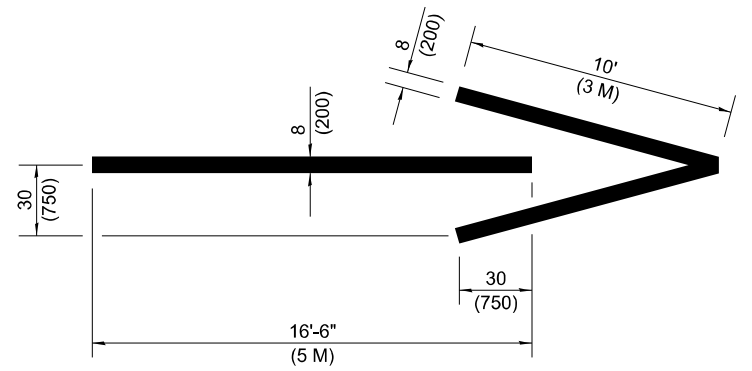

WRONG WAY ARROW

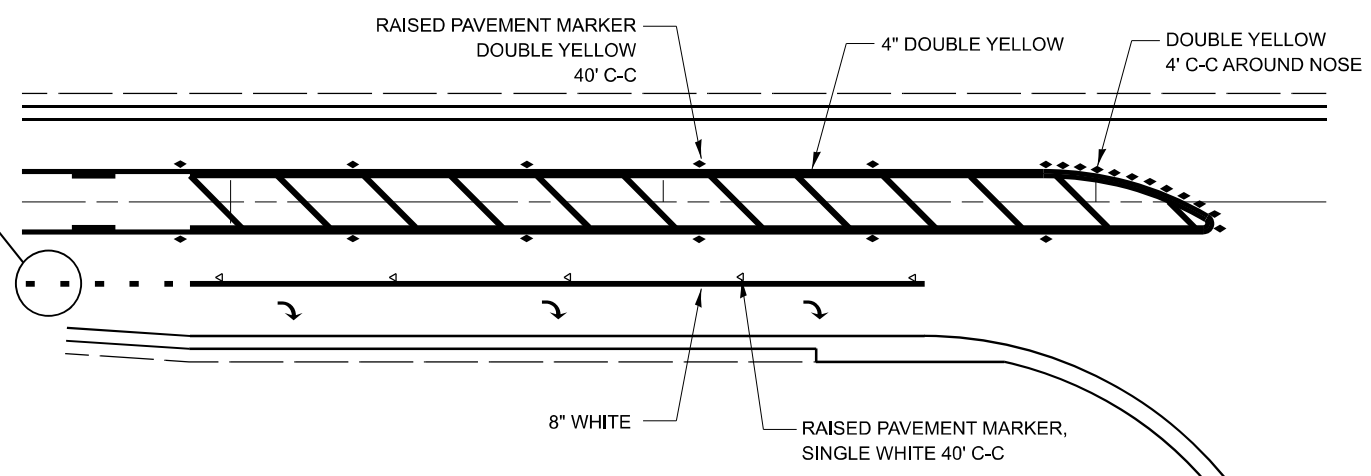
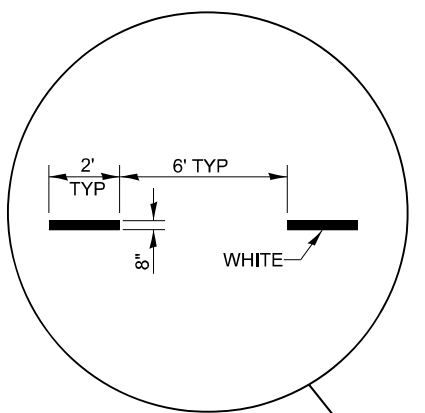

RAISED REFLECTIVE AND PAVEMENT MARKERS @ RIGHT TURN LANE

MODEL: D:\in\it... FILE NAME: ...

USER NAME = ronald.woodshank	DESIGNED - RW	REVISED - _____
DRAWN - RW	REVISOR - _____	
PLOT SCALE = 100,000' / 1in.	CHECKED - YP	REVISED - _____
PLOT DATE = 8/24/2023	DATE - 7/28/2023	REVISED - _____

**STATE OF ILLINOIS
DEPARTMENT OF TRANSPORTATION**

TYPICAL PAVEMENT MARKING

SCALE: _____ SHEET 7 OF 8 SHEETS STA. _____ TO STA. _____

F.A. RTE.	SECTION	COUNTY	TOTAL SHEETS	SHEET NO.
VAR	D 3 HT PVMNT MRK RPR 24-16	VARIOUS	15	14
CONTRACT NO. 46635			ILLINOIS FED. AID PROJECT	

MODEL: D:\in\it...
 FILE NAME: p:\work\pavement\pavement\DOT Office\District 3\ORD Project\346635\CAD\Sheet\46635 COVER.dgn

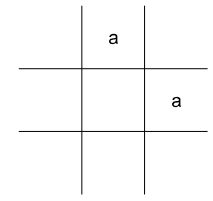
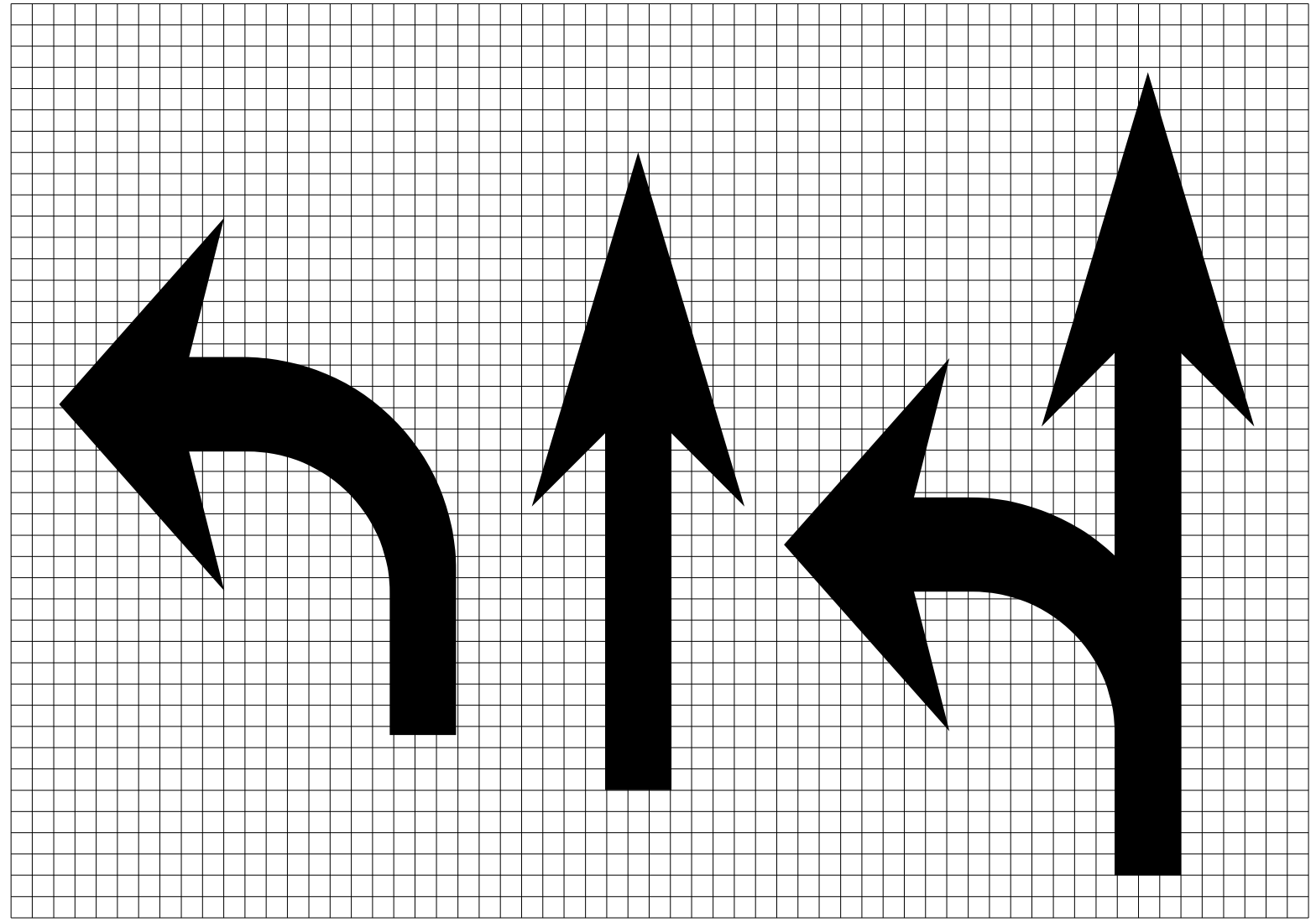

LEGEND HEIGHT	ARROW SIZE	a
6' (1.8 M)	SMALL	2.9 (74)
8' (2.4 M)	LARGE	3.8 (96)

THE SPACE BETWEEN ADJACENT LETTERS OR NUMERALS SHOULD BE APPROXIMATELY 3 (75) FOR 6' (1.8 M) LEGEND AND 4 (100) FOR 8' (2.4 M) LEGEND.

LETTER AND ARROW GRID SCALE

USER NAME = ronald.woodshank	DESIGNED - RW	REVISED - _____
PLOT SCALE = 100,000 / 1in.	DRAWN - RW	REVISED - _____
PLOT DATE = 8/24/2023	CHECKED - YP	REVISED - _____
	DATE - 7/28/2023	REVISED - _____

**STATE OF ILLINOIS
 DEPARTMENT OF TRANSPORTATION**

TYPICAL PAVEMENT MARKING

SCALE: _____ SHEET 8 OF 8 SHEETS STA. _____ TO STA. _____

F.A. RTE.	SECTION	COUNTY	TOTAL SHEETS	SHEET NO.
VAR	D 3 HT PVMNT MRK RPR 24-16	VARIOUS	15	15
			CONTRACT NO. 46635	
ILLINOIS FED. AID PROJECT				