**STRUCTURE GEOTECHNICAL REPORT
INTERSTATE 80 BRIDGES
OVER INTERSTATE 55
EX SNs 099-0044 AND 099-0045
PR SNs 099-8316 AND 099-8317
WILL COUNTY, ILLINOIS**

**For
Stantec**

**350 North Orleans Street, Suite 1301
Chicago, IL 60654**

**Submitted by
Wang Engineering, Inc.
1145 North Main Street
Lombard, IL 60148**

**Original Report: February 21, 2022
Revised Report: February 24, 2022, June 1, 2022, and August 8, 2022**

Technical Report Documentation Page

1. Title and Subtitle Structure Geotechnical Report Interstate 80 Bridges Over Interstate 55		2. Original Date: February 21, 2022 Revised Date: February 24, 2022, June 1, 2022, and August 8, 2022
		3. Report Type <input checked="" type="checkbox"/> SGR <input type="checkbox"/> RGR <input type="checkbox"/> Draft <input checked="" type="checkbox"/> Final <input checked="" type="checkbox"/> Revised
4. Route / Section / County/ District/ Region F.A.I 80 / 2021-154-R / Will / 1 / 1		5. IDOT Project No. / Contract No. D-91-038-22 / NA
6. PTB / Item No. 194/010	7. Existing Structure Number(s) SN 099-0044 and SN 099-0045	8. Proposed Structure Number(s) SN 099-8316 and SN 099-8317
9. Prepared by Wang Engineering, Inc. 1145 N Main Street Lombard, IL 60148	Contributor(s) Author: Azza Hamad, PE Nesam Balakumaran, P. Eng QC/QA: Corina Farez, PE, PG PM: Azza Hamad, PE	Contact (630) 953-9928 ext. 1021 nbalakumaran@wangeng.com
10. Prepared for Stantec 350 North Orleans Street Suite 1301 Chicago, IL, 60654	Design Engineer Dave Pieniasek, PE	Contacts (312) 262-2245 Dave.Pieniasek@stantec.com
11. Abstract Two new, two-span bridges will replace the existing four-span bridges carrying Interstate 80 over Interstate 55 in Will County, Illinois. The proposed structures will have back-to-back of abutments length of 245.7 feet and out-to-out widths ranging from 68.8 to 78.7 feet. The proposed east and west abutment cap base elevations are 600.30 and 602.91 feet, respectively, whereas the proposed pier cap base elevations are 575.02 and 576.52 feet at the westbound and eastbound piers, respectively. This report provides geotechnical recommendations for the design and construction of the proposed approach embankments, approach slabs, and bridge foundations. The pavement structure along I-80 consists of 16 to 21 inches of asphalt followed by 2 to 10 inches of concrete pavement over 12 to 47 inches of aggregate base, whereas the I-55 surface consists of 15 to 18 inches of asphalt pavement over 16 to 36 inches of aggregate base. Beneath the I-80 pavement structure, the general lithologic profile includes up to 23.0 feet of embankment materials consisting of stiff to hard silty clay to silty clay loam and silty loam fill overlying dense to very dense gravel to gravelly loam. Dolostone bedrock was encountered at elevations of about 576 to 572 feet. The groundwater level was measured at elevations ranging from 585 to 575 feet. The approach embankments behind the east and west abutments will undergo an estimated 0.3 inches of total long-term settlement under the new embankment loads. Global stability analyses at the embankments show FOS meeting the IDOT minimum requirement of 1.5. The maximum factored soil bearing resistance for the approach footings is 2,500 psf. The bridge abutments could be supported on driven piles. To support the integral abutments, driven HP12x53, HP 12x74, HP 14x73, and HP14x89 steel piles will provide 230 to 388 kips of factored resistance at total lengths of 29 to 35 feet. We do not anticipate the need for downdrag allowances on the piles. The pier could be supported on either rock-socketed drilled shafts, spread footings, or piles set in rock. Rock-socketed shafts have factored resistances of about 530 to 1,470 kips for 3.0- to 5.0-foot diameter sockets. Spread footings at the pier can be designed based on a maximum factored bearing resistance of 24 ksf. At the pier, HP12x53, HP 12x74, HP 14x73, and HP14x89 steel piles set in rock will provide about 542 to 914 kips of factored resistance.		
12. Path to archived file N:_WANGLegacy\SHARED\Netprojects\2553901\Reports\SGRs\Bridges\I-80 Over I-55\RPT_Wang_NSB_AZH_2553901_I80OverI55BridgesSGR_V04_20220808.pdf		

TABLE OF CONTENTS

1.0	INTRODUCTION	1
1.1	EXISTING STRUCTURES AND GROUND CONDITIONS	1
1.2	PROPOSED STRUCTURES	2
2.0	METHODS OF INVESTIGATION	3
2.1	FIELD INVESTIGATION	3
2.2	LABORATORY TESTING	4
3.0	INVESTIGATION RESULTS	4
3.1	LITHOLOGICAL PROFILE	4
3.2	GROUNDWATER CONDITIONS	6
4.0	FOUNDATION ANALYSIS AND RECOMMENDATIONS	6
4.1	SEISMIC DESIGN CONSIDERATIONS	7
4.2	APPROACH EMBANKMENTS AND SLABS	8
4.2.1	<i>Settlement</i>	8
4.2.2	<i>Global Stability</i>	8
4.2.3	<i>Approach Slabs</i>	8
4.3	STRUCTURE FOUNDATIONS	9
4.3.1	<i>Driven Piles</i>	9
4.3.2	<i>Drilled Shafts</i>	11
4.3.3	<i>Spread Footings</i>	12
4.3.4	<i>Piles Set in Rock</i>	13
4.3.4	<i>Lateral Loading</i>	14
4.4	STAGE CONSTRUCTION	16
5.0	CONSTRUCTION CONSIDERATIONS	17
5.1	SITE PREPARATION	17
5.2	EXCAVATION, DEWATERING, AND UTILITIES	17
5.3	FILLING AND BACKFILLING	18
5.4	EARTHWORK OPERATIONS	18
5.5	PILE INSTALLATION	18
5.6	DRILLED SHAFTS	19
6.0	QUALIFICATIONS	19

REFERENCES

EXHIBITS

- 1. *SITE LOCATION MAP*
- 2. *SITE AND REGIONAL GEOLOGY*
- 3. *BORING LOCATION PLAN*
- 4. *SOIL PROFILE*

APPENDIX A

- BORING LOGS*

APPENDIX B

- LABORATORY TEST RESULTS*

APPENDIX C

- BEDROCK CORE PHOTOGRAPHS*

APPENDIX D

- GLOBAL STABILITY ANALYSIS*

APPENDIX E

- GENERAL PLAN AND ELEVATION DRAWING*

APPENDIX F

- CROSS-SECTIONS*

LIST OF TABLES

Table 1: Recommended Seismic Design Parameters	7
Table 2: Preliminary Factored Loads and Proposed Pile Cap Elevations.....	9
Table 3: Estimated Pile Lengths and Tip Elevations for Steel H-Piles Driven to R_{NMAX}	11
Table 4: Estimated Drilled Shaft Resistances and Base Elevations (Rock-Socketed Shafts)	12
Table 5: Recommended Soil Parameters for Lateral Load Analysis at West Abutments.....	15
Table 6: Recommended Soil Parameters for Lateral Load Analysis at Piers.....	15
Table 7: Recommended Soil Parameters for Lateral Load Analysis at East Abutments.....	16
Table 8: Bedrock Parameters for Lateral Load Analysis.....	16

**STRUCTURE GEOTECHNICAL REPORT
INTERSTATE 80 BRIDGES
OVER INTERSTATE 55
EX SNS 099-0044 AND 099-0045
PR SNS 099-8316 AND 099-8317
WILL COUNTY, ILLINOIS
FOR
STANTEC**

1.0 INTRODUCTION

This report presents the results of our subsurface investigation, laboratory testing, geotechnical evaluations, and recommendations in support of the design and reconstruction of the existing bridges carrying eastbound (EX SN 099-0044) and westbound (EX SN 099-0045) Interstate 80 (I-80) over Interstate 55 (I-55) in Troy Township, Will County, Illinois. The project area is located in west central Will County, along I-80, just south of the Village of Shorewood. On the USGS *Channahon Quadrangle 7.5 Minute Series* map, the project is located at the limit between Section 27 and Section 28, Tier 35 N, Range 9 E of the Third Principal Meridian. A *Site Location Map* is presented as Exhibit 1. The bridge replacements are part of the proposed widening and reconstruction of I-80 from east of Ridge Road to west of Houbolt Road in Will County, Illinois. These bridges will be reconstructed as part of Contract INT-1.

The purpose of this investigation was to characterize the site soil and groundwater conditions, perform geotechnical analyses, and provide recommendations for the design and construction of the proposed bridge foundations, approach embankments, and approach slabs.

1.1 Existing Structures and Ground Conditions

Based on the *Bridge Condition Reports (BCRs)*, dated March 11, 2020 and provided by Stantec, Wang Engineering, Inc. (Wang) understands the existing bridges were originally built in 1960 as four-span structures supported by cast-in-place reinforced concrete stub abutment and multi-column piers. The piers are supported on spreads footings, whereas the abutments are supported on 35-ton capacity steel piles. The approach slabs and wingwalls are supported on timber piles driven to refusal. The existing bridges have lengths of 239.3 feet from back to back of abutments and out-to-out widths of 53.0 feet. Reinforced concrete wingwalls and 4-inch thick concrete slope walls are located at the ends of the structures. The structures were repaired in 1980, 1993, and 1999.

The site surface elevation is generally flat gently sloping westward toward DuPage River and steeper eastward toward Rock Run Creek. The bridge is about halfway between the two valleys. DuPage River runs south about 0.7 miles west of the new bridge and Rock Run Creek runs south about 0.6 miles east of the bridge. The ground surface is about 611.0 feet along the I-80 embankment near the bridge and at about 590 feet at the I-55 level.

In the project area (see Exhibit 2), about 20-foot thick mainly cohesive man-made ground, the roadway embankment, is placed over about 10 to 20 feet of overburden made up of low to moderate plasticity, medium to high strength, and low to moderate moisture content silty clayey diamicton resting over granular, very dense, low compressibility silty loam diamicton unconformably covers the bedrock (Bauer et al. 1991, Hansel and Johnson 1996, Leighton et al. 1948, Willman et al. 1971). The bedrock is made up of shaly dolostone. Top of bedrock is mapped at about 575.0 feet elevation. The site is located just north of the inactive Sandwich Fault Zone (Kolata 2005). The shallow bedrock is highly to moderately weathered and may show the presence of cavities more likely filled with fine sediment. There are no records of mining activity within the bridge site. Neither the overburden nor the upper bedrock is known to include significant sources of water supply (Woller and Sanderson 1983).

1.2 Proposed Structures

Based on the proposed *General Plan and Elevation Drawings* (Appendix E), provided by Stantec and dated August 3, 2022, Wang understands the existing four-span bridges will be removed and replaced with two new, two-span bridges with integral abutments and a pier. The new bridges will have back-to-back of abutments length of 245.7 feet and out-to-out widths of 68.8 to 78.7 feet to accommodate two 12-foot wide lanes, a 12-foot wide shoulder/future lane, a 12- to 16-foot wide ramp lane/auxiliary lane, 6-to 12-foot wide shoulders, and 1.4-foot wide parapets.

Based on the provided *Cross-sections* (Appendix F), the existing grade along I-80 is approximately 604 to 611 feet and the proposed back of abutment elevations are approximately 609.2 to 611.8 feet at the east and west abutments, respectively; therefore, the grade will be raised by up to 12 inches along each centerline at the west and east approaches, respectively. From the design drawings, we estimate the east and west abutments will be constructed a few feet behind the existing abutments, whereas the pier will be constructed in the same location as the existing center pier. About 3.0 to 5.0 feet of new fill will be placed along the existing median at the west and east approaches, respectively, to facilitate the inward widening of the bridges by about 24.0 feet at the north and south sides of the eastbound and westbound bridges.

We understand the side slopes along the west approach would be graded at slopes similar to the existing approach embankment side slopes. As per the *Cross-Sections* (Appendix F), the side slope on the south side of the east approach will be graded at a slope of 1:4 (V: H), and up to 4.0 feet of new fill will be placed along the existing east embankment's slope. The *GPE* (Appendix E) shows concrete end slopes graded at 1:2 (V: H) on the east and west ends.

2.0 METHODS OF INVESTIGATION

The following sections outline the subsurface and laboratory investigations performed by Wang.

2.1 Field Investigation

The subsurface investigation consisted of nine bridge borings, designated as 80/55-BSB-01 to 80/55-BSB-09, drilled by Wang between January and February of 2022. The borings were drilled from elevations of 588.0 to 611.2 feet and were advanced to depths of 27.0 to 53.0 feet bgs. The as-drilled northings and eastings were acquired with a mapping-grade GPS unit. Stations, offsets, and elevations were provided by Stantec. Boring location data are presented in the *Boring Logs* (Appendix A) and the as-drilled boring locations are shown in the *Boring Location Plan* (Exhibit 3).

Truck-mounted drilling rigs, equipped with hollow stem augers, were used to advance and maintain open boreholes. Mud rotary drilling techniques were used from 10.0 feet bgs to advance the bridge boreholes drilled from the I-80 embankment. Soil sampling was performed according to AASHTO T206, "*Penetration Test and Split Barrel Sampling of Soils.*" The soil was sampled at 2.5-foot intervals to 30.0 feet bgs and at 5.0-foot intervals thereafter to the boring termination depth. Bedrock cores were collected from all the borings in 5- and 10-foot runs with an NWD4-sized core barrel. Soil samples collected from each sampling interval were placed in sealed jars and rock cores were placed into marked core boxes and transported to the laboratory for further examination and testing.

Field boring logs, prepared and maintained by Wang field engineers, included lithological descriptions, visual-manual soil (IDH Textural) classifications, results of Rimac and pocket penetrometer unconfined compressive strength tests, and results of Standard Penetration Tests (SPT) recorded as blows per 6 inches of penetration.

Groundwater levels were measured while drilling and at completion of drilling the borings along I-55. Since mud rotary drilling techniques were used to advance and maintain open boreholes from the I-80 embankment, groundwater level recordings were not available at completion of the borings. Prior to being backfilled, Boring 80/55-BSB-07 drilled from I-80 was left open to record

24-hour water level readings. Each borehole location was backfilled upon completion with lean grout, soil cuttings, and/or bentonite chips and, where necessary, the pavement surface was restored as much as possible to its original condition.

2.2 Laboratory Testing

The soil samples were tested in the laboratory for moisture content (AASHTO T265). Atterberg limits (AASHTO T89 and T90) and particle size analysis (AASHTO T88) tests were performed on selected samples. Unconfined compressive strength tests were performed on selected bedrock cores. Field visual descriptions of the soil samples were verified in the laboratory and index tested soils were classified according to the IDH soil Classification System. The laboratory test results are shown in the *Boring Logs* (Appendix A) and in the *Laboratory Test Results* (Appendix B).

3.0 INVESTIGATION RESULTS

Detailed descriptions of the soil conditions encountered during the subsurface investigation are presented in the attached *Boring Logs* (Appendix A) and in the *Soil Profile* (Exhibit 4). Please note that strata contact lines represent approximate boundaries between soil types. The actual transition between soil types in the field may be gradual in horizontal and vertical directions.

Our subsurface investigation results fit into the local geologic context. The borings drilled in the project area revealed the native sediments consists of silty clay to silty clay loam diamicton (unit 2) with occasional lenses of silt and sand, over sand and gravel outwash (unit 3) resting over weathered bedrock. Unit 3 is water-bearing with seasonal fluctuation. Top of dolostone bedrock was encountered at elevations of 555.4 to 585.3 feet (12.0 to 38.0 feet bgs) as predicted based on geologic data. The borings did not expose the presence of sediment filled cavities; however, the geologic site information indicates the possible presence of cavities.

3.1 Lithological Profile

Borings 80/55-BSB-01, 80/55-BSB-03, 80/55-BSB-07, and 80/55-BSB-09 were drilled along the I-80 shoulders and revealed the pavement structure consists of 16 to 21 inches of asphalt followed by 2 to 10 inches of concrete pavement overlying 12 to 47 inches of damp, sand to gravelly sand aggregate base with cobble fragments. Borings 80/55-BSB-04 and 80/55-BSB-06 were drilled along the I-80 median and sampled 2 to 12 inches of silty clay to silty clay loam topsoil. Borings 80/55-BSB-02, 80/55-BSB-05, and 80/55-BSB-08, drilled along the I-55 shoulders, showed the pavement structure consists of 15 to 18 inches of asphalt overlying 16 to 36 inches of damp sandy gravel to crushed stone aggregate base. In descending order, the general lithologic succession encountered beneath the

pavement or topsoil includes: 1) man-made ground (fill); 2) stiff to hard silty clay to silty clay loam and silty loam; 3) dense to very dense gravel to gravelly loam; and 4) medium strong to strong, very poor to good quality dolostone.

1) Man-made ground (fill)

Beneath the topsoil or pavement structure, the borings drilled along I-80 encountered up to 23.0 feet of cohesive fill. The cohesive fill consists of stiff to hard, black, brown, and gray silty clay to silty clay loam, clay loam, and silt to silty loam with unconfined compressive strength (Q_u) values of 1.1 to 6.0 tsf and moisture content values of 13 to 25%. Laboratory index testing on samples from this layer showed liquid limit (LL) values of 28 to 36% and plastic limit (PL) values of 15 to 17%. Construction debris and brick fragments were noted within the fill in Boring 80/55-BSB-01. Borings 80/55-BSB-03 and 80/55-BSB-09, drilled along the east end of I-80, sampled about 2.5 to 6.0 feet of loose to medium dense, damp to wet, brown gravelly silty loam to loam fill with cobble fragments. The granular fill is characterized by an SPT N-value of 12 blows per foot and moisture content values of 11 to 14%. Rig chatter indicating the presence of cobbles was noted at a depth of 20.0 feet within the fill in Boring 80/55-BSB-09.

An 18-inch thick layer of buried, black silty clay loam topsoil with a moisture content value of 21% was sampled beneath the fill in Boring 80/55-BSB-06. The presence of this layer most likely indicates the boundary between fill and natural soils.

2) Stiff to hard silty clay to silty clay loam and silty loam

Beneath the fill, at elevations of 580 to 589 feet, the borings advanced through 4.0 to 11.0 feet of stiff to hard, brown to gray clay, silty clay to silty clay loam, and silty loam characterized by Q_u values of 1.1 to 8.8 tsf and moisture content values of 14 to 30%. Laboratory index testing on samples from this layer showed LL values of 25 to 52% and PL values of 15 to 19%. A 1.0- to 3.0-foot thick brown, wet sand to sandy loam lens was encountered in Borings 80/55-BSB-02 and 80/55-BSB-08 at an elevation of 580 feet. Rig chatter, indicating the possible presence of cobbles was noted at an elevation of 578 feet (depth of 30.0 feet bgs) within Boring 80/55-BSB-03. Shale fragments were noted at a depth of 14.0 feet within this layer in Boring 80/55-BSB-02.

3) Dense to very dense gravel to gravelly loam and silt

At elevations of 578 to 579 feet, Borings 80/55-BSB-01, 80/55-BSB-04, and 80/55-BSB-07 advanced through 4.0 to 5.0 feet of dense to very dense, gray, damp gravel to gravelly loam and silt with cobble fragments. This soil unit has N-values of 34 to 58 blows per foot and moisture content values of 9 to 12%.

4) *Medium strong to strong, very poor to good quality dolostone*

At elevations of 577 to 573 feet, the borings advanced through 0.5 to 2.0 feet of very dense, weathered bedrock and/or very dense shale fragments. This soil unit has N-values of greater than 50 blows per 5 inch and a moisture content value of 14%. Hard drilling and rig chatter was noted at elevations of 577 to 574 feet (depths of 12.0 to 36.5 feet) in Borings 80/55-BSB-05, 80/55-BSB-06, and 80/55-BSB-07.

At elevations of 576 to 572 feet (depths of 13.0 to 38.0 feet bgs), the borings encountered and cored medium strong to strong, very poor to good quality, slightly to moderately weathered shaly dolostone bedrock. The Rock Quality Designation (RQD) ranges from 0 to 93% and uniaxial compressive strength tests revealed Q_u values of 5,242 to 9,193 psi. The bedrock core data is shown in the *Bedrock Core Photographs* (Appendix C).

3.2 Groundwater Conditions

Along I-80, groundwater was encountered while drilling Boring 80/55-BSB-07 at an elevation of 575 feet (35.5 feet bgs) within the dense to very dense gravelly loam layer. Along I-55, groundwater was encountered while drilling Borings 80/55- BSB-02 and 80/55-BSB-08 at elevations of 583 to 580 feet (5.5 to 8.0 feet bgs). At the completion of drilling, Borings 80/55-BSB-02 and 80/55-BSB-08 recorded groundwater at an elevation of 578 feet (depths of 10.0 to 11.0 feet bgs) within the loose dense sandy loam layer. At the end of drilling, the mud from Boring 80/55-BSB-07 was flushed out and left open to measure the 24-hour groundwater level. Due to weather and safety conditions, the earliest groundwater level was recorded after 180 hours, and was recorded at an elevation of 585 feet (25.5 feet bgs). It should be noted that groundwater levels might change with seasonal rainfall patterns and long-term climate fluctuations or may be influenced by local site conditions. Additionally, water perched within the upper granular fill layers maybe encountered.

4.0 FOUNDATION ANALYSIS AND RECOMMENDATIONS

The *Cross-Section* drawings (Appendix F) indicate the grade along I-80 will be raised by up to 12 inches along west and east approach centerlines. We understand the east and west integral abutments will be constructed a few feet behind the existing abutments, whereas the pier will be constructed on the same location as the existing center pier. About 3.0 to 5.0 feet of new fill will be placed along the existing median at the west and east bridge approaches, respectively, to facilitate the inward widening of the bridges by about 24.0 feet.

We understand the side slopes along the west approach embankment would be graded at slopes similar to the existing approach embankment side slopes. As per the *Cross-Sections* (Appendix F), the side slope on the south side of the east approach will be graded at a slope of 1:4 (V: H), and up to 4.0 feet of new fill will be placed along the existing east embankment’s slope. The *GPE* (Appendix E) shows concrete end slopes graded at 1:2 (V: H) on the east and west ends.

Wang recommends supporting the integral abutments on driven pile foundations and supporting the pier on either rock-socketed drilled shafts, shallow foundations on bedrock, or piles set in rock. Supporting the abutment substructures on shallow foundations is not feasible due to the large loads anticipated from the abutments and drilled shaft foundations are not approved for use with integral abutments (IDOT 2020a). Geotechnical evaluations and recommendations for the approach embankments, approach slabs, and substructure foundations are included in the following sections.

4.1 Seismic Design Considerations

The seismic site class was determined in accordance with the IDOT *Geotechnical Manual* (IDOT 2020a). The soils within the top 100 feet have a weighted average S_u value of 4.42 ksf (Method C controlling) and the results classify the site in the Seismic Site Class C. The project location belongs to the Seismic Performance Zone 1 (IDOT 2020a). The seismic spectral acceleration parameters recommended for design in accordance with the AASHTO *LRFD Bridge Design Specifications* (AASHTO 2020) are summarized in Table 1. According to the IDOT *Bridge Manual* (IDOT 2012), liquefaction analysis is not required for sites located in Seismic Performance Zone 1.

Table 1: Recommended Seismic Design Parameters

Spectral Acceleration Period (sec)	Spectral Acceleration Coefficient ¹⁾ (% g)	Site Factors	Design Spectrum for Site Class C ²⁾ (% g)
0.0	PGA= 4.9	$F_{pga}= 1.2$	$A_s= 5.9$
0.2	$S_s= 10.6$	$F_a= 1.2$	$S_{DS}= 12.7$
1.0	$S_1= 4.0$	$F_v=1.7$	$S_{D1}= 6.8$

1) Spectral acceleration coefficients based on Site Class C

2) Site Class C Spectrum to be included on plans; $A_s = PGA * F_{pga}$; $S_{DS} = S_s * F_a$; $S_{D1} = S_1 * F_v$

4.2 Approach Embankment and Slabs

Wang has performed evaluations of the settlement and global stability of the approach embankments. The drawings indicate the grade along the I-80 approach embankments near the bridge will be raised by up to 12 inches along each centerline. About 3.0 to 5.0 feet of new fill will be placed along the existing median at the west and east approaches, respectively, to facilitate the inward widening of the bridges by about 24.0 feet. We understand the side slopes along the west approach embankment would be graded at slopes similar to the existing approach embankment side slopes. The side slope on the south side of the east approach will be graded at a slope of 1:4 (V: H), and up to 4.0 feet of new fill will be placed along the existing east embankment's slope.

4.2.1 Settlement

To facilitate the bridge widenings, up to 5.0 feet of new fill will be placed along the existing medians and up to 4.0 feet of new fill will be placed along the existing east approach embankment slope. Settlement estimates have been made based on correlations to measured index properties obtained from the laboratory tests (Appendix B). Based on the soil conditions, we estimate the foundation soils at the approaches will undergo up to 0.3 inch of long-term consolidation settlement under the applied load of the new approach embankment fill material. These settlements are appropriate for the construction of the approach slabs and we do not anticipate downdrag allowances for the proposed abutment piles.

4.2.2 Global Stability

The global stability of the approach embankment side slopes was analyzed at the critical sections based on the soil profile described in Section 3.1 and the information provided in the *General Plan and Elevation* and *Cross-sections* (Appendixes E and F). We also analyzed the stability of the end slope. The analysis discounts the beneficial effect of the abutment piles. The minimum required FOS for both short (undrained) and long-term (drained) conditions is 1.5 (IDOT 2012). *Slide v6.0* evaluation exhibits employing the Bishop Simplified method of analysis are shown in Appendix D. The FOS values meet the minimum requirement.

4.2.3 Approach Slabs

We assume the approach slabs will be supported on spread footing foundations (IDOT 2012). Based on the design drawings and soil conditions revealed in Borings 80/55-BSB-01, 80/55-BSB-03, 80/55-BSB-04, 80/55-BSB-06, 80/55-BSB-07, and 80/55-BSB-09, the approach footings will be supported mainly on the new fill to be placed along the approaches. We estimate the fill has a maximum factored soil bearing resistance of 2,500 psf for a new fill with unconfined compressive

strength of 1 tsf and calculated for a geotechnical resistance factor (Φ_b) of 0.45 (AASHTO 2020). The settlement of approach footings estimated to be less than 1.0 inch.

4.3 Structure Foundations

The soil conditions along the structures show stiff to hard clayey soils followed by dense to very dense gravel to gravelly loam and silt overlying dolostone bedrock. Wang recommends supporting the integral abutments on driven steel H-piles. Considering the presence of shallow bedrock at Borings 80/55-BSB-02, 80/55-BSB-05, and 80/55-BSB-08 the pier could be supported on either rock-socketed drilled shafts, shallow foundations, or piles set in rock.

The preliminary factored loading information provided by Stantec on February 3, 2022 and proposed abutment cap base elevations as shown in the *GPE* are summarized in Table 2.

Table 2: Preliminary Factored Loads and Proposed Pile Cap Elevations

Direction	Substructure	Pile Cap Elevations (feet)	Total Factored Load (kips)
Eastbound	West Abutment	603.83	2386
	Pier	581.00	5638
	East Abutment	601.06	2324
Westbound	West Abutment	603.83	2386
	Pier	581.00	5638
	East Abutment	601.06	2324

4.3.1 Driven Piles

IDOT specifies the maximum nominal required bearing (R_{NMAX}) for each pile and states the factored resistance available (R_F) for steel H-piles should be based on a geotechnical resistance factor (Φ_G) of 0.55 (IDOT 2012). Nominal tip and side resistance were estimated using the methods and empirical equations presented in the latest *IDOT Geotechnical Pile Design Guide* (IDOT 2020a). Based on the loads provided by Stantec and the proposed width of the substructures, the load per pile at the abutments will range between about 89 and 277 kips for a single row of piles spaced at 3- to 8-feet.

Based on IDOT standards, piles with greater than 0.4-inch of relative settlement along the sides require allowances for downdrag loads. We estimate that less than 0.4 inch of settlement will remain

following the construction of the embankment and subsequent pile driving. We estimate that downdrag allowances will not be required for the abutment piles.

The foundation soils within 10.0 feet below the abutment pile cap elevations consist of very stiff to hard clayey soils with average Q_u values of greater than 3.0 tsf. In accordance with the *All Bridge Designers Memo 19.8* (IDOT 2019), when the average soil strengths at an integral abutment exceed 3.0 tsf, the piles at the abutments should be precored for a depth of 10.0 feet below the abutment cap elevation and backfilled with bentonite having a Q_u value of 1.0 tsf to increase pile flexibility (IDOT 2019). The pile capacity evaluations have been performed assuming pile driving begins about 10.0 feet below the proposed abutment pile cap elevations.

The R_F , R_N , estimated pile tip elevations, and pile lengths for HP12x53, HP 12x74, HP 14x73, and HP 14x89 steel H-piles for the abutments are summarized in Table 3. The pile lengths shown in Table 3 include a 2-foot pile embedment into the abutment pile cap elevations as shown on the *GPE* (Appendix E) and the precored length of the pile.

High blow counts, sampler refusal, rig chatter, and hard drilling were noted within the borings below an approximate elevation of 580 feet indicating the presence of cobbles. As such, pile shoes should be used for piles driven to or below an elevation of 580 feet to avoid damage to the piles. Additionally, to achieve the maximum nominal required bearing at the abutments, the analysis shows the H-piles would need to be driven about 1.0 to 3.0 feet into the weathered bedrock and/or shaly dolostone. In these instances, the piles should be considered end bearing and designed for the maximum capacity of the pile. IDOT generally recommends that H-piles be driven to their maximum nominal required bearing. Table 3 provides estimated pile tip elevations and pile lengths for HP 12x53, HP12x74, HP 14x73, and HP14x89 steel H-piles driven to maximum nominal bearing.

Based on the geometry shown in the *GPE* (Appendix E), the existing abutments may conflict with driving some of the piles. The proposed abutment pile locations should be selected to miss the existing footings.

Table 3: Estimated Pile Lengths and Tip Elevations for Steel H-Piles Driven to R_{NMAX}

Structure Unit (Reference Boring)	Pile Cap Base Elevations (feet)	Pile Size	Maximum Nominal Bearing, R_N (kips)	Factored Geotechnical Loss (kips)	Factored Geotechnical Load Loss (kips)	Factored Resistance Available, R_F (kips)	Total Estimated Pile Length ⁽¹⁾ (feet)	Estimated Pile Tip Elevation (feet)
Westbound and Eastbound West Abutments (80/55-BSB-01, 80/55-BSB-04, and 80/55-BSB-07)	603.83	HP 12x53	418	0	0	230	34	571
		HP 12x74	589	0	0	324	35	570
		HP 14x73	578	0	0	318	35	570
		HP 14x89	705	0	0	388	35	570
Westbound and Eastbound East Abutments (80/55-BSB-03, 80/55-BSB-06, and 80/55-BSB-09)	601.06	HP 12x53	418	0	0	230	29	573
		HP 12x74	589	0	0	324	30	572
		HP 14x73	578	0	0	318	30	572
		HP 14x89	705	0	0	388	30	572

(1) Pile lengths were estimated primarily based on more conservative median Borings 80/55-BSB-04 and 80/55-BSB-06.

4.3.2 Drilled Shafts

The piers could be supported on drilled shafts socketed 5.0-feet into the bedrock. As per the 2012 IDOT *Bridge Manual*, drilled shafts extending into rock, in most cases, should be designed utilizing only end bearing or side resistance in rock, whichever is larger. For shafts socketed into the bedrock less than 10-foot long, we estimate the end bearing will give more capacity than the side resistance. Therefore, we recommend considering only the end bearing resistance. The shafts should be designed for end bearing with a tip resistance factor (ϕ_{stat}) of 0.50 (AASHTO 2020). Above the bedrock, the shafts should have diameters 6 inches larger than the sockets.

The bedrock resistance was evaluated in accordance with the Geologic Strength Index (GSI) method provided by AASHTO (2020). The R_F , R_N , and estimated base elevations for rock-socketed shafts are summarized in Table 4. The shaft lengths were estimated assuming the shafts start from the bottom of pile cap at the pier location shown on the GPE (Appendix E). For the anticipated loads (Table 2), we estimate shaft settlements of less than 0.5 inch.

Due to the presence of groundwater and the possible presence of granular soils above the bedrock, the recommended construction method for shafts socketed into bedrock is to install casing to the top of

the rock to maintain clean, open shafts during excavation. Loss of water circulation was not noted while coring, however, cavities are known to be present in this area, as discussed in Section 1.1. The quality of bedrock at the piers should be verified during construction. A value engineering analysis is recommended to select the most suitable type of foundation system at the pier.

Table 4: Estimated Drilled Shaft Resistances and Base Elevations (Rock-Socketed Shafts)

Structure Unit (Reference Boring)	Shaft Cap Base Elevations ⁽¹⁾ (feet)	Top of Bedrock Elevation (feet)	Socket Diameter (feet)	Nominal Unit Resistance (ksf)	Nominal Resistance, R _N (kips)	Factored Resistance Available, R _F (kips)	Total Socket Length (feet)	Estimated Total Shaft Length ⁽²⁾ (feet)
Westbound and Eastbound Piers (80/55-BSB-02, 80/55-BSB-05, and 80/55-BSB-08)	581.0	576.0 to 574.0	3.0		1060	530		
			4.0	150	1880	940	5.0	12.0
			5.0		2940	1470		

(1) Shaft cap base elevations as shown on the GPE at the proposed pier location.

(2) Total shaft lengths were measured from the proposed cap base elevation at the pier location.

4.3.3 Spread Footings

A spread footing supported on bedrock could be considered at the pier locations. The top of the bedrock elevation at the piers, as noted in Borings 80/55-BSB-02, 80/55-BSB-05, and 80/55-BSB-08, ranges from elevations of 576 to 574 feet or about 5.0 to 7.0 feet below the proposed bottom of footing elevation of 581.0 feet shown on the GPE (Appendix E). It is recommended that the bottom of the pier spread footing be placed a minimum of 6 inches below the top of the bedrock (IDOT 2012). The quality of bedrock at the pier should be verified during construction.

Considering the proposed removal of the existing pier columns and footings, construction of spread footings supported on bedrock at the pier locations will require excavations of up to 14.0 feet. Due to the hard soils and shallow bedrock at the pier location, we anticipate *Temporary Soil Retention Systems* will be needed for the removal and replacement of the piers. Additionally, the pier excavation will encounter groundwater and will require dewatering efforts. A value engineering analysis is recommended to select the most suitable type of foundation system at the pier.

According to Section 10.6.3.2.2 of the AASTHO LRFD *Bridge Design Specifications* (AASHTO 2020), the recommended bearing resistance for spread footings should be determined using empirical correlations with the Geomechanics RMR system. Based on our analysis, we estimate a factored bearing resistance of 24 ksf, considering a resistance factor of 0.45 (AASHTO 2020). The factored

bearing resistance shall not be taken to be greater than either the unconfined compressive strength of rock or the factored compressive resistance of the footing concrete (AASHTO 2020). The laboratory rock unconfined compressive strength results ranged from 5,242 to 8,775 psi (754 to 1263 ksf) and the factored nominal resistance of the concrete is 151 ksf based on the nominal concrete resistance as provided on the GPE of 3.5 ksi (504 ksf). Thus, the recommended bearing resistance of 24 ksf should be used for the design.

As per Section 10.6.2.4.4, for footings bearing on fair to very good rock, elastic settlements may be assumed to be less than 0.5 inches (AASHTO 2020). However, since the RQD value at the pier location is about 0 to 18% and the rock within the top 5.0 feet does not meet the fair to very good criteria, a settlement analysis was conducted. For our settlement evaluations, we assumed a footing width of 7.0 feet similar to the existing bridge, a length of 68.8 feet, and no eccentric loads. Based on the proposed factored load and assumed dimensions, we estimate a settlement of less than 0.5 inches. The recommended friction coefficient between concrete and bedrock materials is 0.7 (AASHTO 2020).

4.3.4 Piles Set in Rock

Piles drilled and set into bedrock could also be considered to increase axial capacity and provide sufficient resistance to lateral loads at the pier location. The top of the bedrock elevation at the pier, as noted in Borings 80/55-BSB-02, 80/55-BSB-05, and 80/55-BSB-08, ranges from elevations of 576 to 574 feet or about 5.0 to 7.0 feet below the proposed bottom of pile cap elevation of 581.0 feet shown on the GPE (Appendix E). The socket diameter should be specified in 6-inch increments and be just large enough to allow a pile to be placed into the socket with sufficient room to permit placement of concrete such that it completely encases the pile. The socket length should be checked to determine if it adequately carries the lateral load and, if necessary, the socket length can be increased to carry the lateral load (IDOT 2020).

As per the IDOT *Geotechnical Manual* (IDOT 2020), the design axial capacity of a pile set in rock can be larger than the maximums allowed in the IDOT *Bridge Manual* (IDOT 2012) for driven piles. This is because piles set in rock are not subjected to high driving stresses, which limit the maximum nominal capacity of driven piles. The maximum nominal capacity of driven H-piles is limited to 54% of its yield strength, while the nominal capacity of piles set in rock is 100% of its yield strength. Additionally, piles set in rock use a more favorable resistance factor of 0.7 for non-driven undamaged piles according to Article 6.5.4.2 of the “*AASHTO LRFD Bridge Design Specifications*” (AASHTO 2020) compared to 0.55 used for driven piles, where the nominal driven bearing is determined with

the WSDOT dynamic formula (IDOT 2020). The R_F , R_N for HP12x53, HP 12x74, HP14x73, and HP 14x89 along with approximate top of bedrock elevations are summarized in Table 5.

Table 5: Estimated Resistances for Piles Set in Rock

Structure Unit (Reference Boring)	Proposed Pile Cap Base Elevations ⁽¹⁾ (feet)	Approximate Top of Bedrock Elevation (feet)	Pile Size	Cross-sectional Area (square inches)	Nominal Resistance, R_N (kips)	Factored Resistance Available, R_F (kips)
Westbound and Eastbound Piers (80/55-BSB-02, 80/55-BSB-05, and 80/55-BSB-08)	581.0	576.0 to 574.0	HP 12x53	15.49	775	542
			HP12x74	21.80	1090	763
			HP14x73	21.40	1070	749
			HP 14x89	26.11	1305	914

(1) Pile cap base elevations as shown on the GPE at the proposed pier location.

Due to the presence of groundwater and the possible presence of granular soils above the bedrock, the recommended construction method for piles socketed into bedrock, similar to that of shaft construction, is to install casing to the top of the rock to maintain clean open holes during excavation. Loss of water circulation was not noted while coring, however, cavities are known to be present in this area, as discussed in Section 1.1. The quality of bedrock at the pier should be verified during construction. A value engineering analysis is recommended to select the most suitable type of foundation system at the pier.

The pile installation should be as per IDOT Section 512, *Piling* (IDOT 2022). Based on the geometry shown in the *GPE* (Appendix E), the existing pier footing may conflict with installation of some of the piles. The proposed pier pile locations should be selected to miss the existing footing.

4.3.5 Lateral Loading

Lateral loads on the piles should be analyzed for maximum moments and lateral deflections. Recommended lateral soil modulus and strain parameters required for analysis via the p-y curve method are included in Tables 6 to 9.

Table 6: Recommended Soil Parameters for Lateral Load Analysis at West Abutments
 Reference Borings 80/55-BSB-01, 80/55-BSB-04, and 80/55-BSB-07

Elevation Range (feet) Soil Type (Layer)	Unit Weight, γ (pcf)	Undrained Shear Strength, c_u (psf)	Estimated Friction Angle, Φ ($^\circ$)	Estimated Lateral Soil Modulus Parameter, k (pci)	Estimated Soil Strain Parameter, ϵ_{50} (%)
603.83 ⁽¹⁾ to 592.91 ⁽²⁾ New FILL (Bentonite)	120	1000	0	500	0.7
592.91 ⁽²⁾ to 589.0 Very Stiff to Hard CLAY LOAM and SILTY CLAY to SILTY CLAY LOAM FILL	120	2800	0	1000	0.5
589.0 to 579.0 Very Stiff to Hard CLAY to SILTY CLAY and SILTY CLAY LOAM	120	4000	0	1000	0.5
579.0 to 574.0 Dense to Very Dense GRAVEL to GRAVELLY LOAM	58 ⁽³⁾	0	34	125	--
574.0 to 572.0 ⁽⁴⁾ WEATHERED BEDROCK	58 ⁽³⁾	0	36	125	--

- (1) Pile cap base elevation
- (2) Approximate bottom of precoring elevation
- (3) Submerged unit weight
- (4) Approximate top of bedrock

Table 7: Recommended Soil Parameters for Lateral Load Analysis at Piers
 Reference Boring 80/55-BSB-02, 80/55-BSB-05, and 80/55-BSB-08

Elevation Range (feet) Soil Type (Layer)	Unit Weight, γ (pcf)	Undrained Shear Strength, c_u (psf)	Estimated Friction Angle, Φ ($^\circ$)	Estimated Lateral Soil Modulus Parameter, k (pci)	Estimated Soil Strain Parameter, ϵ_{50} (%)
581.0 ⁽¹⁾ to 580.0 Very Stiff to Hard SILTY CLAY FILL	120	3000	0	1000	0.5
580.0 to 577.0 Loose SANDY LOAM	48 ⁽²⁾	0	29	20	--
577.0 to 574.0 ⁽³⁾ Very Dense WEATHERED BEDROCK	58 ⁽²⁾	0	36	125	--

- (1) Existing grade elevations at proposed pier locations
- (2) Submerged unit weight
- (3) Approximate top of bedrock

Table 8: Recommended Soil Parameters for Lateral Load Analysis at East Abutments
 Reference Borings 80/55-BSB-03, 80/55-BSB-06, and 80/55-BSB-09

Elevation Range (feet) Soil Type (Layer)	Unit Weight, γ (pcf)	Undrained Shear Strength, c_u (psf)	Estimated Friction Angle, Φ ($^\circ$)	Estimated Lateral Soil Modulus Parameter, k (pci)	Estimated Soil Strain Parameter, ϵ_{50} (%)
601.06 ⁽¹⁾ to 590.3 ⁽²⁾ New FILL (Bentonite)	120	1000	0	500	0.7
590.0 to 586.0 Stiff to Hard CLAY LOAM to SILTY CLAY LOAM FILL	58 ⁽³⁾	3300	0	1000	0.5
586.0 to 577.0 Stiff to Hard SILTY CLAY to SILTY CLAY LOAM	58 ⁽³⁾	2500	0	1000	0.5
577.0 to 576.0 ⁽⁴⁾ WEATHERED BEDROCK	58 ⁽³⁾	0	36	125	--

(1) Pile cap base elevation

(2) Approximate bottom of precoring elevation

(3) Submerged unit weight

(4) Approximate top of bedrock

Table 9: Bedrock Parameters for Lateral Load Analysis
 Reference Borings 80/55-BSB-01 to 80/55-BSB-09

Bedrock	Total Unit Weight, γ (pcf)	Modulus of Rock Mass (ksi)	Uniaxial Compressive Strength (psi)	RQD (%)	Strain Factor
Dolostone	140	140	5,242 to 8,775	0 to 39	0.0005

4.4 Stage Construction

Stage construction is identified in the *GPE* (Appendix E). Wang understands that the bridge replacements will be performed utilizing two main stages of construction to maintain traffic on each bridge. During Stage I, two lanes of traffic would be moved to the outside lanes and shoulders of the existing bridges so that the widening can advance within the existing median area. During Stage II, the two lanes of traffic would utilize the roadway constructed during Stage I so that the existing bridges can be removed and the outside portion of the bridges can be replaced.

The construction activities will likely involve excavations of up to 9.0 feet along the sides of the existing east and west abutments, respectively. Temporary support systems will be required if the

ground cannot be sloped at 1:2 (V: H). We estimate temporary steel sheet piling, designed using the charts included in the *IDOT Design Guide-Simplified Temporary Sheet Piling Design Charts* is feasible at the abutments.

For the proposed full removal and replacement of the piers and/or the installation of spread footing supported on bedrock, temporary support of up to 14.0 feet of excavation will be required. Due to the presence of hard cohesive soils with Q_u values of greater than 4.5 tsf and shallow bedrock, we estimate the pier excavations may not be supported with cantilever steel sheet piling, and we recommend including the pay item, *Temporary Soil Retention System* for the shoring.

5.0 CONSTRUCTION CONSIDERATIONS

5.1 Site Preparation

Vegetation, surface topsoil, pavements, and debris should be cleared and stripped where the structures will be placed. If unstable or unsuitable materials are exposed during excavation, they should be removed and replaced with compacted structural fill as described in Section 5.3.

5.2 Excavation, Dewatering, and Utilities

Excavations should be performed in accordance with local, state, and federal regulations including current OSHA regulations. The potential effect of ground movements upon nearby utilities should be considered during construction. Any slope that cannot be graded at 1:2 (V: H) for cohesive soils and at 1:2.5 (V:H) for saturated granular soils should be properly shored.

We understand the temporary excavations for construction of the pier will be graded at a slope of 1:1.5 (V: H). The excavation slopes can be graded as per current OSHA guidelines. If the slope cannot be maintained, it should be properly shored. Excavated material should not be stockpiled immediately adjacent to the top of slopes, nor should equipment be allowed to operate too closely to open excavations.

During the subsurface investigation, the groundwater was encountered at elevations ranging from 580 to 575 feet, as discussed in Section 3.2. At the abutments, the groundwater will be about 18.0 to 15.0 feet below the proposed pile cap base elevations at the west and east abutments, respectively; therefore, we do not anticipate the need for dewatering. The pier excavation to bedrock will encounter groundwater and the Contractor should be prepared for dewatering. Additionally, perched or temporary water may be encountered during times of heavy precipitation while excavating within the

upper fill soils and will require dewatering efforts. Water that does accumulate in open excavations by seepage or runoff should be immediately removed by sump pump.

5.3 Filling and Backfilling

Fill material used to attain final design elevations should be pre-approved, cohesive or granular soil conforming to Section 204, *Borrow and Furnished Excavation* (IDOT 2022). The fill material should be free of organic matter and debris and should be placed in lifts and compacted according to Section 205, *Embankment* (IDOT 2022). In accordance with IDOT Section 205, *Embankment*, any embankments proposed for widening should be properly benched or deeply plowed prior to placement of new fill along the slopes (IDOT 2022).

Backfill materials for the abutments must be pre-approved by the Resident Engineer. To backfill the abutments, we recommend porous granular material conforming to the requirements specified in the IDOT Supplemental Special and Recurring Special Provisions, *Granular Backfill for Structures* (IDOT 2020b).

5.4 Earthwork Operations

The required earthwork can be accomplished with conventional construction equipment. Moisture and traffic will cause deterioration of exposed subgrade soils. Precautions should be taken by the Contractor to prevent water erosion of the exposed subgrade. A compacted subgrade will minimize water runoff erosion.

Earth moving operations should be scheduled to not coincide with excessive cold or wet weather (early spring, late fall or winter). Any soil allowed to freeze or soften due to the standing water should be removed. Wet weather can cause problems with subgrade compaction.

It is recommended that an experienced geotechnical engineer be retained to inspect the exposed subgrade, monitor earthwork operations, and provide material inspection services during the construction phase of this project.

5.5 Pile Installation

The driven and/or drilled piles shall be furnished and installed according to the requirements of IDOT Section 512, *Piling* (IDOT 2022). Wang recommends performing one test pile at each substructure location. Since hard driving is expected below an approximate elevation of 580 feet, pile shoes are required as indicated in Section 4.3.1.

5.6 Drilled Shafts

Drilled shafts should be installed as per Section 516, *Drilled Shafts* (IDOT 2022). Due to the presence of groundwater and the possible presence of granular soils above the bedrock, the recommended construction method for shafts socketed into bedrock is to install casing to the top of the rock to maintain clean, open shafts during excavation. Loss of water circulation was not noted while coring, however, cavities are known to be present in this area, as discussed in Section 1.1. The quality of bedrock at the proposed pier locations should be verified during construction.

6.0 QUALIFICATIONS

The analysis and recommendations submitted in this report are based upon the data obtained from the borings drilled at the locations shown on the boring logs and in Exhibit 3. This report does not reflect any variations that may occur between the borings or elsewhere on the site, variations whose nature and extent may not become evident until the course of construction. In the event that any changes in the design and/or location of the structure are planned, we should be timely informed so that our recommendations can be adjusted accordingly.

It has been a pleasure to assist Stantec and the Illinois Department of Transportation on this project. Please call if there are any questions, or if we can be of further service.

Respectfully Submitted,

WANG ENGINEERING, INC.

Azza Hamad, P.E.
Senior Geotechnical Engineer

Nesam Balakumaran, P.Eng.
Project Geotechnical Engineer

Corina Farez, P.E., P.G.
QC/QA Reviewer

REFERENCES

- AMERICAN ASSOCIATION OF STATE HIGHWAY TRANSPORTATION OFFICIALS (2020) "*AASHTO LRFD Bridge Design Specifications*" United States Department of Transportation, Washington, D.C.
- BAUER, R.A., CURRY, B.B., GRAESE, A.M., VAIDEN, R.C., SU, W.J., AND HASEK, M.J. (1991) "*Geotechnical Properties of Selected Pleistocene, Silurian, and Ordovician Deposits of Northeastern Illinois.*" Environmental Geology 139, Illinois State Geological Survey.
- HANSEL, A.K., and JOHNSON, W.H. (1996) "*Wedron and Mason Groups: Lithostratigraphic Reclassification of the Wisconsin Episode, Lake Michigan Lobe Area.*" ISGS Bulletin 104. Illinois State Geological Survey, Champaign 116 p.
- IDOT (2012) *Bridge Manual*. Illinois Department of Transportation.
- IDOT (2022) *Standard Specifications for Road and Bridge Construction*. Illinois Department of Transportation.
- IDOT (2019) *All Bridge Designers Memo 19.8*. Illinois Department of Transportation.
- IDOT (2020a) *Geotechnical Manual*. Illinois Department of Transportation.
- IDOT (2020b) *Supplemental Special and Recurring Special Provisions*. Illinois Department of Transportation.
- KOLATA, D.R. (2005) *Bedrock Geology of Illinois*: Illinois State Geological Survey, Illinois Map 14, 1:500,000.
- LEIGHTON, M.M., EKBLAW, G.E., and HORBERG, L. (1948) "*Physiographic Divisions of Illinois.*" The Journal of Geology, v. 56. p. 16-33.
- WILLMAN, H.B. (1971) *Surficial Deposits of Illinois*: Illinois State Geological Survey, ISGS, OFS 2000-7, 1:500,000.
- WOLLER, D.M. AND SANDERSON, E.W. (1983) Public groundwater supplies in Will county. Bulletin (Illinois State Water Survey) no. 60-29.

EXHIBITS



I-80 BRIDGE OVER I-55
 NW 1/4 of Section 27 & NE 1/4 of Section 28,
 T 35N, R 9E of 3rd PM

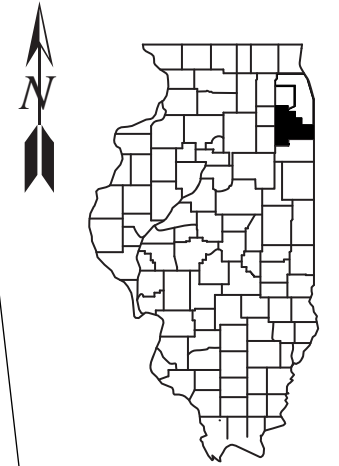

Will County

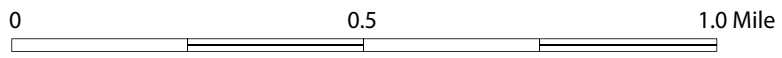

SITE LOCATION MAP: I-80 BRIDGE OVER I-55; I-80 RECONSTRUCTION FROM EAST OF RIDGE RD TO HOUBOLT RD; WILL COUNTY, ILLINOIS

SCALE: GRAPHICAL	EXHIBIT 1	DRAWN BY: J. Bensen CHECKED BY: A. Hamad
------------------	------------------	---

 Wang Engineering	1145 N. Main Street Lombard, IL 60148 www.wangeng.com
	FOR STANTEC

255-39-01

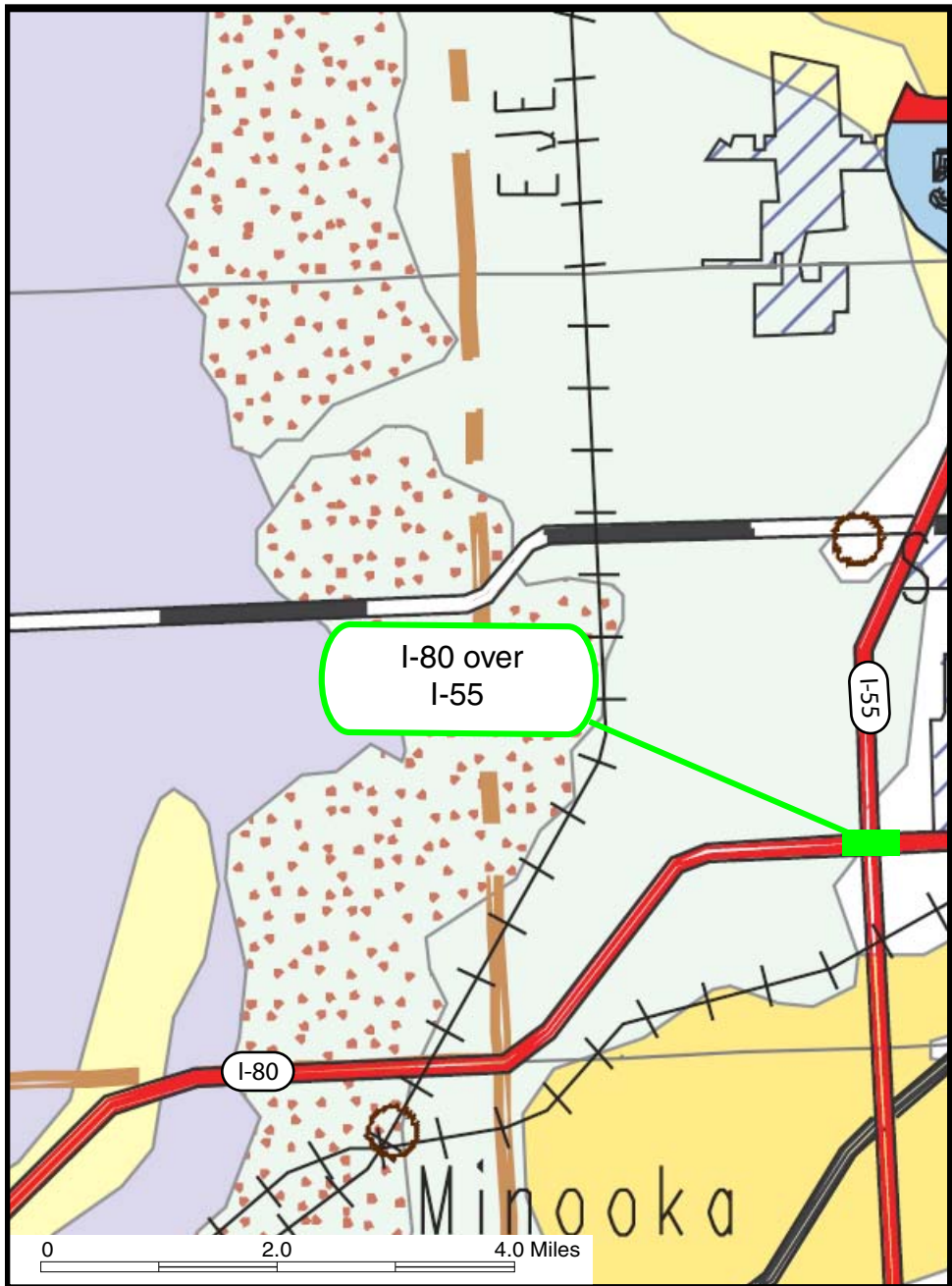

Modified after William W. Shiits (2000)

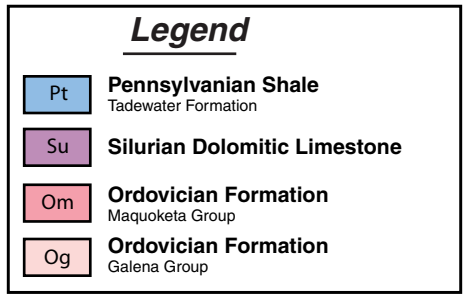
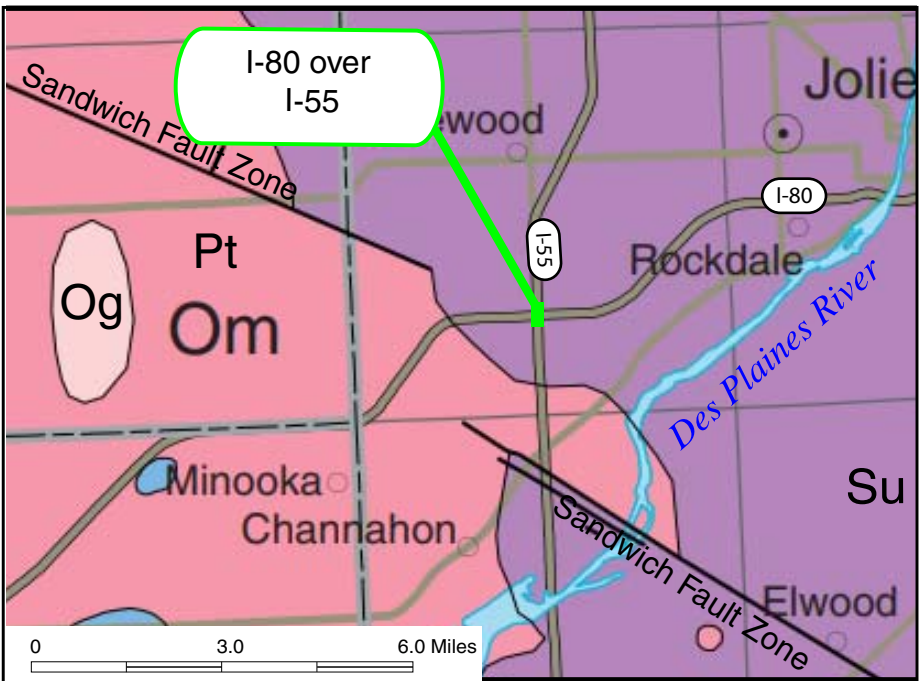
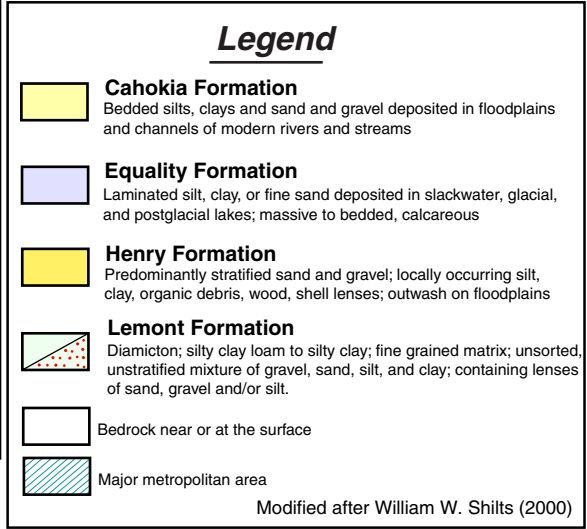
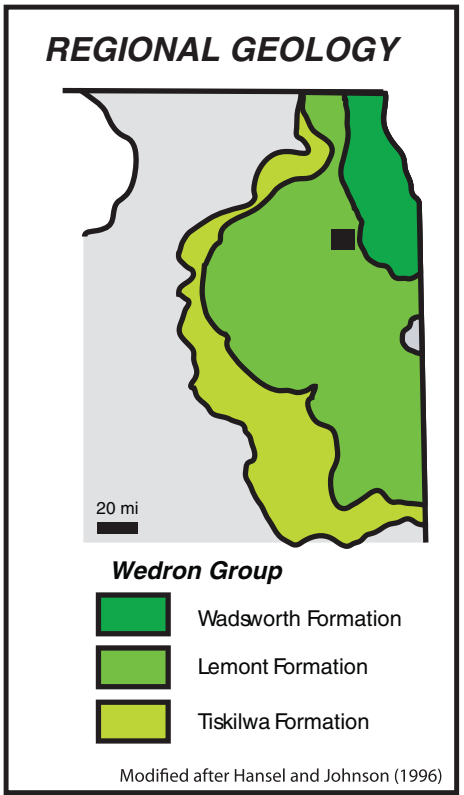

SITE AND REGIONAL GEOLOGY: I-80 RECONSTRUCTION, I-80 BRIDGE over I-55, WILL COUNTY, ILLINOIS

SCALE: GRAPHICAL	EXHIBIT 2	DRAWN BY: C. Marin CHECKED BY: L. Iordache
------------------	------------------	---

Wang Engineering
1145 N. Main Street
Lombard, IL 60148
www.wangeng.com

FOR STANTEC 255-39-01

Modified after Dennis R. Kolata (2005)

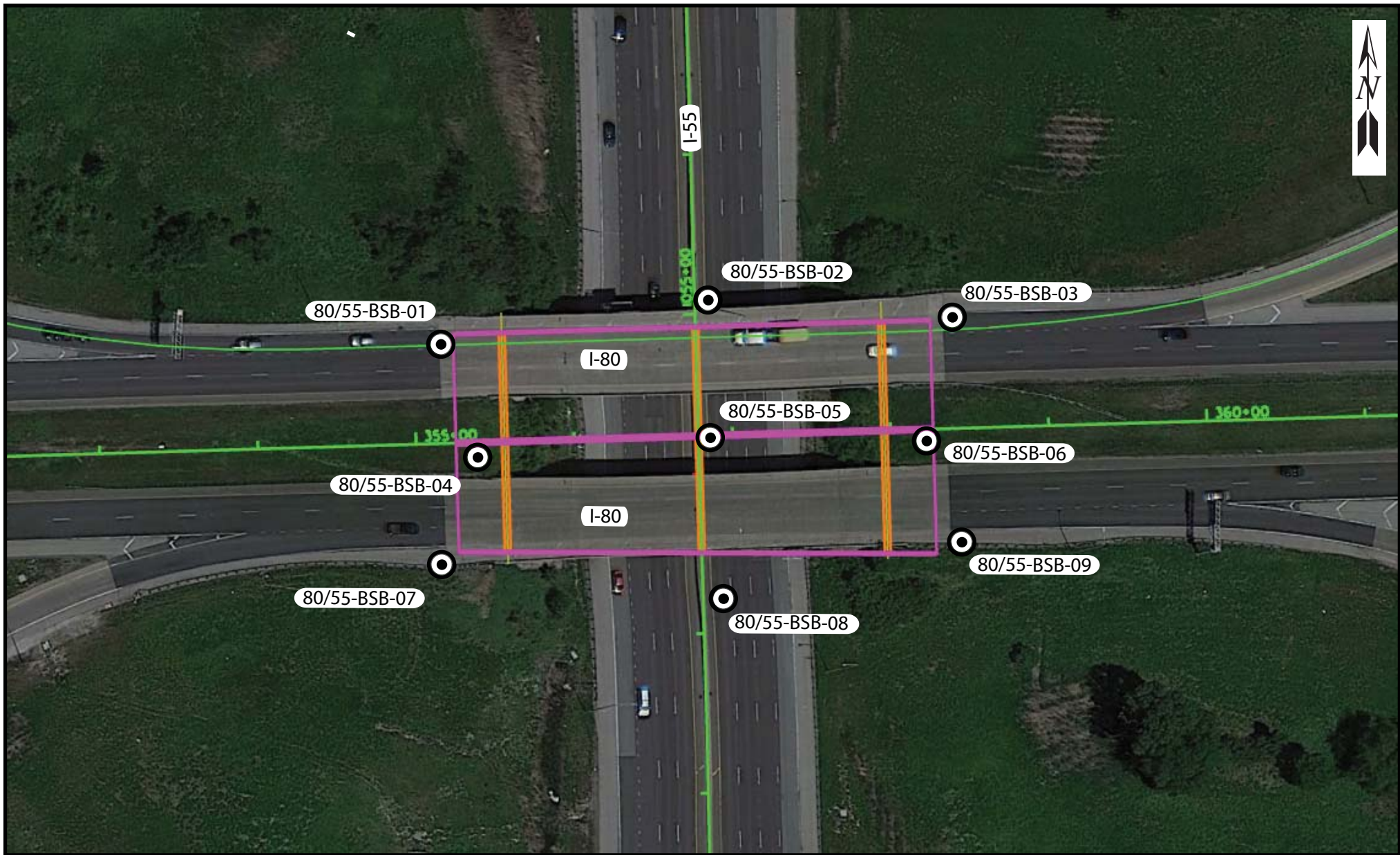

Legend

○ Boring Location

Scale

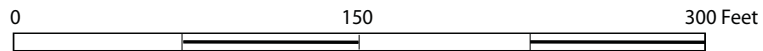

BORING LOCATION PLAN: I-80 BRIDGE OVER I-50, I-80 RECONSTRUCTION FROM EAST OF RIDGE ROAD TO HOUBOLT ROAD, WILL COUNTY, ILLINOIS

SCALE: GRAPHICAL

EXHIBIT 3

DRAWN BY: D. You
CHECKED BY: N. Balakumaran



1145 N. Main Street
Lombard, IL 60148
www.wangeng.com

FOR STANTEC

255-39-01

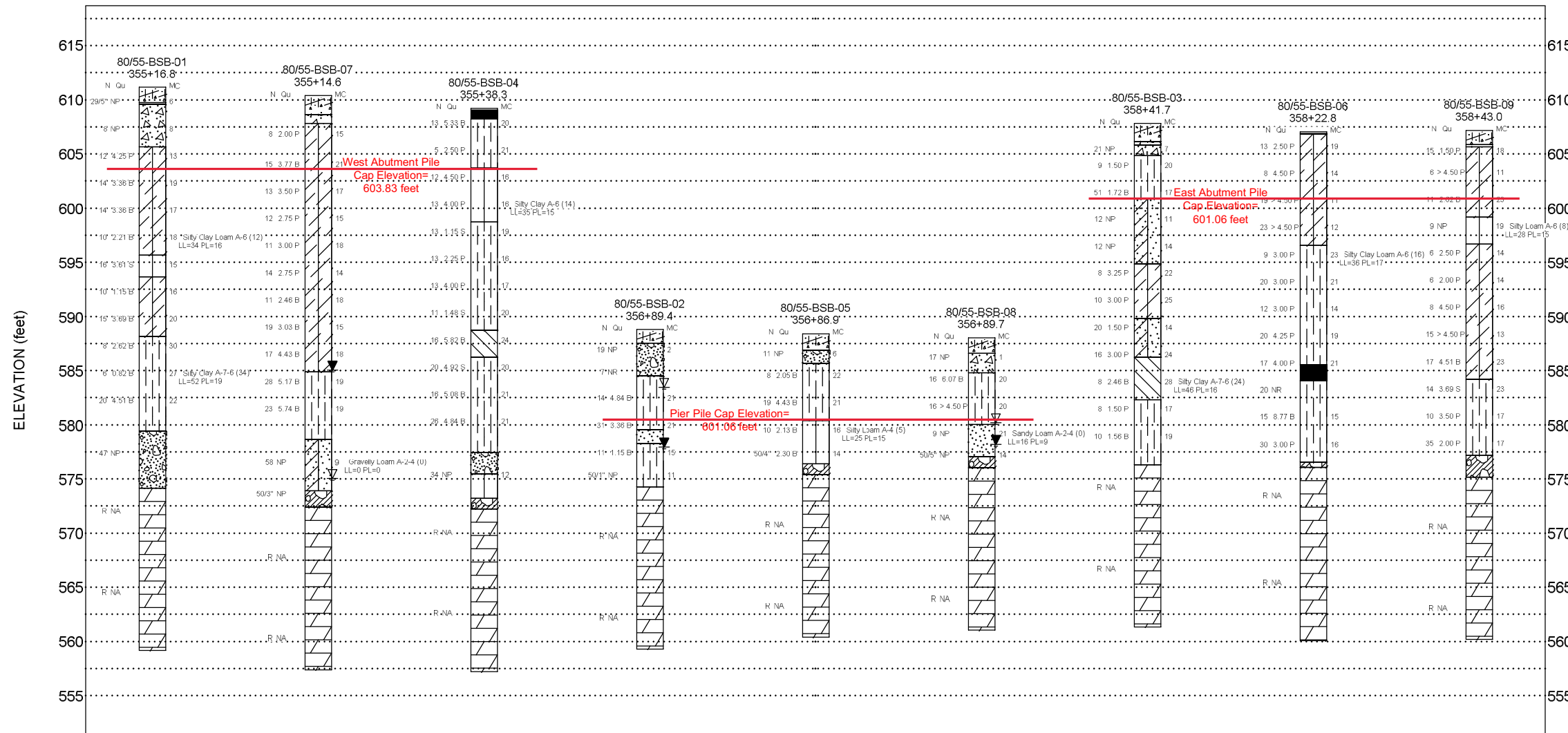

DISTANCE ALONG PROFILE (feet)

Lithology Graphics

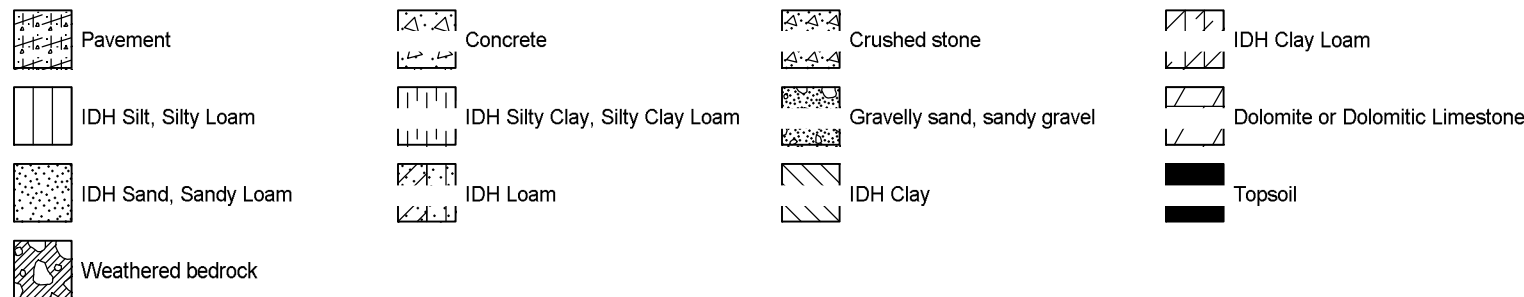

Site Map Scale 1 inch equals 130 feet

Explanation:

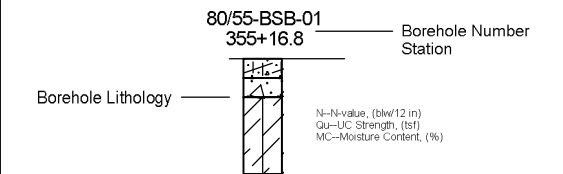

- Water Level Reading at time of drilling.
- Water Level Reading 24-hr after drilling or at end of drilling

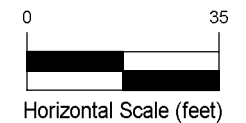

Vertical Exaggeration: 3x

Wang Engineering, Inc.
1145 N Main Street
Lombard, IL 60148

**Soil Profile
I-80 Over I-55 Bridges**



I-80 Reconstruction, Ridge Road to
Houbolt Road
Will County, Illinois

JOB NUMBER	PLATE NUMBER
255-39-01	EXHIBIT 4

APPENDIX A



wangeng@wangeng.com
 1145 N. Main Street
 Lombard/IL/60148
 Telephone: 6309539928
 Fax: 6309539938

BORING LOG 80/55-BSB-01

WEI Job No.: 255-39-01

Client **Stantec**
 Project **I-80 Reconstruction, Ridge Road to Houbolt Road**
 Location **Will County, Illinois**

Datum: NAVD 88
 Elevation: 611.15 ft
 North: 1755503.86 ft
 East: 1021318.23 ft
 Station: 355+16.8
 Offset: 62.5 LT

Profile	Elevation (ft)	SOIL AND ROCK DESCRIPTION	Depth (ft)	Sample Type recovery	Sample No.	SPT Values (blw/6 in)	Qu (tsf)	Moisture Content (%)	Profile	Elevation (ft)	SOIL AND ROCK DESCRIPTION	Depth (ft)	Sample Type recovery	Sample No.	SPT Values (blw/6 in)	Qu (tsf)	Moisture Content (%)
		17-inch thick ASPHALT --PAVEMENT--									--RDR 2--						
	609.7	2-inch thick CONCRETE --PAVEMENT--			1	29/5"	NP	6			--trace brick fragments--			9	5 6 9	3.69 B	20
	609.6	Loose to medium dense, gray Gravelly SAND; damp --AGGREGATE BASE--															
		--white COBBLE fragments--			2	3 3 5	NP	8						10	5 3 5	2.62 B	30
			5														
	605.7	Very stiff to hard, gray to brown SILTY CLAY LOAM to CLAY LOAM, trace gravel, trace brick fragments; damp			3	8 6 6	4.25 P	13						11	5 3 3	0.82 B	27
		--FILL-- --RDR 2--															
					4	7 8 6	3.36 B	19						12	6 9 11	4.51 B	22
		--trace brick fragments--			5	4 5 9	3.36 B	17									
					6	4 4 6	2.21 B	18						13	6 14 33	NP	
		--L _L (%)=34, P _L (%)=16-- --%Gravel=7.8-- --%Sand=15.6-- --%Silt=49.2-- --%Clay=27.4-- --A-6 (12)--			15												
	595.7	Medium dense, gray SILT, trace gravel; damp			7	7 9 7	3.61 S	15									
		--FILL-- --RDR 2--															
	593.7	Stiff to very stiff, brown and gray CLAY LOAM to SILTY CLAY LOAM, trace gravel, trace brick fragments; damp			8	3 4 6	1.15 B	16						14			
		--FILL--			20												

GENERAL NOTES

Begin Drilling **01-18-2022** Complete Drilling **01-18-2022**
 Drilling Contractor **Wang Testing Services** Drill Rig **20D50T [80%]**
 Driller **RH&MG** Logger **M. Rojo** Checked by **C. Marin**
 Drilling Method **2.25" ID HSA to 10 ft; mud rotary thereafter; boring...**
backfilled upon completion

WATER LEVEL DATA

While Drilling **DRY**
 At Completion of Drilling **mud at 0 feet**
 Time After Drilling **NA**
 Depth to Water **NA**

The stratification lines represent the approximate boundary between soil types; the actual transition may be gradual.

WANGENGINC 2553901.GPJ WANGENG.GDT 2/18/22



wangeng@wangeng.com
 1145 N. Main Street
 Lombard/IL/60148
 Telephone: 6309539928
 Fax: 6309539938

BORING LOG 80/55-BSB-01

WEI Job No.: 255-39-01

Client **Stantec**
 Project **I-80 Reconstruction, Ridge Road to Houbolt Road**
 Location **Will County, Illinois**

Datum: NAVD 88
 Elevation: 611.15 ft
 North: 1755503.86 ft
 East: 1021318.23 ft
 Station: 355+16.8
 Offset: 62.5 LT

Profile	Elevation (ft)	SOIL AND ROCK DESCRIPTION	Depth (ft)	Sample Type recovery	Sample No.	SPT Values (blw/6 in)	Qu (tsf)	Moisture Content (%)	Profile	Elevation (ft)	SOIL AND ROCK DESCRIPTION	Depth (ft)	Sample Type recovery	Sample No.	SPT Values (blw/6 in)	Qu (tsf)	Moisture Content (%)
		0.05-inch opening, soft joint wall, slicken joint wall surface, soft infill strength and less than 0.2-inch infill thickness. -- Run 1: 37.0 to 42.0 feet-- --Recovery = 91%-- --RQD = 18%-- --drilling rate, 2.1 min/ft-- -- Run 2: 42.0 to 52.0 feet-- --Recovery = 96%-- --RQD = 66%-- --drilling rate, 2.2 min/ft--	45														
			50														
	559.2	Boring terminated at 52.00 ft	55														
			60														

C
O
R
E

15

GENERAL NOTES

Begin Drilling **01-18-2022** Complete Drilling **01-18-2022**
 Drilling Contractor **Wang Testing Services** Drill Rig **20D50T [80%]**
 Driller **RH&MG** Logger **M. Rojo** Checked by **C. Marin**
 Drilling Method **2.25" ID HSA to 10 ft; mud rotary thereafter; boring... backfilled upon completion**

WATER LEVEL DATA

While Drilling ∇ **DRY**
 At Completion of Drilling ∇ **mud at 0 feet**
 Time After Drilling **NA**
 Depth to Water ∇ **NA**

The stratification lines represent the approximate boundary between soil types; the actual transition may be gradual.

WANGENGINC 2553901.GPJ WANGENG.CDT 2/18/22



BORING LOG 80/55-BSB-03

wangeng@wangeng.com
 1145 N. Main Street
 Lombard/IL/60148
 Telephone: 6309539928
 Fax: 6309539938

WEI Job No.: 255-39-01

Client **Stantec**
 Project **I-80 Reconstruction, Ridge Road to Houbolt Road**
 Location **Will County, Illinois**

Datum: NAVD 88
 Elevation: 607.82 ft
 North: 1755521.40 ft
 East: 1021642.76 ft
 Station: 358+41.7
 Offset: 70.1 LT

Profile	Elevation (ft)	SOIL AND ROCK DESCRIPTION	Depth (ft)	Sample Type recovery	Sample No.	SPT Values (blw/6 in)	Qu (tsf)	Moisture Content (%)	Profile	Elevation (ft)	SOIL AND ROCK DESCRIPTION	Depth (ft)	Sample Type recovery	Sample No.	SPT Values (blw/6 in)	Qu (tsf)	Moisture Content (%)	
		20-inch thick ASPHALT --PAVEMENT--																
	606.2									586.2								
	605.84	4-inch thick CONCRETE --PAVEMENT--									Very stiff, black, gray and brown CLAY to SILTY CLAY; damp --RDR 2--			9	7	3.00	24	
	604.8	Gray fine SAND, trace gravel; damp --AGGREGATE BASE--			1	3 12 9	NP	7										
		Stiff, brown and gray SILTY CLAY to SILTY CLAY LOAM, trace gravel; damp --FILL-- --RDR 2--	5		2	4 4 5	1.50 P	20			--L _L (%)=46, P _L (%)=16-- --%Gravel=0.5-- --%Sand=18.4-- --%Silt=50.8-- --A-7-6 (24)--			10	4 5 3	2.46 B	28	
	600.8	Medium dense, brown Gravelly SILTY LOAM to LOAM; moist to wet --FILL-- --RDR 2--			3	5 38 13	1.72 B	17		582.3	Stiff, brown and gray SILTY CLAY LOAM to SILTY LOAM, trace gravel; damp --RDR 2--			11	6 3 5	1.50 P	17	
		--cobble fragments--	10		4	10 6 6	NP	11						12	3 4 6	1.56 B	19	
	594.8	Stiff to very stiff, black, brown, and gray CLAY LOAM to SILTY CLAY LOAM, trace to little gravel; damp --FILL-- --RDR 2--			5	10 8 4	NP	14		576.3	Medium strong, light gray, very poor to poor rock mass quality, shaly DOLOSTONE, occasionally vuggy; few shale partings, bedded, slightly weathered rock and joints, closely spaced horizontal joints, with less than 0.05-inch opening, soft joint wall, slicken joint wall surface, soft infill strength and less than 0.2-inch infill thickness. -- Run 1: 31.5 to 36.5 feet-- --Recovery = 100%-- --RQD = 0%-- --drilling rate, 1.5 min/ft-- -- Run 2: 36.5 to 46.5 feet-- --Recovery = 95%-- --RQD = 39%-- --drilling rate, 2.1 min/ft--			13				
	589.8	Brown and gray LOAM, trace gravel; damp --FILL--			6	6 3 5	3.25 P	22										
					7	4 4 6	3.00 P	25										
					8	8 10 10	1.50 P	14										

GENERAL NOTES

WATER LEVEL DATA

Begin Drilling **01-18-2022** Complete Drilling **01-18-2022**
 Drilling Contractor **Wang Testing Services** Drill Rig **20D50T [80%]**
 Driller **RH&MG** Logger **M. Rojo** Checked by **C. Marin**
 Drilling Method **2.25" ID HSA to 10 ft; mud rotary thereafter; boring...**
backfilled upon completion

While Drilling **DRY**
 At Completion of Drilling **mud at 30 feet**
 Time After Drilling **NA**
 Depth to Water **NA**

The stratification lines represent the approximate boundary between soil types; the actual transition may be gradual.

WANGENGINC 2553901.GPJ WANGENG.GDT 2/18/22



wangeng@wangeng.com
 1145 N. Main Street
 Lombard/IL/60148
 Telephone: 6309539928
 Fax: 6309539938

BORING LOG 80/55-BSB-03

WEI Job No.: 255-39-01

Client **Stantec**
 Project **I-80 Reconstruction, Ridge Road to Houbolt Road**
 Location **Will County, Illinois**

Datum: NAVD 88
 Elevation: 607.82 ft
 North: 1755521.40 ft
 East: 1021642.76 ft
 Station: 358+41.7
 Offset: 70.1 LT

Profile	Elevation (ft)	SOIL AND ROCK DESCRIPTION	Depth (ft)	Sample Type <i>recovery</i>	Sample No.	SPT Values (blw/6 in)	Qu (tsf)	Moisture Content (%)	Profile	Elevation (ft)	SOIL AND ROCK DESCRIPTION	Depth (ft)	Sample Type <i>recovery</i>	Sample No.	SPT Values (blw/6 in)	Qu (tsf)	Moisture Content (%)
		-Q _u at 36.5 feet=7,804 psi -Q _u at 37.0 feet=9,193 psi			14												
	561.3	Boring terminated at 46.50 ft	45														
			50														
			55														
			60														

GENERAL NOTES

WATER LEVEL DATA

Begin Drilling **01-18-2022** Complete Drilling **01-18-2022**
 Drilling Contractor **Wang Testing Services** Drill Rig **20D50T [80%]**
 Driller **RH&MG** Logger **M. Rojo** Checked by **C. Marin**
 Drilling Method **2.25" ID HSA to 10 ft; mud rotary thereafter; boring...
 backfilled upon completion**

While Drilling ∇ **DRY**
 At Completion of Drilling ∇ **mud at 30 feet**
 Time After Drilling **NA**
 Depth to Water ∇ **NA**

The stratification lines represent the approximate boundary between soil types; the actual transition may be gradual.



BORING LOG 80/55-BSB-04

wangeng@wangeng.com
 1145 N. Main Street
 Lombard/IL/60148
 Telephone: 6309539928
 Fax: 6309539938

WEI Job No.: 255-39-01

Client **Stantec**
 Project **I-80 Reconstruction, Ridge Road to Houbolt Road**
 Location **Will County, Illinois**

Datum: NAVD 88
 Elevation: 609.21 ft
 North: 1755434.41 ft
 East: 1021342.10 ft
 Station: 355+38.3
 Offset: 8.0 RT

Profile	Elevation (ft)	SOIL AND ROCK DESCRIPTION	Depth (ft)	Sample Type recovery	Sample No.	SPT Values (blw/6 in)	Qu (tsf)	Moisture Content (%)	Profile	Elevation (ft)	SOIL AND ROCK DESCRIPTION	Depth (ft)	Sample Type recovery	Sample No.	SPT Values (blw/6 in)	Qu (tsf)	Moisture Content (%)
	608.2	12-inch thick, brown SILTY CLAY LOAM --TOPSOIL-- Very stiff to hard, brown SILTY CLAY to SILTY CLAY LOAM, trace gravel; damp --FILL-- --RDR 2--	0-5	X	1	3 5 8	5.33 B	20		588.7	Hard, black and gray SILTY CLAY, trace organic matter --RDR 2--	0-10	X	9	6 6 10	5.82 B	24
	603.7	Hard, brown and gray SILTY CLAY LOAM to SILTY LOAM, trace gravel; damp --FILL-- --RDR 2-- --L _L (%)=35, P _L (%)=15-- --%Gravel=6.8-- --%Sand=13.4-- --%Silt=51.2-- --%Clay=28.6-- --A-6 (14)--	5-10	X	2	2 2 3	2.50 P	21		586.2	Hard, brown and gray SILTY CLAY to SILTY CLAY LOAM, trace gravel; damp --RDR 2--	10-25	X	10	5 8 12	4.92 S	20
	598.7	Stiff to hard, brow and gray SILTY CLAY to SILTY CLAY LOAM, trace gravel; damp --FILL-- --RDR 2--	10-15	X	3	5 6 6	4.50 P	16					X	11	8 5 11	5.08 B	21
			15-20	X	4	5 6 7	4.00 P	16				30	X	12	7 7 19	4.84 B	21
				X	5	3 3 10	1.15 S	19		577.5	Gray GRAVEL; damp --RDR 2-3--		X				
				X	6	6 7 6	2.25 P	16		575.5	Dense, gray SILT, trace gravel; damp --RDR 3-4-35		X	13	16 12 22	NP	12
				X	7	6 5 8	4.00 P	17		573.2	--Weathered BEDROCK--						
				X	8	3 4 7	1.48 S	20		572.2	Strong, dark grayish gray, very poor to fair rock mass quality, shaly DOLOSTONE, occasionally vuggy; few shale partings, bedded, closely spaced, slightly weathered, horizontal joints, with <0.05 inch opening, slicken walls,			14			

GENERAL NOTES

Begin Drilling **01-13-2022** Complete Drilling **01-16-2022**
 Drilling Contractor **Wang Testing Services** Drill Rig **21GeoT[92%]**
 Driller **JS&AP** Logger **M. Rojo** Checked by **C. Marin**
 Drilling Method **2.25" ID HSA to 10 ft; mud rotary thereafter; boring... backfilled upon completion**

WATER LEVEL DATA

While Drilling **DRY**
 At Completion of Drilling **mud at 30 feet**
 Time After Drilling **NA**
 Depth to Water **NA**

The stratification lines represent the approximate boundary between soil types; the actual transition may be gradual.

WANGENGINC 2553901.GPJ WANGENG.GDT 2/18/22



wangeng@wangeng.com
 1145 N. Main Street
 Lombard/IL/60148
 Telephone: 6309539928
 Fax: 6309539938

BORING LOG 80/55-BSB-06

WEI Job No.: 255-39-01

Client **Stantec**
 Project **I-80 Reconstruction, Ridge Road to Houbolt Road**
 Location **Will County, Illinois**

Datum: NGVD
 Elevation: 607.05 ft
 North: 1755444.34 ft
 East: 1021626.17 ft
 Station: 358+22.8
 Offset: 6.5 RT

Profile	Elevation (ft)	SOIL AND ROCK DESCRIPTION	Depth (ft)	Sample Type recovery	Sample No.	SPT Values (blw/6 in)	Qu (tsf)	Moisture Content (%)	Profile	Elevation (ft)	SOIL AND ROCK DESCRIPTION	Depth (ft)	Sample Type recovery	Sample No.	SPT Values (blw/6 in)	Qu (tsf)	Moisture Content (%)	
	606.92	2-inch thick, dark brown SILTY CLAY --TOPSOIL-- Very stiff to hard, brown and gray CLAY LOAM to LOAM, trace gravel; damp			1	11 5 8	2.50 P	19		585.6	Hard, dark gray and black SILTY CLAY LOAM, trace organic matter; damp			9	7 8 9	4.00 P	21	
		--FILL-- --RDR 2--			2	2 3 5	4.50 P	14		584.1	--Buried TOPSOIL-- --RDR 2-- Very stiff to hard, brown SILTY CLAY to SILTY CLAY LOAM, trace gravel; damp			10	7 8 12	NR		
					3	10 10 9	4.50 P	11						11	7 7 8	8.77 B	15	
					4	4 12 11	4.50 P	12						12	5 16 14	3.00 P	16	
	596.6	Very stiff to hard, brown and gray SILTY CLAY LOAM to SILTY LOAM, trace gravel; damp --FILL-- --RDR 2-- --L _L (%)=36, P _L (%)=17-- --%Gravel=3.1-- --%Sand=9.5-- --%Silt=67.4-- --%Clay=19.9-- --A-6 (16)--			5	4 4 5	3.00 P	23		576.6	--rig chatter-- --weathered bedrock--			13				
					6	5 6 14	3.00 P	21		576.1	Strong, light grayish gray, very poor to poor quality, shaly DOLOSTONE, occasionally vuggy, few shale partings, bedded, closely spaced, slightly weathered, horizontal and vertical JOINTS, with <0.05 inch opening, slicken walls, and <0.2 inch thick clay infill. --RUN 1: 31.0 to 37.0 feet-- --Recovery: 90%-- --RQD: 6%--							
					7	3 7 5	3.00 P	14										
					8	7 8 12	4.25 P	19										

GENERAL NOTES

Begin Drilling **01-16-2022** Complete Drilling **01-16-2022**
 Drilling Contractor **Wang Testing Services** Drill Rig **20D50T [80%]**
 Driller **RH&MG** Logger **M. Rojo** Checked by **C. Marin**
 Drilling Method **2.25" ID HSA to 10 ft; mud rotary thereafter; boring... backfilled upon completion**

WATER LEVEL DATA

While Drilling **DRY**
 At Completion of Drilling **mud at 35 feet**
 Time After Drilling **NA**
 Depth to Water **NA**

The stratification lines represent the approximate boundary between soil types; the actual transition may be gradual.

WANGENGINC_2553901.GPJ WANGENG.GDT 2/18/22



wangeng@wangeng.com
 1145 N. Main Street
 Lombard/IL/60148
 Telephone: 6309539928
 Fax: 6309539938

BORING LOG 80/55-BSB-06

WEI Job No.: 255-39-01

Client **Stantec**
 Project **I-80 Reconstruction, Ridge Road to Houbold Road**
 Location **Will County, Illinois**

Datum: NGVD
 Elevation: 607.05 ft
 North: 1755444.34 ft
 East: 1021626.17 ft
 Station: 358+22.8
 Offset: 6.5 RT

Profile	Elevation (ft)	SOIL AND ROCK DESCRIPTION	Depth (ft)	Sample Type recovery	Sample No.	SPT Values (blw/6 in)	Qu (tsf)	Moisture Content (%)	Profile	Elevation (ft)	SOIL AND ROCK DESCRIPTION	Depth (ft)	Sample Type recovery	Sample No.	SPT Values (blw/6 in)	Qu (tsf)	Moisture Content (%)
	560.1	Boring terminated at 47.00 ft	45		14												

GENERAL NOTES

Begin Drilling **01-16-2022** Complete Drilling **01-16-2022**
 Drilling Contractor **Wang Testing Services** Drill Rig **20D50T [80%]**
 Driller **RH&MG** Logger **M. Rojo** Checked by **C. Marin**
 Drilling Method **2.25" ID HSA to 10 ft; mud rotary thereafter; boring... backfilled upon completion**

WATER LEVEL DATA

While Drilling ∇ **DRY**
 At Completion of Drilling ∇ **mud at 35 feet**
 Time After Drilling **NA**
 Depth to Water ∇ **NA**

The stratification lines represent the approximate boundary between soil types; the actual transition may be gradual.

WANGENGINC 2553901.GPJ WANGENG.GDT 2/18/22



BORING LOG 80/55-BSB-07

wangeng@wangeng.com
 1145 N. Main Street
 Lombard/IL/60148
 Telephone: 6309539928
 Fax: 6309539938

WEI Job No.: 255-39-01

Client **Stantec**
 Project **I-80 Reconstruction, Ridge Road to Houbolt Road**
 Location **Will County, Illinois**

Datum: NAVD 88
 Elevation: 610.38 ft
 North: 1755366.35 ft
 East: 1021320.22 ft
 Station: 355+14.6
 Offset: 75.0 RT

Profile	Elevation (ft)	SOIL AND ROCK DESCRIPTION	Depth (ft)	Sample Type recovery	Sample No.	SPT Values (blw/6 in)	Qu (tsf)	Moisture Content (%)	Profile	Elevation (ft)	SOIL AND ROCK DESCRIPTION	Depth (ft)	Sample Type recovery	Sample No.	SPT Values (blw/6 in)	Qu (tsf)	Moisture Content (%)
	608.6	21-inch thick ASPHALT --PAVEMENT--															
	607.8	10-inch thick CONCRETE --PAVEMENT--															
		Stiff to hard, brown, black and gray SILTY CLAY LOAM to CLAY LOAM, trace gravel; damp --FILL-- --RDR 2--	5		1	3 5 3 4	2.00 P	15		584.9		25		8 9	3.03 B	15	
					2	3 6 9	3.77 B	21			Hard, brown and gray SILTY CLAY, trace gravel; damp --RDR 2--			10	8 12 16	5.17 B	19
			10		3	4 5 8	3.50 P	17				30		11	5 13 10	5.74 B	19
					4	4 5 7	2.75 P	15		578.6	Very dense, gray Gravelly LOAM; damp --RDR 2-4-- --L _L (%)=NP, P _L (%)=NP-- --%Gravel=43.0-- --%Sand=27.9-- --%Silt=27.0-- --%Clay=2.1--35 --A-2-4 (0)--			12	12 28 30	NP	9
			15		5	2 4 7	3.00 P	18						13			
					6	5 5 9	2.75 P	14		573.9	--hard slow drilling--			13			NP
					7	4 4 7	2.46 B	18		572.4	Very dense SHALE FRAGMENTS --auger refusal at 38 feet--						
			20								Medium strong, dark grayish gray, very poor to good quality, shaly DOLOSTONE, occasionally						

GENERAL NOTES

Begin Drilling **01-03-2022** Complete Drilling **01-03-2022**
 Drilling Contractor **Wang Testing Services** Drill Rig **17B57T [91%]**
 Driller **N&K** Logger **F. Bozga** Checked by **C. Marin**
 Drilling Method **3.25" ID HSA; boring backfilled upon completion**

WATER LEVEL DATA

While Drilling **35.50 ft**
 At Completion of Drilling **core wash 28ft**
 Time After Drilling **180 hours**
 Depth to Water **25.50 ft**

The stratification lines represent the approximate boundary between soil types; the actual transition may be gradual.

WANGENGINC 2553901.GPJ WANGENG.GDT 2/18/22



wangeng@wangeng.com
 1145 N. Main Street
 Lombard/IL/60148
 Telephone: 6309539928
 Fax: 6309539938

BORING LOG 80/55-BSB-07

WEI Job No.: 255-39-01

Client **Stantec**
 Project **I-80 Reconstruction, Ridge Road to Houbolt Road**
 Location **Will County, Illinois**

Datum: NAVD 88
 Elevation: 610.38 ft
 North: 1755366.35 ft
 East: 1021320.22 ft
 Station: 355+14.6
 Offset: 75.0 RT

Profile	Elevation (ft)	SOIL AND ROCK DESCRIPTION	Depth (ft)	Sample Type recovery	Sample No.	SPT Values (blw/6 in)	Qu (tsf)	Moisture Content (%)	Profile	Elevation (ft)	SOIL AND ROCK DESCRIPTION	Depth (ft)	Sample Type recovery	Sample No.	SPT Values (blw/6 in)	Qu (tsf)	Moisture Content (%)
		vuggy; few shale partings, bedded, interbedded mudstone, closely spaced, slightly weathered to fresh, horizontal JOINTS, with 0-0.2 inch opening, slicken to slightly rough walls, and 0 - 0.2 inch thick clay infill. --RUN 1: 38.0 to 48.0 feet-- --Recovery: 98%-- --RQD: 18%-- --Q _u at 44.0 feet=5,242 psi	45		14												
		--RUN 2: 48.0 to 53.0 feet-- --Recovery: 100%-- --RQD: 87%--	50		15				C O R E								
	557.4	Boring terminated at 53.00 ft	55														
			60														

GENERAL NOTES

WATER LEVEL DATA

Begin Drilling **01-03-2022** Complete Drilling **01-03-2022**
 Drilling Contractor **Wang Testing Services** Drill Rig **17B57T [91%]**
 Driller **N&K** Logger **F. Bozga** Checked by **C. Marin**
 Drilling Method **3.25" ID HSA; boring backfilled upon completion**

While Drilling ∇ **35.50 ft**
 At Completion of Drilling \blacktriangledown **core wash 28ft**
 Time After Drilling **180 hours**
 Depth to Water ∇ **25.50 ft**

The stratification lines represent the approximate boundary between soil types; the actual transition may be gradual.

WANGENGINC 2553901.GPJ WANGENG.CDT 2/18/22



wangeng@wangeng.com
 1145 N. Main Street
 Lombard/IL/60148
 Telephone: 6309539928
 Fax: 6309539938

BORING LOG 80/55-BSB-09

WEI Job No.: 255-39-01

Client **Stantec**
 Project **I-80 Reconstruction, Ridge Road to Houbolt Road**
 Location **Will County, Illinois**

Datum: NAVD 88
 Elevation: 607.17 ft
 North: 1755379.63 ft
 East: 1021648.43 ft
 Station: 358+43.0
 Offset: 71.8 RT

Profile	Elevation (ft)	SOIL AND ROCK DESCRIPTION	Depth (ft)	Sample Type recovery	Sample No.	SPT Values (blw/6 in)	Qu (tsf)	Moisture Content (%)	Profile	Elevation (ft)	SOIL AND ROCK DESCRIPTION	Depth (ft)	Sample Type recovery	Sample No.	SPT Values (blw/6 in)	Qu (tsf)	Moisture Content (%)
	605.8	16-inch thick ASPHALT --PAVEMENT--									--rig chatter; possible cobbles--						
	605.72	2-inch thick CONCRETE --PAVEMENT--															
		Stiff to hard, brown and gray SILTY CLAY LOAM to CLAY LOAM, trace gravel; damp --FILL-- --RDR 2--	5		1	4 8 7	1.50 P	18		584.2	Very stiff, brown and gray SILTY CLAY to SILTY CLAY LOAM, trace gravel; damp --RDR 2--	25		9	5 8 9	4.51 B	23
			5		2	3 2 4	4.50 P	11						10	5 6 8	3.69 S	23
					3	3 3 8	2.62 B	23						11	3 5 5	3.50 P	17
	599.2	Loose, brown SILTY LOAM, trace gravel; damp --FILL-- --RDR 2-- --L _L (%)=28, P _L (%)=15--	10		4	5 4 5	NP	19						12	5 5 30	2.00 P	17
	596.7	--%Gravel=5.3-- --%Sand=18.4-- --%Silt=64.3-- --%Clay=12.0-- --A-6 (8)--			5	3 3 3	2.50 P	14		577.2	--hard slow drilling at 30 feet-- --Weathered BEDROCK--	30					
		Very stiff to hard, brown and gray SILTY CLAY LOAM to CLAY LOAM, trace to little gravel; damp --FILL-- --RDR 2-3--	15		6	3 2 4	2.00 P	14		575.2	Strong, light grayish gray, poor to excellent quality, shaly DOLOSTONE, occasionally vuggy; few shale partings, bedded, closely spaced to massive, moderately to slightly weathered, horizontal and vertical JOINTS, with 0-0.2 inch opening, slicken walls, and <0.2 inch thick clay infill. --RUN 1: 32.0 to 42.0 feet-- --Recovery: 91%-- --RQD: 32%--	35					
					7	4 3 5	4.50 P	16						13			
			20		8	10 7 8	4.50 P	13				40					

GENERAL NOTES

Begin Drilling **01-11-2022** Complete Drilling **01-11-2022**
 Drilling Contractor **Wang Testing Services** Drill Rig **17B57T [91%]**
 Driller **JS&AP** Logger **M. Rojo** Checked by **C. Marin**
 Drilling Method **3.25" ID HSA; boring backfilled upon completion**

WATER LEVEL DATA

While Drilling **DRY**
 At Completion of Drilling **DRY**
 Time After Drilling **NA**
 Depth to Water **NA**

The stratification lines represent the approximate boundary between soil types; the actual transition may be gradual.

WANGENGINC 2553901.GPJ WANGENG.GDT 2/18/22



wangeng@wangeng.com
 1145 N. Main Street
 Lombard/IL/60148
 Telephone: 6309539928
 Fax: 6309539938

BORING LOG 80/55-BSB-09

WEI Job No.: 255-39-01

Client **Stantec**
 Project **I-80 Reconstruction, Ridge Road to Houbolt Road**
 Location **Will County, Illinois**

Datum: NAVD 88
 Elevation: 607.17 ft
 North: 1755379.63 ft
 East: 1021648.43 ft
 Station: 358+43.0
 Offset: 71.8 RT

Profile	Elevation (ft)	SOIL AND ROCK DESCRIPTION	Depth (ft)	Sample Type <i>recovery</i>	Sample No.	SPT Values (blw/6 in)	Qu (tsf)	Moisture Content (%)	Profile	Elevation (ft)	SOIL AND ROCK DESCRIPTION	Depth (ft)	Sample Type <i>recovery</i>	Sample No.	SPT Values (blw/6 in)	Qu (tsf)	Moisture Content (%)
	560.2																
		--RUN 2: 42.0 to 47.0 feet-- --Recovery: 93%-- --RQD: 93%--	45		14												
		Boring terminated at 47.00 ft															
			50														
			55														
			60														

C
O
R
E

GENERAL NOTES

WATER LEVEL DATA

Begin Drilling **01-11-2022** Complete Drilling **01-11-2022**
 Drilling Contractor **Wang Testing Services** Drill Rig **17B57T [91%]**
 Driller **JS&AP** Logger **M. Rojo** Checked by **C. Marin**
 Drilling Method **3.25" ID HSA; boring backfilled upon completion**

While Drilling ∇ **DRY**
 At Completion of Drilling ∇ **DRY**
 Time After Drilling **NA**
 Depth to Water ∇ **NA**

The stratification lines represent the approximate boundary between soil types; the actual transition may be gradual.

APPENDIX B

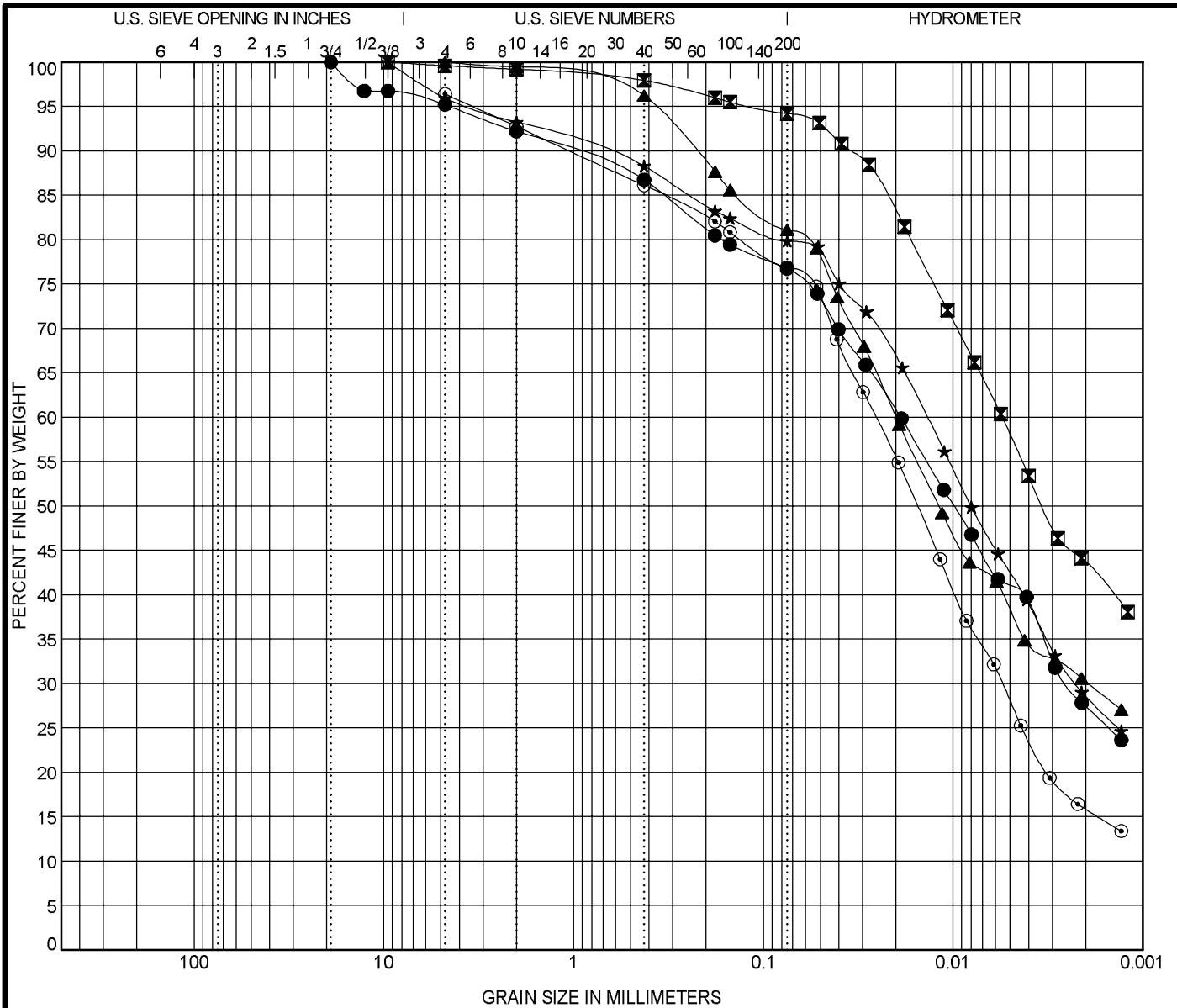

COBBLES	GRAVEL	SAND		SILT AND CLAY
		coarse	fine	

Specimen Identification		IDH Classification					LL	PL	PI	Cc	Cu
●	80/55-BSB-01#6 13.5 ft	Silty Clay Loam					34	16	18		
☒	80/55-BSB-01#11 26.0 ft	Silty Clay					52	19	33		
▲	80/55-BSB-03#10 23.5 ft	Silty Clay					46	16	30		
★	80/55-BSB-04#4 8.5 ft	Silty Clay					35	15	20		
◎	80/55-BSB-05#4 8.5 ft	Silty Loam					25	15	10		
Specimen Identification		D100	D60	D30	D10	%Gravel	%Sand	%Silt	%Clay		
●	80/55-BSB-01#6 13.5 ft	19	0.019	0.003		7.8	15.6	49.2	27.4		
☒	80/55-BSB-01#11 26.0 ft	9.5	0.006			0.8	5.0	50.6	43.6		
▲	80/55-BSB-03#10 23.5 ft	4.75	0.02	0.002		0.5	18.4	50.8	30.2		
★	80/55-BSB-04#4 8.5 ft	9.5	0.014	0.002		6.8	13.4	51.2	28.6		
◎	80/55-BSB-05#4 8.5 ft	4.75	0.026	0.006		7.2	16.0	60.9	15.9		



Wang Engineering, Inc.
 1145 N. Main Street
 Lombard/IL/60148
 Telephone: 6309539928
 Fax: 6309539938

GRAIN SIZE DISTRIBUTION
 Project: I-80 Reconstruction, Ridge Road to Houbolt Road
 Location: Will County, Illinois
 Number: 255-39-01

WEI GRAIN SIZE IDH 2553901.GPJ US LAB.GDT 2/18/22



Unconfined Compressive Strength of Intact Rock Core Specimens

Project: I-80 Reconstruction

Client: Stantec

WEI Job No.: 255-39-01

Field Sample ID	Run #	Depth (ft)	Location	Sample Description	Length (in)		Diameter (in)	Total Load (lbs)	Total Pressure (psi)	Fracture Type*	Break Date	Tested By	Area (in ²)
					Before Capping	After Capping							
80/55-BSB-02	1	23.5	WB Bridge Pier	Dolostone	3.92	NA	2.05	28040	8479	3	2/3/22	KJ	3.31
80/55-BSB-03	2	36.5	WB Bridge East Abutment	Dolostone	4.15	NA	2.06	26010	7804	3	1/25/22	MAC	3.33
80/55-BSB-03	2	37.0	WB Bridge East Abutment	Dolostone	4.19	NA	2.06	30640	9193	3	1/25/22	MAC	3.33
80/55-BSB-07	1	44.0	EB Bridge East Abutment	Dolostone	4.00	NA	2.06	17540	5242	3	1/5/22	MAC	3.34
80/55-BSB-08	1	21.5	EB Bridge Pier	Dolostone	3.90	NA	2.05	30170	8775	3	2/3/22	KJ	3.30

* Fracture Types:

- Type 1 - Reasonably well-formed cones on both ends, less than 1 in. [25 mm] of cracking through caps;
- Type 2 - Well-formed cone on one end, vertical cracks running through caps, no well defined cone on other end;
- Type 3 - Columnar, vertical cracking through both ends, no well-formed cones;
- Type 4 - Diagonal fracture with no cracking through ends, tap with hammer to distinguish from Type 1;
- Type 5 - Side fractures at top or bottom (occur commonly with unbonded caps);
- Type 6 - Similar to Type 5 but end of cylinder is pointed.

Prepared by:  2-17-2022

Checked by:  02/14/2022

APPENDIX C

Run #1



TOP

BOTTOM

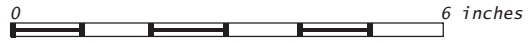

Boring: 80/55-BSB-01
Run #1, 37.0 to 42.0 feet, RECOVERY = 91%, RQD = 18%

BEDROCK CORE: I-80 BRIDGE OVER I-55; I-80 RECONSTRUCTION FROM EAST OF RIDGE RD TO HOUBOLT RD, WILL COUNTY, ILLINOIS		
SCALE: GRAPHICAL	APPENDIX C-1	DRAWN BY: E. Greenwood CHECKED BY: A. Hamad
		1145 N. Main Street Lombard, IL 60148 www.wangeng.com
FOR STANTEC		255-39-01

Run #2



0 6 inches

Boring: 80/55-BSB-01
Run #2, 42.0 to 52.0 feet, RECOVERY = 96%, RQD = 66%

BEDROCK CORE: I-80 BRIDGE OVER I-55; I-80 RECONSTRUCTION FROM EAST OF RIDGE RD TO HOUBOLT RD, WILL COUNTY, ILLINOIS

SCALE: GRAPHICAL

APPENDIX C-2

DRAWN BY: E. Greenwood
CHECKED BY: A. Hamad



1145 N. Main Street
Lombard, IL 60148
www.wangeng.com

FOR STANTEC

255-39-01

Run #1

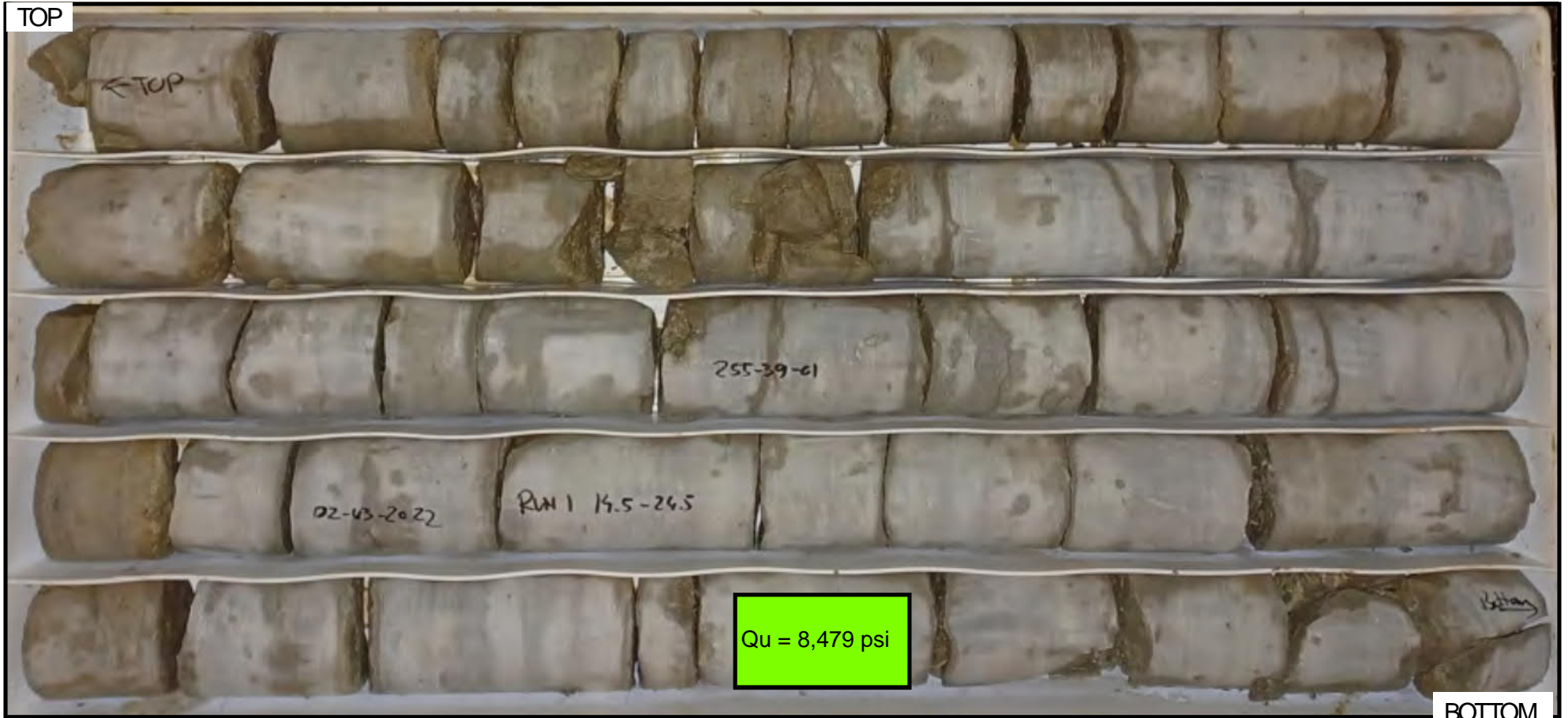

0 6 inches

Boring: 80/55-BSB-02
Run #1, 14.5 to 24.5 feet, RECOVERY = 100%, RQD = 18%

BEDROCK CORE: I-80 BRIDGE OVER I-55; I-80 RECONSTRUCTION FROM EAST OF RIDGE RD TO HOUBOLT RD, WILL COUNTY, ILLINOIS

SCALE: GRAPHICAL

APPENDIX C-3

DRAWN BY: E. Greenwood
CHECKED BY: A. Hamad



1145 N. Main Street
Lombard, IL 60148
www.wangeng.com

FOR STANTEC

255-39-01

Run #2

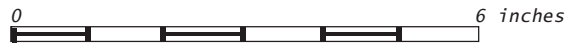

Boring: 80/55-BSB-02
Run #2, 24.5 to 29.5 feet, RECOVERY = 100%, RQD = 63%

BEDROCK CORE: I-80 BRIDGE OVER I-55; I-80 RECONSTRUCTION FROM EAST OF RIDGE RD TO HOUBOLT RD, WILL COUNTY, ILLINOIS

SCALE: GRAPHICAL

APPENDIX C-4

DRAWN BY: E. Greenwood
CHECKED BY: A. Hamad



1145 N. Main Street
Lombard, IL 60148
www.wangeng.com

FOR STANTEC

255-39-01

Run #1

TOP



BOTTOM

0 6 inches

Boring: 80/55-BSB-03
Run #1, 31.5 to 36.5 feet, RECOVERY = 100%, RQD = 0%

BEDROCK CORE: I-80 BRIDGE OVER I-55; I-80 RECONSTRUCTION FROM EAST OF RIDGE RD TO HOUBOLT RD, WILL COUNTY, ILLINOIS

SCALE: GRAPHICAL

APPENDIX C-5

DRAWN BY: E. Greenwood
CHECKED BY: A. Hamad



1145 N. Main Street
Lombard, IL 60148
www.wangeng.com

FOR STANTEC

255-39-01

Run #2

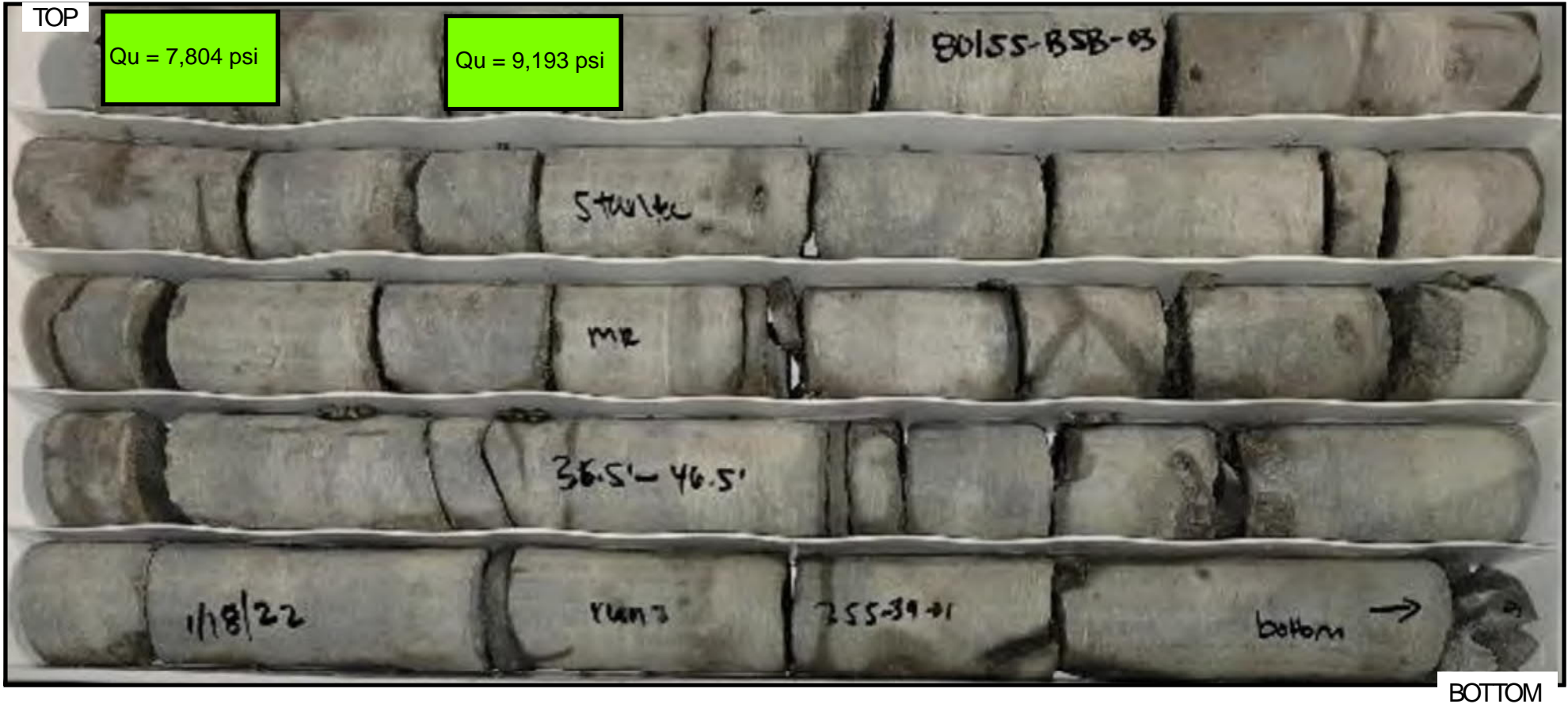

0 6 inches

Boring: 80/55-BSB-03

Run #2, 36.5 to 46.5 feet, RECOVERY = 95%, RQD = 39%

BEDROCK CORE: I-80 BRIDGE OVER I-55; I-80 RECONSTRUCTION FROM EAST OF RIDGE RD TO HOUBOLT RD, WILL COUNTY, ILLINOIS

SCALE: GRAPHICAL

APPENDIX C-6

DRAWN BY: E. Greenwood
CHECKED BY: A. Hamad



1145 N. Main Street
Lombard, IL 60148
www.wangeng.com

FOR STANTEC

255-39-01

Run #1



TOP

BOTTOM

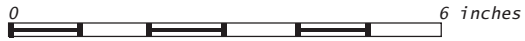

Boring: 80/55-BSB-04
Run #1, 37.0 to 42.0 feet, RECOVERY = 90%, RQD = 23%

BEDROCK CORE: I-80 BRIDGE OVER I-55; I-80 RECONSTRUCTION FROM EAST OF RIDGE RD TO HOUBOLT RD, WILL COUNTY, ILLINOIS

SCALE: GRAPHICAL

APPENDIX C-7

DRAWN BY: E. Greenwood
CHECKED BY: A. Hamad



1145 N. Main Street
Lombard, IL 60148
www.wangeng.com

FOR STANTEC

255-39-01

Run #2



0 6 inches

Boring: 80/55-BSB-04
Run #2, 42.0 to 52.0 feet, RECOVERY = 97%, RQD = 67%

BEDROCK CORE: I-80 BRIDGE OVER I-55; I-80 RECONSTRUCTION FROM EAST OF RIDGE RD TO HOUBOLT RD, WILL COUNTY, ILLINOIS

SCALE: GRAPHICAL

APPENDIX C-8

DRAWN BY: E. Greenwood
CHECKED BY: A. Hamad



1145 N. Main Street
Lombard, IL 60148
www.wangeng.com

FOR STANTEC

255-39-01

Run #1

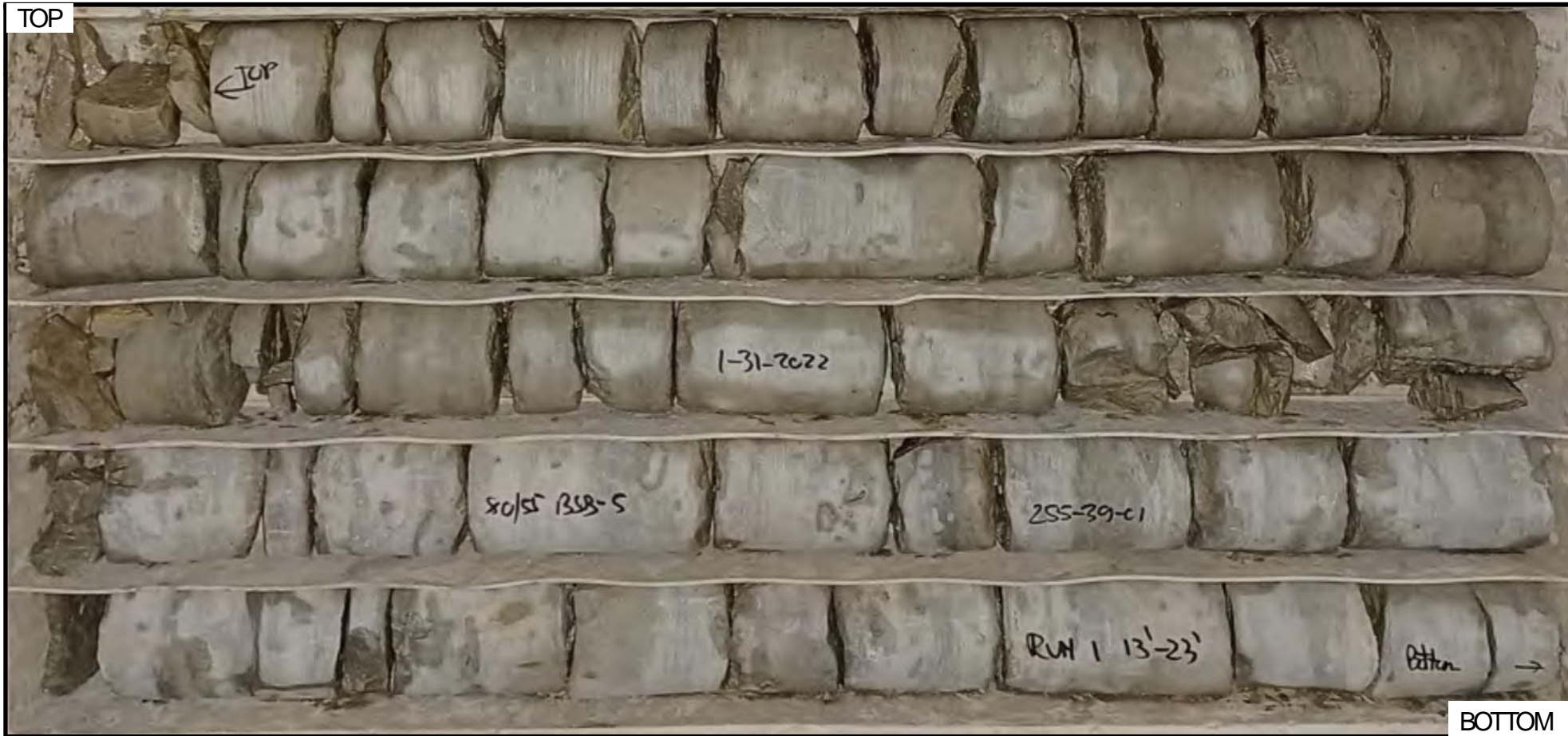

0 6 inches

Boring: 80/55-BSB-05
Run #1, 13.0 to 23.0 feet, RECOVERY = 99%, RQD = 0%

BEDROCK CORE: I-80 BRIDGE OVER I-55; I-80 RECONSTRUCTION FROM EAST OF RIDGE RD TO HOUBOLT RD, WILL COUNTY, ILLINOIS

SCALE: GRAPHICAL APPENDIX C-9 DRAWN BY: E. Greenwood
CHECKED BY: A. Hamad

 **Wang Engineering**
1145 N. Main Street
Lombard, IL 60148
www.wangeng.com

FOR STANTEC 255-39-01

Run #2

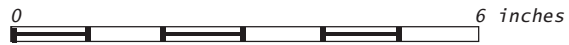

Boring: 80/55-BSB-05
Run #2, 23.0 to 28.0 feet, RECOVERY = 97%, RQD = 63%

BEDROCK CORE: I-80 BRIDGE OVER I-55; I-80 RECONSTRUCTION FROM EAST OF RIDGE RD TO HOUBOLT RD, WILL COUNTY, ILLINOIS

SCALE: GRAPHICAL

APPENDIX C-10

DRAWN BY: E. Greenwood
CHECKED BY: A. Hamad



1145 N. Main Street
Lombard, IL 60148
www.wangeng.com

FOR STANTEC

255-39-01

Run #1

TOP



BOTTOM



Boring: 80/55-BSB-06
 Run #1, 31.0 to 37.0 feet, RECOVERY = 90%, RQD = 6%

BEDROCK CORE: I-80 BRIDGE OVER I-55; I-80 RECONSTRUCTION FROM EAST OF RIDGE RD TO HOUBOLT RD, WILL COUNTY, ILLINOIS

SCALE: GRAPHICAL	APPENDIX C-11	DRAWN BY: E. Greenwood CHECKED BY: A. Hamad
------------------	---------------	--

	1145 N. Main Street Lombard, IL 60148 www.wangeng.com
	FOR STANTEC

255-39-01

Run #2



0 6 inches

Boring: 80/55-BSB-06
Run #2, 37.0 to 47.0 feet, RECOVERY = 93%, RQD = 43%

BEDROCK CORE: I-80 BRIDGE OVER I-55; I-80 RECONSTRUCTION FROM EAST OF RIDGE RD TO HOUBOLT RD, WILL COUNTY, ILLINOIS

SCALE: GRAPHICAL

APPENDIX C-12

DRAWN BY: E. Greenwood
CHECKED BY: A. Hamad



1145 N. Main Street
Lombard, IL 60148
www.wangeng.com

FOR STANTEC

255-39-01

Run #1

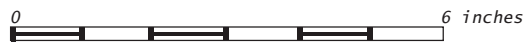

Boring: 80/55-BSB-07
Run #1, 38.0 to 48.0 feet, RECOVERY = 98%, RQD = 18%

BEDROCK CORE: I-80 BRIDGE OVER I-55; I-80 RECONSTRUCTION FROM EAST OF RIDGE RD TO HOUBOLT RD, WILL COUNTY, ILLINOIS		
SCALE: GRAPHICAL	APPENDIX C-13	DRAWN BY: J. Bensen CHECKED BY: A. Hamad
		1145 N. Main Street Lombard, IL 60148 www.wangeng.com
FOR STANTEC		255-39-01

Run #2



Boring 80/55-BSB-07:
Run #2, 48.0 to 53.0 feet, RECOVERY = 100%, RQD = 87%

BEDROCK CORE: I-80 BRIDGE OVER I-55; I-80 RECONSTRUCTION FROM EAST OF RIDGE RD TO HOUBOLT RD, WILL COUNTY, ILLINOIS		
SCALE: GRAPHICAL	APPENDIX C-14	DRAWN BY: E. Greenwood CHECKED BY: A. Hamad
		1145 N. Main Street Lombard, IL 60148 www.wangeng.com
FOR STANTEC		255-39-01

Run #1



Boring: 80/55-BSB-08
Run #1, 12.0 to 22.0 feet, RECOVERY = 98%, RQD = 7%

BEDROCK CORE: I-80 BRIDGE OVER I-55; I-80 RECONSTRUCTION FROM EAST OF RIDGE RD TO HOUBOLT RD, WILL COUNTY, ILLINOIS		
SCALE: GRAPHICAL	APPENDIX C-15	DRAWN BY: E. Greenwood CHECKED BY: A. Hamad
		1145 N. Main Street Lombard, IL 60148 www.wangeng.com
FOR STANTEC		255-39-01

Run #2

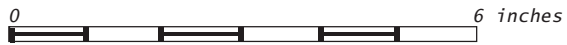

Boring: 80/55-BSB-08
Run #2, 22.0 to 27.0 feet, RECOVERY = 100%, RQD = 35%

BEDROCK CORE: I-80 BRIDGE OVER I-55; I-80 RECONSTRUCTION FROM EAST OF RIDGE RD TO HOUBOLT RD, WILL COUNTY, ILLINOIS

SCALE: GRAPHICAL

APPENDIX C-16

DRAWN BY: E. Greenwood
CHECKED BY: A. Hamad



1145 N. Main Street
Lombard, IL 60148
www.wangeng.com

FOR STANTEC

255-39-01

Run #1

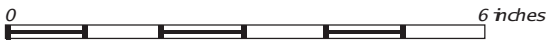

Boring: 80/55-BSB-09
Run #1, 32.0 to 42.0 feet, RECOVERY = 91%, RQD = 32%

BEDROCK CORE: I-80 BRIDGE OVER I-55; I-80 RECONSTRUCTION FROM EAST OF RIDGE RD TO HOUBOLT RD, WILL COUNTY, ILLINOIS

SCALE: GRAPHICAL

APPENDIX C-17

DRAWN BY: E. Greenwood
CHECKED BY: A. Hamad



1145 N. Main Street
Lombard, IL 60148
www.wangeng.com

FOR STANTEC

255-39-01

RUN #2



0 6 inches

Boring: 80/55-BSB-09
Run #2, 42.0 to 47.0 feet, RECOVERY = 93%, RQD = 93%

BEDROCK CORE: I-80 BRIDGE OVER I-55; I-80 RECONSTRUCTION FROM EAST OF RIDGE RD TO HOUBOLT RD, WILL COUNTY, ILLINOIS

SCALE: GRAPHICAL

APPENDIX C-18

DRAWN BY: E. Greenwood
CHECKED BY: A. Hamad



1145 N. Main Street
Lombard, IL 60148
www.wangeng.com

FOR STANTEC

255-39-01

APPENDIX D

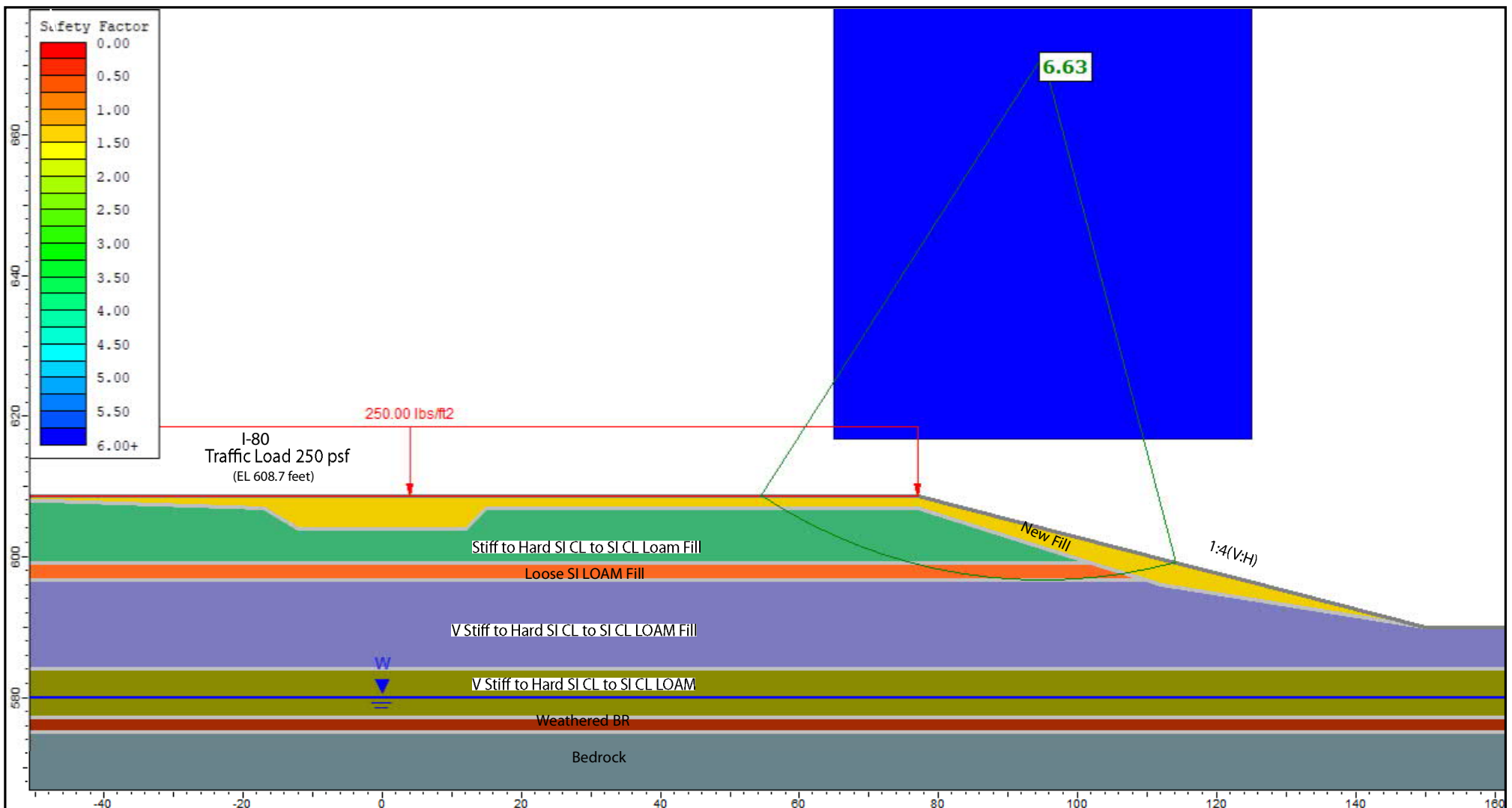

Undrained Analysis, East Abutment Side Slope, Ref Boring: 80/55-BSB-03, 80/55-BSB-06, and 80/55-BSB-09

Layer ID	Description	Total Unit Weight (pcf)	Undrained Cohesion (psf)	Undrained Friction Angle (degrees)
1	New Fill	125	1000	0
2	V Stiff to Hard SI CL to SI CL Loam Fill	120	1700	0
3	Loose SI LOAM Fill	115	0	28
4	V Stiff to Hard SI CL to SI CL LOAM	120	3000	0
5	Weathered Bedrock	125	0	35

GLOBAL STABILITY: I-80 OVER I-55 BRIDGE; I-80 RECONSTRUCTION FROM EAST OF RIDGE RD TO HOUBOLT ROAD, WILL COUNTY, ILLINOIS

SCALE: GRAPHICAL | APPENDIX D-1 | DRAWN BY: N. Balakumaran
CHECKED BY: A. Hamad



1145 N. Main Street
Lombard, IL 60148
www.wangeng.com

FOR STANTEC | 255-39-01

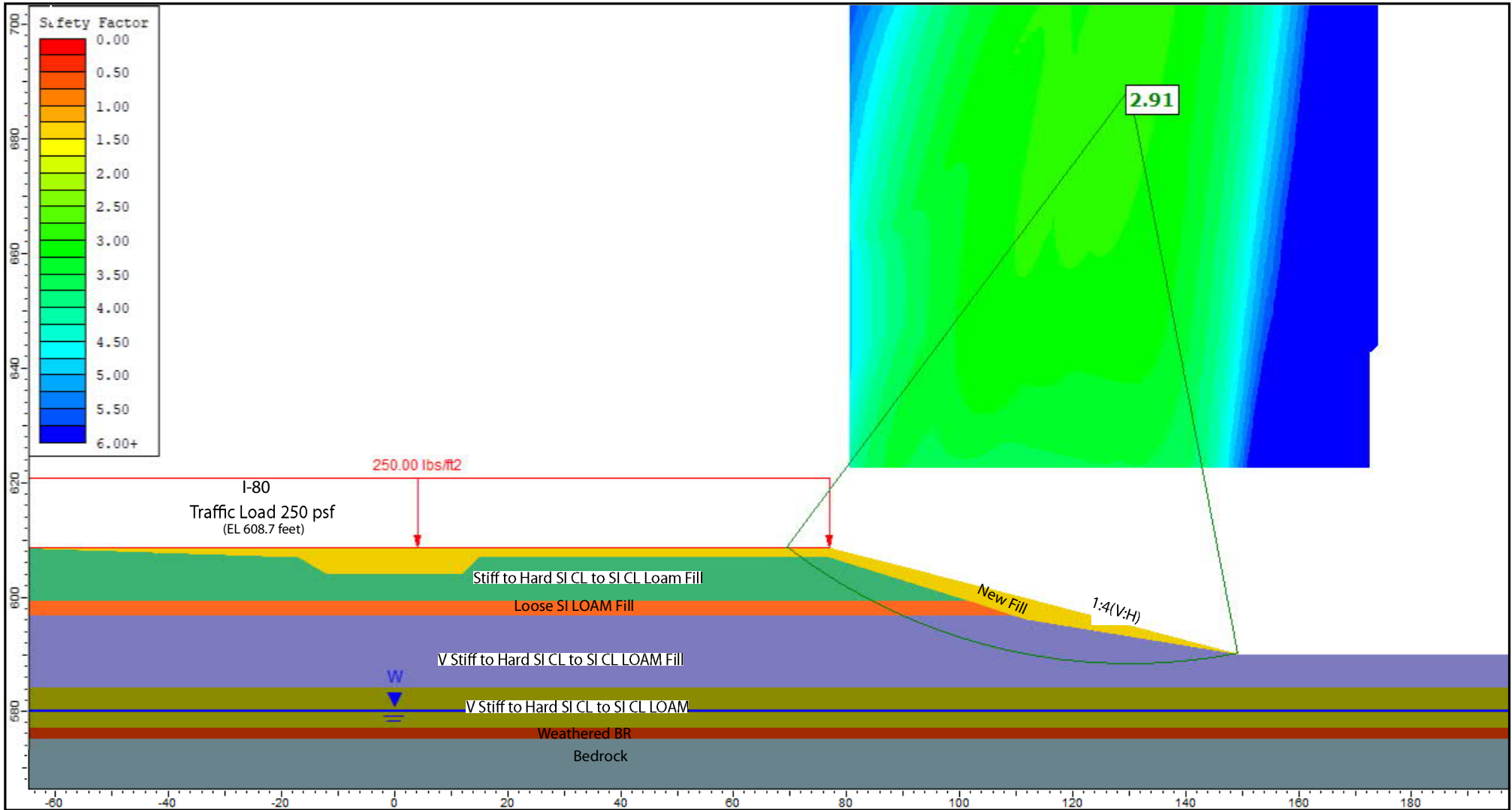

Drained Analysis, East Abutment Side Slope, Ref Boring: 80/55-BSB-03, 80/55-BSB-06, and 80/55-BSB-09

Layer ID	Description	Total Unit Weight (pcf)	Drained Cohesion (psf)	Drained Friction Angle (degrees)
1	New Fill	125	100	30
2	V Stiff to Hard SI CL to SI CL Loam Fill	120	100	30
3	Loose SI LOAM Fill	115	0	28
4	V Stiff to Hard SI CL to SI CL LOAM	120	100	30
5	Weathered Bedrock	125	0	35

GLOBAL STABILITY: I-80 OVER I-55 BRIDGE; I-80 RECONSTRUCTION FROM EAST OF RIDGE RD TO HOUBOLT ROAD, WILL COUNTY, ILLINOIS

SCALE: GRAPHICAL

APPENDIX D-2

DRAWN BY: N. Balakumaran
CHECKED BY: A. Hamad



1145 N. Main Street
Lombard, IL 60148
www.wangeng.com

FOR STANTEC

255-39-01

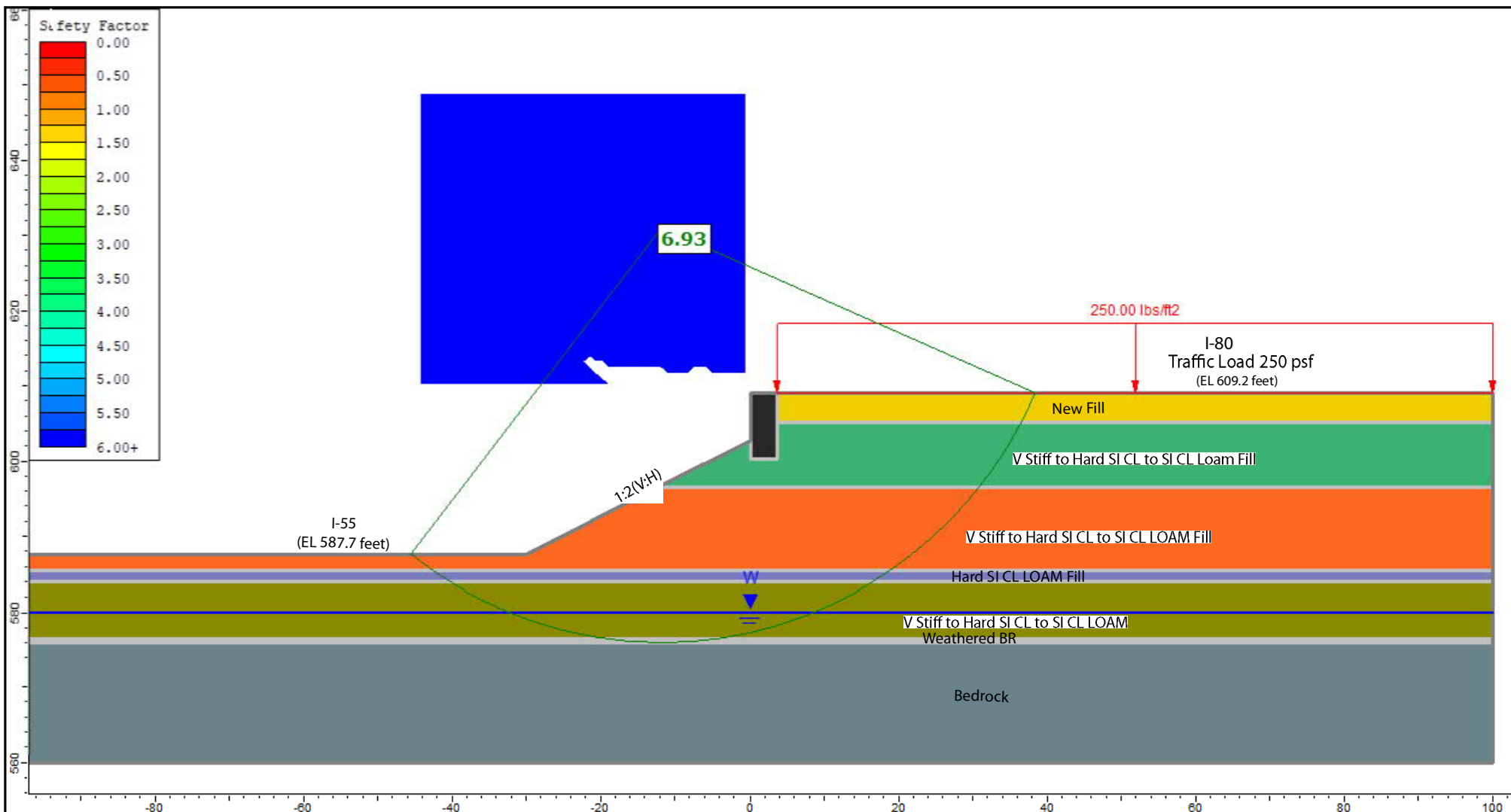

Undrained Analysis, East Abutment End Slope, Ref Boring: 80/55-BSB-03, 80/55-BSB-06, and 80/55-BSB-09

Layer ID	Description	Total Unit Weight (pcf)	Undrained Cohesion (psf)	Undrained Friction Angle (degrees)
1	New Fill	125	1000	0
2	V Stiff to Hard SI CL to SI CL Loam Fill	120	4000	0
3	V Stiff to Hard SI CL to SI CL LOAM Fill	120	3000	0
4	Hard SI CL LOAM FILL	120	4000	0
5	V Stiff to Hard SI CL to SI CL LOAM	120	4000	0
6	Weathered BR	125	0	35

GLOBAL STABILITY: I-80 OVER I-55 BRIDGE; I-80 RECONSTRUCTION FROM EAST OF RIDGE RD TO HOUBOLT ROAD, WILL COUNTY, ILLINOIS

SCALE: GRAPHICAL APPENDIX D-3 DRAWN BY: N. Balakumaran
CHECKED BY: A. Hamad

Wang Engineering
1145 N. Main Street
Lombard, IL 60148
www.wangeng.com

FOR STANTEC 255-39-01

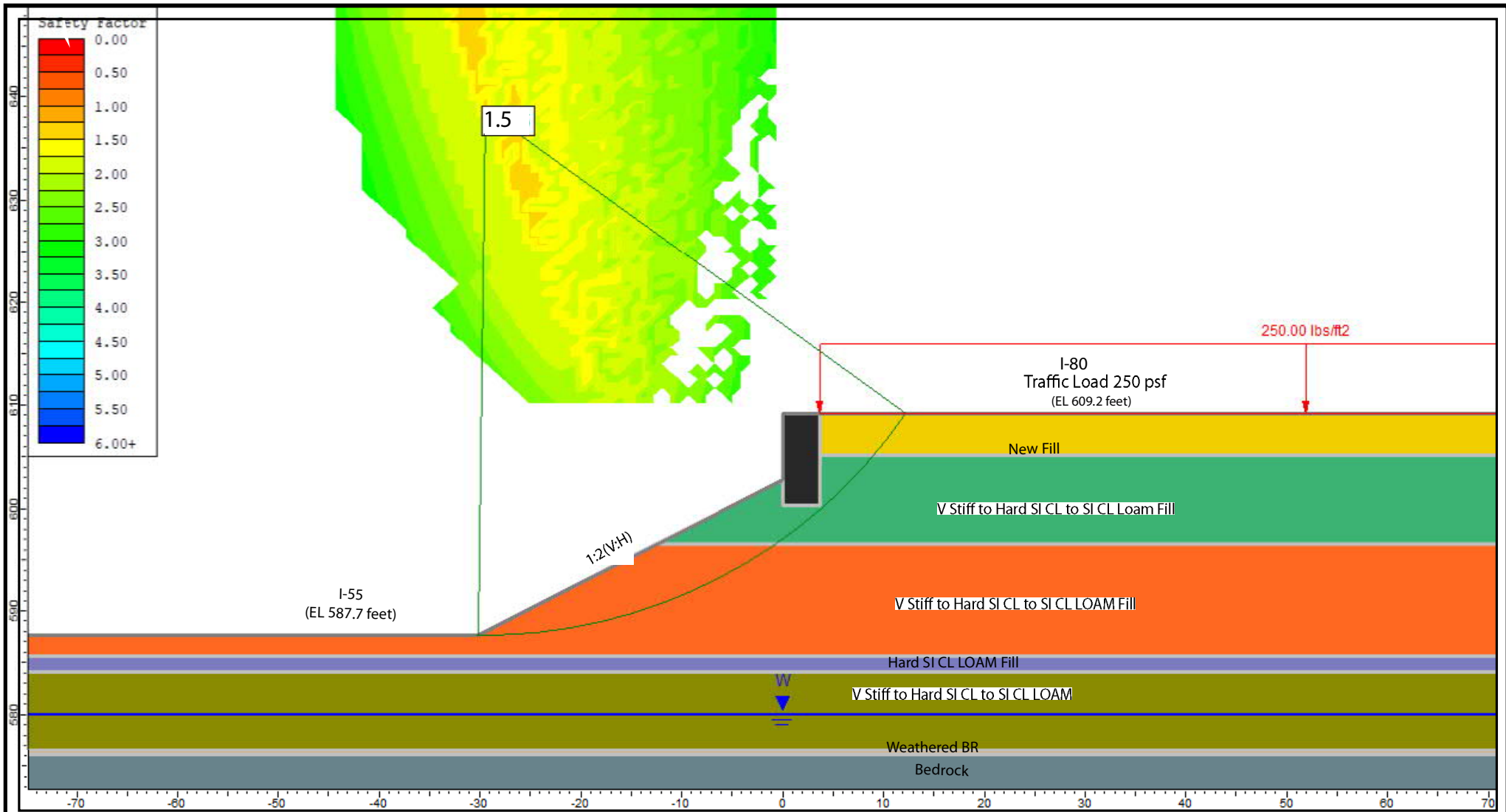

Drained Analysis, East Abutment End Slope, Ref Boring: 80/55-BSB-03, 80/55-BSB-06, and 80/55-BSB-09

Layer ID	Description	Total Unit Weight (pcf)	Drained Cohesion (psf)	Drained Friction Angle (degrees)
1	New Fill	125	100	30
2	V Stiff to Hard SI CL to SI CL Loam Fill	120	100	30
3	V Stiff to Hard SI CL to SI CL LOAM Fill	120	100	30
4	Hard SI CL LOAM FILL	120	100	30
5	V Stiff to Hard SI CL to SI CL LOAM	120	100	30
6	Weathered BR	125	0	35

GLOBAL STABILITY: I-80 OVER I-55 BRIDGE; I-80 RECONSTRUCTION FROM EAST OF RIDGE RD TO HOUBOLT ROAD, WILL COUNTY, ILLINOIS

SCALE: GRAPHICAL

APPENDIX D-4

DRAWN BY: N. Balakumaran
CHECKED BY: A. Hamad



1145 N. Main Street
Lombard, IL 60148
www.wangeng.com

FOR STANTEC

255-39-01

APPENDIX E

Benchmark: Set 2" CWA aluminum disc in south side of concrete base of overhead highway sign "Exit 126A" "Exit 126B" on north side of westbound I-80, approximately 1 mile east of I-55 centerline. Elev. 572.739

Existing Structure: S.N. 099-0044 E.B. and S.N. 099-0045 W.B. Built in 1960 as F.A.I. Rte. 80, Section 99-1HB-2 & 99-1HF-2, at Sta. 1949+18.73. Existing dual structures each consist of 4-span reinforced concrete deck on steel rolled shape girders supported by pile bent abutments and multi-column piers. Length is 239'-4" Back to Back abutments, width varies from 51'-2" to 55'-1 7/8". Structures to be removed and replaced.

Traffic Control: Traffic to be maintained utilizing staged construction.

No Salvage.

HIGHWAY CLASSIFICATION

FAI Rte. 80 - I-80	FAI Rte. 55 - I-55
Functional Class: Interstate	Functional Class: Interstate
ADT: 49,400 (2019); 69,600 (2040)	ADT: 63,300 (2017); 84,900 (2040)
ADTT: 15,800 (2019); 22,260 (2040)	ADTT: 15,380 (2017); 20,630 (2040)
DHV: 8350 (2040)	DHV: 10200 (2040)
Design Speed: 70 m.p.h.	Design Speed: 70 m.p.h.
Posted Speed: 65 m.p.h.	Posted Speed: 65 m.p.h.
Two-Way Traffic	Two-Way Traffic
Directional Distribution: 50:50	Directional Distribution: 50:50

LOADING HL-93

Allow 50#/sq. ft. for future wearing surface.

DESIGN SPECIFICATIONS

2020 AASHTO LRFD Bridge Design Specifications, 9th Edition

DESIGN STRESSES

FIELD UNITS
 f_c = 3,500 psi
 f_c = 4,000 psi (Superstructure)
 f_y = 60,000 psi (Reinforcement)
 f_y = 50,000 psi (M270 Grade 50)
 All Structural Steel shall be metalized

SEISMIC DATA

Seismic Performance Zone (SPZ) = 1
 Design Spectral Acceleration at 1.0 sec. (SD1) = 0.068g
 Design Spectral Acceleration at 0.2 sec. (SDS) = 0.127g
 Soil Site Class = C

MODEL: Default
 FILE NAME: pw://transystems-pw.bentley.com/transystems-pw1-hosted/Documents/Projects_2018/CH401/401180022/01-Structures/04-Sheets/04-Sheets/099-8316&8317-R2R28-TSL-001.dgn

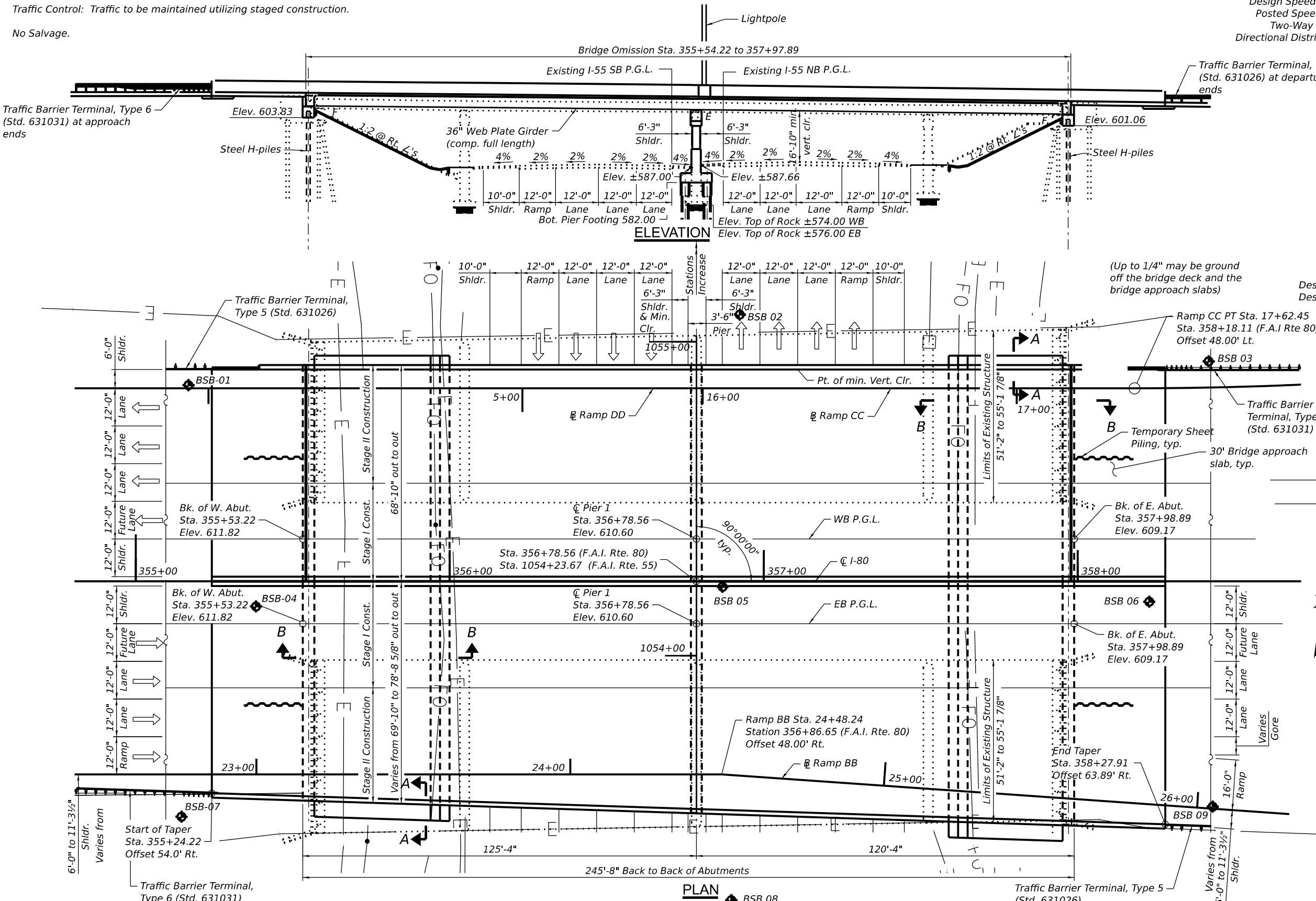

LEGEND

- E - Existing Electrical Line
- FO - Existing Fiber Optic Line
- ◆ - Soil Boring

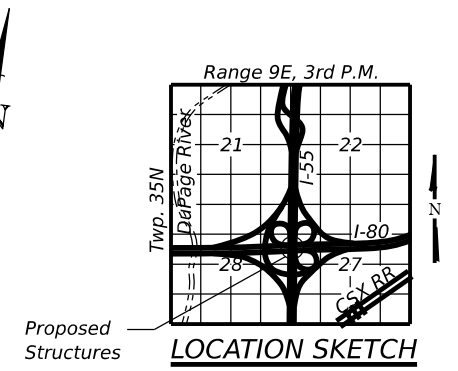

GENERAL PLAN AND ELEVATION
I-80 OVER I-55
F.A.I. ROUTE 80 - SEC. 2021-154-R
WILL COUNTY
STA. 356+78.56
STRUCTURE NO. 099-8316 (E.B.)
STRUCTURE NO. 099-8317 (W.B.)



USER NAME = dschrijks...	DESIGNED - CRS	REVISED -
PLOT SCALE = 32,0000...Lin	CHECKED - DTS	REVISED -
PLOT DATE = 8/8/2022	DRAWN - CRS	REVISED -
	CHECKED - DTS	REVISED -

STATE OF ILLINOIS
DEPARTMENT OF TRANSPORTATION

F.A.I. RTE.	SECTION	COUNTY	TOTAL SHEETS	SHEET NO.
80	2021-154-R	WILL	5	1
CONTRACT NO. 62R28				
ILLINOIS FED. AID PROJECT				

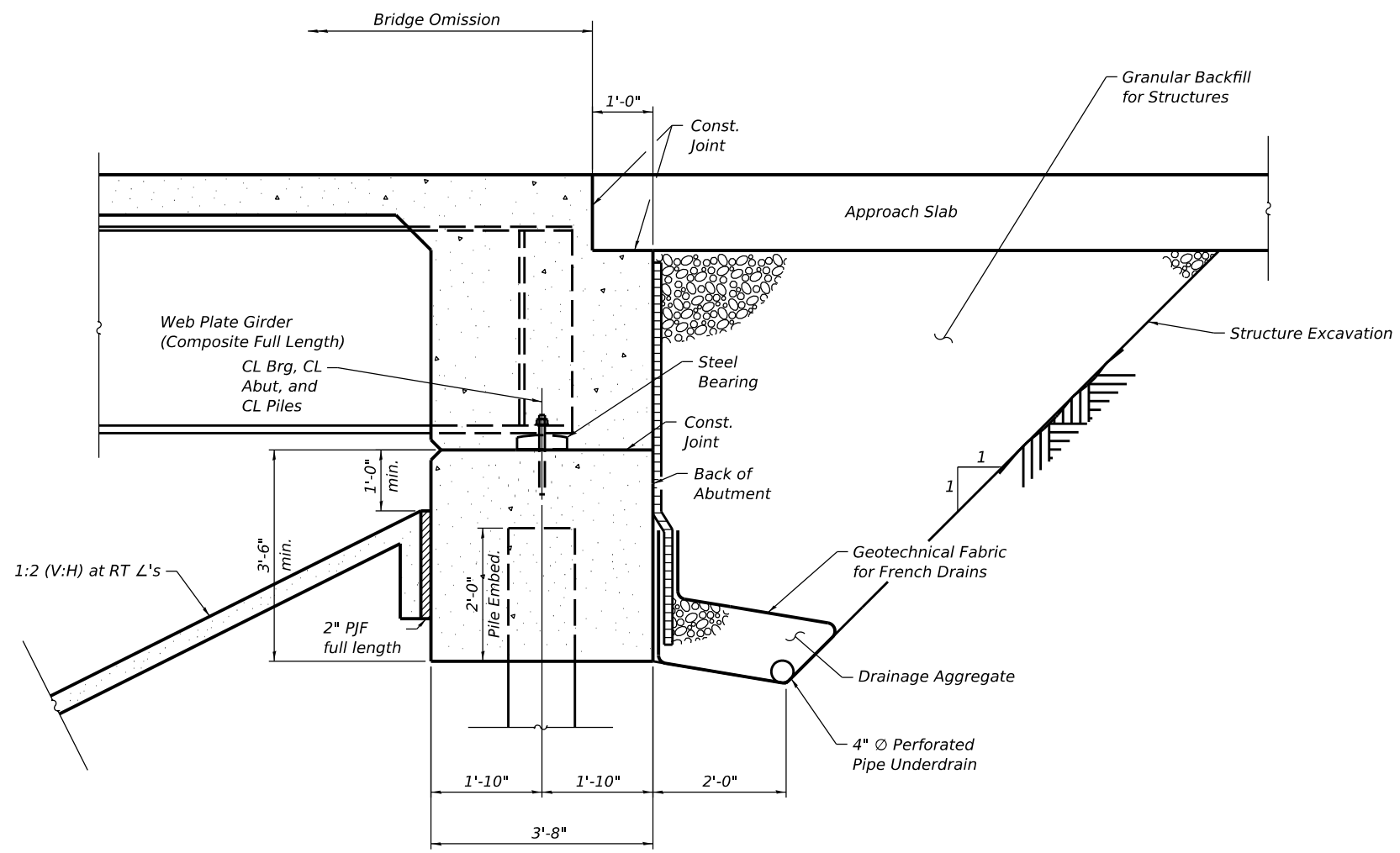

CURVE DATA

(Ramp CC)
 Curve PR_CC-06
 P.I. Sta. = 16+94.38
 $\Delta = 6^\circ 38' 27''$ (RT)
 $D = 4^\circ 52' 20''$
 $R = 1,176.00'$
 $T = 68.23'$
 $L = 136.30'$
 $E = 1.98'$
 $e = 4.90\%$
 $T.R. = N/A$
 $S.E. Run = 72'$
 $P.C. Sta. = 16+26.15$
 $P.T. Sta. = 17+62.45$
 Design Speed = 40 m.p.h.

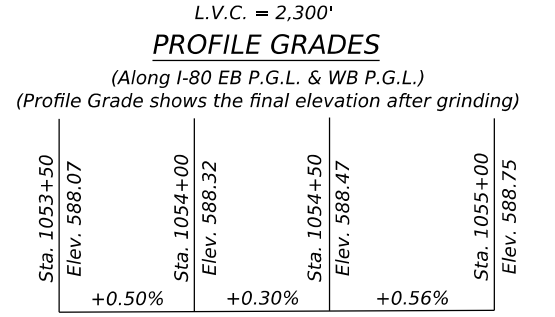
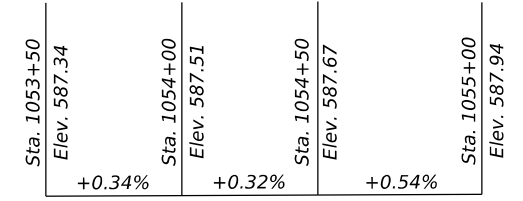
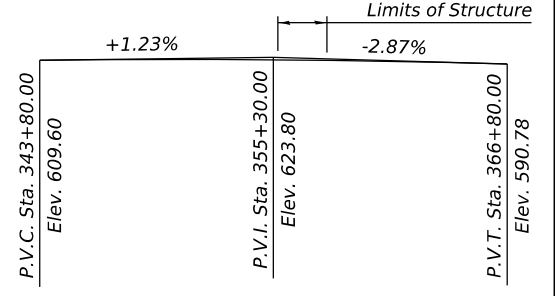

PROFILE GRADES
(Along Existing I-55 SB P.G.L.)

PROFILE GRADES
(Along Existing I-55 NB P.G.L.)

SECTION THRU INTEGRAL ABUTMENT

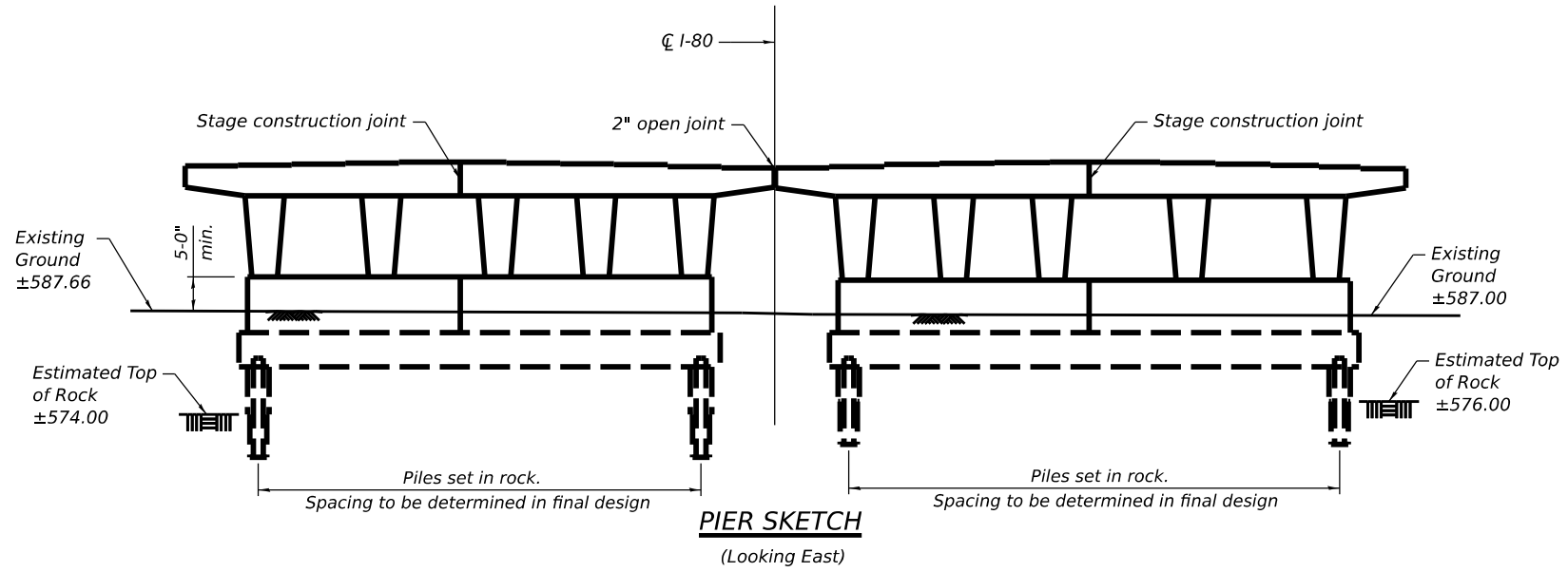
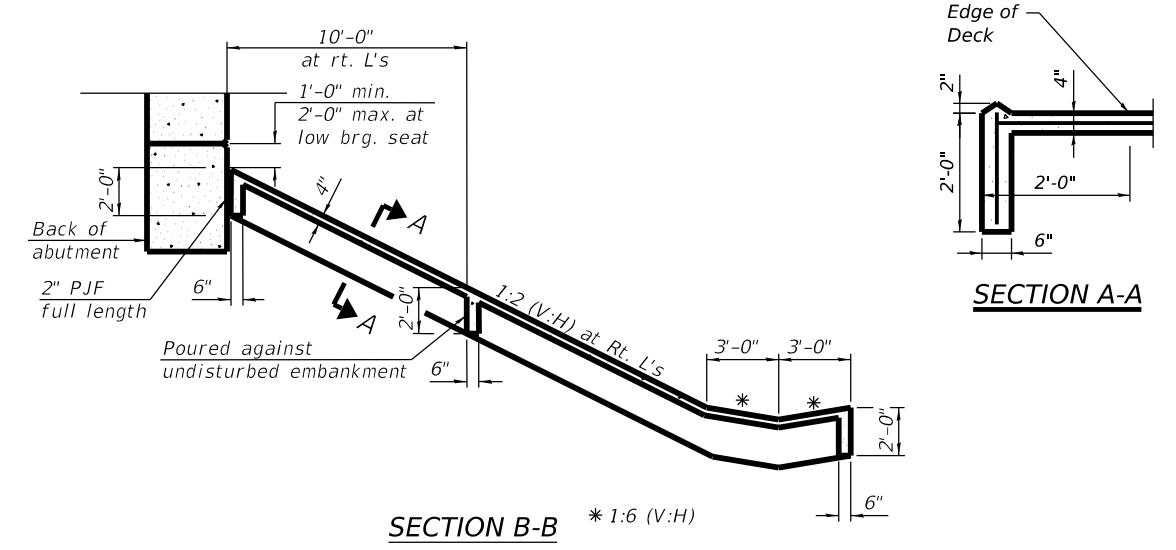

SUBSTRUCTURE DETAILS & PROFILES
I-80 OVER I-55
F.A.I. ROUTE 80 - SEC. 2021-154-R
WILL COUNTY
STATION 356+78.56
STRUCTURE NO. 099-8316 (E.B.)
STRUCTURE NO. 099-8317 (W.B.)

MODEL: \$MODELNAME\$.
 FILE NAME: \$FILES\$



USER NAME = \$USER\$	DESIGNED - CRS	REVISED -
PLOT SCALE = \$SCALE\$	CHECKED - DTS	REVISED -
PLOT DATE = \$DATE\$	DRAWN - CRS	REVISED -
	CHECKED - DTS	REVISED -

STATE OF ILLINOIS
DEPARTMENT OF TRANSPORTATION

SHEET 2 OF 5 SHEETS

F.A.I. RTE.	SECTION	COUNTY	TOTAL SHEETS	SHEET NO.
80	2021-154-R	WILL	5	2
CONTRACT NO. 62R28				
ILLINOIS FED. AID PROJECT				

MODEL: Sheet
 FILE NAME: p:\projects\transys\corp-pw\1-hosted\Documents\Projects_2018\CH401\401180022\01-Structures\04-Sheets\04-Structures\099-8316&8317-R2R28-TSL-003.dgn

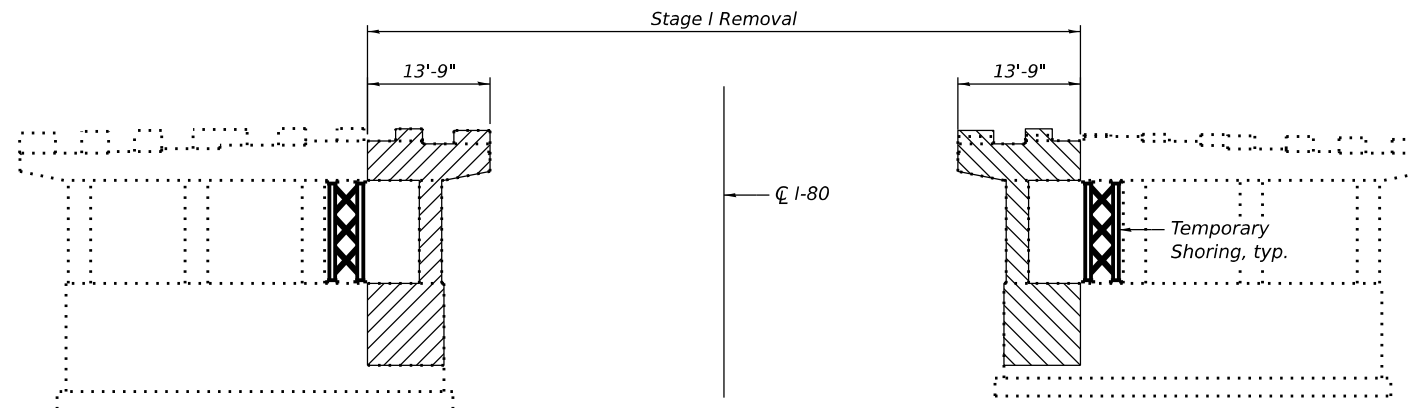

STAGE I REMOVAL

(Looking East)

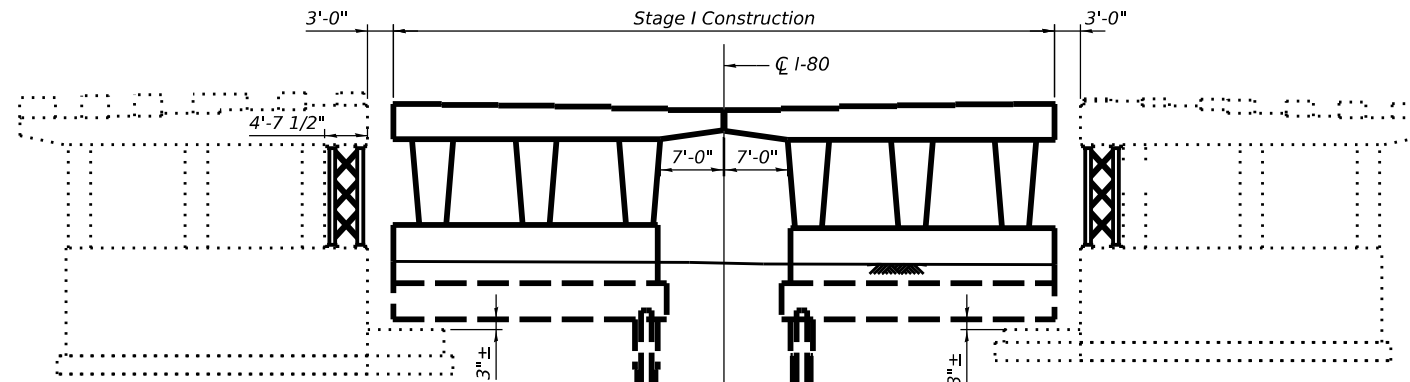

STAGE I CONSTRUCTION

(Looking East)

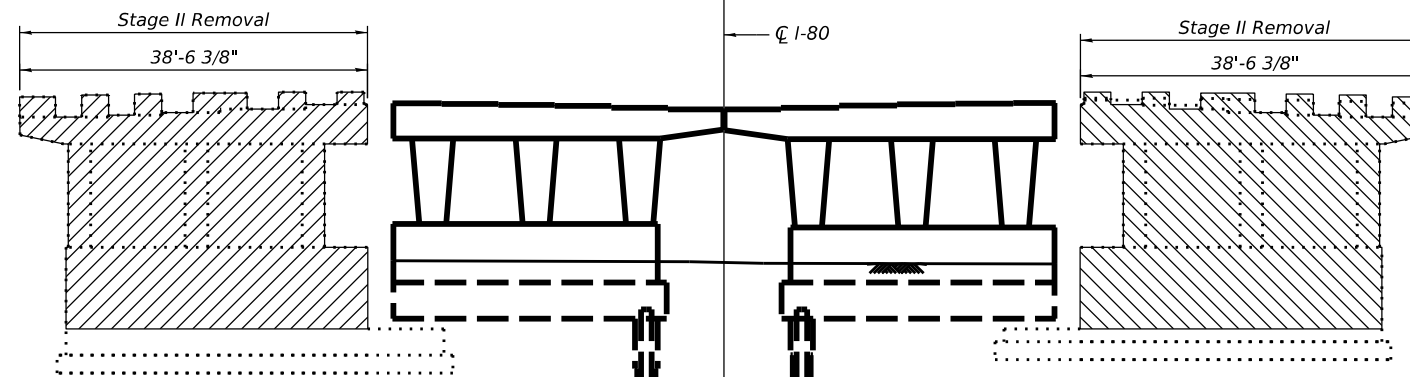

STAGE II REMOVAL

(Looking East)

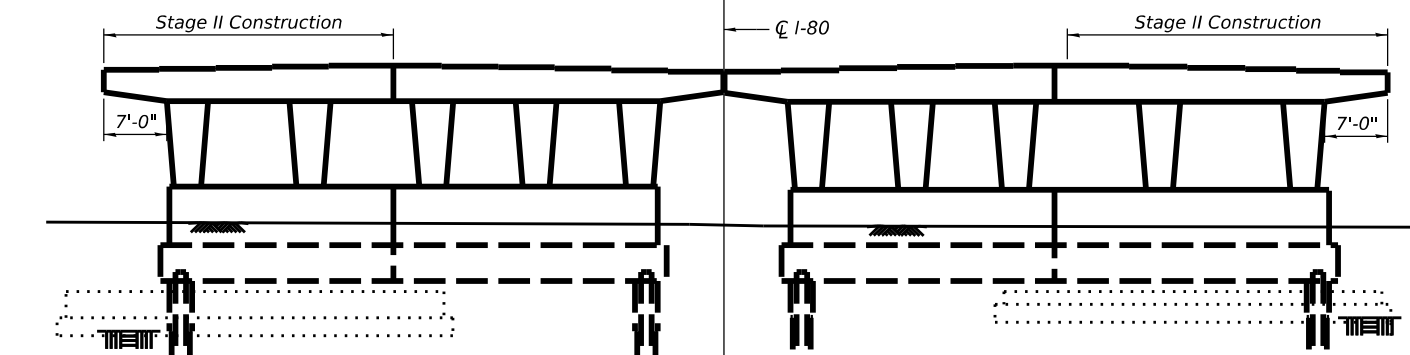

STAGE II CONSTRUCTION

(Looking East)

NOTE:

If Contractor elects, existing pier 1 and 3 need only be removed to 1 foot below the proposed superstructure in stage 1. Remaining portion of pier specified to be removed can be performed in stage 2.

LEGEND

Removal

PIER REMOVAL AND CONSTRUCTION

I-80 OVER I-55

F.A.I. ROUTE 80 - SEC. 2021-154-R

WILL COUNTY

STATION 356+78.56

STRUCTURE NO. 099-8316 (E.B.)

STRUCTURE NO. 099-8317 (W.B.)



USER NAME = dschrijks_	DESIGNED - CRS	REVISED -
PLOT SCALE = 0.1667' = 1"	CHECKED - DTS	REVISED -
PLOT DATE = 8/8/2022	DRAWN - CRS	REVISED -
	CHECKED - DTS	REVISED -

**STATE OF ILLINOIS
 DEPARTMENT OF TRANSPORTATION**

SHEET 3 OF 5 SHEETS

F.A.I. RTE.	SECTION	COUNTY	TOTAL SHEETS	SHEET NO.
80	2021-154-R	WILL	5	3
CONTRACT NO. 62R28				
ILLINOIS FED. AID PROJECT				

MODEL: Sheet
 FILE NAME: pw://transsystems-pw.bentley.com/transyscorp-pw1-hosted/Documents/Projects_2018/CH401/401180022/01-Structures/04-Sheets/04-Structures/099-8316&8317-R2R28-TSL-004.dgn

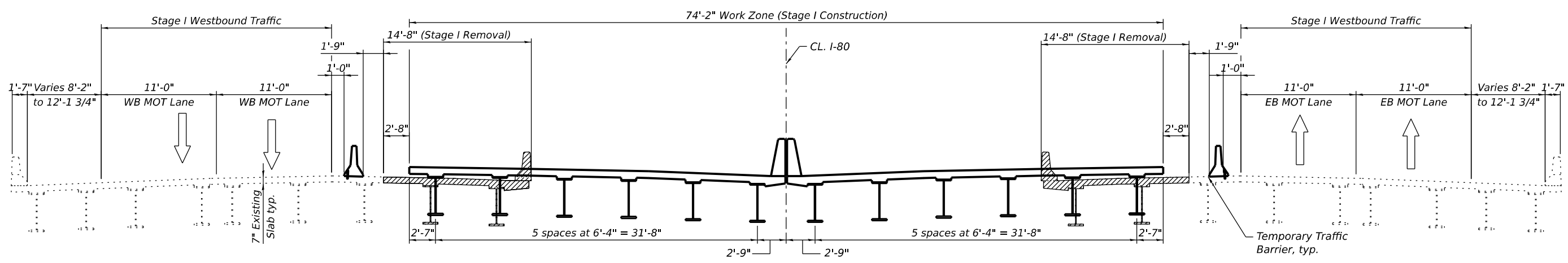

STAGE I REMOVAL AND RECONSTRUCTION
(Looking East)

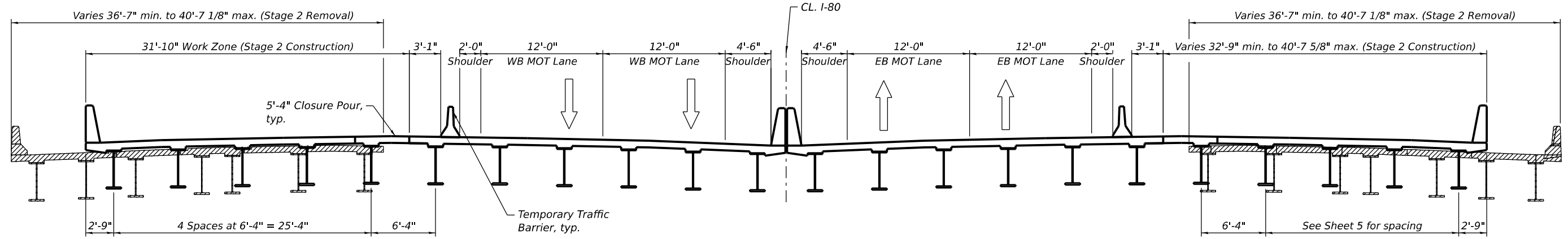

STAGE 2 REMOVAL AND RECONSTRUCTION
(Looking East)

LEGEND
 Denotes Superstructure Removal

SUPERSTRUCTURE CONSTRUCTION STAGING
I-80 OVER I-55
F.A. ROUTE 80 - SEC. 2021-154-R
WILL COUNTY
STATION 356+78.56
STRUCTURE NO. 099-8316 (E.B.)
STRUCTURE NO. 099-8317 (W.B.)



USER NAME = dschrijks_	DESIGNED - HMH	REVISED -
PLOT SCALE = 0.1667:1	CHECKED - DTS	REVISED -
PLOT DATE = 8/8/2022	DRAWN - HMH	REVISED -
	CHECKED - DTS	REVISED -

STATE OF ILLINOIS
DEPARTMENT OF TRANSPORTATION

SHEET 4 OF 5 SHEETS

F.A.I. RTE.	SECTION	COUNTY	TOTAL SHEETS	SHEET NO.
80	2021-154-R	WILL	5	4
CONTRACT NO. 62R28				
ILLINOIS FED. AID PROJECT				

MODEL: Sheet
 FILE NAME: p:\projects\transys\transys\pw1-hosted\Documents\Projects_2018\CH401\401180022\01-Structures\04-Sheets\04-Sheets\04_62R28\04-Sheets\CAD\ML-04_62R28\04-Sheets\CAD\ML-04_62R28-TSL-005.dgn

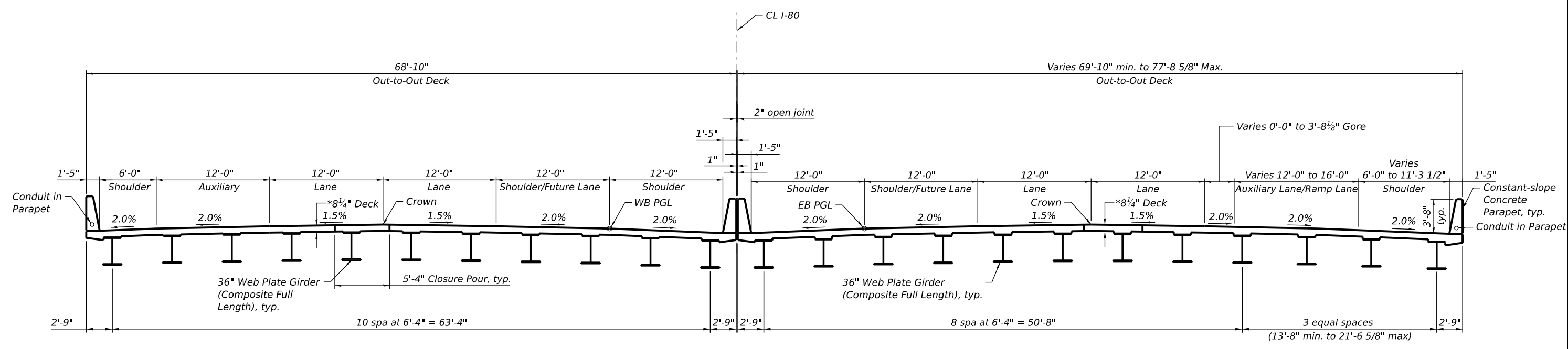

*Prior to Grinding

PROPOSED CROSS-SECTION
 (Looking East)

PROPOSED CROSS SECTION
I-80 OVER I-55
F.A. ROUTE 80 - SEC. 2021-154-R
WILL COUNTY
STATION 356+78.56
STRUCTURE NO. 099-8316 (E.B.)
STRUCTURE NO. 099-8317 (W.B.)



USER NAME = dschrijks_	DESIGNED - HMH	REVISED -
PLOT SCALE = 0.2" = 1'-0"	CHECKED - DTS	REVISED -
PLOT DATE = 8/8/2022	DRAWN - HMH	REVISED -
	CHECKED - DTS	REVISED -

STATE OF ILLINOIS
 DEPARTMENT OF TRANSPORTATION

F.A.I. RTE.	SECTION	COUNTY	TOTAL SHEETS	SHEET NO.
80	2021-154-R	WILL	5	5
CONTRACT NO. 62R28				
ILLINOIS FED. AID PROJECT				

APPENDIX F

FINAL SURVEY	SURVEYED	DATE
NOTE BOOK	PLOTTED	
NO.	TEMPLATE	
	AREAS	
	CHECKED	

ORIGINAL SURVEY	SURVEYED	DATE
NOTE BOOK	PLOTTED	
NO.	TEMPLATE	
	AREAS	
	CHECKED	

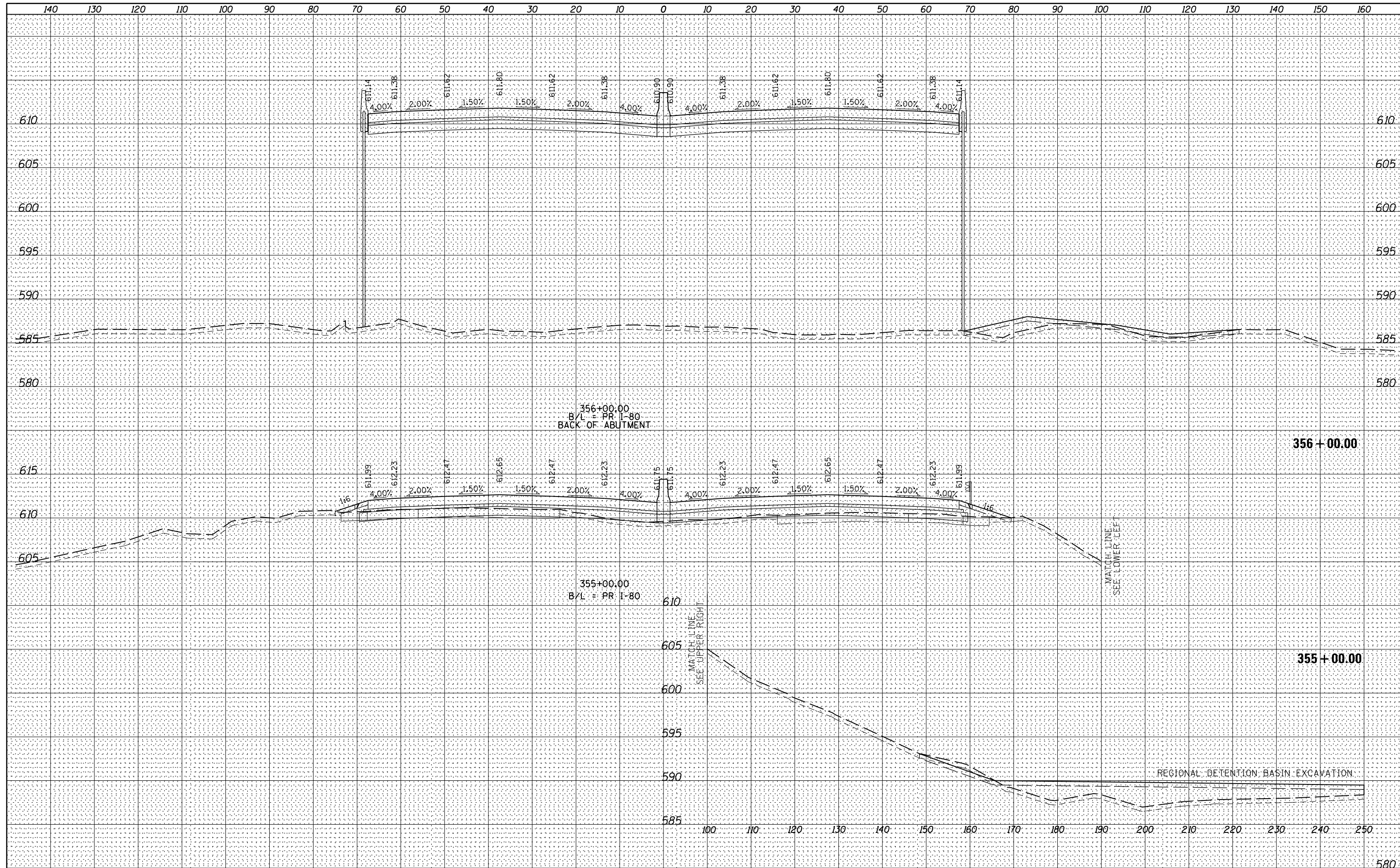

FILE NAME =	USER NAME = mostafan	DESIGNED - BAJ	REVISIED -	STATE OF ILLINOIS DEPARTMENT OF TRANSPORTATION	ILR - I-80 FROM RIDGE ROAD TO US ROUTE 30 I-80 PROPOSED CROSS SECTIONS			F.A. RTÉ.	SECTION	COUNTY	TOTAL SHEETS	SHEET NO.	
dl46314-sht-ILR-180-XSec1.dgn		DRAWN - BAJ	REVISIED -		SCALE: 10 H : 5 V	SHEET 84	OF 352 SHEETS	STA. 355+00.00	TO STA. 356+00.00			352	84
		CHECKED - MAM	REVISIED -		CONTRACT NO.								
		DATE - 10/11/2019	REVISIED -		ILLINOIS FED. AID PROJECT								

